



**HENNY PENNY®**

*Global Foodservice Solutions*

# Henny Penny Evolution Elite™

**Reduced Oil Capacity Open Fryers  
(Split Vat & Full Vat– Electric)**

**Model EEE-141**

**Model EEE-142**

**Model EEE-143**

**Model EEE-144**

# **OPERATOR'S MANUAL**

**REGISTER WARRANTY ONLINE AT [WWW.HENNYPENNY.COM](http://WWW.HENNYPENNY.COM)**



## **LIMITED WARRANTY FOR HENNY PENNY EQUIPMENT**

Subject to the following conditions, Henny Penny Corporation makes the following limited warranties to the original purchaser only for Henny Penny appliances and replacement parts:

**NEW EQUIPMENT:** Any part of a new appliance, except baskets, lamps, and fuses, which proves to be defective in material or workmanship within two (2) years from date of original installation, will be repaired or replaced without charge F.O.B. factory, Eaton, Ohio, or F.O.B. authorized distributor. Baskets will be repaired or replaced for ninety (90) days from date of original installation. Lamps and fuses are not covered under this Limited Warranty. To validate this warranty, the registration card for the appliance must be mailed to Henny Penny within ten (10) days after installation.

**FILTER SYSTEM:** Failure of any parts within a fryer filter system caused by the use of the non-OEM filters or other unapproved filters is not covered under this Limited Warranty.

**REPLACEMENT PARTS:** Any appliance replacement part, except lamps and fuses, which proves to be defective in material or workmanship within ninety (90) days from date of original installation will be repaired or replaced without charge F.O.B. factory, Eaton, Ohio, or F.O.B. authorized distributor.

The warranty for new equipment covers the repair or replacement of the defective part and includes labor charges and maximum mileage charges of 200 miles round trip for a period of one (1) year from the date of original installation.

The warranty for replacement parts covers only the repair or replacement of the defective part and does not include any labor charges for the removal and installation of any parts, travel, or other expenses incidental to the repair or replacement of a part.

**EXTENDED FRYPOT WARRANTY:** Henny Penny will replace any frypot that fails due to manufacturing or workmanship issues for a period of up to seven (7) years from date of manufacture. This warranty shall not cover any frypot that fails due to any misuse or abuse, such as heating of the frypot without shortening.

**0 TO 3 YEARS:** During this time, any frypot that fails due to manufacturing or workmanship issues will be replaced at no charge for parts, labor, or freight. Henny Penny will either install a new frypot at no cost or provide a new or reconditioned replacement fryer at no cost.

**3 TO 7 YEARS:** During this time, any frypot that fails due to manufacturing or workmanship issues will be replaced at no charge for the frypot only. Any freight charges and labor costs to install the new frypot as well as the cost of any other parts replaced, such as insulation, thermal sensors, high limits, fittings, and hardware, will be the responsibility of the owner.

Any claim must be presented to either Henny Penny or the distributor from whom the appliance was purchased. No allowance will be granted for repairs made by anyone else without Henny Penny's written consent. If damage occurs during shipping, notify the sender at once so that a claim may be filed.

THE ABOVE LIMITED WARRANTY SETS FORTH THE SOLE REMEDY AGAINST HENNY PENNY FOR ANY BREACH OF WARRANTY OR OTHER TERM. BUYER AGREES THAT NO OTHER REMEDY (INCLUDING CLAIMS FOR ANY INCIDENTAL OR CONSEQUENTIAL DAMAGES) SHALL BE AVAILABLE.

The above limited warranty does not apply (a) to damage resulting from accident, alteration, misuse, or abuse; (b) if the equipment's serial number is removed or defaced; or (c) for lamps and fuses. THE ABOVE LIMITED WARRANTY IS EXPRESSLY IN LIEU OF ALL OTHER WARRANTIES, EXPRESS OR IMPLIED, INCLUDING MERCHANTABILITY AND FITNESS, AND ALL OTHER WARRANTIES ARE EXCLUDED. HENNY PENNY NEITHER ASSUMES NOR AUTHORIZES ANY PERSON TO ASSUME FOR IT ANY OTHER OBLIGATION OR LIABILITY.

Revised 01/01/07

**TABLE OF CONTENTS**

<b>Section</b>		<b>Page</b>
Section 1.	<b>INTRODUCTION</b> .....	1-1
	1-1 Introduction .....	1-1
	1-2 Proper Care .....	1-1
	1-3 Assistance .....	1-1
	1-4 Safety .....	1-2
Section 2.	<b>INSTALLATION</b> .....	2-1
	2-1 Introduction .....	2-1
	2-2 Unpacking .....	2-1
	2-3 Selecting the Fryer Location .....	2-2
	2-4 Leveling the Fryer .....	2-2
	2-5 Ventilation of Fryer .....	2-3
	2-6 Electrical Requirements .....	2-3
	2-7 Dimensions .....	2-5
Section 3.	<b>OPERATION</b> .....	3-1
	3-1 Operating Components .....	3-1
	3-2 Set-Up Mode .....	3-5
	3-3 Filling or Adding Oil .....	3-6
	3-4 Morning Start-Up Procedures .....	3-7
	3-5 Basic Operation .....	3-8
	3-6 Idle Mode .....	3-8
	3-7 Oil Guardian™ (Auto Top-Off) .....	3-9
	3-8 Selecting Product with Different Setpoint .....	3-9
	3-9 Replacing the JIB .....	3-9
	3-10 Model EEE-141 Oil Reservoir .....	3-10
	3-11 SmartFilter Express™ .....	3-11
	3-12 Daily Filtering .....	3-13
	3-13 Discarding Oil from Vat Using Optional Discard Shuttle .....	3-16
	3-14 Operation Instructions for Optional Bulk Oil Disposal System .....	3-17
	3-15 Changing the Filter Pad .....	3-18
	3-16 Removing and Cleaning Basket Rest .....	3-20
	3-17 Clean-Out Mode .....	3-21
	3-18 Check/Replace Filter Drain Pan O-Rings .....	3-24
	3-19 Info Button Stats .....	3-25
	3-20 Filter Button Stats .....	3-25
	3-21 Preventive Maintenance Schedule .....	3-26
Section 4.	<b>INFORMATION MODE</b> .....	4-1
	4-1 Information Mode Details .....	4-1
Section 5.	<b>PRODUCT PROGRAM MODE</b> .....	5-1
	5-1 Modifying Product Settings .....	5-1

**TABLE OF CONTENTS (Continued)**

<b>Section</b>		<b>Page</b>
Section 6.	LEVEL 2 PROGRAMMING .....	6-1
6-1	Special Program Mode .....	6-1
6-2	Clock Set .....	6-10
6-3	Data Logging, Heat Control, Tech, Stat and Filter Control Modes .....	6-10
Section 7.	TROUBLESHOOTING .....	7-1
7-1	Troubleshooting Guide .....	7-1
7-2	Error Codes .....	7-3

## SECTION 1. INTRODUCTION

### 1-1. INTRODUCTION

The Henny Penny reduced oil capacity open fryer is a basic unit of food processing equipment. This unit is used only in institutional and commercial food service operations.



### **NOTICE**

As of August 16, 2005, the Waste Electrical and Electronic Equipment directive went into effect for the European Union. Our products have been evaluated to the WEEE directive. We have also reviewed our products to determine if they comply with the Restriction of Hazardous Substances directive (RoHS) and have redesigned our products as needed in order to comply. To continue compliance with these directives, this unit must not be disposed as unsorted municipal waste. For proper disposal, please contact your nearest Henny Penny distributor.

### 1-2. PROPER CARE

As in any unit of food service equipment, the Henny Penny open fryer does require care and maintenance. Requirements for the maintenance and cleaning are contained in this manual and must become a regular part of the operation of the unit at all times.

### 1-3. ASSISTANCE

Should you require outside assistance, call your local independent distributor in your area, or call Henny Penny Corp. at 1-800-417-8405 or 1-937-456-8405.

## **1-4. SAFETY**

The Henny Penny open fryer has many safety features incorporated. However, the only way to ensure a safe operation is to fully understand the proper installation, operation, and maintenance procedures. The instructions in this manual have been prepared to aid you in learning the proper procedures. Where information is of particular importance or safety related, the words **DANGER**, **WARNING**, **CAUTION**, and **NOTICE** are used. Their usage is described below.

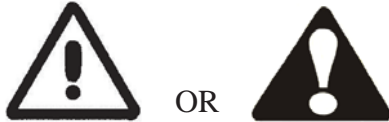

**SAFETY ALERT SYMBOLS** are used with **DANGER**, **WARNING**, or **CAUTION** which indicates a personal injury type hazard.



**NOTICE** is used to highlight especially important information.



***CAUTION** used without the safety alert symbol indicates a potentially hazardous situation which, if not avoided, may result in property damage.*



***CAUTION** used with the safety alert symbol indicates a potentially hazardous situation which, if not avoided, may result in minor or moderate injury.*



**WARNING** indicates a potentially hazardous situation which, if not avoided, could result in death or serious injury.



**DANGER** INDICATES AN IMMINENTLY HAZARDOUS SITUATION WHICH, IF NOT AVOIDED, WILL RESULT IN DEATH OR SERIOUS INJURY.

**1-4. SAFETY**  
**(Continued)**



Equipotential Ground Symbol



Waste Electrical and Electronic Equipment (WEEE) Symbol



OR



Shock Hazard Symbols



OR



Hot Surface Symbols



Pinch-Point Symbol (Auto-Lift Fryers)



## SECTION 2. INSTALLATION

### 2-1. INTRODUCTION

This section provides the installation and unpacking instructions for the Henny Penny open fryer.

### NOTICE

Installation of this unit should be performed only by a qualified service technician.



**Do not puncture the fryer with any objects such as drills or screws as component damage or electrical shock could result.**

### 2-2. UNPACKING INSTRUCTIONS

### NOTICE

Any shipping damage should be noted in the presence of the delivery agent and signed prior to his or her departure.

1. Cut and remove the metal bands from the carton.
2. Remove the carton lid and lift the main carton off the fryer.
3. Remove corner packing supports (4).
4. Cut the stretch film from around the carrier/rack box and remove it from the top of the fryer lid.
5. Cut and remove the metal bands holding the fryer to the pallet.

### CAUTION

*Remove filter drain pan and JIB shelf from fryer before removing fryer from pallet or damage to the unit could result. Figure 1*

6. Remove the fryer from the pallet.



**Take care when moving the fryer to prevent personal injury. The fryer can weigh up to 800 lbs. (363 kg).**

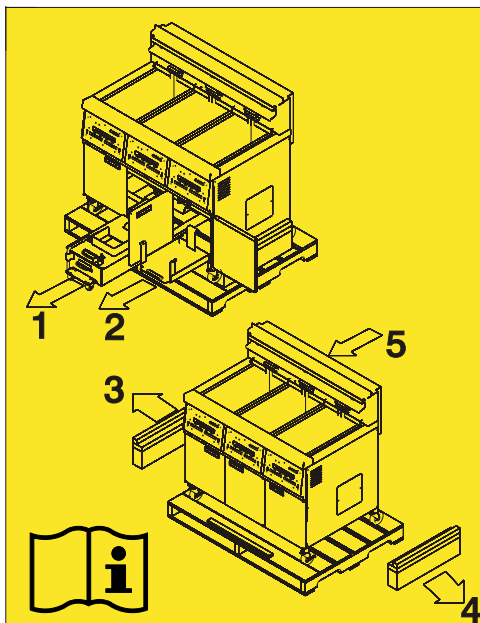

Figure 1

### **2-3. SELECTING THE FRYER LOCATION**

The proper location of the fryer is very important for operation, speed, and convenience. The location of the open fryer should allow clearances for servicing and proper operation. Choose a location which will provide easy loading and unloading without interfering with the final assembly of food orders. Operators have found that frying from raw to finish, and holding the product in warmers provides fast continuous service. Keep in mind, the best efficiency will be obtained by a straight line operation, i.e. raw in one side and finished out the other side. Order assembly can be moved away with only a slight loss of efficiency.



*To avoid fire and ruined supplies, the area under the fryer should not be used to store supplies.*



**To prevent severe burns from splashing hot oil, position and install fryer to prevent tipping or movement. Restraining ties may be used for stabilization.**

### **2-4. LEVELING THE FRYER**

For proper operation, the open fryer should be level from side-to-side and front to back. Using a level placed on the flat areas around the vat collar, on the middle well, and then adjust the casters until the unit is level.

**2-5. VENTILATION OF FRYER**

The fryer should be located with provision for venting into adequate exhaust hood or ventilation system. This is essential to permit efficient removal of steam exhaust and frying odors. Special precaution must be taken in designing an exhaust canopy to avoid interference with the operation of the fryer. We recommend you consult a local ventilation or heating company to help in designing an adequate system.



Ventilation must conform to local, state, and national codes. Consult your local fire department or building authorities.

**2-6. ELECTRICAL REQUIREMENTS**

Check the data plate, mounted on the inside of the doors, to determine the correct power supply.



This fryer must be adequately and safely grounded (earthed) or electrical shock could result. Refer to local electrical codes for correct grounding (earthing) procedures or in absence of local codes, with The National Electrical Code, ANSI/NFPA No. 70-(the current edition). In Canada, all electrical connections are to be made in accordance with CSA C22.1, Canadian Electrical Code Part 1, and/or local codes.

To avoid electrical shock, this appliance must be equipped with an external circuit breaker which will disconnect all ungrounded (unearthed) conductors. The main power switch on this appliance does not disconnect all line conductors.

**(FOR EQUIPMENT WITH CE MARK ONLY!)**

To prevent electric shock hazard this appliance must be bonded to other appliances or touchable metal surfaces in close proximity to this appliance with an equipotential bonding conductor. This appliance is equipped with an equipotential lug for this purpose. The equipotential lug is marked with the following symbol



**2-6. ELECTRICAL  
REQUIREMENTS  
(Continued)**

**CABLE RESTRAINT**

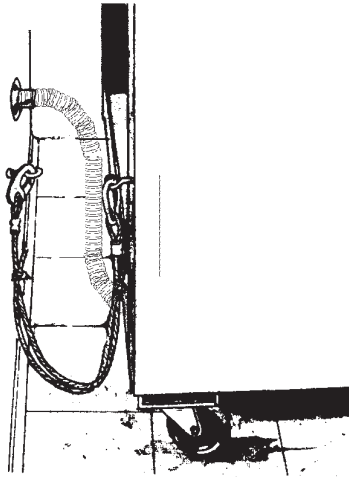

I-bolt is to be secured to the building using acceptable building construction practices.

**CAUTION**

**DRYWALL CONSTRUCTION**  
Secure I-bolt to a building stud. Do not attach to drywall only. Preferred installation is approximately six inches to either side of service. Cable restraint must be at least six inches shorter than flexible conduit.

An all pole, separate disconnect switch, with proper capacity fuses or breakers must be installed at a convenient location between the fryer and the power source, and must be installed according to national and local codes. It should be an insulated copper conductor rated for 600 volts and 90° C. For runs longer than 50 feet (15.24 m), use the next larger wire size. CE units require a minimum wire size of 6 mm to be wired to the terminal block.

It is recommended that a 30 mA rated protective device such as a residual current circuit breaker (RCCB), or ground fault circuit interrupter (GFCI), be used on the fryer circuit.

Permanently connected electric fryers with casters must be installed with flexible conduit and a cable restraint, when installed in the United States. See illustration at left. Holes are available in the rear fryer frame for securing the cable restraint to the fryer. The cable restraint does not prevent the fryer from tipping.

Each vat has it's own power cord assembly, and uses NEMA 15-50 Straight Plug or NEMA 15-60P.

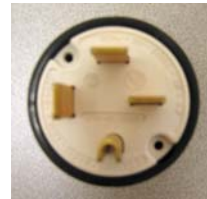

The supply power cords shall be oil-resistant, sheathed flexible cable, no lighter than ordinary polychloroprene or other equivalent synthetic elastomer-sheathed cord.

**2-7. DIMENSIONS**

**NOTICE**

**Auto-Lift Fryers**

Front to rear dimension is 36-7/8 (93.66 cm).

For doorways 36 in. (91.44 cm) or less, the protective bumper bar on rear of the fryer needs removed. See photo at below.

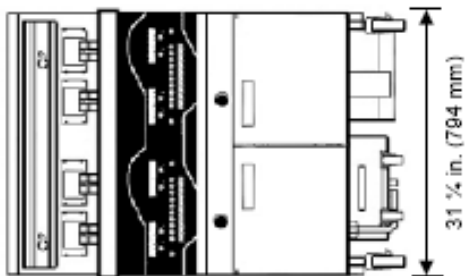
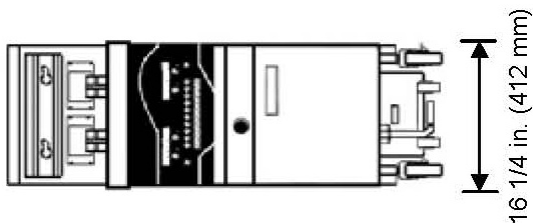
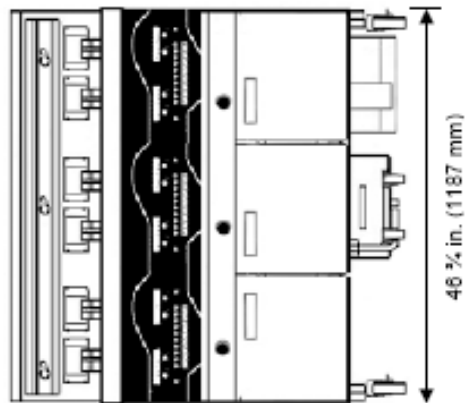
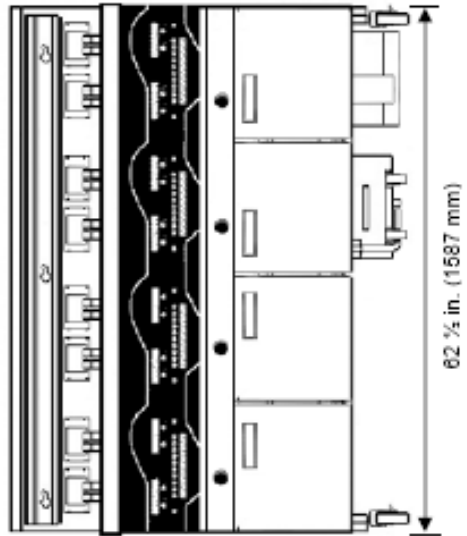
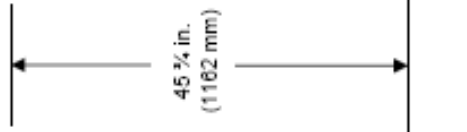
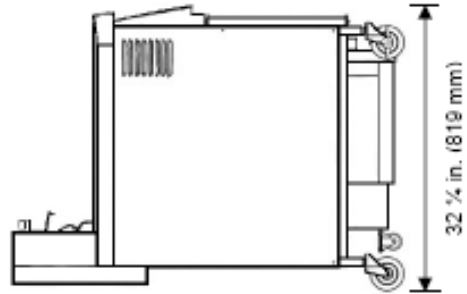
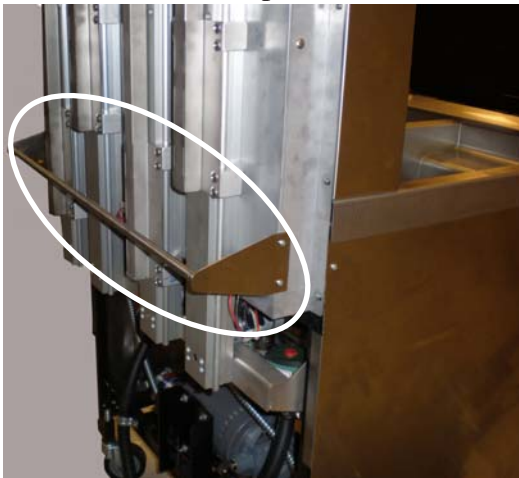

**SECTION 3. OPERATION**

**3-1. OPERATING COMPONENTS** Refer to explanations on the next pages.

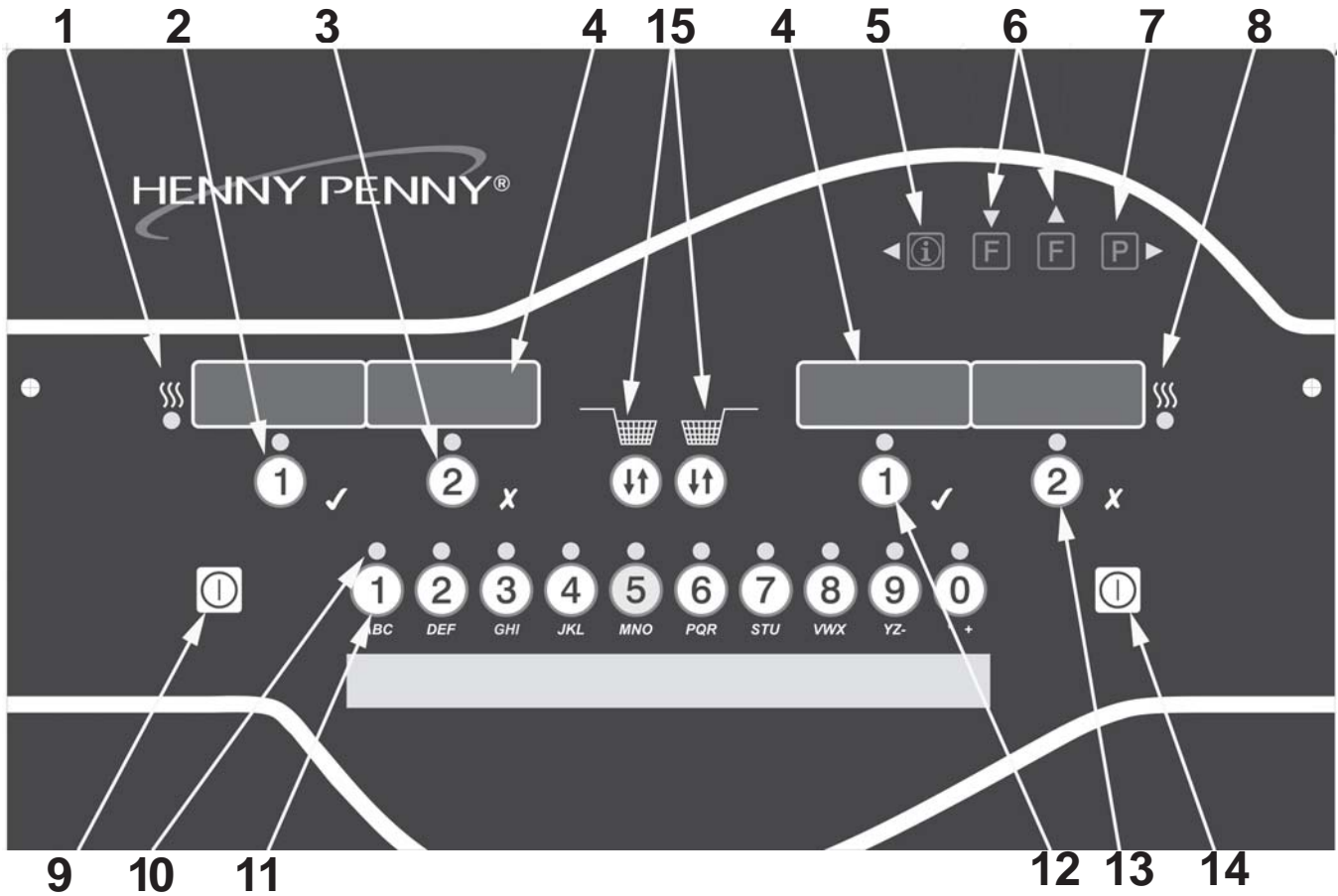

**Figure 3-1**

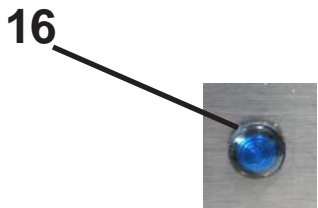

**Figure 3-2**

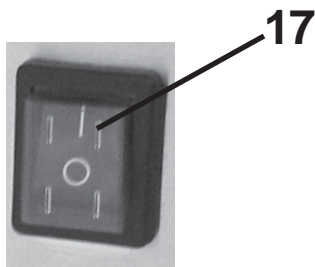



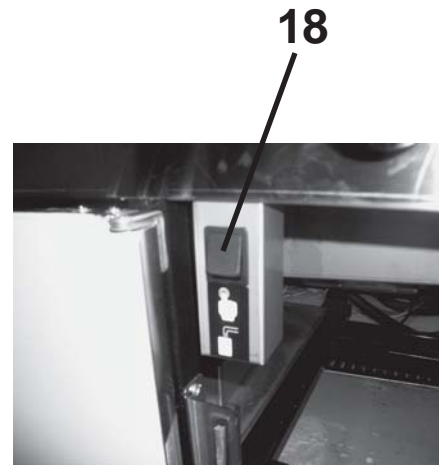









**Figure 3-3**













**Figure 3-4**  
**(Bulk Oil Supply Fryers Only)**

**3-1. OPERATING COMPONENTS**  
**(Continued)**

Refer to Figures 3-1, 3-2 & 3-3 in conjunction with the description of the functions below.

<b>Fig. No.</b>	<b>Item No.</b>	<b>Description</b>	<b>Function</b>
3-1	1		This LED lights when the control calls for heat for the left vat(s), and the elements come on and heat the oil
3-1	2		During normal operation, press this button to start and stop cook cycles for the left basket; press to change displayed product; also used for ✓ to indicate YES or to confirm
3-1	3		During normal operation, press this button to start and stop cook cycles for the left basket; press to change displayed product; also used for X to indicate NO or cancel
3-1	4	Digital Display	Shows the product codes; shows the timer countdown during cook cycles; shows the prompts during the filter modes; shows the selections in the Program Mode; shows the temperature of the oil by pressing  ; shows error codes (also displays in several languages)
3-1	5		Press once to view oil temperature; press twice to view the setpoint temperature; Used in the Programming Modes; also used for  button; press to display the following fryer information status: <ul style="list-style-type: none"> <li>a. actual oil temperature</li> <li>b. oil setpoint temperature</li> <li>c. recovery information for each vat</li> </ul>
3-1	6		Used in the Programming and Filtering Modes; left button used for left split vat and right button used for  or  buttons; press to view the following filtering stats: <ul style="list-style-type: none"> <li>a. number of cook cycles before next filter-Global Filter Mode or percentage of filter allowance-Mixed Mode</li> <li>b. time and date of the most recent filter on each vat</li> </ul>
3-1	7		Used to access the Program Modes; used as  button to advance to the next parameters in Program and Filter Modes; press to select 2nd languages and volumes
3-1	8		This LED lights when the control calls for heat for the right vat(s), and the elements come on and heat the oil
3-1	9		Press to turn on and off the heat system for the left vat(s)

**3-1. OPERATING COMPONENTS (Continued)**

<b>Fig. No.</b>	<b>Item No.</b>	<b>Description</b>	<b>Function</b>
3-1	10 & 11		<p>Each product button LED lights when that particular product has been selected, or when it is compatible with cook temperature</p> <p>Press to select the desired product; press to place the letters under the button, during naming a product in Program Mode</p> <p>The  can be used to start an Idle Mode if enabled in Special Program Mode</p>
3-1	12		<p>During normal operation, press this button to start and stop cook cycles for the right basket; press to change displayed product; press to confirm prompts in the filter modes; also used for ✓ to indicate YES or confirmation</p>
3-1	13		<p>During normal operation, press this button to start and stop cook cycles for the right basket; press to change displayed product; press to deny prompts in the filter modes; also used for X to indicate NO or cancel</p>
3-1	14		<p>Press to turn on and off the heat system for the right vat(s)</p>
3-1	15		<p>Auto-lift equipped fryers ONLY. Press to raise or lower baskets.</p>
3-2	16		<p>A Filter Beacon® is found beside each black drain knob; when lit blue  indicates the oil should be filtered at this time; beacon flashes when the drain needs opened or closed</p>
3-3	17		<p>When the power switch is turned to the ON position, power is supplied to the controls and pumps</p>
3-4	18		<p>For fryers with a bulk oil supply, press this button to fill the JIB</p>



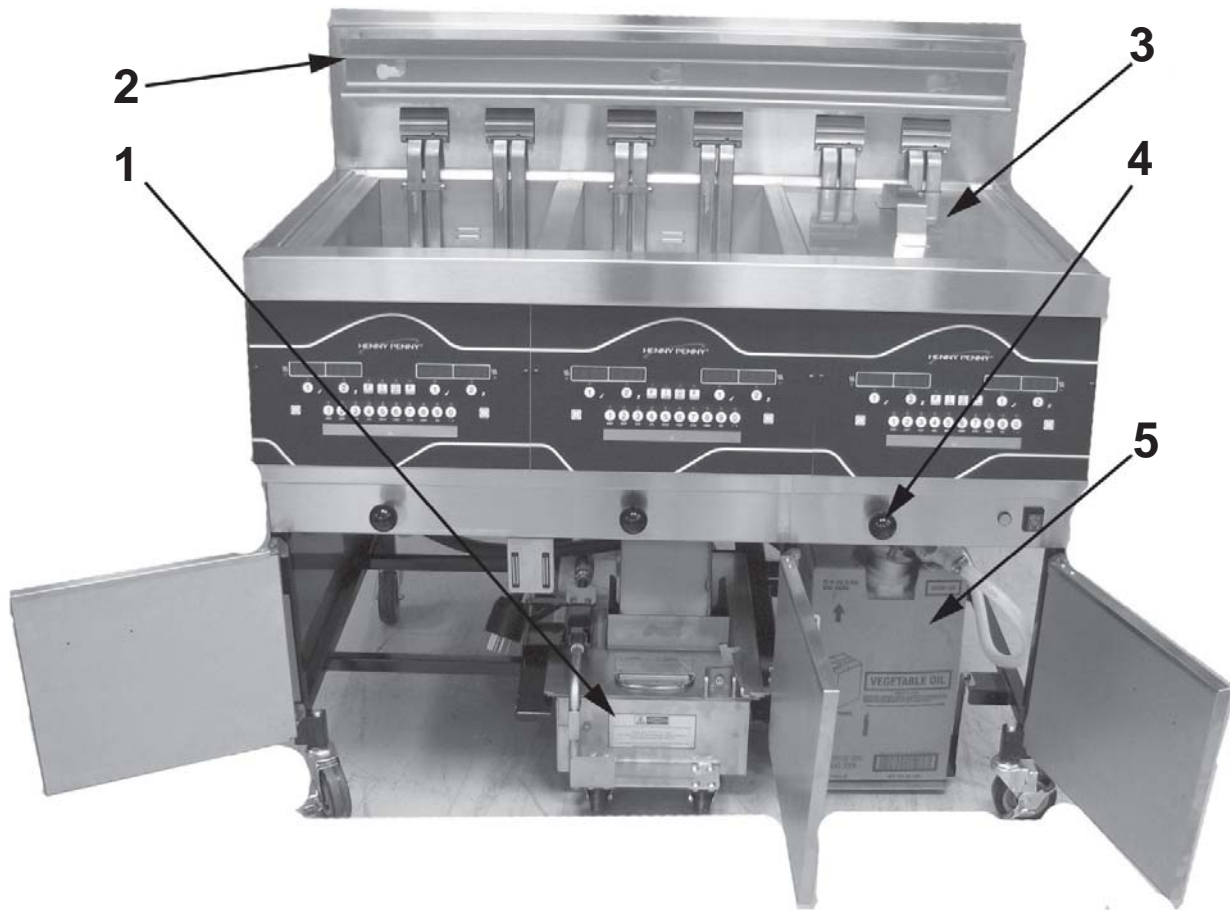



**Figure 3-5**

<b>Fig. No.</b>	<b>Item No.</b>	<b>Description</b>	<b>Function</b>
3-5	1	Filter Drain Pan Assy.	Oil is drained into this pan and then is pumped through filters to help prolong the use of the oil
3-5	2	Basket Rest	The baskets hang on this when not in use, or to drain the product after a cook cycle
3-5	3	Vat Covers	Covers the vat when not in use
3-5	4	Drain Knob	Pull-out on black knobs to open drain valve and oil drains from vat; Push-in to close drain valve and oil can be pumped into vat
3-5	5	JIB	Jug-in-a-Box; holds oil to be pumped into vats to top-off the oil level by the Oil Guardian™ process





### 3-2. SET-UP MODE

Upon initial start-up, the controls will ask to confirm the settings for the fryer.

When the main power switch is turned on, “OFF” shows in both displays. Press  on either side and \*SETUP\* \*ENTER CODE\* shows in the displays. Press 1, 2, 3, and “LANGUAGE” shows on the left display, “ENGLISH” on the right display.

Use  or  buttons to change the operation display to, “FRANCAIS”, “ESPANOL”, “PORTUG”, “DEUTSCHE”, “SVENSKI”, “RUSSIAN”.

Press  to continue with the other set-up items which include:

- TEMP FORMAT - °F or °C
- TIME FORMAT - 12-HR OR 24-HR
- ENTER TIME - Time of day (use product buttons to change)
- ENTER TIME - AM OR PM
- DATE FORMAT - US (MM-DD-YY) or INTERNATIONAL (DD-MM-YY)
- ENTER DATE - Today’s date (use product buttons to change)
- DAYLIGHT SAVING TIME - 1.OFF; 2.US (2007 & after); 3.EURO; 4.FSA (US before 2007)
- FRYER TYPE - ELEC or GAS
- VAT TYPE - FULL OR SPLIT
- AUTOLIFT ENABLED? - NO LIFT or YES LIFT
- BULK OIL SUPPLY - YES or NO
- BULK OIL DISPOSE? - YES or NO
- S/N - Shows serial number of the unit or can be recorded (THIS SERIAL NUMBER SHOULD MATCH THE SERIAL NUMBER ON THE DATA PLATE, ON THE DOORS.)
- 2nd LANGUAGE - By setting a second language in the controls, 2 languages can now be easily chosen by pressing  during normal operation.  
One language shows in the left display and the second language shows in the right display. Pressing the  button under the desired language, selects that language seen in displays.
- 2nd VOLUME - By setting a second volume in the controls, 2 volumes can now be easily chosen by pressing  twice during normal operation.  
One volume setting shows in the left display (NONE to 10; 10 being the loudest) and the second volume shows in the right display. To select the volume, press the  button under the desired volume .
- SETUP COMPLETE

**NOTICE**

Unless otherwise indicated, use  or  to change settings.

The Setup Mode can also be accessed by re-initializing the controls, in Special Program Mode, in Level 2 programming (SP-3).

### 3-3. FILLING OR ADDING OIL

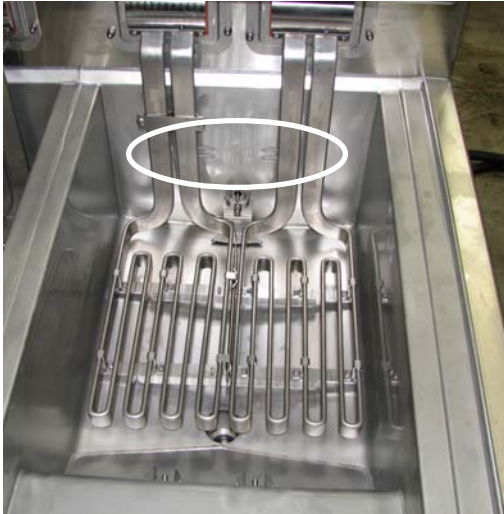

Figure 1



Figure 2



Figure 3

## CAUTION

The oil level must always be above the heating elements when the fryer is heating and at the oil level indicators on the rear of the vat. Failure to follow these instructions could result in a fire and/or damage to the fryer.

Solid oil is not recommended. Solid oil could cause clogging and pump failures.

1. It is recommended that a high quality liquid frying oil be used in the open fryer. Some low grade oils have a high moisture content which causes foaming and boiling over.

## WARNING BURN RISK

Wear gloves to avoid severe burns when pouring hot oil into vat. Oil and all metal parts that are in contact with the oil are extremely hot; take care to avoid splashing.

2. **Oil Capacities:**

Full-size vats = 15 quarts/30 lbs (14.2 liters/13.6 kg)

Split-vats = 7.5 quarts/15 lbs (7.1 liters/6.8 kg).

All vats have 2 level indicator lines inscribed on the rear wall of the vat, in which, the upper-most line shows the oil at the proper level when heated. Figures 1 & 2.

3. Place basket support inside of vat and fill vat with cold oil to the lower indicator. Figure 3.

### Filling Vat from Bulk Supply (Must be equipped with optional accessories & controls set to “YES” for “Bulk Oil Supply?” in Set-Up Mode)

1. Turn the main power switch to the ON position.
2. Place basket support inside of vat. Figure 3.
3. Press and hold **F** (on either side) until display shows \*FILTER MENU\*, along with 1.AUTO FILTER?
4. Press and release **▶** button 6 times until display shows “7. FILL POT FROM BULK”.
5. Press **√** button and display shows “FILL VAT” and then “√=PUMP” “X=DONE”. Press and hold **√** button again to fill vat and display shows “FILLING”.
6. Once oil is to the lower fill line, release **√** button and display returns to “FILL VAT” “√=PUMP” “X=DONE”. Press **X** button twice to return to normal operation.



## NOTICE

Press and hold the black button behind the right door to fill the JIB from the Bulk Supply as needed. Figure 3.

### **3-4. MORNING START-UP PROCEDURES**

1. Make sure basket support is in vat and the vat is filled with oil to the proper level.

Model EEE-141, fill the oil reservoir. See Section 3-10.

2. Move power switch to the ON position and then press  to turn on heat for the desired vat. If display shows “IS POT FILLED?” make sure oil is at the proper level (see Section 3-3) and then press  button for “YES”.

Unit automatically goes into the Melt Cycle until the oil temperature reaches 180°F (82°C) and then control automatically exits the Melt Cycle.

#### **NOTICE**

The Melt Cycle may be bypassed, if desired, by pressing  button or  button and holding it for 5 seconds.

The control then shows “EXIT MELT” “YES NO”. Press  button for “YES” and vat heats continuously until the set-point temperature is reached.

#### **CAUTION**



*Do not bypass the Melt Cycle unless enough oil has melted to completely cover all of the elements. If the Melt Cycle is bypassed before all elements are covered, excessive smoking of oil, or a fire will result.*



**DO NOT OVERLOAD, OR PLACE PRODUCT WITH EXTREME MOISTURE CONTENT INTO THE BASKETS. 3 LBS. (1.4 KG.) IS THE MAXIMUM AMOUNT OF PRODUCT PER FULL VAT AND 1-1/2 LBS. (.68 KG.) FOR THE SPLIT VATS. FAILURE TO FOLLOW THESE INSTRUCTIONS CAN RESULT IN OIL OVERFLOWING THE VAT WHICH COULD CAUSE SERIOUS BURNS, PERSONAL INJURY, FIRE AND/OR PROPERTY DAMAGE.**



### **3-5. BASIC OPERATION**

The Evolution Elite fryer is available as non-auto-lift and auto-lift models. The auto-lift controls, allow the baskets to be automatically lowered into the shortening at the beginning of the cook cycle, and raised from the shortening at the end of the cycle.

1. Once out of the Melt Cycle, LOW TEMP flashes until the set-point temperature has been reached. No cook cycles can be started while “LOW TEMP” shows in the display. Once the set-point temperature has been reached, the product name now shows in the display, ex: FRY, and product now can be placed in the oil.
2. Press a timer button  or . (Auto-lift fryers, the basket automatically lowers into the shortening.)
3. Display shows the name of the product cooking (ex: “FRY”) and the timer counting down.
4. When cook cycle is complete, and alarm sounds and display shows “DONE”.
5. Press the timer button under “DONE” to stop the alarm, and lift basket from vat. (Auto-lift fryers, the basket automatically rises out of the shortening.)
6. If a Quality Timer (hold timer) has been programmed, the hold time starts automatically when the user presses the timer button to end the cook cycle. While the quality timer counts down, the display shows the three-digit product abbreviation followed by “Qn”, where “n” is the number of minutes remaining. ex: “FRY” / “Q5” / “FRY” / “Q5” / “FRY” / “Q4”, etc.

At the end of the timer countdown, the control beeps and the display shows “QUAL” followed by the three-digit product name: “QUAL” / “FRY” / “QUAL” / “FRY”. Press the timer button to cancel the timer.

## NOTICE

To stop a cook cycle at any time, press and hold the timer button  or .

### **3-6. IDLE MODE**

Once programmed, an Idle Mode can help to save on oil and utility costs. If the fryer is not being used for several minutes, the controls can be set to automatically lower the oil temperature, or press the  button to start the Idle Mode.

The oil is maintained at a lower temperature until the  button is pressed, and then the oil is heated to cooking temperature. See Special Program Modes, SP-12, SP-13 & SP-14.

### **3-7. OIL GUARDIAN™** **(Auto Top-Off)**

During normal operation, the control automatically monitors the oil level in the vat. If the control senses the oil level too low, the unit automatically pumps oil from the JIB into the vat to keep the oil at the proper level.

#### **Manual Top-Off**



If the oil level is a little low, oil can be added to the vat at any time from the JIB to raise the oil level to the proper level by following the steps below. This procedure is NOT to be used to fill an empty vat

1. Press and hold **F** until display shows “\*FILTER MENU\*”, along with “1.EXPRESS FILTER”.
2. Press **▶** 5 times until “6.FILL FROM JIB” shows in the display.
3. Press **√** button and display shows “\*PUMP” and “EXIT”.
4. Press and hold **√** button and display shows “FILLING” and the oil is pumped from the JIB to the vat.
5. Once frypot is full, release **√** button and display returns to “\*PUMP” and “EXIT”. Press **X** button twice to return to normal operation.

### **3-8. SELECTING A PRODUCT WITH A DIFFERENT SETPOINT**

When selecting a product, if “XXX XXX” shows in the display, the setpoint temperature is not correct for this product.

To change the setpoint temperature for the desired product:

1. Press product button, for ex:  (FRY).
2. Display shows “XXX XXX”.
3. Press and hold a timer button  or  for 5 seconds and then “FRY” shows in display.
4. Allow oil temperature to reach setpoint temperature before dropping product.

### **3-9. REPLACING THE JIB**



**Figure 1**

1. Control displays “JIB IS LOW” and an alarm sounds.
2. Open right door and pull JIB from unit. Pull the cap from top of JIB and discard empty JIB and replace with full one.

Figure 1

**NOTICE**

Model **EEE-141** (single-well) see next section.

### 3-10. MODEL EEE-141 OIL RESERVOIR



**Figure 1**



**Figure 2**



**Figure 3**



**Figure 4**

### **Filling Oil Reservoir**

1. Control displays “JIB IS LOW” and an alarm sounds.
2. Open door and pull reservoir forward and remove reservoir cover. Figure 1.
3. Place on bracket on door. Figure 2.
4. Pour oil into reservoir upto the fill lines (13 lbs. (6.12 kg.)) and then replace cover and push reservoir back into position. Figure 3.

### **Removing/Cleaning Reservoir**

1. Open door and pull reservoir forward.
2. Slide reservoir to the left and lift from fryer. Figure 4.
3. Clean reservoir at a sink with soap and water.

## **NOTICE**

Before placing the reservoir back into position, lubricate the o-rings (below) on the filter tube with cold oil. Check o-rings for tears or nicks and replace if necessary.

To replace o-ring, use a small, flat-bladed screwdriver, pry up on the o-ring and pull off of end of tube. See below.



**3-11. SMARTFILTER EXPRESS™**



**Figure 1**



**Figure 2**



**Figure 3**

1. During normal operation and after a certain number of cook cycles, the Filter Beacon® illuminates on the front of the fryer (Figure 1), and the control periodically shows “FLTR NOW?” “YES NO”.

If **X** for NO is pressed, fryer resumes normal operation and control suggests filter later.

2. **Check Filter Pan:** If the filter drain pan or cover is not in place, the display shows “CHK PAN”. Make sure that the filter pipe is tightly connected, and that the filter drain pan is as far back under fryer as it will go and the filter pan cover is in place.
3. Press  $\checkmark$  button for YES and display shows \*SKIM VAT\* followed by “CONFIRM” “YES NO”. Press  $\checkmark$  button for YES and display shows “OPEN DRAIN”. Pull-out on the drain knob (Figure 2), the display shows “DRAINING” and the oil drains from the vat.



**To avoid overfilling the drain pan, drain only 1 vat at a time. The drain pan holds 1 full vat, or 2 split vats of oil. Overfilling the drain pan may cause slippery floors, which may result in personal injury.**



If filtering is NOT desired, press  $\text{⏏}$ , the display shows “STOPPED” and the SmartFilter is cancelled. The blue light goes out and the controls return to normal operation. The controls will suggest filtering after several more cook cycles.

If display shows “VAT EMTY”, followed by, “YES NO”, that means the drain is clogged. Use the straight white brush to clear drain and then press  $\checkmark$  button. Display shows “DRAINING”, and then controls proceed with the filtering process.

4. Once the control has completed the filtering process, display shows “CLOSE DRAIN”. Push-in on the drain knob to close the drain (Figure 3). The vat then re-fills with oil.
5. Once vat is filled, display shows “IS POT FILLED?” “YES NO”. Make sure vat is full and then press  $\checkmark$  button for YES and the control returns to normal operation.



**3-11. SMARTFILTER EXPRESS™**  
**(Continued)**

7. If the oil has not pumped back to the proper level in the vat during the SmartFilter Express™ process, press **X** button for NO and pump runs for another 30 seconds.
9. Display shows “IS POT FILLED?” “YES NO”. Make sure vat is full and then press **√** button and display shows and the control returns to normal operation. Press **X** button and pump runs for another 30 seconds. You can try to fill the vat 3 times.

**Filter Error**

10. After trying to fill the vat 3 times without success, the controls then shows “CHANGE FILTER PAD?” “YES NO”. If changing the filter pad at this time, press **√** and change filter pad following the procedures in the Changing the Filter Pad Section. Controls return to normal operation.

If filter pad is to be changed at a later time, press **X** button and “CHANGE FILTER PAD?” reminder shows 15 minutes later.

11. During the next SmartFilter Express™ with a new filter pad, if the vat is not filled after 3 tries, the display shows “FILTER SERVICE REQUIRED-SEE TROUBLESHOOTING GUIDE”.

If the “Service Required” message appears, then every 15 minutes the display shows “FILTER PROBLEM FIXED? YES NO”. If the problem has not been fixed, press **X** button. Once the problem has been resolved, press **√** and controls return to normal operation.

**NOTICE**

To help ensure the vat fills completely, make sure filter pan is cleaned at least daily, filter pad is changed, make sure JIB is full and that “O” rings on the filter pan are in good condition.

### **3-12. DAILY FILTERING**

This filtering procedure allows for a more thorough cleaning of the vat and should be done once a day. The vat can be filtered during any non-frying times.



**To avoid burns from hot oil, use approved safety equipment including, apron, face shield and gloves before starting filtering procedure.**

**Also, to avoid overfilling the drain pan, drain only 1 vat at a time. The drain pan holds 1 full vat, or 2 split vats of oil. Overfilling the drain pan may cause slippery floors, which may result in personal injury.**



**Figure 1**

1. **Check Filter Pan:** A new filter pad should be used on the first filter of each day, but the same filter pad can be used the rest of the day, except for fish vats. **After filtering a fish vat, it is recommended to change the filter pad.**

Make sure that the filter pan cover is in place, the filter drain tube is secured, and the filter drain pan is pushed in and locked into place. If the filter drain pan and cover are not latched into place, the display shows “CHK PAN”.

2. Press and hold **F** until display shows “1.EXPRESS FILTER?” Split vat units, use the left **F** button for the left vat and the right **F** button for the right vat.
3. Press **▶** button and display shows “2.DAILY FILTER?”
4. Press **√** button for YES and display shows “CONFIRM”, followed by “YES NO”.
5. Press **√** button for YES and display shows “OPEN DRAIN” Pull-out on the drain knob (Figure 1), the display shows “DRAINING” and the oil drains from the vat, **or** press **X** button for NO and controls return to normal operation.

**3-12. DAILY FILTERING**  
**(Continued)**



**Figure 2**

6. Once oil has drained from vat, use the lift tool and lift the hinged element from the vat to clean the bottom of the vat. Figure 2. (Auto-lift fryers, hinge back the basket hooks over the top of the fryer before lifting the elements.)



**Use protective cloth or gloves when lifting the element with the lift tool. The element may be hot and severe burns could result.**



*Avoid putting the lift tool in the center of the elements, at the same area as the high limit bulb, or damage to the high limit could result.*

7. Scrape or brush the sides and the bottom of the vat. Be careful not to damage the sensing probes.



*Do not use steel wool, other abrasive cleaners or cleaners/sanitizers containing chlorine, bromine, iodine or ammonia chemicals, as these will deteriorate the stainless steel material and shorten the life of the unit.*

*Do not use a water jet (pressure sprayer) to clean the unit, or component damage could result.*



**Figure 3**

8. Once the vat is clean and the display shows “SCRUB VAT COMPLETE?” “YES NO”. Press  $\checkmark$  button for YES and the display shows “WASH VAT” “YES NO”..

9. Lower the element and then press  $\checkmark$  button and display shows “WASHING”. The oil circulates through the vat for several minutes. Once the wash cycle is complete, display shows “WASH AGAIN?” “YES NO”.

10. Press  $\checkmark$  button for YES if another wash is needed, otherwise press **X** button for NO and the display shows “CLOSE DRAIN” Push-in on the drain knob to close the drain (Figure 3) and the display shows “RINSING” and vat fills with oil.



**Figure 4**

11. Once the vat is filled, “OPEN DRAIN” shows in display. Pull-out on drain knob to open the drain (Figure 4) and display shows “RINSING”. When rinsing is complete, display shows “RINSE AGAIN?” “YES NO”.

**3-12. DAILY FILTERING**  
**(Continued)**

12. Press **√** button for YES if another rinse is needed, otherwise press **X** button for NO. The display shows “POLISH?” “YES”.
  
13. Press **√** button for YES and the oil is “polished” by circulating it through the filtering system. The display shows “5:00 STOP POLISH”. If desired, press **√** button to stop the polishing, otherwise the oil is polished for 5 minutes.
  
14. Once the oil is polished, the display shows “FILL VAT?” “YES”. Press **√** button and display shows “CLOSE DRAIN”. Push-in on the drain knob to close the drain (Figure 3), the display shows “FILLING” and the vat then re-fills with oil.
  
15. Once full, the display shows “IS POT FILLED?” “YES NO”. Press **√** button for YES and fryer returns to normal operation.

If **X** button is pressed, the display shows “FILLING”. You can try to fill the vat 4 times and then the control shows “ADD QUIT”. Press **√** button and JIB pump runs 60 seconds, filling the vat from the JIB. Press **X** button and controls return to normal operation.

**3-13. DISCARDING OIL FROM VAT USING OPTIONAL OIL DISCARD SHUTTLE**



**Figure 1**



**Figure 2**



**Figure 3**



**WITH PROLONGED USE, THE FLASHPOINT OF OIL IS REDUCED. DISCARD OIL IF IT SHOWS SIGNS OF EXCESSIVE SMOKING OR FOAMING. SERIOUS BURNS, PERSONAL INJURY, FIRE, AND/OR PROPERTY DAMAGE COULD RESULT.**

1. Open the door, lift-up on the drain pan stop and pull-out the drain pan assembly, using the handle on the drain pan. Figures 1 & 2.

2. Press and hold **F** (either one) until display shows “\*FILTER MENU\*”, along with “1.EXPRESS FILTER?”.

3. Press and release **▶** button twice until display shows “3.DISPOSE”. Press **√** button and display shows “DISPOSE?” “YES NO”.

4. Press **√** button and “IS DISPOSAL UNIT IN PLACE?” “YES NO” shows in display.

If Bulk Oil Dispose is set to “YES”, “DRAIN VAT?” YES NO” shows in display

5. With discard shuttle rolled into place (Figure 3), press **√** button and display shows “OPEN DRAIN”. Pull-out on drain knob to open drain and display shows “DRAINING”. Oil now drains from the vat into the shuttle.

6. Display shows “VAT EMTY “YES NO”. Verify that vat is empty, and press **√** button.

7. Display shows “CLN VAT COMPLETE” “YES NO”. Once vat is clean, press **√** button. and display shows “CLOSE DRAIN”. Push-in on the drain knob.

If Bulk Oil Dispose is set to “YES”, “**√**=PUMP” “**X**=DONE” shows in the display. Press **X** button.

8. Display shows “MANUAL FILL POT”, followed by “IS POT FILLED?”, along with “YES NO”. Fill the vat to the lower indicator line on the rear of the vat and then press **√** button. See Filling or Adding Oil instructions from Section 3-3.

Fryer returns to normal operation.

9. Remove the discard shuttle from under fryer and replace with the filter pan assembly.

### **3-14. OPERATING INSTRUCTIONS FOR OPTIONAL BULK OIL DISPOSAL SYSTEM**

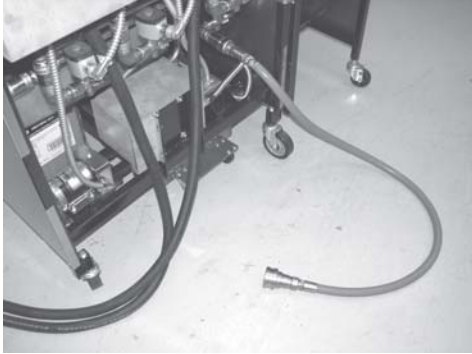

**Figure 1**



**Figure 2**

1. Connect the female quick disconnect, that is attached to the hose in the rear of the open fryer, to the correct male quick disconnect at the wall. Once attached, the hose can remain connected unless the open fryer is moved. Figures 1 & 2.

## **NOTICE**

“BULK OIL DISPOSE?” in the Special Program Mode or Set-Up Mode, must be set to “YES” for the Bulk Oil Dispose System to operate. Also, a password code step (1, 2, 3) can be added in Special Programming, SP-27.

2. Press and hold **F** (left or right for split vats) until display shows “\*FILTER MENU\*”, along with “1.EXPRESS FILTER?”.
3. Press and release **▶** button twice until display shows “3.DISPOSE”. Press **√** button and display shows “DISPOSE?” “YES NO”, or enter code 1, 2, 3, if SP-27 is set to YES.
4. Press **√** button and “DRAIN VAT?” YES NO” shows in display  
Press **X** button if drain pan already has oil in it. Skip to step 8.
5. Press **√** button and display shows “OPEN DRAIN”. Pull-out on drain knob to open drain and display shows “DRAINING”. Oil now drains from the vat into drain pan.
6. Display shows “VAT EMTY “YES NO”. Verify that vat is empty, and press **√** button.
7. Display shows “CLN VAT COMPLETE” “YES NO”. Once vat is clean, press **√** button.
8. Display shows “DISPOSE” and then “√=PUMP” “X=DONE. Press **√** button and oil is pumped from the drain pan to the bulk oil container.
9. When all the oil is pumped from the pan, press **X** button(STOP)
10. Display shows “DISPOSE” and then “√=PUMP” “X=DONE. Press **X** button and close drain.
11. Display shows “MANUAL FILL VAT” (or “FILL VAT FROM BULK if equipped), followed by “IS POT FILLED?”, along with “YES NO”. Fill the vat to the lower indicator line on the rear of the vat and then press **√** button. See Filling or Adding Oil instructions from Section 3-3.

Fryer returns to normal operation.

### **3-15. CHANGING THE FILTER PAD**



**Figure 1**



**Figure 2**



**Figure 3**



**Figure 4**

In order to assure good oil pumping performance, the filter pad (or paper) should be changed at least once per day.

## **NOTICE**

If the filter pad has not been changed, a reminder shows on the display, “CHANGE PAD”. Press  $\checkmark$  button to cancel the message, but it reappears every 4 minutes until the filter pad has been changed.

1. Make sure the main power switch is in the ON position.
2. Open the door, lift-up on the drain pan stop and pull-out the drain pan assembly, using the handle on the drain pan.  
Figures 1 & 2.



**This pan could be hot! Use protective cloth or glove, or severe burns could result.**

**If the filter pan is moved while full of oil, use care to prevent splashing, or severe burns could result.**

3. Lift the pan cover from the drain pan. Figure 3.

4. Lift the crumb basket from the drain pan. Wipe the oil and crumbs from the crumb basket. Clean the crumb basket with soap and water, then thoroughly rinse with hot water and dry.  
Figure 4.

### **3-15. CHANGING THE FILTER PAD (Continued)**



**Figure 5**

5. Remove the filter pad retaining ring and clean thoroughly with soap and water. Rinse thoroughly with hot water and dry. Figure 5.



**Figure 6**

6. Pull the filter pad from the pan and discard pad. Figure 6.



**Figure 7**

7. Remove the bottom screen from pan and clean thoroughly with soap and water. Rinse thoroughly with hot water and allow to air dry. Figure 7.



**Figure 8**

8. Wipe the oil and crumbs from the drain pan. Clean the drain pan with soap and water, then thoroughly rinse with hot water and dry. Figure 8.



**3-15. CHANGING THE FILTER PAD (Continued)**



**Figure 9**



**Figure 10**

**3-16. REMOVING AND CLEANING BASKET REST**



**NOTICE**

Be sure that the drain pan, bottom screen, crumb catcher, and the retaining ring are thoroughly dry before placing filter pad into pan as water will dissolve the filter pad.

9. Reassemble in reverse order, placing the bottom screen into the filter pan first, followed by the filter pad, retaining ring and the crumb catcher.

**NOTICE**

Before pushing the filter drain pan back into position, lubricate the o-rings (Figure 9) on the filter tube with cold oil. Check o-rings for tears or nicks and replace if necessary. See Section 3-16.

10. Push the filter pan assembly back underneath the fryer, making sure the filter tube on the pan makes a good connection with the fitting underneath the fryer. Figure 9.

11. Make sure the drain pan stop is engaged and the fryer is now ready for normal operation. Figure 10.

The basket rest, on the rear shroud of the fryer, should be removed and cleaned periodically.

**WARNING**  
**BURN RISK**

Use protective gloves when removing the basket rest. The basket rest may be hot and burns could result.

Grasp the basket rest with 2 hands and pull it off the “key-ways”.

Take it to a sink and clean it with soap and water. Dry thoroughly.

Clean the area behind the basket rest and then reinstall the basket rest.

**3-17. CLEAN-OUT MODE**



The filter drain pan must be as far back under fryer as it will go, and the cover in place. Be sure the filter drain pan is latched into place and the hole in the cover lines up with the drain before opening the drain. Failure to follow these instructions causes splashing of shortening and could result in personal injury.

Moving the fryer or filter drain pan while containing hot shortening is not recommended. Hot shortening can splash out and severe burns could result.



Always wear chemical splash goggles or face shield and protective rubber gloves when cleaning the frypot as the cleaning solution is high in alkaline. Avoid splashing or other contact of the solution with your eyes or skins. Severe burns may result. Carefully read the instructions on the cleaner. If the solution comes in contact with your eyes rinse thoroughly with cool water and see a physician immediately.

Also, to avoid overfilling the drain pan, drain only 1 vat at a time. The drain pan holds 1 full vat, or 2 split vats of oil. Overfilling the drain pan may cause slippery floors which may result in personal injury.

1. Cover adjoining vats to avoid accidentally contaminating oil with fryer cleaning solution.



Do not cook product in an adjoining vat when the cleaning process is in progress to avoid contaminating the oil and product.

2. Press and hold **F** until display shows "1.EXPRESS FILTER?". Split vat units, use the left **F** button for the left vat and the right **F** button for the right vat.
3. Press and release **▶** button 6 times and display shows "7.CLEAN-OUT".
4. Press **√** button and display shows "OIL RMVD" "YES NO"
5. If oil has already been removed, press **√** button and control skips down to "Solution Added?" step.

**3-17. CLEAN-OUT MODE**  
**(Continued)**

If vat still has oil, press **X** button and display shows “DISPOSE” “YES NO”. Press **√** button to dispose of the oil, or press **X** button to exit Clean-Out Mode.

Display shows “IS DISPOSAL UNIT IN PLACE?” “YES NO”. If “NO” is selected, display shows “INSERT DISPOSAL UNIT”. Once disposal unit is in place press **√** button for YES, open drain, and display shows “DRAINING” and oil drains from vat. Display then shows “VAT EMTY”, “YES NO”. Press **√** button when ready and close drain.

**Bulk Oil Systems Only!** Display shows “CHK PAN” if the filter drain pan is missing. Once pan is in place, display shows “OPEN DRAIN”. Pull-out drain knob and display shows “DRAINING” and oil drains from vat. Display then shows “**√**=PUMP” “**X**=DONE. Press **√** button, display shows “DISPOSING” and oil is pumped from drain pan. Once pan is empty, press **X** button twice and close drain.

6. Display shows “SOLUTION ADDED?” “YES NO”. Fill the vat to 1 in. (25 mm) above the top fill line with hot water and add 4 ozs. (0.12 liters) of open fryer cleaner and mix thoroughly. Then press **√** button and display shows “START CLEAN” “YES NO”
7. Press **√** button and display shows “CLEANING” and a count-down timer. Heat regulates to 195°F (91°C) for this step for one hour.

Add water as needed during cleaning process to keep solution 1 in. (25 mm) above the top fill line.

To stop the cleaning cycle early, press **X** button. The display shows “QUIT DEEP CLN” “YES NO”. Press the **√** button to cancel the rest of the countdown time and proceed to the rinse steps.

8. Using the open fryer brush (never use steel wool), scrub the inside of the vat. At the end of the one hour, display shows “CLEAN DONE” and beeps. Press **√** button and display then shows “REMOVE SOLUTION FROM VAT”.
9. Empty filter drain pan of internal filtering components and take the components to a sink to be cleaned. Return the empty filter drain pan and cover to the fryer, making sure it is pushed into placed and the latch engaged.
10. Drain cleaning solution into the filter drain pan and pull drain pan from unit and dispose of the solution.

**3-17. CLEAN-OUT MODE**  
**(Continued)**



**To avoid burns when pouring hot solution, wear gloves and protective gear and take care to avoid splashing.**

11. Return empty filter drain pan to fryer and press √ button. Display then shows “VAT EMTY” “YES NO”.
12. Once vat is empty, press √ button and display shows “SCRUB VAT COMPLETE” “YES NO”. Use brush to clean element and scour pad to clean vat, if needed.



*Do not scrape the electric fryer elements, or use scouring pads on the elements. This produces scratches on the surface of the element causing breading to stick and burn.*

*Do not use steel wool, other abrasive cleaners, or cleaners/sanitizers containing chlorine, bromine, iodine, or ammonia chemicals as these will deteriorate the stainless steel material and shorten the life of the unit.*

*Do not use a water jet (pressure sprayer) to clean unit or component damage could result.*



Use the lift tool and lift the elements from the vat as needed. (Auto-lift fryers, hinge back the basket hooks over the top of the fryer before lifting the elements.)

13. Once vat is clean, press the √ button and display shows “RINSE VAT”. (If drain is not open, display shows “OPEN DRAIN” Open the drain.)
14. Pour clean water and approximately 8 ozs. (0.24 liters) of distilled vinegar solution into vat to rinse vat and allow rinse water to drain into drain pan. Rinse at least 3 times, but be careful not to overfill the drain pan. Display now shows “RINSE COMPLETE” “YES NO”
15. Once vat is completely rinsed, press the √ button and display shows “CLEAR SOLUTION FROM OIL LINES” “√ =PUMP” “X =DONE”

To make sure no cleaning solution remains in the oil lines, press and hold √ button for a few seconds. Once lines are clear, press X button and display shows “VAT DRY?” “YES NO”. Push drain knob and close drain.

16. Pull drain pan from under fryer and dispose of rinse water.



**Figure 1**

**3-17. CLEAN-OUT MODE**  
**(Continued)**

17. Thoroughly dry the vat with a towel, and then press the √ button. Controls return to normal operations.

**CAUTION**

*Make sure the inside of the vat, the drain valve opening, and all the parts that come in contact with the new oil are as dry as possible.*

18. Make sure the drain is closed and return the filter pan assembly, with new filter pad, to the fryer. Fill vat with oil following the **Filling or Adding Oil** instructions from Section 3-3.

**3-18. CHECK/REPLACE FILTER DRAIN PAN O-RINGS**

To prevent oil leaking, and to keep filtering process operating properly, the filter drain pan o-rings should be inspected for nicks and tears at least every 3 months. Figure 1



**Figure 1**

1. Open the door, lift-up on the drain pan stop and pull-out the filter drain pan assembly, using the handle on the drain pan. Figures 2 & 3

**WARNING**  
**BURN RISK**

**This pan could be hot! Use protective cloth or glove, or severe burns could result.**



**Figure 2**

2. Visually check the 3 o-rings on the tube of the filter drain pan for any cracks or breaks and replace if necessary.
3. To replace o-ring, use a small, flat-bladed screwdriver, pry up on the o-ring and pull off of end of tube. Roll new o-ring into notch on tube. Before pushing the filter drain pan back into position, lubricate the o-rings on the filter tube with fresh, cold oil.



**Figure 3**



**Figure 4**

### 3-19. INFO BUTTON STATS

#### **Actual Oil Temperature**

1. Press  and the actual oil temperature shows in the display, for each vat.

#### **Set-point Temperature**

2. Press  twice and SP shows in the display, along with the set-point (preset) temperature of each vat.

#### **Recovery Information for each Vat**

1. Press  3 times and REC shows in the left display and the recovery time that oil temperature went from 250°F (121°C) to 300°F (149°C) shows in the right display. For example, 

REC	5:30
-----	------

 means it took 5 minutes and

30 seconds for the oil temperature to recover to 300°F (149°C) from 250°F (121°C).

### NOTICE

If no buttons are pressed within 5 seconds in any of stats modes, the controls revert back to normal operation.

### 3-20. FILTER BUTTON STATS

#### **Cook Cycles Remaining before Filtering**

1. Press and release either  button and the left display shows “COOKS REMAINING” and the right display shows the number of cook cycles before the next auto filter. For example, 

REMA	INING	3	6
------	-------	---	---

means after 3 more cook cycles on the left vat, the controls asks the operator if they are ready to filter or not. But, 6 more cook cycles remain on the right vat.

#### **Time and Date**

2. Press either  twice and ‘FILTERED’ shows in the displays, along with the time-of-day and date of the last filter.

**3-21. PREVENTIVE  
MAINTENANCE  
SCHEDULE**

As in all food service equipment, the Henny Penny open fryer does require care and proper maintenance. The table below provides a summary of scheduled maintenance procedures to be performed by the operator.

<b>Procedure</b>	<b>Frequency</b>
Filtering of shortening (Section 3-11)	Daily
Changing the filter pad (Section 3-13)	Daily
Lubricate filter pan o-rings	Every filter pad change
Lubricate EEE-141 oil reservoir o-rings	When reservoir is removed
Changing of oil	When oil smokes, foams up violently, or tastes bad
Cleaning the vat (Section 3-15)	Every change of oil
Inspect filter pan o-rings (Section 3-16)	Quarterly
Inspect EEE-141 reservoir o-rings (Section 3-10)	Quarterly

## SECTION 4. INFORMATION MODE

This historic information can be recorded and used for operational and technical help and allows you to view the following:

- 1. E-LOG
- 2. LAST LOAD
- 3. DAILY STATS
- 4. OIL STATS
- 5. REVIEW USAGE
- 6. INPUTS
- 7. OUTPUTS
- 8. OIL TEMP
- 9. CPU TEMP
- 10. COMMUNICATION INFO
- 11. ANALOG INFO
- 12. ACTIVITY LOG
- 13. OIL LEVELS
- 14. PUMP VALVE INFO
- 15. AIF INFO

### NOTICE

Not all Information Mode functions are discussed in this section. To ensure proper operation of fryer, please consult Henny Penny Corp. before changing any of these settings. For more information on these functions, contact Technical Support at 1-800-417- 8405, or 1-937-456-8405.

#### 4-1. INFORMATION MODE DETAILS

##### 1. E-LOG (error code log)

Press  and  buttons at the same time and “\*INFO

MODE\*” shows in the display, followed by “1. E-LOG”.

### NOTICE

Press  and  to exit Information Mode at any time.

Press  and “A. (date & time) \*NOW\* show in displays.

This is the present date and time.

Press  and if a error was recorded, “B. (date, time, and error code information)” shows in display. This is the latest error code that the controls recorded.

Press  and the next latest error code information can be seen.



Up to 10 error codes (B to K) can be stored in the E-LOG section.



**4-1. INFORMATION MODE  
DETAILS (Continued)**

**2. LAST LOAD** (Information on recent cook cycles)

Press  and “2. LAST LOAD” show in displays.

Press a timer button  or  for the product you want to view the cook data and the LED flashes.

Press  button to start viewing the cook data.

For example, if the left  LED is flashing, “PRODUCT FRY L1” show in displays.

If the right  LED is flashing, “PRODUCT FRY R2” show in displays.

Press  button to start viewing the cook data.

FUNCTION	DISPLAY EX:
Product (Last product cooked)	PRODUCT FRY L1
Time of day the last Cook Cycle was started	STARTED FEB 4 2:25P
Actual Elapsed cook Time (Real seconds)	ACTUAL TIME 1:06
Programmed cook Time	PROG TIME 1:00
Max Temp during Cook Cycle	MAX TEMP 350°F
Min Temp during Cook Cycle	MIN TEMP 313°F
Avg Temp during Cook Cycle	AVG TEMP 322°F
Heat On (percentage) during Cook Cycle	HEAT ON 45%
Ready? (Was fryer Ready before start?)	READY? YES
When Cook Cycle was stopped: Early	QUIT AT 0:10 REM OR
After complete Cook Cycle	*DONE* +6 SEC
Difference (%) between actual and programmed cook time	ACT/PROG 1%

**4-1. INFORMATION MODE  
DETAILS (Continued)**

**3. DAILY STATS** (Operational info of fryer for last 7 days)

Press  and “3. DAILY STATS” show in displays.

Press  button to start viewing the cook data.

Press the right  to view data for other days of week.

FUNCTION	DISPLAY EX:
Day this data was recorded for	APR-30 TUE*
Number of Hours:Minutes the fryer was on	(L/R) ON HRS TUE* 3:45
Number of times filtered	(L/R) FILTERED TUE* 4
Number of times filter skipped	(L/R) SKIPPED TUE* 4
Number of times oil added	(L/R) ADD OIL TUE* 4
Number of times oil discarded	(L/R) DISPOSE TUE* 0
Oil temperature recovery time	(L/R) RECOVERY TUE*1:45
Total number of cook cycles that day	(L/R) TOT CK TUE* 38
Number of cycles stopped before *DONE*	QUIT CK TUE* 2
Cook Cycles for Product #1	TUE* COOK -1- 17
Cook Cycles for Product #2	TUE* COOK -2- 9
Cook Cycles for Product #3	TUE* COOK -3- 5
Cook Cycles for Product #4	TUE* COOK -4- 0
Cook Cycles for Product #5	TUE* COOK -5- 0
Cook Cycles for Product #6	TUE* COOK -6- 6
Cook Cycles for Product #7	TUE* COOK -7- 0
Cook Cycles for Product #8	TUE* COOK -8- 0
Cook Cycles for Product #9	TUE* COOK -9- 1
Cook Cycles for Product #0	TUE* COOK -0- 0

**4-1. INFORMATION MODE**  
**DETAILS (Continued)**

**4. OIL STATS** (info of current oil and avg. of last 4 batches of oil)

Press  and “4. OIL STATS” show in displays.

Press  button to start viewing the cook data.

FUNCTION	DISPLAY EX:
Start date of new oil	NEW OIL                      MAR-23
Number of days oil in use	(L/R) OIL USE              4 DAYS
Number of filters on this oil	(L/R) FILTERED            4
Number of times filter skipped	(L/R) SKIPPED             0
Number of cook cycles on this oil	(L/R) TOT CK                38
Average number of days per oil change	(L/R) AVG DAYS PER OIL CHANGE    13.8 DAYS
Average number cook cycles per oil change	(L/R) AVG CKS PER OIL CHANGE                388 CKS

Press and hold a product button (1 to 4) to view the data from one of the previous 4 batches of oil used.

Press  to view oldest oil data:              Ex: OIL-4    14 DAYS

Press  to view 3rd oldest oil data:            Ex: OIL-3    12 DAYS

Press  to view 2nd oldest oil data:            Ex: OIL-2    15 DAYS

Press  to view previous batch of oil: Ex: OIL-1    13 DAYS

**4-1. INFORMATION MODE  
DETAILS (Continued)**

**5. REVIEW USAGE**(accumulated info since the data was reset)  
Press  and “4. REVIEW USAGE” show in displays.

Press  button to start viewing the cook data.

FUNCTION	DISPLAY EX:
Day the usage data was previously reset	SINCE APR-19 3:00P
Number of Hours the fryer was on	(L/R) ON HRS 4
Number of times filtered	(L/R) FILTERED 4
Number of times filter skipped	(L/R) SKIPPED 0
Number of times oil added	(L/R) ADD OIL 4
Number of times oil discarded	(L/R) DISPOSE 1
Total number of cook cycles	(L/R) TOT CK 38
Number of cycles stopped before *DONE*	QUIT CK 2
Cook Cycles for Product #1	COOK -1- 17
Cook Cycles for Product #2	COOK -2- 9
Cook Cycles for Product #3	COOK -3- 5
Cook Cycles for Product #4	COOK -4- 0
Cook Cycles for Product #5	COOK -5- 0
Cook Cycles for Product #6	COOK -6- 6
Cook Cycles for Product #7	COOK -7- 0
Cook Cycles for Product #8	COOK -8- 0
Cook Cycles for Product #9	COOK -9- 1
Cook Cycles for Product #0	COOK -0- 0
<b>Reset usage data:</b> Enter the Usage Code - 1, 2, 3 on this step to zero out all the usage information	RESET USAGE / ENTER CODE -----

## SECTION 5. PRODUCT PROGRAM MODE





This mode allows you to program the following:

- Change Product Name
- Assign Button
- Change Times & Temp
- Change Cook ID
- Alarms
- Quality Timers
- Include in Filter Count (Global)
- Filter at X no. of loads (Mixed)
- Load Compensation
- Load Compensation Reference
- Full Heat
- PC Factor

### 5-1. MODIFYING PRODUCT SETTINGS

1. Press and hold  button until “PROG” shows in the display, followed by “ENTER CODE”.
2. Enter code 1, 2, 3 (first 3 product buttons). “PRODUCT” and “PROGRAM” show in the displays, followed by “SELECT PRODUCT” and “-P 1-” (ex: NUG).

#### **Change Product Names**

3. Use the  and  buttons to scroll through the 40 products, or press the desired product button.
4. Press  button and “NAME” shows in the left display and the product (ex: NUGGETS) shows in the right display.
5. Press  button and the first letter in the name flashes. Press a product button and the flashing letter changes to the first letter under the product button that was pressed. For example, if  is pressed, the flashing letter changes to an “A”.

Press the same button again and the flashing letter changes to a “B”. Press it again and the flashing letter changes to a “C”.

Once the desired letter shows in the display, press  button to continue to the next letter and repeat the procedure.

Press and hold the right **X** button to exit Program Mode, or press  button to continue on to “COOK TIME”.

#### **Assign Button**

6. Press  button until “ASSIGN BTN” shows in the display, along with the product (ex: NUGGETS). If this product already has a product button assigned to it, that LED will be lit. To assign other product buttons to that product, press and hold the product button for 3 seconds and that LED stays lit. To remove a product from a button, press and hold the product button with a lit LED and the LED goes out.

## **5-1. MODIFYING PRODUCT SETTINGS (Continued)**

### **To Change Times and Temperatures**

7. Press ► button until “COOK TIME” shows in the display, and then use the product buttons, or the ▲ and ▼ buttons, to change the time in minutes and seconds, to a maximum of 59:59.
8. Press ► button and “TEMP” shows in the display, along with the preset temperature on the right side of the display.

Press the product buttons, or the ▲ and ▼ buttons, to change the temperature. The temperature range is 190°F (88°C) to 375°F (191°C).

### **Cook ID Change**

9. Press ► button until “COOK ID” shows in the display along with the product ID. For example, NUG would be the ID for nuggets. Use the product buttons, or the ▲ and ▼ buttons, to change the ID.

### **Alarms (1 & 2)**

11. Press ► button until “ALRM 1” shows in the left display, and an alarm time in the right display. Press the product buttons, or the ▲ and ▼ buttons, to set an alarm.

Ex., If a Cook Cycle was set at 3 minutes, and an alarm was to go off after 30 seconds into the Cook Cycle, “2:30” would be set in the display at this time. When the timer counts down to 2:30 the alarm sounds.

After the alarm time is set, press ► button and “ALRM 2” shows in the display, and a second alarm can be programmed.

### **Quality Timer (hold time)**

12. Press ► button until “QUAL TMR” shows in the display along with the preset holding time. Press the product buttons, or the ▲ and ▼ buttons, to adjust holding time, up to 59:59.

### **Global Filter Tracking**

#### **Include in Filter Count**

- 13a. Press ► button until “INCL IN FLTR CNT” flashes in the display along with “YES” or “NO”. Using ▲ and ▼ buttons, change the display to “YES” if that product’s Cook Cycles are to be counted as part of the recommended filter process. Set to “NO” if it is not to be included.

**5-1. MODIFYING PRODUCT SETTINGS (Continued)**



Mixed Filter Tracking



**Filter After X Number of Loads**



13b. Press  button until “FILTER AFTER...” flashes in the left display along, and the number of cook cycles between filters shows in the right display. Press the product buttons, or the  and  buttons, to change this value of 0 to 99 loads. This needs set for each product.



**>Load Compensation, Load Compensation Reference, Full Heat, PC Factor<**

14. Press  button until “LD COMP” shows in the display, along with the load compensation value. This automatically adjusts the time to account for the size and temperature of the cooking load.



Press the product buttons, or the  and  buttons, to change this value of 0 to 20.

15. Press  button until “LCMP REF” shows in the display along with the load compensation average temperature. (if load compensation is set to “OFF”, then “\_\_\_” shows in display and setting cannot be programmed) This is the average cooking temperature for each product. The timer speeds up at temperatures above this setting and slows down at temperatures below this setting. Press the product button, or the  and  buttons, to change this value.

16. Press  button until “FULL HT” shows in the display along with the full heat value in seconds, which means the heat is on as soon as a timer button is pressed, for the programmed length of time. Press the product buttons, or the  and  buttons, to change this value of 0 to 90 seconds.

17. Press  button until “PC FACTR” shows in the display along with the proportional temperature, which helps to keep the oil from over-shooting the setpoint temperature. Press the product buttons, or the  and  buttons, to change this value of 0 to 50 degrees.

**NOTICE**

- Use  button to go back to previous menu items.
- Press  button when finished with the current product, to return to the “SELECT PRODUCT” step.
- Press and hold  button to exit PRODUCT PROGRAM Mode.

## SECTION 6. LEVEL 2 PROGRAMMING

Used to access the following:

- Special Program Mode
- Clock Set
- Data Communication
- Heat Control
- Tech Mode
- Stats
- Filter Control

### **6-1. SPECIAL PROGRAM MODE**

The Special Program Mode is used to set more detailed programming, such as:

- SP-1** • Degrees Fahrenheit or Celsius
- SP-2** • Language: English, Russian, Swedish (SVENSKT), German (DEUTSCHE), Portuguese, Spanish (ESPAÑOL) and French (FRANCAIS)
- SP-3** • System Initialization (Factory Presets)
- SP-4** • Audio Volume
- SP-5** • Audio Tone
- SP-6** • Melt Cycle Select - 1.LIQUID; 2.SOLID
- SP-7** • Idle Mode Enabled - YES or NO
- SP-7A** • Use “0” for IDLE
- SP-7B** • Auto Idle Minutes
- SP-7C** • Idle Set-point Temperature
- SP-8** • Filter Tracking Mode - 1.MIXED or 2.GLOBAL
- SP-8A** • Suggest Filter At... - 75% to 100% (**MIXED**)
- SP-8B** • Filter Lockout Enabled? - YES or NO (**MIXED**)
- SP-8A** • Left Vat Filter Cycles - 0 to 99 (**GLOBAL**)
- SP-8B** • Right Vat Filter Cycles - 0 to 99 (**GLOBAL**)
- SP-8C** • Filter Lockout Enabled? - YES or NO (**GLOBAL**)
- SP-9** • Polish Duration - X:XXM:SS
- SP-10** • Change Pad Reminder Time - XX HRS
- SP-11** • Clean-Out Time - XX MIN
- SP-12** • Clean-Out Temperature - XXX °F or °C
- SP-13** • Cooking User IO - After Cook Cycle, display shows previous menu item or “----”
- SP-14** • Number of Baskets - 2-BASKETS or 4 BASKETS
- SP-15** • Show Cooking Indicator - YES or NO
- SP-16** • 2nd Language: English, Russian, Swedish (SVENSKT), German (DEUTSCHE), Portuguese, Spanish (ESPAÑOL) and French (FRANCAIS)
- SP-17** • 2nd Audio Volume
- SP-18** • Energy Save Enabled? - YES or NO
- SP-19** • Fryer Type - GAS or ELECTRIC
- SP-20** • Vat Type - SPLIT or FULL
- SP-21** • Autolift Enabled? - NO LIFT or YES LIFT
- SP-22** • Bulk Oil Supply? - YES or NO
- SP-23** • Bulk Oil Dispose? - YES or NO
- SP-24** • Serial No. of Fryer
- SP-25** • Change Mgr. Code- 1 = YES
- SP-26** • Change Usage Code - 1 = YES
- SP-27** • Dispose Requires Code ? - YES or NO
- SP-28** • Longer Fill Time Enabled - YES or NO
- SP-29** • Let User Exit Fill? - YES or NO



## **6-1. SPECIAL PROGRAM MODE (Continued)**

Press and hold the **P** button for 5 seconds until “LEVEL 2” followed by, “SP PROG” and “ENTER CODE” show in the display.

Enter code 1,2,3, and “SP-1”, “TEMP”, “FORMAT” show in the displays.

### **NOTICE**

If a bad code is entered, a tone sounds and “BAD CODE” shows on the display. Wait a few seconds, the controls revert back to the cook mode, and repeat the above steps.

To exit from the Special Program Mode at any time, press and hold **P** button for 2 seconds.

### **Degrees Fahrenheit or Celsius (SP-1)**

The left display flashes “SP-1” and “TEMP”, “FORMAT”. Press the ▲ or ▼ buttons to choose °F or °C.

### **NOTICE**

- Use ◀ button to go back to previous menu items
- Press ▶ button when finished with the current Level 2 step

### **Language (SP-2)**

Press ▶ button and “SP-2” and “LANGUAGE” flash on the left display. Press the ▲ or ▼ buttons to select the desired language.

### **System Initialization (SP-3)**



Press ▶ button and “SP-3” and “DO SYSTEM INIT” flash in the display, along with “INIT” on the right display. To reset the controls to factory default settings, press and hold √ button and control counts down “IN 3”, “IN2”, “IN 1”. Once display shows “-INIT-” & \*DONE\* the controls are reset to factory defaults.

### **Audio Volume (SP-4)**

Press ▶ button and “SP-4” and “VOLUME” flash in the left display. Press the ▲ or ▼, or use product buttons, to adjust the volume of the speaker, 10 being the maximum value and 1 the minimum.

## **6-1. SPECIAL PROGRAM** **MODE (Continued)**

### **Audio Tone (SP-5)**

Press  button and “SP-5” and “TONE” flash in the left display. Press the  or , or use product buttons, to adjust the tone of the speaker, 2000 being the maximum value and 50 the minimum.



### **Liquid or Solid Cooking Oil Used (SP-6)**





Press  button until “SP-6 MELT CYCLE SELECT” scrolls in the left display. Unless solid oil is being used in the vats the right display should show “1.LIQUID”.



If solid oil is used, the unit **MUST BE** equipped to handle solid oil. Use the  and  buttons to change the right display to “2.SOLID”

### **Idle Mode Enabled (SP-7)**



An Idle Mode allows the oil temperature to drop to a lower temperature when not in use. This saves on oil and utilities.

Press  button and “SP-7” and “IDLE MODE ENABLED?” flash in the left display. Press the  or  buttons to choose YES” or “NO”.

With “YES” in the display, press  button and “SP-7A” and “USE ‘0’ FOR IDLE” flash on the left display. Press the  or  buttons to select “YES” or “NO”. If “YES” is selected, an Idle Mode can be programmed in product button .

Press  button and “SP-7B” and “AUTOIDLE MINUTES” flash in the left display. Press the  or , or use product buttons, to set the time (0 to 60 minutes) fryer stays idle before the auto-idle is enabled.

Ex., “30” means, if product is not cooked in that vat for 30 minutes, the control automatically cools the oil down to the idle setpoint temperature

Press  button and “SP-7C” and “IDLE SETPT” flash in the left display. Press the  or , or use product buttons, to set the idle temperature 200° to 375 °F (93 to 191 °C).

**6-1. SPECIAL PROGRAM  
MODE (Continued)**

Product	No. Cook Cycles	Cycle Count
Fish	2	1/2
French Fries	8	1/8
Chicken	4	1/4

**Filter Tracking Mode (SP-8)**

Filter Tracking signals the operator when the oil needs filtering by counting the number Cook Cycles between filters

Press **▶** button and “SP-8” and “FILTER TRACKING MODE” show in the display. Use the **▲** and **▼** buttons to choose either “1.MIXED” filter tracking or “2.GLOBAL”.

**NOTICE**

GLOBAL means all the products have the same number of cook cycles between filters.

MIXED means each product may be set with different number of cook cycles between filters. The controls adds the cycle counts (see example at left) and when the counts equal 1 or greater, filtering is suggested. Ex: 1 load of fish, 2 loads of french fries, a load of chicken equals 1.  $1/2 + 1/8 + 1/8 + 1/4 = 1$ .

**MIXED**

If MIXED is selected, press **▶** button and “SP-8A” and “SUGGEST FILTER AT ...” shows in the left display, and a value between 75% and 100% shows on the right display. Press the **▲** and **▼** buttons to change this value.

The lower the value, the sooner the control recommends to filter. Ex: If set to 75%, the control suggest filtering after 3/4 of the programmed cook cycles is met, whereas at 100%, all the cook cycles must be completed before the control suggest filtering.

Press **▶** and “SP-8B” and “LOCKOUT ENABLED?” shows in the left display. Press the **▲** and **▼** buttons to choose YES or NO.

If set to YES, when the controls suggest filtering, “FILTER LOCKOUT”/”YOU \*MUST\* FILTER NOW”, shows in the display, and it refuses further cook cycles until the vat is filtered.

Press **▶** and “SP-8C” and “LOCKOUT AT...” shows in the left display and a value between 100% and 250% shows on the right display. Press the **▲** and **▼** buttons to change this value. The lower the value, the sooner the “lockout” occurs.

Ex: If set at 100%, “lockout” occurs when the cycle counts reaches 1 or greater. Set at 200%, twice as many cycles are counted before “lockout” occurs. See example above.



**6-1. SPECIAL PROGRAM**  
**MODE (Continued)**

**Filter Tracking Mode (SP-8) (Continued)**



**GLOBAL**



If GLOBAL is selected, press  button.



Split Vat

If unit is a split vat, “SP-8A” and “LEFT VAT FILTER CYCLES” shows in the left display, and the number of cook cycles between filters shows on the right display (0 to 99). Use  and  or product buttons to change this number.

Press  button and “SP-8B” and “RIGHT VAT FILTER CYCLES” shows in the left display, and the number of cook cycles between filters shows on the right display (0 to 99).



Press  button and “SP-8C” and “LOCKOUT ENABLED?” shows in the left display. Press the  and  buttons to choose YES or NO.



If set to YES, press  button and the left display shows “SP-8D” and “LEFT VAT LOCKOUT CYCLES” and the number of cook cycles before filter lock-out shows on the right display (0 to 99). Use  and  or product buttons to change this number.



Press  button and the left display shows “SP-8E” and “RGHT VAT LOCKOUT CYCLES” and the number of cook cycles before filter lock-out shows on the right display (0 to 99). Use  and  or product numbers to change this number.

Once this number of cook cycles is reached, “FILTER LOCKOUT”/”YOU \*MUST\* FILTER NOW”, shows in the display, and it refuses further cook cycles until the vat is filtered.

Full Vat

If unit is a full vat, “SP-8A” and “FULL VAT FILTER CYCLES” shows in the left display, and the number of cook cycles between filters shows on the right display (0 to 99). Use  and  or product numbers to change this number.

Press  button and “SP-8B” and “LOCKOUT ENABLED?” shows in the left display. Press the  and  buttons to choose YES or NO.

If set to YES, press  button and the left display shows “SP-8C” and “FULL VAT LOCKOUT CYCLES” and the number of cook cycles before filter lock-out shows on the right display (0 to 99). Use  or product buttons to change this number.

Once this number of cook cycles is reached, “FILTER LOCKOUT”/”YOU \*MUST\* FILTER NOW”, shows in the display, and it refuses further cook cycles until the vat is filtered.

## **6-1. SPECIAL PROGRAM** **MODE (Continued)**

### **Polish Duration (SP-9)**

Press ► button and “SP-9” and “POLISH TIME” flash in the left display. Press the ▲ or ▼, or use product buttons, to change the polish time, from 0 to 10 minutes.

### **Change Filter Pad Reminder Time (SP-10)**

Press ► button and “SP-10 ‘CHANGE PAD’ REMINDER” flash in the left display. Press the ▲ or ▼, or use product buttons, to change the time, from 0 hours to a maximum of 100 hours.

### **Clean-Out Time (SP-11)**

Press ► button and “SP-11 CLEAN-OUT TIME” flashes in the left display. Press the ▲ or ▼ or use product buttons, to change the time from 0 to 99 minutes.

### **Clean-Out Temperature (SP-12)**

Press ► button and “SP-12 CLEAN-OUT TEMP” flashes in the left display. Press the ▲ or ▼ or use product buttons, to change the temperature from 0 to 195°F (90°C).

### **Cooking User IO (SP-13)**

Press ► button and “SP-13” and “COOKING USER IO” flash in the display. Press the ▲ or ▼ buttons to choose “SHOWPREV” or “SHOW----”.

Setting SP-13 to SHOWPREV means after a cook cycle the display shows the last menu item cooked. SHOW---- means after a cook cycle “----” shows in the display and a menu item needs selected before starting the next cook cycle.

### **Number of Baskets (SP-14)**



Press ► button and “SP-14 NUMBER OF BASKETS” flashes in the left display. Press the ▲ or ▼ buttons to choose 2 or 4 baskets per well.

### **Cooking Indicator (SP-15)**

Press ► button and “SP-15 SHOW COOKING INDICATOR” flashes in the left display. Press the ▲ or ▼ buttons to choose YES, and during a cook cycle, “\*” shows which timer is counting-down. Choose NO and “\*” will not show during a cook cycle.

## **6-1. SPECIAL PROGRAM MODE (Continued)**



### **2nd Language (SP-16)**

Press  button and “SP-16 2ND LANGUAGE” flashes on the left display. Press the  or  buttons to select the desired 2nd language.

By setting a 2nd language in the controls, 2 languages can now be chosen by pressing  button during normal operation.

One language shows in the left display and the second language shows in the right display. Pressing the  button selects the language in the displays.



### **2nd Volume (SP-17)**

Press  button and “SP-17 2ND VOLUME” flashes on the left display. Press the  or  buttons, or the product buttons to select the desired 2nd volume.

By setting a 2nd volume in the controls, 2 volumes can now be chosen by pressing  button twice during normal operation.



One volume setting shows in the left display (NONE to 10; 10 being the loudest) and the second volume shows in the right display. To select the volume, press the  button under the desired volume .

### **Engery Save Mode (SP-18)**



Press  button and “SP-18 ENERGY SAVE ENABLED?” flashes in the left display. Press the  or  buttons to choose “YES” or “NO”.

If set to YES, during times of non-use the fryer automatically starts an Energy Save Mode, which turns-off the blowers. Then once a product is selected to start a cook cycle, the blowers and heat come back on. If set to NO, the blowers are on constantly.

### **Fryer Type (SP-19)**



Press  button and “SP-19 FRYER TYPE” flashes in the left display. Press the  or  buttons to choose “GAS” or “ELEC”.

### **Vat Type (SP-20)**



Press  button and “SP-20 VAT TYPE” flashes in the left display. Press the  or  buttons to choose “SPLIT” or “FULL”.

**6-1. SPECIAL PROGRAM  
MODE (Continued)**



**Autolift Enabled (SP-21)**

Press  button and “SP-21 AUTOLIFT ENABLED?” flashes in the left display. Press the  or  buttons to choose “YES LIFT” or “NO LIFT”. If fryer is fitted with the auto-lift option, SP-21 must be set to “YES LIFT”, otherwise, set SP-21 to “NO LIFT”.



**Bulk Oil Supply (SP-22)**

Press  button and “SP-22 BULK OIL SUPPLY?” flashes in the left display. Press the  or  buttons to choose “YES SUPL” or “NO SUPL”. Set to YES if the oil is pumped into the vats from an outside oil reservoir. Otherwise, set SP-22 to NO.

**Bulk Oil Disposal (SP-23)**



Press  button and “SP-23 BULK OIL DISPOSE?” flashes in the left display. Press the  or  buttons to choose “YES DISP” or “NO DISP”. Set to “YES DISP” if the oil is pumped from the vats to an outside oil reservoir when discarding the oil. Otherwise, set SP-23 to “NO DISP”.

**Serial Number Log (SP-24)**

Press  button and “SP-24” and “S/N  EDIT” flash in the displays, along with the serial number of the unit. THIS SERIAL NUMBER SHOULD MATCH THE SERIAL NUMBER ON THE DATA PLATE, ON THE DOORS. IF NOT, IT CAN BE RECORDED.

**Program Code Change (SP-25)**

This allows the operator to change the program code (factory set at 1, 2, 3) used to access Product Programming and Level 2 Program Mode.

Press  button and “SP-25” and “CHANGE MGR CODE? 1=YES” flash in the display. Press  and “ENTER NEW CODE, P=DONE, I=QUIT” show scrolls through the display. Press the product buttons for new code.

If satisfied with code, press  and “REPEAT NEW CODE, P=DONE, I=QUIT, shows in display. Press same code buttons.

## **6-1. SPECIAL PROGRAM MODE (Continued)**

### **Program Code Change (SP-25) (Continued)**

If satisfied with code, press **P** and “\*CODE CHANGED\*” shows in display.

If not satisfied with code, press **i** and “\*CANCEL” shows in display, then reverts back to “SP-25” and “CHANGE, MGR CODE? 1=YES”. Now the above steps can be repeated.

### **Usage Code Change (SP-26)**

This allows the operator to change the reset usage code (factory set at 1, 2, 3) to reset the usage amounts of each product. See Review Usage step in Information Mode.

Press **▶** button and “SP-26 CHANGE USAGE CODE? 1=YES” flashes in the display. Press **i** and “ENTER NEW CODE, P=DONE, I=QUIT show scrolls through the display. Press the product buttons for new code.

If satisfied with code, press **P** and “REPEAT NEW CODE, P=DONE, I=QUIT, shows in display. Press same code buttons.

If satisfied with code, press **P** “\*CODE CHANGED\*” shows in display.

If not satisfied with code, press **i** and “\*CANCEL” shows in display, then reverts back to “SP-26” and “CHANGE, USAGE CODE? 1=YES”. Now the above steps can be repeated.

### **Dispose Requires Code ? (SP-27)**

Press **▶** button and “SP-27 DISPOSE REQUIRES CODE ?” flashes in the left display. Press the **▲** or **▼** buttons to choose YES or NO. If set to YES, code 1, 2, 3 must be entered to discard the oil from the vat, using the Dispose Mode.

### **Longer Fill Time (SP-28)**

Press **▶** button and “SP-28 LONGER FILLTIME ENABLED?” flashes in the left display. Press the **▲** or **▼** buttons to choose YES or NO.

### **Let User Exit Fill (SP-29)**

Press **▶** button and “SP-29 LET USER EXIT FILL” flashes in the left display. Press the **▲** or **▼** buttons to choose YES or NO. If YES is chosen, the user can exit the Express Filter™ fill operation.



## **6-2. CLOCK SET**



1. Press and hold the **P** button for 5 seconds until “LEVEL 2”, followed by, “SP PROG” and “ENTER CODE” show in the display.
2. Press the **P** button again and “CLK SET” and “ENTER CODE” flash in the left display.
3. Enter code 1, 2, 3 (first 3 product buttons).
4. “CS-1 ENTER DATE MM-DD-YY” flashes in the left display. Use the product buttons to set the date in the right display.
5. Press **▶** button and “CS-2 ENTER TIME” flashes in the left display and the time flashes in the right display. Press the **▲** or **▼**, or use product buttons, to change the time.
6. Press **▶** button and “CS-2 ENTER TIME” flashes in the left display and “AM” or “PM” flashes in the right display. Use the **▲** or **▼** buttons to choose AM or PM.
7. Press **▶** button and “CS-3 TIME FORMAT” flashes in the left display and “12-HR” or “24-HR” shows in the right display. Use the **▲** or **▼** buttons to choose a 12 hour time format or a 24 hour time format.
8. Press **▶** button and “CS-4 DAYLIGHT SAVING TIME” flashes in the left display. Use the **▲** or **▼** buttons to choose daylight saving time for your area: 1.OFF; 2.US (2007 & after); 3.EURO; or 4.FSA (US before 2007).

## **6-3. DATA LOGGING, HEAT CONTROL, TECH, STAT, AND FILTER CONTROL MODES**

The Data Logging, Heat Control, Tech, Stat and Filter Control Modes are advanced diagnostic and program modes, mainly for Henny Penny use only. For more information on these modes, contact the Service Department at 1-800-417-8405 or 1-937-456-8405.

**SECTION 7. TROUBLESHOOTING**

**7-1. TROUBLE SHOOTING GUIDE**

Problem	Cause	Correction
POWER switch ON but fryer completely inoperative	<ul style="list-style-type: none"> <li>• Open circuit</li> </ul>	<ul style="list-style-type: none"> <li>• Plug fryer in</li> <li>• Check breaker or fuse at supply box</li> <li>• Circuit breakers in fryer tripped-Open left door and reset circuit breakers on fryer; See below</li> </ul> 
Control error code “E-10”	<ul style="list-style-type: none"> <li>• Open high limit circuit</li> </ul>	<ul style="list-style-type: none"> <li>• Reset the high limit by using a small screwdriver or Allen wrench, gently pushing it into the hole in the heating element hinge; if high limit does not reset, high limit may need replaced</li> </ul> 
Vat is under-filled	<ul style="list-style-type: none"> <li>• JIB is low or empty</li> <li>• JIB oil line is clogged or collapsed</li> <li>• Filter pan needs cleaned</li> </ul>	<ul style="list-style-type: none"> <li>• Fill the JIB</li> <li>• Check JIB line</li> <li>• Check JIB tube &amp; connection</li> <li>• Clean filter pan and change paper or pad</li> </ul>

**7-1. TROUBLE SHOOTING GUIDE**

**(Continued)**

<b>Problem</b>	<b>Cause</b>	<b>Correction</b>
Oil foaming or boiling over top of vat	<ul style="list-style-type: none"> <li>• Water in oil</li> <li>• Improper or bad oil</li> <li>• Improper filtering</li> <li>• Improper rinsing after cleaning the vat</li> </ul>	<ul style="list-style-type: none"> <li>• Drain and clean oil</li> <li>• Use recommended oil</li> <li>• Refer to filtering procedures</li> <li>• Clean and rinse vat and then dry thoroughly</li> </ul>
Oil will not drain from vat	<ul style="list-style-type: none"> <li>• Drain valve clogged with crumbs</li> <li>• Drain trough clogged</li> </ul>	<ul style="list-style-type: none"> <li>• Open valve, force cleaning brush through drain</li> <li>• Remove right side panel and remove plug from end of trough and clean trough</li> </ul>
Filter motor runs but pumps oil slowly	<ul style="list-style-type: none"> <li>• Filter line connections loose</li> <li>• Filter paper or pad clogged</li> <li>• Filter not reassembled correctly</li> </ul>	<ul style="list-style-type: none"> <li>• Tighten all filter line connections</li> <li>• Change filter paper or pad</li> <li>• Refer to assembly instructions on inside of door</li> </ul>
Bubbles in oil during entire filtering process	<ul style="list-style-type: none"> <li>• Filter pan not completely engaged</li> <li>• Filter pan clogged</li> <li>• Damaged O-ring on filter line receiver on fryer</li> </ul>	<ul style="list-style-type: none"> <li>• Make sure filter pan return line is pushed completely into the receiver on the fryer</li> <li>• Clean pan and change paper or pad</li> <li>• Change O-ring</li> </ul>
Control error code “E-31”	<ul style="list-style-type: none"> <li>• Elements are up</li> </ul>	<ul style="list-style-type: none"> <li>• Lower elements completely into vat</li> </ul>
Filter motor will not run	<ul style="list-style-type: none"> <li>• Power cord for vat #1 is not plugged-in</li> <li>• Open circuit</li> <li>• the thermal reset button on the rear of the pump motor is tripped</li> </ul>	<ul style="list-style-type: none"> <li>• Plug power cord into receptacle</li> <li>• Check circuit breakers behind left door (beside control circuit breakers)-reset if needed</li> <li>• Allow time for the motor to cool and then, using a screwdriver, press hard against the button until it clicks</li> </ul> 

**7-2. ERROR CODES**

In the event of a control system failure, the digital display shows an error message. The message codes are shown in the DISPLAY column below. A constant tone is heard when an error code is displayed, and to silence this tone, press any button.

DISPLAY	CAUSE	CORRECTION
“E-4”	Control board overheating	Turn switch to OFF position, then turn switch back to ON; if display shows “E-4”, the control board is getting too hot; check the louvers on each side of the unit for obstructions
“E-5”	Oil overheating	Turn switch to OFF position, then turn switch back to ON; if display shows “E-5”, the heating circuits and temperature probes should be checked
“E-6A”	Temperature probe open	Turn switch to OFF position, then turn switch back to ON; if display shows “E-6A”, the temperature probe should be checked
“E-6B”	Temperature probe shorted	Turn switch to OFF position, then turn switch back to ON; if display shows “E-6B”, the temperature probe should be checked
“E-10”	High limit	Reset the high limit by using a small screwdriver or Allen wrench gently pushing it into the hole in the heating element hinge; if high limit does not reset, high limit may need be replaced 
“E-15”	Drain switch	Make sure drain knob is completely pushed-in; if E-15 persists, have drain switch checked
“E-18-A” “E-18-B” “E-18-C”	Left level sensor open Right level sensor open Both level sensors open	Turn switch to OFF position, then turn switch back to ON; if display still indicates a failed sensor, have the connectors checked at the control board; have sensor checked & replace if necessary

**7-2. ERROR CODES**

DISPLAY	CAUSE	CORRECTION
“E-21”	Slow heat recovery	Have a certified service technician check the fryer for correct voltage to the unit; have the contactors and heating element checked; have unit checked for loose or burnt wires
“E-22” “NO HEAT” “CHECK PWR CORD AND BREAKER”	Elements not heating	Check power cord and heat circuit
“E-31”	Elements are up	Lower elements completely back into the vat
“E-41”, “E-46”	Programming failure	Turn switch to OFF, then back to ON; if display shows any of these error codes, have the controls re-initialized; if error code persists, have the control board replaced
“E-47”	Analog converter chip or 12 volt supply failure	Turn switch to OFF, then back to ON; if “E-47” persists, have the I/O board, or the PC board replaced; if speaker tones are quiet, probably I/O board failure; have the I/O board replaced
“E-48”	Input system error	Turn switch to OFF, then back to ON; have control PC board replaced if “E-48” persists
“E-54C”	Temperature input error	Turn switch to OFF, then back to ON; have control PC board replaced if “E-54C” persists
“E-60”	AIF PC board not communicating with control PC board	Press power button to vat off and back on again if “E-60” persists, have the connector between the PC boards checked; replace AIF PC board or control PC board if necessary





**Henny Penny Corporation**  
**P.O.Box 60**  
**Eaton, OH 45320**

**1-937-456-8400**  
**1-937-456-8402 Fax**

**Toll free in USA**  
**1-800-417-8417**  
**1-800-417-8434 Fax**

**[www.hennypenny.com](http://www.hennypenny.com)**

\* FM05 - 053 - F \*

Henny Penny Corp., Eaton, Ohio 45320, Revised 5-19-10