

ELECTRIC SKILLET



Model Number:
169170
UPC: 681131691703

Customer Assistance
1 877 207 0923 (US)
1 877 556 0973 (Canada)



Thank you for purchasing this GE appliance.

In keeping with the GE ecomagination initiative, please consider the option to recycle the packaging material and donate any appliance you are no longer using.

To read more about GE's ecomagination commitment, visit:
ge.ecomagination.com

IMPORTANT SAFEGUARDS

When using electrical appliances, basic safety precautions should always be followed, including the following:

1. Read all instructions before using.
2. Do not touch hot surfaces. Use handles or knobs.
3. To protect against electrical shock, do not immerse temperature control probe, cord or plugs in water or other liquid.
4. Close supervision is necessary when any appliance is used near children. This appliance is not to be used by children.
5. Unplug from outlet when not in use and before cleaning. Allow to cool before putting on or taking off parts, and before cleaning.
6. Do not operate any appliance with a damaged cord or plug or after the appliance malfunctions or has been damaged in any manner. Call Customer Service (see warranty) to return for examination, repair, or adjustment.
7. The use of accessory attachments not recommended by manufacturer may cause injuries.
8. Do not use outdoors.
9. Do not let cord hang over edge of table or counter, or touch heated surfaces.
10. Do not place on or near a hot gas or electric burner, or in a heated oven.
11. Extreme caution must be used when moving any appliance containing hot oil or other hot liquids.
12. Always attach Temperature Control Probe to appliance first, then plug cord in the the wall outlet. To disconnect, turn control to "OFF", allow appliance and control probe to cool, then remove plug from wall.
13. Do not use appliance for other than intended use.

SAVE THESE INSTRUCTIONS!

ADDITIONAL SAFEGUARDS

CONSUMER SAFETY INFORMATION

THIS APPLIANCE IS INTENDED FOR HOUSEHOLD USE ONLY.

THIS APPLIANCE HAS NO USER-SERVICEABLE PARTS. THIS PRODUCT SHOULD ONLY BE SERVICED BY AN AUTHORIZED SERVICE REPRESENTATIVE.

WARNING

SERIOUS HOT-OIL BURNS MAY RESULT FROM A SKILLET BEING PULLED OFF A COUNTERTOP. DO NOT ALLOW THE CORD TO HANG OVER THE EDGE OF THE COUNTER WHERE IT MAY BE GRABBED BY CHILDREN OR BECOME ENTANGLED WITH THE USER.

DO NOT USE WITH AN EXTENSION CORD.

ELECTRICAL POWER

If electric circuit is overloaded with other appliances, skillet may not operate properly. Skillet must be operated on separate circuit from other operating appliances.

POLARIZED PLUG

This appliance has a polarized plug (one blade is wider than the other). To reduce the risk of electric shock, this plug is intended to fit into a polarized outlet only one way. If plug does not fit fully into the outlet, reverse the plug. If it still does not fit, contact a qualified electrician. Do not attempt to modify the plug in any way.

PARTS AND FEATURES

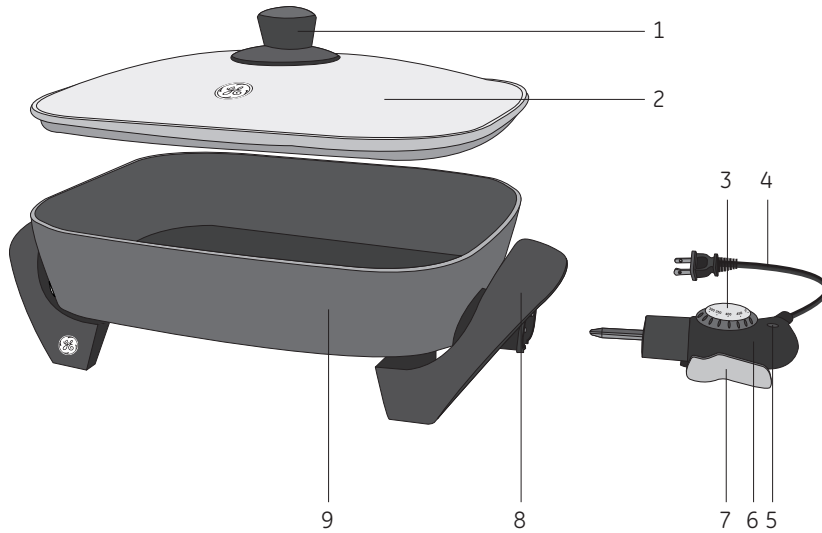



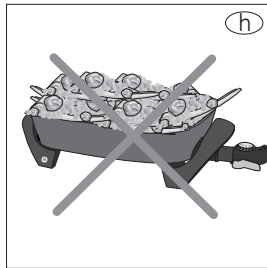
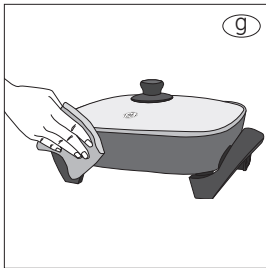
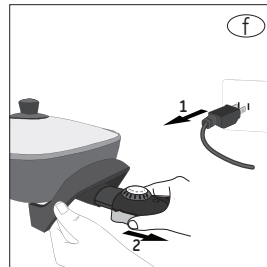
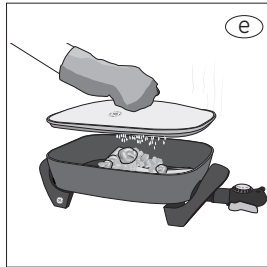
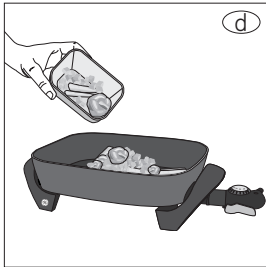
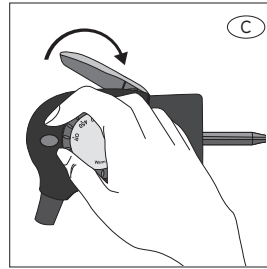
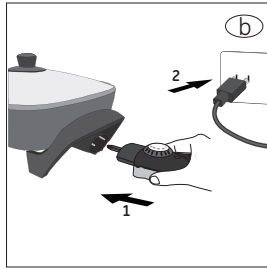
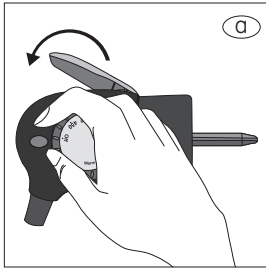

1. Lid handle
2. Glass lid
3. Control knob
4. Power cord with power plug
5. Power-on indicator light
6. Temperature Control Probe*
7. Temperature control release lever
8. Handles/Legs
9. Skillet

***NOTE:** Only use with the Temperature Control Probe model that is marked on the bottom of the temperature control probe guard.

ILLUSTRATIONS



HOW TO USE YOUR SKILLET

1. Turn temperature control to "OFF" (ill. ). Plug temperature control probe securely into receptacle on skillet, plug into standard 120v AC outlet (ill. ) and turn temperature control to desired setting (ill. .
2. The temperature control indicator light will come on when you set or adjust the temperature. Once the desired temperature is reached, the indicator light will cycle during use, indicating the selected temperature is being maintained. [When adding food (ill. )], the indicator light will come on briefly as the overall cooking temperature is reduced.]
3. Preheat the skillet with the lid on for 10 - 15 minutes or until the indicator light goes out.

NOTE: The cooking temperatures listed in this user manual are estimates. Adjust the cooking temperature slightly up or down to achieve the results you prefer. Do not over load or over fill skillet (ill. .

4. A steam vent is located on the lid. The steam vent allows steam to escape while cooking with the lid in place.

CAUTION: Escaping steam is hot! Be careful when removing or lifting lid (ill. .



NOTE: If heating oil, always leave the lid off. If oil smokes, immediately turn skillet "OFF" and allow to cool.

WARM SETTING

The temperature control probe has a "Warm" range setting of approximately 150°F to 180°F. The indicator light will cycle on and off when this setting is in use to indicate that the skillet is maintaining the desired temperature.

HOW TO CLEAN YOUR SKILLET

CAUTION: Skillet is hot. Handle carefully.

1. Always allow the skillet to completely cool before cleaning.
2. Unplug cord from wall outlet, then remove temperature control probe from appliance (ill. ) using the Temperature Control Release lever. Wipe probe clean with a dry towel (ill. .
3. Immerse the skillet and lid in warm, soapy water and wash with a soft cloth.
4. Rinse well and dry. All parts, except the temperature control probe, are fully immersible and dishwasher-safe.

NOTE: Do Not use steel wool, abrasive cleaners, or metal scouring pads on cooking surfaces as this will damage the non-stick coating.

WARNING: Do not immerse temperature control probe in water or other liquid. Do not overload or over fill skillet (ill. .

HELPFUL HINTS

- Before using the skillet for the first time, lightly brush cooking surface with vegetable oil. Heat, uncovered, to 300°F. Turn "OFF" and cool completely. Wipe away excess oil.
- Use only nylon or heat-proof plastic cooking utensils. Metal utensils may scratch the non-stick surface.
- This skillet is not designed to deep fry. To pan-fry, do not use more than 1 cup of oil. Select a vegetable oil or peanut oil for frying. Butter and olive oil should only be used to saute foods on a lower temperature setting.

TEMPERATURE AND COOKING GUIDE

Food	Amount	Time/Directions	Temp.
BURGERS	1/4 lb	5 to 9 minutes/per side (medium)	350°F - 400°F
STEAK	1" thick, boneless	9 to 12 minutes/per side	350°F - 400°F
CHICKEN	boneless breasts	6 to 7 minutes/per side	350°F - 400°F
FRENCH TOAST		3 to 5 minutes/per side	350°F - 400°F
PANCAKES		1 to 3 minutes/per side	350°F - 400°F
EGGS			
Fried		2 to 3 minutes/first side 1 to 2 minutes/second side Melt 1 to 2 tsp. butter or margarine in skillet.	300°F
Poached	1 to 6 eggs	2 to 3 minutes Pour 2 cups water and 1 tsp. cider vinegar in skillet. Heat to boiling. Break each egg into a bowl; slip into water. Cover and cook 2 to 3 minutes.	250°F or 300°F
Scrambled		3 to 4 minutes Melt 1 to 2 tablespoons butter or margarine in skillet. Add eggs, cook, stir gently, until set and cooked.	300°F
BACON		5 minutes/first side 1 to 3 minutes/second side	350°F - 400°F
SAUSAGE LINKS		8 to 10 minutes	350°F - 400°F
SAUSAGE PATTIES		6 minutes/first side 5 to 6 minutes/second side	350°F - 400°F

CUSTOMER ASSISTANCE

If you have a claim under this warranty, please call our Customer Assistance Number. For faster service, please have the model number and product name ready for the operator to assist you. This number can be found on the bottom of your appliance and on the front page of this manual.

Model Number: _____ **Product Name:** _____

Customer Assistance Number 1.877.207.0923 (U.S.) or 1.877.556.0973 (Canada).

Keep these numbers for future reference!

For more information, please visit us at WWW.GEHOUSEWARES.COM

Two-year limited warranty

What does your warranty cover?

- Any defect in material or workmanship.

For how long after the original purchase?

- Two years.

What will we do?

- Provide you with a new one.
- For those items still under warranty but no longer available, WAL-MART reserves the right to replace with a similar GE branded product of equal or greater value.

How do you make a warranty claim?

- Save your receipt.
- Properly pack your unit. We recommend using the original carton and packing materials.
- Return the product to your nearest WAL-MART store or call Customer Assistance at 1-877-207-0923 (U.S.) or 1-877-556-0973 (Canada).

What does your warranty not cover?

- Parts subject to wear, including, without limitation, glass parts, glass containers, cutter/strainer, blades, seals, gaskets, clutches, motor brushes, and/or agitators, etc.
- Commercial use or any other use not found in printed directions.
- Damage from misuse, abuse, or neglect, including failure to clean product regularly in accordance with manufacturer's instructions.

How does state law relate to this warranty?

- This warranty gives you specific legal rights, and you may also have other rights which vary from state to state or province to province.
- This warranty is in lieu of any other warranty or condition, whether express or implied, written or oral, including, without limitation, any statutory warranty or condition of merchantability or fitness for a particular purpose.
- WAL-MART, GE and the product manufacturer expressly disclaim all responsibility for special, incidental, and consequential damages or losses caused by use of this appliance. Any liability is expressly limited to an amount equal to the purchase price paid whether a claim, however instituted, is based on contract, indemnity, warranty, tort (including negligence), strict liability, or otherwise. Some states or provinces do not allow this exclusion or limitation of incidental or consequential losses, so the foregoing disclaimer may not apply to you.

What if you encounter a problem with this product while using it outside the country of purchase?

- The warranty is valid only in the country of purchase and if you follow the warranty claim procedure as noted.



125599/169170

is a trademark of General Electric Company and is used under the license by Wal-Mart Stores Inc., Bentonville, AR 72716

Marketed in Canada by:

Wal-Mart Canada Corp.
1940 Argentia Road, Mississauga,
Ontario L5N1P9

Printed in China