



**BID80 Series With Built-In Filtration**

**BID80 Series Gas Fryers  
Installation & Operation Manual**

**PARTS LIST  
INCLUDED**



Frymaster, a member of the Commercial Food Equipment Service Association, recommends using CFESA Certified Technicians.

**24-Hour Service Hotline 1-800-551-8633**

**Price: \$10.00**

**819-5896  
APRIL 2002**

**Please read all sections of this manual and retain for future reference.**

**NOTICE**

This appliance is intended for professional use only and is to be operated by qualified personnel only. A Frymaster/Dean Factory Authorized Service Center (FASC) or other qualified professional should perform installation, maintenance, and repairs. Installation, maintenance, or repairs by unqualified personnel may void the manufacturer's warranty. See Chapter 1 of this manual for definitions of qualified personnel.

**NOTICE**

This equipment must be installed in accordance with the appropriate national and local codes of the country and/or region in which the appliance is installed. See NATIONAL CODE REQUIREMENTS in Chapter 3 of this manual for specifics.

**NOTICE**

Drawings and photos used in this manual are intended to illustrate operational, cleaning and technical procedures and may not conform to onsite management operational procedures.

**NOTICE TO OWNERS OF UNITS EQUIPPED WITH COMPUTERS**

**U.S.**

This device complies with Part 15 of the FCC rules. Operation is subject to the following two conditions: 1) This device may not cause harmful interference, and 2) This device must accept any interference received, including interference that may cause undesired operation. While this device is a verified Class A device, it has been shown to meet Class B limits.

**CANADA**

This digital apparatus does not exceed the Class A or B limits for radio noise emissions as set out by the ICES-003 standard of the Canadian Department of Communications.

Cet appareil numérique n'émet pas de bruits radioélectriques dépassant les limites de classe A et B prescrites dans la norme NMB-003 édictée par le Ministre des Communications du Canada.

** DANGER**

Improper installation, adjustment, maintenance or service, and unauthorized alterations or modifications can cause property damage, injury, or death. Read the installation, operating and service instructions thoroughly before installing or servicing this equipment. Only qualified service personnel may convert this appliance to use a gas other than that for which it was originally configured. See Chapter 1 of this manual for definition of qualified service personnel.

**NOTICE**

The Commonwealth of Massachusetts requires any and all gas products to be installed by a licensed plumber or pipe fitter.

 **DANGER**

Adequate means must be provided to limit the movement of this appliance without depending upon the gas line connection. Single fryers equipped with legs must be stabilized by installing anchor straps. All fryers equipped with casters must be stabilized by installing restraining chains. If a flexible gas line is used, an additional restraining cable must be connected at all times when the fryer is in use.

 **DANGER**

The front ledge of the fryer is not a step. Do not stand on the fryer. Serious injury can result from slips or contact with the hot oil.

 **DANGER**

Do not store or use gasoline or other flammable vapors and liquids in the vicinity of this or any other appliance.

 **DANGER**

Instructions to be followed in the event the operator smells gas or otherwise detects a gas leak must be posted in a prominent location. This information can be obtained from the local gas company or gas supplier.

 **DANGER**

The crumb tray in fryers equipped with a filter system must be emptied into a fireproof container at the end of frying operations each day. Some food particles can spontaneously combust if left soaking in certain shortening material. Additional information can be obtained in the filtration manual included with the system.

 **WARNING**

No structural material on the fryer should be altered or removed to accommodate placement of the fryer under a hood. Questions? Call the Frymaster/Dean Service Hotline at 1-800-551-8633.

 **WARNING**

Do not bang fry baskets or other utensils on the fryer's joiner strip. The strip is present to seal the joint between the frypot. Banging fry baskets on the strip to dislodge shortening will distort the strip, adversely affecting its fit. It is designed for a tight fit and should only be removed for cleaning.



**BID80 Series Gas Fryers  
Installation & Operation Manual**

**TABLE OF CONTENTS**

	<b>Page #</b>
<b>1. INTRODUCTION</b> .....	<b>1-1</b>
1.1 After Purchase.....	1-1
1.2 Ordering Parts.....	1-1
1.3 Service Information.....	1-1
1.4 Computer Information.....	1-1
1.5 Safety Information.....	1-2
1.6 Service Personnel.....	1-2
<b>2. IMPORTANT INFORMATION</b> .....	<b>2-1</b>
2.1 Product Description.....	2-1
2.2 Principles of Operation.....	2-1
2.3 Rating Plate.....	2-1
2.4 Pre-Installation.....	2-1
2.5 Air Supply and Ventilation.....	2-3
2.6 Equipment Installed at High Altitudes.....	2-3
2.7 Receiving and Unpacking Equipment.....	2-4
<b>3. INSTALLATION</b> .....	<b>3-1</b>
3.1 Installing the Fryer.....	3-1
3.2 Leveling the Fryer (fryers equipped with legs only).....	3-1
3.3 Installing Casters and Legs.....	3-2
3.4 Gas Categories.....	3-3
3.5 Electrical Connections.....	3-6
<b>4. FRYER OPERATIONS</b> .....	<b>4-1</b>
4.1 Initial Start-up.....	4-1
4.2 Boil-Out Procedure.....	4-2
4.3 Final Preparation.....	4-3



**BID80 Series Gas Fryers  
Installation & Operation Manual**

**TABLE OF CONTENTS (CONT.)**

	Page #
<b>5. BUILT-IN FILTRATION</b> .....	<b>5-1</b>
5.1 General .....	5-2
5.2 Filtration Preparation .....	5-3
5.3 Daily Filtration Operation .....	5-6
5.4 Operating the Filter .....	5-7
<b>6. COMPUTER OPERATION</b> .....	<b>6-1</b>
6.1 Operating Fryers with Computer Magic III.5 Computers .....	6-1
6.2 Programming the Computer Magic III.5 Computer .....	6-4
<b>7. PREVENTATIVE MAINTENANCE</b> .....	<b>7-1</b>
7.1 General .....	7-1
7.2 Daily .....	7-1
7.3 Weekly .....	7-1
7.4 Periodic/Annual .....	7-2
7.5 Stainless Steel .....	7-3
<b>8. TROUBLESHOOTING</b> .....	<b>8-1</b>
8.1 General .....	8-1
8.2 Pilot Burner Malfunction .....	8-1
8.3 Main Burner Malfunctions .....	8-2
8.4 Wiring Diagrams .....	8-4
<b>9. PARTS LIST</b> .....	<b>9-1</b>
9.1 Accessories .....	9-1
9.2 Cabinetry and Related Components .....	9-2
9.3 Computer and Related Components .....	9-4
9.4 Drain Valve Components .....	9-6
9.5 Filter Pan Components .....	9-7
9.6 Frypot, Burners and Related Components .....	9-8
9.7 Oil Return Components .....	9-10

# BID80 SERIES GAS FRYERS

## CHAPTER 1: INTRODUCTION

---

### 1.1 After Purchase

In order to improve service, have the following chart filled in by the Frymaster Authorized Service Technician who installed this equipment.

Authorized Service Technician/FASC	_____
Address	_____
	_____
Telephone/Fax	_____
Model Number	_____
Serial Number	_____
Gas Type	_____

### 1.2 Ordering Parts

Customers may order parts directly from their local factory authorized service center. For this address and phone number, contact your factory authorized service center or call the Frymaster Service Hotline phone number, 1-800-551-8633.

To speed up your order, provide the model number, serial number, gas type, part needed, item part number (if known), and quantity needed.

### 1.3 Service Information

Call the Frymaster Service Hotline, 1-800-551-8633, for the location of your nearest factory authorized service center. To assist you more efficiently, always provide the service technician with the model number, gas type, serial number, and the nature of the problem.

### 1.4 Computer Information

This equipment has been tested and found to comply with the limits for a Class A digital device, pursuant to Part 15 of the FCC rules. While this device is a verified Class A device, it has been shown to meet the Class B limits. These limits are designed to provide reasonable protection against harmful interference when the equipment is operated in a commercial environment. This equipment generates, uses and can radiate radio frequency energy and, if not installed and used in accordance with the instruction manual, may cause harmful interference to radio communications. Operation of the equipment in a residential area is likely to cause harmful interference in which case the user will be required to correct the interference at his own expense.

# BID80 SERIES GAS FRYERS

## CHAPTER 1: INTRODUCTION

---

### 1.4 Computer Information (cont.)

The user is cautioned that any changes or modifications not expressly approved by the party responsible for compliance could void the user's authority to operate the equipment.

If necessary, the user should consult the dealer or an experienced radio and television technician for additional suggestions.

The user may find the following booklet prepared by the Federal Communications Commission helpful: "How to Identify and Resolve Radio-TV Interference Problems". This booklet is available from the U.S. Government Printing Office, Washington, DC 20402, Stock No. 004-000-00345-4.

### 1.5 Safety Information

Before attempting to operate your unit, read the instructions in this manual thoroughly.

Throughout this manual, you will find notations enclosed in double-bordered boxes similar to the ones below.

#### CAUTION

**CAUTION** boxes contain information about actions or conditions that *may cause or result in a malfunction of your system.*

#### WARNING

**WARNING** boxes contain information about actions or conditions that *may cause or result in damage to your system*, and which may cause your system to malfunction.

#### DANGER

**DANGER** boxes contain information about actions or conditions that *may cause or result in injury to personnel*, and which may cause damage to your system and/or cause your system to malfunction.

### 1.6 Service Personnel

#### 1.6.1 Definitions

##### A. Qualified and/or Authorized Operating Personnel

1. Qualified/authorized operating personnel are those who have carefully read the information in this manual and have familiarized themselves with the equipment functions, or have had previous experience with the operation of equipment covered in this manual.

**BID80 SERIES GAS FRYERS  
CHAPTER 1: INTRODUCTION**

---

**1.6.1 Definitions (cont.)**

**B. Qualified Installation Personnel**

1. Qualified/authorized personnel are those who have carefully read the information in this manual and have familiarized themselves with the equipment functions, or who have had previous experience with the operation of the equipment covered in this manual.

**C. Qualified Service Personnel**

1. Qualified service personnel are those who are familiar with Frymaster equipment and have been authorized by Frymaster to perform service on Frymaster equipment. All authorized service personnel are required to be equipped with a complete set of service parts manuals and stock a minimum amount of parts for Frymaster equipment. A list of Frymaster Factory Authorized Service Centers (FASCs) was included with the fryer when shipped from the factory. *Failure to use qualified service personnel will void the Frymaster warranty on your equipment.*



# BID80 SERIES GAS FRYERS

## CHAPTER 2: IMPORTANT INFORMATION

---

### 2.1 Product Description

Frymaster BID80 Series gas fryers are energy-efficient, tube-style, gas-fired units, design-certified by the International Approval Services (AGA/CGA), National Sanitation Foundation (NSF), and manufactured to their basic performance and application specifications.

All units are shipped completely assembled with accessories packed inside the frypot. All units are adjusted, tested and inspected at the factory before shipment. Sizes, weights and input rates of all models are listed in this manual.

**NOTE:** The on-site supervisor is responsible for ensuring that operators are made aware of inherent dangers of operating a deep fat fryer, particularly aspects of oil filtration, draining, and cleaning of the fryer.

### 2.2 Principles of Operation

The incoming gas flows through orifices and is mixed with air in the burners to create the correct ratio for proper combustion. The mixture is ignited at the front end of each heat tube by the pilot light. Internal diffusers slow the flame as it goes through the burner tube. This slower and more turbulent flame gives much better heat transfer to the walls of the tubes, thereby heating the oil better.

### 2.3 Rating Plate

This is attached to the inside right-hand corner of the front door panel. Information provided includes the model and serial number of the fryer, BTU/hr input of the burners, outlet gas pressure in inches W.C. (mbars) and whether the unit has natural or propane gas orifices.



**Fryers MUST be connected ONLY to the gas type identified on the attached rating plate.**

### 2.4 Pre-Installation

A. **General:** Only a licensed gas fitter should install any gas-fired equipment.

1. A manual gas shut-off valve must be installed in the gas supply line ahead of the fryers for safety and ease of future service.

**BID80 SERIES GAS FRYERS  
CHAPTER 2: IMPORTANT INFORMATION**

---

**2.4 Pre-Installation (cont.)**

2. Frymaster BID80 Series gas fryers require 120VAC 60 cycle or 230VAC single-phase 50-hertz (International/CE) electrical service and are equipped with a 16-3 SJT grounded flexible power cord for a direct connection to the power supply. Amperage draw for each unit depends on the accessories supplied with the unit/system.
- B. Clearances:** The fryer area must be kept free and clear of all combustibles. This unit is design-certified for the following installations:
1. Commercial installation only (not for household use).
  2. Non-combustible floor installation equipped with factory-supplied 6-inch (15-cm) adjustable legs or 5-inch (13-cm) casters;
  3. Combustible construction with a minimum clearance of 6-inches (15-cm) side and 6-inches (15-cm) rear, and equipped with factory-supplied 6-inch (15-cm) adjustable legs or 5-inch (13-cm) casters.



**Local building codes usually prohibit a fryer with its open tank of hot oil from being installed beside an open flame of any type, whether a broiler or the open burner of a range.**

**C. Installation Standards:**

<p>1. <u>U.S. installations must meet:</u></p> <p>American National Standard Institute ANSI Z83.11 American Gas Association 8501 E. Pleasant Valley Road Cleveland, OH 44131</p> <p>National Electrical Code ANSI/NFPA #70 American National Standard Institute 1430 Broadway New York, NY 10018</p> <p>NFPA Standards #96 and #211 National Fire Protection Association 470 Atlantic Avenue Boston, MA 02110</p>	<p>2. <u>Canadian installations must meet:</u></p> <p>CAN 1-B149 Installation Codes Canadian Gas Association 55 Scarsdale Road Don Mills, ONT, M3B 2R3</p> <p>Canadian Electric Code c22.1, part 1 Canadian Standards Association 178 Rexdale Blvd. Rexdale, ONT, M9W 1R3</p>
---	---

**BID80 SERIES GAS FRYERS**  
**CHAPTER 2: IMPORTANT INFORMATION**

---

## **2.4 Pre-Installation (cont.)**

3. CE/EXPORT STANDARDS: Fryer installation must conform with local codes, or in the absence of local codes, to the appropriate national or European Community (CE) standards.

## **2.5 Air Supply and Ventilation**

Keep the area around the fryer clear to prevent obstruction of combustion and ventilation airflow as well as for service and maintenance.

- A. Do not connect this fryer to an exhaust duct.
- B. Correct installation and adjustment will ensure adequate airflow to the fryer system.
- C. A commercial, heavy-duty fryer must vent its combustion wastes to the outside of the building. A deep-fat fryer must be installed under a powered exhaust hood, or an exhaust fan must be provided in the wall above the unit, as exhaust gas temperatures are approximately 800-1000°F (427-538°C). Check air movement during installation. Strong exhaust fans in the exhaust hood or in the overall air conditioning system can produce slight air drafts in the room.
- D. Do not place the fryer's flue outlet directly into the plenum of the hood, as it will affect the gas combustion of the fryer.
- E. Never use the interior of the fryer cabinet for storage or store items on shelving over or behind the fryer. Exhaust temperatures can exceed 425°C and may damage or melt items stored in or near the fryer.
- F. Adequate distance must be maintained from the flue outlet of the fryer(s) to the lower edge of the filter bank. Per NFPA Standards No. 96, a minimum of 18-inches (45-cm) should be maintained between the flue(s) and the lower edge of the exhaust hood filter.
- G. Filters and drip troughs should be part of any industrial hood, but consult local codes before constructing and installing any hood. The duct system, the exhaust hood and the filter bank must be cleaned on a regular basis and kept free of grease.

## **2.6 Equipment Installed at High Altitudes**

- A. The fryer input rating (BTU/hr) is for elevations up to 2,000 feet (610-m). For elevations above 2,000 feet (610-m), the rating should be reduced four percent for each additional 1,000 feet (305-m) above sea level.
- B. The correct orifices are installed at the factory if operating altitude is known at time of the customer's order.

**BID80 SERIES GAS FRYERS**  
**CHAPTER 2: IMPORTANT INFORMATION**

---

## **2.7 Receiving and Unpacking Equipment**

- A. Check that the container is upright. Use an outward prying motion - *no hammering* - to remove the carton. Unpack the fryer carefully and remove all accessories from the carton. Do not discard or misplace these, as they will be needed.
- B. After unpacking, immediately check the equipment for visible signs of shipping damage. If damage has occurred, contact the carrier and file the appropriate freight claims. Do not contact the factory. Shipping damage responsibility is between the carrier and the dealer.

**If your equipment arrives damaged:**

- 1. File claim for damages immediately, regardless of extent of damage.
- 2. Visible loss or damage: Be sure this is noted on the freight bill or express receipt and is signed by the person making the delivery.
- 3. Concealed loss or damage: If damage is unnoticed until equipment is unpacked, notify freight company or carrier immediately, and file a concealed damage claim. This should be done within 15 days of date of delivery. Be sure to retain container and all packing materials for inspection.

**NOTE: Frymaster Does Not Assume Responsibility for Damage or Loss Incurred in Transit.**

- C. Remove all plastic skin from sides, front, and doors of the fryer(s). Failure to do this prior to initial fryer operation will make it very difficult to remove later.

# BID80 SERIES GAS FRYERS

## CHAPTER 3: INSTALLATION

---

### 3.1 Installing the Fryer

- A. Initial Installation: If the fryer is installed with legs, do not push the fryer to adjust its position. Use a pallet or lift jack to lift the fryer slightly, then place the fryer where it is to be installed.
- B. Relocating the fryer: Remove all weight from each leg before moving a fryer with legs installed. Do not slide the fryer on the legs.
- C. If a leg becomes damaged, contact your service agent for immediate repair/replacement.

### 3.2 Leveling the Fryer (fryers equipped with legs only)

- A. **All Installations**: If the floor is uneven or has a definite slope, it is recommended to place the fryer on an even platform.
- B. Place a spirit level across the top of the fryer and level the unit both front-to-back and side-to-side. If it is not level, the unit may not function efficiently, the oil may not drain properly for filtering and in a line-up it may not match adjacent units.
- C. Adjust to the high corner and measure with the spirit level. If floor is uneven, level the unit with the screw adjustments on each leg (**ensure minimum clearances as discussed in Chapter 2 are maintained during the leveling procedure**).
- D. **Re-leveling**: If the fryer is moved, re-level the fryer following the above instructions.
- E. The install must be reviewed at the time of installation to ensure it meets the intent of these instructions.

 **CAUTION**

**Fryers must be at room temperature, empty of oil, and if fitted with legs, lifted during movement to avoid damage and possible bodily injury.**

 **DANGER**

**Hot shortening can cause severe burns. Avoid contact. Under all circumstances, oil must be removed from the fryer before attempting to move it to avoid oil spills, and the falls and severe burns that could occur. This fryer may tip and cause personal injury if not secured in a stationary position.**

# BID80 SERIES GAS FRYERS

## CHAPTER 3: INSTALLATION

### 3.3 Installing Casters and Legs

- A. Install casters and/or legs near where the fryer is to be used, as neither is secure for long transit. BID80 Series gas fryers cannot be curb mounted and must be equipped with either legs or casters provided.
- B. After unpacking, use a pallet or lift jack to raise the unit before installing the casters.
- C. Align the caster or leg base holes with the leg support assembly and insert bolt. Install the washers and nut hand tight, and repeat for all four holes in caster/leg base assembly.
- D. Tighten the caster/leg against the leg support assembly by using appropriate tools. Ensure that all four bolts are evenly tightened.
- E. **For fryers with casters, there are no built-in leveling devices.** The floor where the fryers are installed must be level.

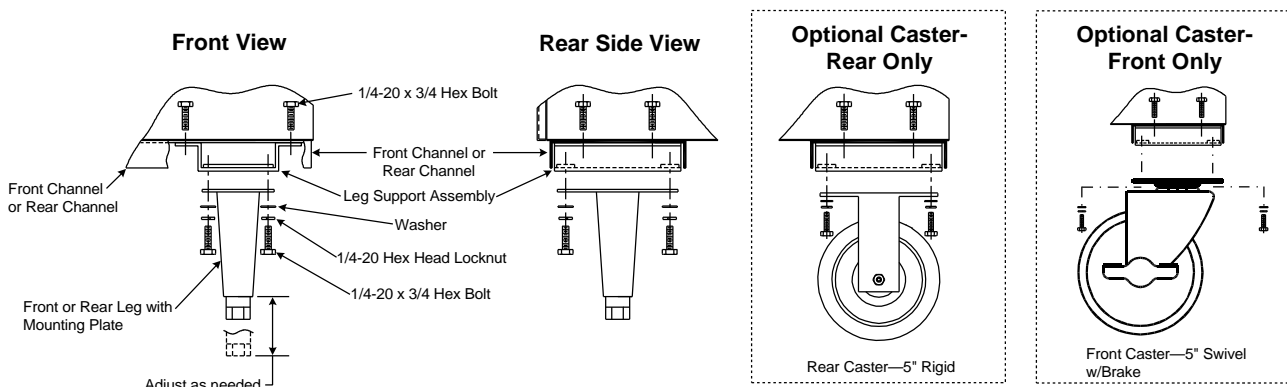

**Caster/Leg Installation and Adjustment**

**⚠ WARNING**

**Frymaster fryers equipped with legs are for permanent installations. Fryers fitted with legs must be lifted during movement to avoid damage and possible bodily injury. For a moveable or portable installation, Frymaster optional equipment casters must be used.**

**Questions? Call 1-800-551-8633**

**BID80 SERIES GAS FRYERS  
CHAPTER 3: INSTALLATION**

### 3.4 Gas Connections

 **DANGER**

**Before connecting new pipe to this appliance the pipe must be blown out thoroughly to remove all foreign material. Foreign material in the burner and gas controls will cause improper and dangerous operation.**

#### NATIONAL CODE REQUIREMENTS

This equipment is to be installed in compliance with the Basic Plumbing Code of the Building Officials and Code Administrators International, Inc. (BOCA) and the Food Service Sanitation Manual of the U.S. Food and Drug Administration.

This equipment is manufactured to use the type of gas specified on the rating plate attached to the door. Connect equipment stamped "NAT" only to natural gas and that stamped "PRO" only to LP (Propane) gas.

**Installation shall be made with a gas connector that complies with national and local codes. Quick disconnect devices, if used, shall likewise comply with national and local codes.**

 **DANGER**

**The fryer MUST be connected to the gas supply specified on the rating and serial number plate located on the back of the fryer door.**

 **DANGER**

**If gas odors are detected, the gas supply MUST be shut off at the main shut-off valve. The local gas company or FASC should be contacted immediately to rectify the problem.**

- A. The gas supply (service) line must be the same size or greater than the fryer inlet line. This fryer is equipped with a 3/4" (19 mm) male inlet. The gas supply line must be sized to accommodate all the gas-fired equipment that may be connected to that gas supply. Consult your contractor, gas company, supplier, or other knowledgeable authorities.

<b>Recommended Gas Supply Line Sizes</b>			
<b>Gas Types</b>	<b>Number of Fryers</b>		
	1	2 to 3	4 or more (*)
Natural Gas	3/4" (19 mm)	1" (25 mm)	1 1/4" (33 mm)
Propane Gas	1/2" (13 mm)	3/4" (19 mm)	1" (25 mm)
(*) When exceeding 18 feet (6 meters) for a configuration of more than four fryers, it is necessary to provide a 1 1/4" (33 mm) rigid gas connection.			

**BID80 SERIES GAS FRYERS  
CHAPTER 3: INSTALLATION**

---

### 3.4 Gas Connections (cont.)

 **DANGER**

**All connections must be sealed with a joint compound suitable for the gas being used and all connections must be tested with a solution of soapy water before lighting any pilots.**

**Never use matches, candles, or any other ignition source to check for leaks. If gas odors are detected, shut off the gas supply to the appliance at the main shut-off valve and immediately contact the local gas company or an authorized service agency for service.**

 **DANGER**

**"Dry-firing" your unit will cause damage to the frypot and can cause a fire. Always ensure that melted shortening, cooking oil or water is in the frypot before firing the unit.**

- B. Rigid Connections: Check any installer-supplied intake pipe(s) visually and clean threading chips, or any other foreign matter before installing into a service line. If the intake pipes are not clear of all foreign matter, the orifices will clog when gas pressure is applied. Seal pipe joints with a sealant resistive to LP gas. When using thread compound on gas piping, use very small amounts and only on male threads. Use a pipe thread compound that is not affected by the chemical action of LP gases. **DO NOT** apply thread compound to the first two pipe threads—doing so will cause clogging of the burner orifices and control valve.
- C. Manual shut-off valve: This gas service supplier-installed valve must be installed in the gas service line ahead of the fryers in the gas stream and in a position where it can be reached quickly in the event of an emergency.
- D. Regulating Gas Pressure: The fryer and shut-off valve must be disconnected from the gas supply during any pressure testing of the system.
  - 1. External gas regulators are not normally required on this fryer. A safety control valve protects the fryer against pressure fluctuations. If the incoming pressure is in excess of ½" PSI (3.45 kPa/35 mbar), **a step-down regulator will be required.**

 **DANGER**

**When pressure-testing incoming gas supply lines, disconnect the fryer from the gas line if the test pressure is ½" PSI [3.45 kPa (14 inches W.C.)] or greater to avoid damage to the fryer's gas piping and gas valve(s).**



## BID80 SERIES GAS FRYERS

### CHAPTER 3: INSTALLATION

---

#### 3.4 Gas Connections (cont.)

- E. Manifold Pressure: Only qualified personnel should check the manifold pressure with a manometer.
1. Check the rating plate for manifold gas pressures. Natural gas units normally require 4" W.C., and propane units normally require 11" W.C. gas pressure.
  2. Double check the arrow forged into the bottom of the regulator body, which shows gas flow direction. It should point downstream towards the fryers. The air vent cap is also part of the regulator and should not be removed.
  3. If a vent line from the gas pressure regulator is used, it should be installed in accordance with local codes or in the absence of local codes, with the National Fuel Gas Code, ANSI Z223.1-(latest edition).

 **WARNING**

**Use a diluted soap solution to find potentially dangerous gas leaks when making new connections.**

- F. Regulators can be adjusted in the field, but it is recommended that they not be tampered with unless the part is known to be out of adjustment or serious pressure fluctuations are found to exist and can be solved no other way.
- G. Only qualified service personnel should make adjustments to the regulators.
- H. Orifices: The fryer can be configured to operate on any available gas. The correct safety control valve, appropriate gas orifices, and pilot burner are installed at the factory. While the valve can be adjusted in the field, only qualified service personnel should make any adjustments with the proper test equipment.
- I. Flexible Couplings, Connectors and Casters:
1. If the fryer is to be installed with flexible couplings and/or quick-disconnect fittings, the installer must use a heavy-duty AGA design-certified commercial flexible connector of at least 3/4" NPT (with suitable strain reliefs), in compliance with the Standard for Connectors for Movable Gas Appliances, ANSI Z21.69-(latest edition) and Addenda Z21.69a-(latest edition). Quick disconnect devices must comply with the Standard for Quick-Disconnect Devices for Use with Gas Fuel, ANSI Z21.41-(latest edition).

 **WARNING**

**Do not attach accessories to this fryer unless fryer is secured from tipping. Personal injury may result.**

2. The fryer must be restrained by means independent of the flexible coupling or connector in order to limit the movement of the fryer. Clips are located on the back panel of the fryer for the attachment of restraints.

## BID80 SERIES GAS FRYERS CHAPTER 3: INSTALLATION

---

### 3.4 Gas Connections (cont.)

3. If disconnection of the restraint is necessary, this restraint must be reconnected after the fryer has been returned to its originally installed position.
- J. After hook-up, bleed the gas line of air to ensure that the pilot light will ignite quickly.
- K. CE Standards: If the unit is to be installed with flexible coupling, use a commercial flexible coupling certified as NF D 36123 (or other national standard) or a quick disconnect device certified NF D 36124 (or other national standard).

### 3.5 Electrical Connections

The fryer when installed must be electrically grounded in accordance with local codes, or in the absence of local codes, with the National Electrical Code, ANSI/NFPA 70-(latest edition).

 **DANGER**

**This fryer is equipped with a three-prong (grounding) plug for protection against electrical shock and must be plugged directly into a properly grounded, three-prong receptacle. DO NOT CUT, REMOVE, OR OTHERWISE BYPASS THE GROUNDING PRONG ON THIS PLUG!**

The rating plate and wiring diagram are located inside the front door. The fryer is equipped with a 120VAC single-phase 60-hertz system (Domestic), or 230VAC single-phase 50-hertz system (International/CE). Do not cut or remove the ground prong from the power cord plug. Do not attempt to use the fryer during a power outage.

 **DANGER**

**This appliance requires electrical power for operation. Place the gas control valve in the OFF position in case of a prolonged power outage. Do not attempt to operate this appliance during a power outage.**

# BID80 SERIES GAS FRYERS

## CHAPTER 4: FRYER OPERATIONS

---

### 4.1 Initial Start-up

 **WARNING**

The on-site supervisor is responsible for ensuring that operators are made aware of the inherent hazards of operating a hot oil frying system, particularly the aspects of system operation, oil filtration, draining and cleaning procedures.

- A. Cleaning: New units are wiped clean with solvents at the factory to remove any visible signs of dirt, oil, grease, etc. remaining from the manufacturing process, then coated lightly with oil. Before any food preparation, wash thoroughly with hot, soapy water to remove any film residue and dust or debris then rinse out and wipe dry. Also wash any accessories shipped with the unit. Close the drain valve completely and remove the crumb screen covering the heating tubes. Ensure the screws holding the thermostat and high-limit control sensing bulbs into the frypot are tight.

 **WARNING**

Do not bang fry baskets or other utensils on the fryer's joiner strip. The strip is present to seal the joint between the frypots. Banging fry baskets on the strip to dislodge shortening will distort the strip, adversely affecting its fit. It is designed for a tight fit and should only be removed for cleaning.

 **DANGER**

Never operate this appliance with an empty frypot. The frypot must be filled with water or cooking oil/shortening before lighting the burners. Failure to do so will damage the frypot and may cause a fire.

 **WARNING**

When checking for burner ignition or performance, do not get too close to the burners. Slow ignition can cause possible flashback, increasing the potential for facial and body burns.

#### 4.1.1 Pilot Lighting Procedures, Electronic Ignition Systems

 **WARNING**

Never use a match or taper to light pilot on this ignition system.

1. Turn gas "ON".
2. Turn electric power "ON" with the appropriate rocker switch or controller/computer.

**BID80 SERIES GAS FRYERS  
CHAPTER 4: FRYER OPERATIONS**

---

**4.1.1 Pilot Lighting Procedures, Electronic Ignition Systems (cont.)**

3. The electric module will turn on the pilot gas supply and the electric ignition spark. The spark will ignite the pilot gas. The presence of the pilot flame is then proved by the electric flame sensor, which in turn allows the main gas supply to be turned on. The operating thermostat or computer/controller controls the fryer after ignition.

 **WARNING**

**In the event of prolonged power failure, the ignition module will shut down and lock out the system. Turn the unit power "OFF" and them back "ON" after power has been re-established.**

4. If the pilot flame fails, the ignition module will shut down and lock out the system. To restart, turn the electric power "OFF", wait approximately 5 minutes for the system to recycle itself, then turn the power "ON" again. Repeat Steps 1-3.

**4.2 Boil-Out Procedure**

 **DANGER**

**Never leave the fryer unattended during the boil-out process. If the boil-out solution boils over, turn the fryer off immediately and let the solution cool for a few minutes before resuming the process. To lessen the chance of boil over, turn the fryer's gas valve knob to the PILOT position occasionally.**

 **WARNING**

**Do not drain boil-out solution into a shortening disposal unit, a built-in filtration unit, or a portable filter unit. These units are not intended for this purpose, and will be damaged by the solution.**

 **DANGER**







**Remove all drops of water from the frypot before filling with cooking oil or shortening. Failure to do so will cause spattering of hot liquid when the oil or shortening is heated to cooking temperature and may cause injury to nearby personnel.**

- A. Before switching the fryer(s) "ON", close the frypot drain valve(s). Fill the empty frypot with a mixture of cold water and boil-out solution. Follow instructions when mixing.
- B. To program computer for Boil Feature, press either  switch.

**BID80 SERIES GAS FRYERS**  
**CHAPTER 4: FRYER OPERATIONS**

---

## 4.2 Boil-Out Procedure (cont.)

- C. Press the  switch. **Code** will appear in the left display.
- D. Enter     (1 6 5 3) in that sequence. The right display will read **Boil**. The temperature is automatically set for 195°F (91°C). The fryer will attain this temperature and remain there until either  switch is pressed, which cancels the boil-out mode. In high-altitude locations, constantly monitor the fryer for over boil. If over-boil occurs, turn off fryer immediately, allow to cool, and re-enter boil-out mode to continue the boil-out operation.
- E. The burners will heat the boil-out solution to a simmer. Simmer the solution for approximately 45 minutes. Wearing protective gloves, scrub the sides of the frypot and the tubes with the L-shaped Teflon brush, being careful not to disturb the temperature sensing probes and the high-limit thermostat.
- F. Do not allow the water level to decrease below the bottom OIL LEVEL line in frypot during boil-out operation.
- G. After boil out is complete, press the  switch to turn fryer off, and then drain the solution from the frypot. Place a metal pan or bucket under the drain port to collect the water from the frypot. **DO NOT ALLOW BOIL-OUT SOLUTION TO DRAIN INTO FILTER PAN!**
- H. Close the drain, add fresh water (without boil-out solution) and wash all surfaces of the frypot. Drain again.
- I. Refill the frypot with fresh water and vinegar to neutralize any residual boil-out solution. Wash all surfaces of the frypot. Drain completely and wipe down all surfaces of the frypot to completely eliminate water from the frypot.

## 4.3 Final Preparation

 **WARNING**

**Do not go near the area directly over the flue outlet while the fryer is operating.**

**Always wear oil-proof, insulated gloves when working with the fryer filled with hot oil.**

**Always drain hot oil into a metal container. Hot oil can melt plastic buckets and crack glass containers.**

**BID80 SERIES GAS FRYERS**  
**CHAPTER 4: FRYER OPERATIONS**

---

### 4.3 Final Preparation (cont.)

 **WARNING**

**NEVER set a complete block of solid shortening on top of the heating tubes. To do so will damage the heating tubes and frypot, and void the warranty.**

- A. When using a liquid shortening (cooking oil), fill the fryer to the bottom OIL LEVEL line scribed into the back of the frypot.
- B. When using a solid shortening, first melt it in a suitable container, or cut it into small pieces and pack it below the heat tubes, between the tubes and on top of the tubes, leaving no air spaces around the tubes. Do not disturb or bend the sensing bulbs. **Never set a complete block of solid shortening on top of the heating tubes. To do so will damage the heating tubes and frypot, and void the warranty.**
- C. Press the  switch to turn fryer on. The burners will initially operate in the MELT CYCLE mode until the shortening reaches 180°F (82°C). It will then automatically switch to normal operation.
- D. When the frypot is filled and the shortening is melted, carefully replace the frypot crumb screen over the heat tubes. Wear oil-proof insulated gloves to avoid the potential for burn injury when replacing crumb screen.
- E. Before starting operation, program the computer to the probable working temperature and wait for the temperature to stabilize.

# BID80 SERIES GAS FRYERS

## CHAPTER 5: BUILT-IN FILTRATION

---

 **WARNING**

Drawings and photos used in this manual are intended to illustrate operational, cleaning and technical procedures and may not conform to on-site management operational procedures.

 **WARNING**

The on-site supervisor is responsible for ensuring that operators are made aware of the inherent hazards of operating a hot oil filtration system, particularly the aspects of oil filtration, draining and cleaning procedures.

 **WARNING**

When operating the filtration system, never leave the filter unattended. The action of the oil moving through the hose lines could jolt a flexible return hose (where applicable) out of the filter pan, spraying hot oil and causing severe burns.

 **DANGER**

The crumb tray in fryers equipped with a filter system must be emptied into a fireproof container at the end of frying operations each day. Some food particles can spontaneously combust if left soaking in certain shortening material.

**IMPORTANT**

Cooking oil/shortening should be filtered at least daily, or more frequently if cooking is heavy. This assures the longest life possible for the oil and minimizes flavor transfer.

## BID80 SERIES GAS FRYERS CHAPTER 5: BUILT-IN FILTRATION

---

### 5.1 General

Frymaster BID80 Series fryers come equipped with a built-in filtration system. Photos used in the procedural illustrations may differ slightly from the filter unit that came with the frying system. The following procedures apply to all BID80 Series fryers equipped with built-in filter systems.



Typical built-in filter installed in a single fryer unit.



# BID80 SERIES GAS FRYERS

## CHAPTER 5: BUILT-IN FILTRATION

### 5.2 Filtration Preparation

On initial installation and before each use, remove all loose parts from the filter, wash the filter pan and all accessories in hot, soapy water and dry thoroughly.

#### 5.2.1 Assembling the Filter

The BID80 Series filter system uses filter paper held in place by a hold-down ring to filter impurities and debris from the cooking medium. The filter pan is assembled with the following components (see illustration below):

1. Filter pan.
2. Filter support grid.
3. Filter paper.
4. Hold-down ring.
5. Crumb screen.
6. Rear pan cover.
7. Front pan cover.

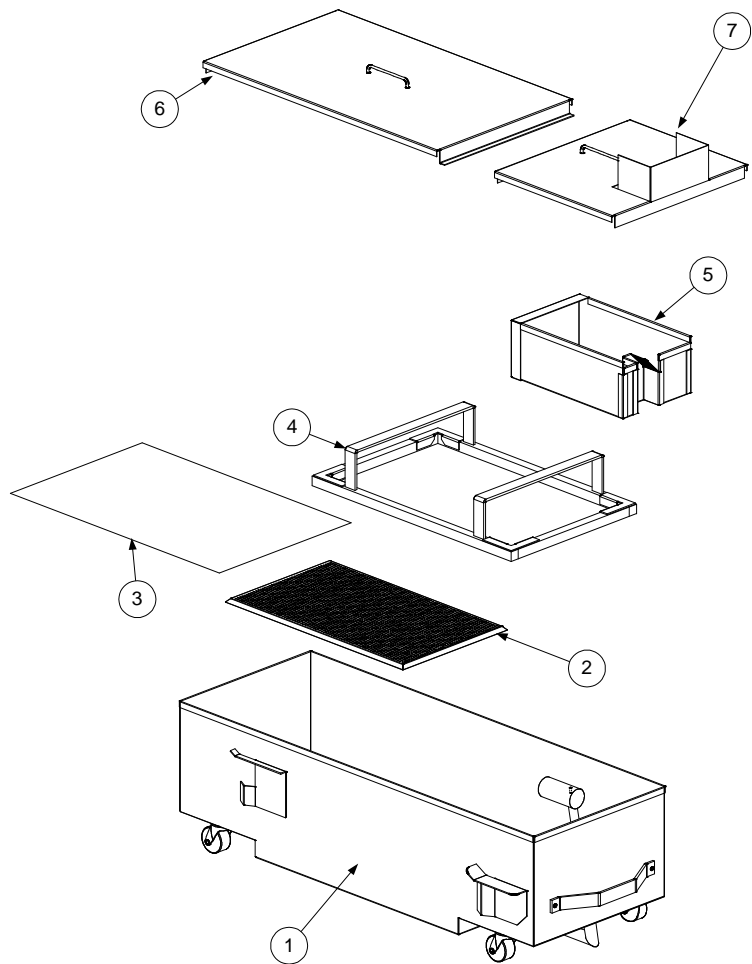

## BID80 SERIES GAS FRYERS CHAPTER 5: BUILT-IN FILTRATION

---

### 5.2.1 Assembling the Filter (cont.)

Assemble the filter as follows:

1. Place the support grid in the bottom of filter pan.



Support grid properly placed in filter pan.

2. Put one filter paper sheet on top of the support grid. Be sure the paper covers the filter pan bottom and laps two inches onto the pan wall.



Ensure filter paper overlaps two inches on all sides and is evenly distributed under the hold-down ring.

3. Position the hold-down ring on top of the filter paper. Ensure the hold-down ring seals around the support grid. This prevents air from getting into the system.



Hold-down ring positioned correctly over filter paper in filter pan.

## BID80 SERIES GAS FRYERS CHAPTER 5: BUILT-IN FILTRATION

---

### 5.2.1 Assembling the Filter (cont.)

4. Sprinkle 8 ounces of filter powder on the filter sheet. Ensure the powder covers the filter paper evenly.



Sprinkle the proper amount of filter powder evenly over the paper.

5. Place the crumb screen in the filter pan. Allow the crumb screen to rest on the top edges of the hold-down ring.



Crumb screen properly placed.

6. Place filter pan covers (2) onto the filter pan assembly. Ensure the front cover is correctly positioned over the slip fitting.



Fully assembled pan with proper placement of lid over slip fitting.

## BID80 SERIES GAS FRYERS CHAPTER 5: BUILT-IN FILTRATION

### 5.2.2 Installing the Filter

Slide the filter inside the fryer cabinet. Ensure the male-female slip-fitting coupling is fully engaged.

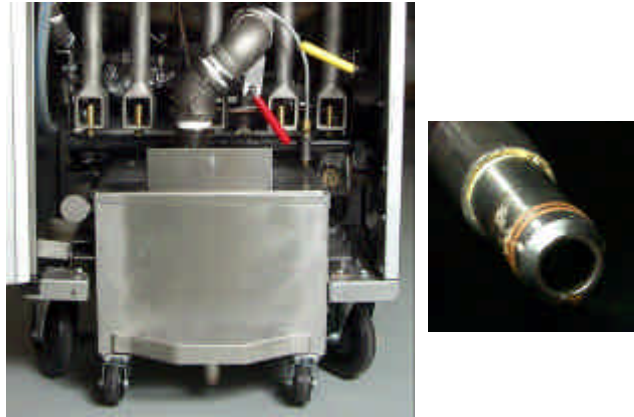

The filter pan slides under the fryer (left), connecting with a slip fitting (right). Slip fitting location will vary (above or to the side of the filter pan), according to fryer system.

### 5.3 Daily Filtration Operation

#### DANGER

Use caution and wear proper protective clothing. The oil to be filtered is at or near 350°F (177°C). Ensure all hoses are connected properly and drain handles are in their proper position prior to operating any switches or valves. Failure to do this can result in severe burns.

#### NOTICE

Drawings and photos used in this manual are intended to illustrate operational, cleaning and technical procedures and may not conform to on-site management operational procedures.

#### 5.3.1 General Overview

The filter pump is turned on only after the shortening/oil is brought to operating temperature and drained into the prepared filter pan. The filter motor is then engaged and oil is drawn through filter paper and pumped back into the frypot. The frypot's drain remains open during the filtering process. Allow the oil to cycle through the filter paper for approximately 5 minutes. At the end of 5 minutes, close the drain valve and allow the pump to fill the frypot to the top OIL LEVEL line. Leave the pump running for 10-15 seconds after bubbles appear in the frypot to ensure all shortening/oil is pumped from the drain pan and the lines.

## BID80 SERIES GAS FRYERS CHAPTER 5: BUILT-IN FILTRATION

---

### 5.3.2 Filtering Tools

Assemble tools to be used for filtering. These are supplied with the filter starter kit included with the fryer/filter system:

- Frypot/Filter Brush - used to clean frypot and filter pan sides and bottom, heating elements, and to dislodge sediment during filtration or shortening/oil change.
- Clean-Out Rod (design may vary)- used to dislodge heavy debris in the drain tube (when needed).
- Filter Powder.
- Filter Paper.

The following tools are not required, but are recommended to make the filtering task easier.

- Measuring Cup - used to measure filter powder.
- Stainless Steel Crumb Scoop – for removing large debris from shortening/oil prior to filtering.

Note: Always wear oil-resistant, insulated gloves and/or protective gear when working with hot oil.

### 5.4 Operating the Filter

 **DANGER**

**Draining and filtering of cooking oil or shortening must be accomplished with care to avoid the possibility of a serious burn caused by careless handling. The oil to be filtered is at or near 350°C (177°C). Ensure all hoses are connected properly and drain handles are in their proper position before operating any switches or valves. Wear all appropriate safety equipment when draining and filtering cooking oil or shortening.**

 **DANGER**

**Allow oil/shortening to cool to 100°F (38°C) before draining into an appropriate container for disposal.**

**BID80 SERIES GAS FRYERS  
CHAPTER 5: BUILT-IN FILTRATION**

---

## 5.4 Operating the Filter (cont.)

 **DANGER**

**Do not drain more than one frypot at a time into the built-in filtration unit to avoid overflow and spillage of hot oil/shortening.**

 **DANGER**

**When draining oil/shortening into a disposal unit or portable filter unit, do not fill above the maximum fill line located on the container.**

 **DANGER**

**NEVER attempt to drain cooking oil or shortening from the fryer with the burner lit! Doing so will result in a flash fire if the oil or shortening splashes onto the burner. Also, applying burner heat to an empty frypot will severely damage the frypot and void all applicable warranties**

 **DANGER**

**NEVER attempt to clear a clogged drain valve from the front of the valve! Hot oil or shortening will rush out creating the potential for severe burns.**

**DO NOT hammer on the drain valve with the cleanout rod or other objects. Damage to the ball inside will result in leaks and will void all applicable warranties.**

### 5.4.1 Pan Preparation

See Section 5.2.1– Assembling the Filter, and Section 5.2.2– Installing the Filter

## BID80 SERIES GAS FRYERS CHAPTER 5: BUILT-IN FILTRATION

### 5.4.2 Filter Operation

**⚠ CAUTION**

**NEVER operate the filter unit unless cooking oil/shortening is at operating temperature [ $\sim 350^{\circ}\text{F}$  ( $\sim 177^{\circ}\text{C}$ )].**

1. Turn the fryer off. Ensure the filter pan assembly is prepared as described in Section 5.2.1—Assembling the Filter.
2. Remove fry baskets from frypot. Prior to filtering, skim any large debris from the shortening/oil. Use extreme caution, as shortening/oil is at or near operating temperature [ $\sim 350^{\circ}\text{F}$  ( $\sim 177^{\circ}\text{C}$ )].



Prior to filtering, skim any large debris from oil in frypot.

3. Remove the support grid from the frypot using the clean-out rod. Stir the oil with the L-shaped Teflon brush to suspend debris prior to draining.



Removing support grid from frypot prior to filtering.



## BID80 SERIES GAS FRYERS CHAPTER 5: BUILT-IN FILTRATION

---

### 5.4.2 Filter Operation (cont.)

4. After ensuring the filter pan is correctly positioned under the drain tube, and the pan-disconnect is properly connected, pull the red handle to drain the frypot into the filter pan.



Pull the red handle to open the drain valve.

5. After all oil/shortening has drained from the frypot into the filter pan, pull the yellow handle to open the oil return line and activate the filter pump.



Pull the yellow handle to open the oil return valve and activate the filter pump.



## BID80 SERIES GAS FRYERS CHAPTER 5: BUILT-IN FILTRATION

### 5.4.2 Filter Operation (cont.)

- Oil will begin to pump from the filter pan into the frypot. If the frypot tubes, sides and bottom have sediment deposits, clean the frypot with the cleaning brush included with the fryer. Clean beneath and under the burner tubes, using care not to disturb the probes (arrow). Probe location will vary according to fryer system.

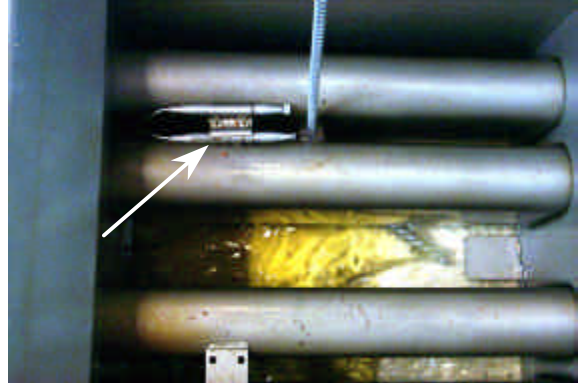

Clean all sediment and suspended particles from the burner tubes and frypot as the oil begins to circulate. Use care not to disturb the probes (arrow) on the burner tube.

- Allow the oil to circulate for approximately 5 minutes (process known as "polishing") to remove suspended particles.

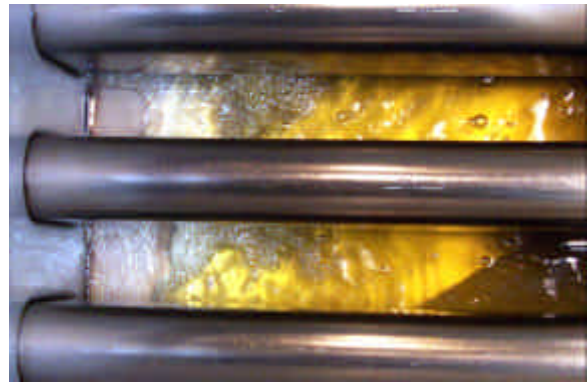

Polishing the oil removes suspended particles, which increases the life of the oil.

- After the filter cycle is complete, close the drain valve (push the red handle until it stops) and allow the fryer to refill (see this section, Step #4 for additional reference).



After filtering is complete, close the red drain handle to start refilling the frypot.

## BID80 SERIES GAS FRYERS CHAPTER 5: BUILT-IN FILTRATION

---

### 5.4.2 Filter Operation (cont.)

9. After all oil is pumped back into the frypot, bubbles will form, indicating air in the oil return lines. Allow the oil to bubble for 10-15 seconds to ensure all shortening/oil is evacuated from the return lines. Push the yellow handle to close the oil return valve and deactivate the filter pump (see this section, Step #5 for additional reference).



Allow the shortening/oil to bubble for 10-15 seconds to ensure evacuation of all shortening/oil in the return lines.

10. If the oil level is low, add oil until the level is at the top OIL LEVEL line. Remember, the oil is at operating temperature.



Add oil/shortening until the oil level is at the top OIL LEVEL line. DO NOT OVERFILL THE FRYPOT.

11. Replace the frypot grid, using care not to splash hot oil. Turn the fryer on.



Replace the frypot grid, using care not to splash hot oil.

**BID80 SERIES GAS FRYERS  
CHAPTER 5: BUILT-IN FILTRATION**

---

**5.4.2 Filter Operation (cont.)**

12. Do not allow crumbs to accumulate in the crumb tray. The crumb tray **MUST** be emptied into a fireproof container at the end of frying operations **EACH** day (see DANGER statement below).

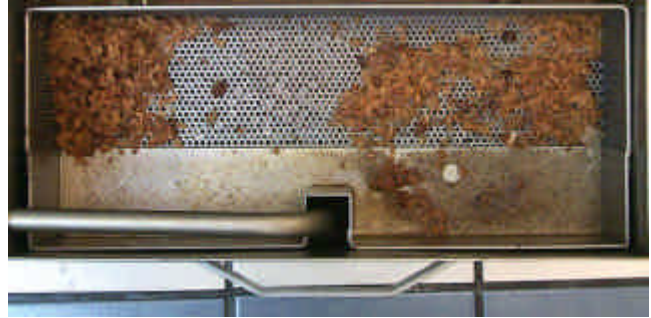

Empty the filter pan crumb tray into a fire-proof container at the end of frying operations each day. **DO NOT ALLOW CRUMBS TO ACCUMULATE IN TRAY.**

**⚠ DANGER**

**The crumb tray in fryers equipped with a filter system must be emptied into a fireproof container at the end of frying operations each day. Some food particles can spontaneously combust if left soaking in certain shortening material.**

**⚠ WARNING**

**Do not bang fry baskets or other utensils on the fryer's joiner strip. The strip is present to seal the joint between the frypots. Banging fry baskets on the strip to dislodge shortening will distort the strip, adversely affecting its fit. It is designed for a tight fit and should only be removed for cleaning.**

# BID80 SERIES GAS FRYERS

## CHAPTER 6: COMPUTER OPERATION

### 6.1 Operating Fryers with Computer Magic III.5 Computers

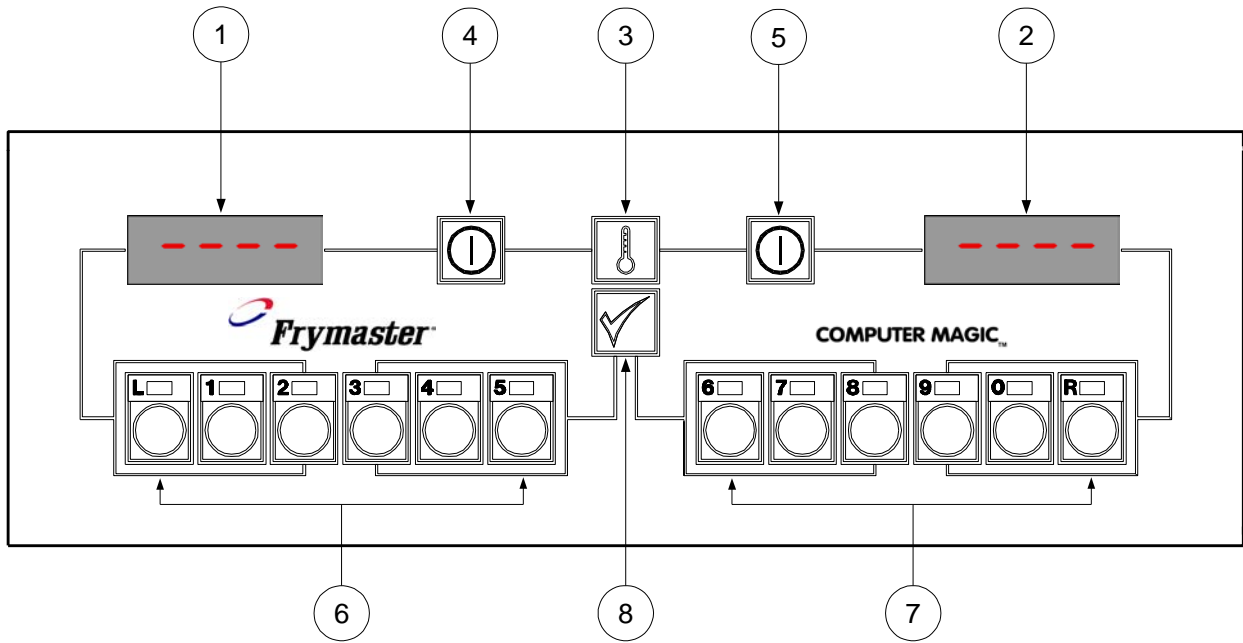

ITEM	DESCRIPTION
1	Lighted Display — left display of various functions and operations.
2	Lighted Display — right display of various functions and operations.
3	Program Lock and Temperature Check Switch — locks program in computer and/or displays frypot temperature when depressed.
4/5	Power Switches — either switch turns power "ON" or "OFF".
6/7	Product and Coding Switches — provides access to computer and programming functions.
8	Programming Switch — used when reprogramming the computer memory.

**⚠ WARNING**  
**Before turning on computer, ensure the fryer is filled with cooking oil/shortening or water. NEVER allow water to enter the Filtration System (if applicable).**

## BID80 SERIES GAS FRYERS

### CHAPTER 6: COMPUTER OPERATION

---

#### 6.1.1 Equipment Setup and Shutdown Procedures

##### Setup

##### **WARNING**

Fill the frypot to the bottom OIL LEVEL line with vegetable oil before pressing the ON/OFF switch  to the "ON" position. Failure to do so could damage the frypot.

1. Fill the frypot with vegetable oil to the bottom OIL LEVEL line located on the rear of the frypot. This will allow for oil expansion as heat is applied. Do not fill cold oil any higher than the bottom line; overflow may occur as heat expands the oil. If solid shortening is used, pack solid shortening into the cool-zone of the frypot. Continue to pack shortening in frypot to the bottom OIL LEVEL line.
2. Ensure that the power cord(s) is/are plugged into the appropriate receptacle(s). Verify that the face of the plug is flush with the outlet plate, with no portion of the prongs visible.
3. Ensure that the vegetable oil level is at the *top* OIL LEVEL line when the vegetable oil *is at its programmed cooking temperature*. It may be necessary to add vegetable oil to bring the level up to the proper mark, *after the oil has reached the programmed cooking temperature*. If solid shortening is used, the MELT cycle **MUST** be used to melt the shortening. It may be necessary to add solid shortening to bring the level up to the proper mark after the packed shortening has melted. **DO NOT DISABLE OR CANCEL THE MELT CYCLE UNTIL ALL SOLID SHORTENING HAS MELTED.**

##### Shutdown

1. Press the ON/OFF switch  to the "OFF" position (the display will show "OFF").
2. Filter vegetable oil (if applicable) and clean fryers. See Chapter 7.
3. Place the frypot covers on frypots.

##### Operating the Fryer

- A. Turn the computer on by pressing the  switch.
  1. One of the following displays will appear:
    - a. *CYCL*, indicating that the burners are operating in the melt-cycle mode. Fryer will remain in the melt-cycle mode until it reaches 180°F (82°C) or is canceled manually.
    - b. *HI*, indicating that the pot temperature is 21°F (12°C) or higher than the setpoint.
    - c. *Lo*, indicating that the pot temperature is 21°F (12°C) or lower than the setpoint.

**BID80 SERIES GAS FRYERS**  
**CHAPTER 6: COMPUTER OPERATION**

---



**6.1.1 Equipment Setup and Shutdown Procedures (cont.)**

- d. " - - - - " indicating that the fryer temperature is in the cooking range. NOTE: For best results, do not cook product until the display reads " - - - - ".
- e. *HELP*, indicates a heating problem.
- f. *HOT*, indicates that the pot temperature is more than 410°F (210°C) [395°F (202°C) for CE (European Community) fryers].
- g. *Prob*, indicates that the computer has detected a problem in the temperature measuring circuits, including probe.

NOTE: "." decimal point between digits 1 and 2 in either display area indicates that the burners are on.

B. Melt-Cycle Cancel Feature (built-in computers only).

 **CAUTION**  
**Do not cancel the melt cycle mode if using solid shortening.**

The computer will display *CYCL* during melt-cycle operation. To cancel melt cycle on a full pot, depress the "R" button . To cancel the melt cycle on a split pot, use the "L" button  for left-side pot and the "R" button  for right-side pot. *CYCL* will be replaced by *Lo*. The decimal point between digits 1 and 2 will illuminate indicating that the burners are on.

C. Cook-cycle operation is initiated by pressing the product switch:

1. The basket lift (on fryers so equipped) will lower the product into the cooking oil/shortening.
2. The display will indicate the programmed cook time and begin countdown.
3. If shake time is programmed, you will be notified to shake the product "*X*" seconds after the cook cycle begins (*X*= amount of time programmed). An alarm will sound and the display will read *SH-* and the product number selected. If no shake time is programmed *SH-* will not appear during the cook cycle.
4. At the end of cooking cycle, an alarm will sound; *COO* will be displayed and the associated product switch indicator will flash. To cancel the cook alarm, press the flashing product switch.



## BID80 SERIES GAS FRYERS



### CHAPTER 6: COMPUTER OPERATION

---

#### 6.1.1 Equipment Setup and Shutdown Procedures (cont.)











5. At this time, the hold time will be displayed (if programmed greater than 0) and countdown will begin. When the hold time counter reaches 0, an alarm will sound. **Hd-** and the product number selected is displayed. The hold alarm is canceled by pushing the  switch. If display is in use, hold time will count down invisibly until display is free.

#### 6.1.2 Checking Temperature

- A. Check the cooking oil/shortening temperature at any time by pressing the  switch once. Check the setpoint by pressing the  switch twice.
- B. During the idle periods, when the fryer is on but not in use, " - - - - " should appear on both displays on a single frypot computer. " - - - - " will appear on the display of the side that is turned on in a split-vat computer. If not, check actual temperature and setpoint.
- C. If you suspect a defective probe, check the cooking oil/shortening temperature with a thermometer. Insert the thermometer within 1-inch of the vessel-mounted probe. Verify that the computer readout is within  $\pm 5^{\circ}\text{F}$  ( $\pm 2^{\circ}\text{C}$ ) of the thermometer reading.

NOTE: The electronic circuitry can be affected adversely by current fluctuations and electrical storms. If for no apparent reason the computer does not function or program properly, reset the computer by unplugging the power cord and plugging it back in.

## 6.2 Programming the Computer Magic III.5 Computer

1. Activate the computer by pressing either  switch.
2. To enter the program mode, first press the  switch. **Code** will appear in the left display. If you have pressed this switch in error and do not wish to program, press the  switch again. Note: The computer will flash **BUSY** if cooking is in progress.
3. Press     (1 6 5 0) in that sequence to enter the program mode.
4. **SP-r** (Setpoint) will appear in the left display. This is for setting the cooking temperature. The temperature previously selected will be displayed in the right display. Enter new temperature. Press the  switch to lock in temperature setting. If the setting is correct, press the  switch to cancel the selection.
5. **SELP** (Select Product) will appear in the left display. Press the product button to be programmed.
6. **SENS** will appear in the left display. The sensitivity number previously selected will be displayed in the right display. Enter the new desired sensitivity number, the range is 1 to 9. Enter "0" for no sensitivity. Press the  switch to lock in the setting.

**BID80 SERIES GAS FRYERS**  
**CHAPTER 6: COMPUTER OPERATION**

---

## 6.2 Programming the Computer Magic III.5 Computer (cont.)

Sensitivity adjusts computer-cooking time to compensate for the drop in cooking oil/shortening temperature when a basket of product is placed into the fryer. Sensitivity decreases or increases cooking time to counterbalance variances in product density, basket-load size, and initial temperature. A proper sensitivity setting will ensure a high quality product. For example: 4 ounces of fries can be programmed to cook to the same quality as 2 pounds. A good initial setting is 4 or 5. Some experimenting with the range of 1 to 9 may be required to achieve optimum quality.

7. **COOC** will now appear in the left display. A previously entered cook-time will appear in the right display. If that time is correct, press the  switch. If you wish to change the time, enter the desired time in minutes and seconds. (The new time will be displayed in the left display.) Press the  switch to lock in the setting.
8. **SH-** now appears in the left display. The previous shake time (if any) will appear in the right display. If a product requires shaking during the cooking process, set the shake time by pressing the number of minutes to cook before shaking. Press the  switch to lock in the time. If no shake time is required, press "0" and press the  switch. Example: Total cook time 3:00 minutes, shake after cooking 1:00 minute.

At the end of 1:00 minute, a beeper will sound and the product button indicator will flash for three seconds.

9. **HD-** will now appear in the left display. Set the time to hold the cooked product from 13 seconds to 60 minutes. Press the  switch. If you do not wish to use the hold time, enter "0" and press the  switch.
10. **SELP** will appear in the left display. If you desire to program more products, return to Step 5. If no more programming is required, lock in program by pressing the  switch.

### 6.2.1 Boil Feature

 **CAUTION**

**Do not drain water or boil-out solution into the filtration system (if applicable). Irreparable damage to the filter system will result and all applicable warranties will be voided.**

1. Before switching the fryer "ON", close the frypot drain valve. Fill empty frypot with mixture of cold water and detergent. Follow detergent instructions when mixing.

**NOTE:** Boil Mode will not turn on both sides of computer. Each side will have to be turned on separately.









## BID80 SERIES GAS FRYERS

### CHAPTER 6: COMPUTER OPERATION







---

#### 6.2.1 Boil Feature (cont.)







2. To program computer for boil feature, press either  switch.
3. Press the  switch. **Code** will appear in the left display.
4. Enter     (1 6 5 3) in that sequence. The right display will read **boil**. The temperature is automatically set for 195°F (91°C). The fryer will attain this temperature and remain there until either  switch is pressed, which cancels the boil-out mode. In high-altitude locations, constantly monitor the fryer for over-boil conditions. If over-boil occurs, turn off fryer immediately, allow to cool, and re-enter boil-out mode to continue the boil-out operation.

**SEE CHAPTER 4.2 FOR ADDITIONAL BOIL-OUT PROCEDURES.**

#### 6.2.2 Temperature Selection—Fahrenheit to Celsius

1. To change the computer temperature from Fahrenheit to Celsius or Celsius to Fahrenheit, press either  switch.
2. Press the  switch. **Code** will appear in the left display.
3. Enter     (1 6 5 8) in that sequence. The computer will automatically convert the temperature from Fahrenheit to Celsius or Celsius to Fahrenheit.
4. Press the  switch to display the temperature in the newly selected mode.

#### 6.2.3 Constant Oil Temperature Display Mode

1. To program constant temperature display, press the  switch.
2. Press the  switch. **Code** will appear in the left display.
3. Enter     (1 6 5 L) in that sequence. The cooking oil/shortening temperature will display constantly in the right display on a full-pot and in both displays on a split-pot.

**NOTE:** During the product cooking process, the cooking time will not be displayed but timing will be taking place.

4. To remove the constant oil-temperature display and display the cooking time, repeat Step 2 and Step 3.

# BID80 SERIES GAS FRYERS

## CHAPTER 7: PREVENTATIVE MAINTENANCE

---

### 7.1 General

 **DANGER**

**Never attempt to clean the fryer during the cooking process or when the frypot is filled with hot oil/shortening. If water comes in contact with oil/shortening heated to cooking temperature, it will cause spattering of the oil/shortening, which can result in severe burns to nearby personnel.**

Any equipment works better and lasts longer when maintained properly and kept clean. Cooking equipment is no exception. The BID80 Series gas fryer should be kept clean during the working day and thoroughly cleaned at the end of each day. Below are recommendations for daily, weekly and periodic preventative maintenance.

### 7.2 Daily

 **WARNING**

**Use a commercial grade cleaner formulated to effectively clean and sanitize food-contact surfaces. Read the directions and precautionary statements for use. Particular attention must be paid to the concentration of cleaner and the length of time the cleaner remains on the food-contact surfaces.**

- A. Remove and wash all removable parts.
- B. Clean all exterior surfaces of the cabinet. Do not use cleaners, steel wool, or any other abrasive material on stainless steel.
- C. Filter the cooking oil (See Chapter 5) and replace if necessary. The oil should be filtered more frequently when under heavy use.

### 7.3 Weekly

- A. Completely drain the oil from the fryer into a metal stockpot of sufficient size to safely hold the entire contents of the frypot for disposal. Do not use a glass or plastic container.
- B. Clean the frypot by following boil-out procedures in Chapter 4.2.

 **WARNING**

**Never allow water to boil down and expose the heating tubes. Frypot damage will result.**

**BID80 SERIES GAS FRYERS**  
**CHAPTER 7: PREVENTATIVE MAINTENANCE**

---

## **7.4 Periodic/Annual**

**This appliance should be inspected and adjusted periodically by qualified service personnel as part of a regular kitchen maintenance program.**

**Frymaster/Dean recommends that this appliance be inspected at least annually by a Factory Authorized Service Technician as follows:**

- Inspect the cabinet inside and out, front and rear for excessive oil build-up and/or oil migration.
- Verify that the flue opening is not obstructed by debris or accumulations of solidified oil or shortening.
- Verify that burners and associated components (i.e. gas valves, pilot assemblies, ignitors, etc.) are in good condition and functioning properly. Inspect all gas connections for leaks and verify that all connections are properly tightened.
- Verify that the burner manifold pressure is in accordance with that specified on the appliance's rating plate.
- Verify that the temperature and high-limit probes are properly connected, tightened and functioning properly, and that mounting hardware and probe guard are present and properly installed.
- Verify that component box components (i.e. computer/controller, transformers, relays, interface boards, etc.) are in good condition and free from oil migration build-up and other debris. Inspect the component box wiring and verify that connections are tight and that wiring is in good condition.
- Verify that all safety features (i.e. drain safety switches, reset switches, etc.) are present and functioning properly.
- Verify that the frypot/cookpot is in good condition and free of leaks and that the frypot/cookpot insulation is in serviceable condition. Verify that the frypot tube diffusers are present and in good condition (i.e. no visible deterioration or damage).
- Verify that wiring harnesses and connections are tight and in good condition.

### **Built-in Filtration:**

- Inspect all oil-return and drain lines for leaks and verify that all connections are tight.
- Inspect the filter pan for leaks and cleanliness. If there is a large accumulation of crumbs in the crumb basket, advise the owner/operator that the crumb basket should be emptied into a fireproof container and cleaned daily.
- Verify that all O-rings and seals (including those on the Power Shower and on quick-disconnect fittings) are present and in good condition. Replace o-rings and seals if worn or damaged.

**BID80 SERIES GAS FRYERS**  
**CHAPTER 7: PREVENTATIVE MAINTENANCE**

---

## 7.4 Periodic/Annual (cont.)

### Built-in Filtration (cont.):

- Check filtration system integrity as follows:
  - With the filter pan empty, place each oil return handle, one at a time, in the ON position. Verify that the pump activates and that bubbles appear in the cooking oil/shortening (or that gurgling is heard from the Power Shower port) of the associated frypot.
  - Close all oil return valves (i.e., place all oil return handles in the OFF position). Verify proper functioning of each oil return valve by activating the filter pump using the lever on one of the oil return handle microswitches. No air bubbles should be visible in any frypot (or no gurgling should be heard from the Power Shower ports).
  - Verify that the filter pan is properly prepared for filtering, then drain a frypot of oil heated to 350°F (177°C) into the filter pan and close the frypot drain valve. Place the oil return handle in the ON position. Allow all cooking oil/shortening to return to the frypot (indicated by bubbles in the cooking oil/shortening or, on units with Power Showers, cessation of oil flow from the Power Shower). Return the oil return handle to the OFF position. The frypot should refill in no more than 2 minutes and 30 seconds.

**To ensure good fryer health and a safe environment, the fryer should be checked and adjusted periodically by qualified service personnel as part of a regular kitchen maintenance program.**

## 7.5 Stainless Steel Care



### **WARNING**

**DO NOT let water splash into the tank of hot oil. It will splatter and can cause severe burns.**

All stainless steel fryer cabinet parts should be wiped regularly with hot, soapy water during the day, and with a liquid cleanser designed for stainless steel at the end of each day.

- A. Do not use steel wool, abrasive cloths, cleansers or powders.
- B. Do not use a metal knife, spatula or any other metal tool to scrape stainless steel! Scratches are almost impossible to remove.
- C. If it is necessary to scrape the stainless steel to remove any encrusted materials, soak the area first to soften the deposit, then use a wood or nylon scraper only.

# BID80 SERIES GAS FRYERS

## CHAPTER 8: TROUBLESHOOTING

---

### 8.1 General

 **DANGER**

**Hot cooking oil/shortening will cause severe burns. Never attempt to move this appliance when filled with hot cooking oil/shortening or to transfer hot cooking oil/shortening from one container to another.**

 **DANGER**

**This equipment should be unplugged when servicing, except when electrical circuit tests are required. Use extreme care when performing such tests.**

**This appliance may have more than one electrical power supply connection point. Disconnect all power cords before servicing.**

**Inspection, testing and repair of electrical components should be performed by an authorized service agent only.**

The problems and possible solutions covered are those most commonly encountered.

To troubleshoot, perform the test set-up at the beginning of each condition. Follow each step in sequence.

### 8.2 Pilot Burner Malfunction

- A. Pilot will not ignite; no evidence of gas at pilot burner.
  - 1. Check that gas valve is open and gas is present at the gas valve.
  - 2. Check pilot burner orifice for dirt or lint.
  - 3. Remove pilot burner gas-supply line and check for contamination; blow out if necessary, then reinstall.
  
- B. Pilot burner ignites but will not remain lit when gas valve manual knob is released.
  - 1. Check that thermocouple lead is properly screwed into thermocouple connection bushing on gas valve.
  - 2. Remove end of thermocouple lead from thermocouple connection bushing and clean with fine sandpaper or emery cloth.
  - 3. Pilot flame may be too high or too low. Adjust pilot flame adjustment screw so that pilot flame extends about ¾-inch (19-mm) above the top of the pilot burner.

**BID 80 SERIES GAS FRYERS**  
**CHAPTER 8: TROUBLESHOOTING**

---

## **8.2 Pilot Burner Malfunction (cont.)**

4. Check all connections for cleanliness and security.
- C. Pilot flame of proper size, but is unstable. Flame wavers and does not envelop the thermocouple completely at all times.
1. Check for drafts that might be caused by air conditioning equipment or make-up air apparatus. Turn air-moving equipment off and recheck the pilot.

## **8.3 Main Burner Malfunctions**

- A. Main burner will not come "ON"; gas not detected at main burner.
1. Check that the gas valve is open.
  2. Check that the pilot is ignited and is operating properly.
  3. Check the high limit switch for continuity.
  4. The combination gas valve may be defective; replace if necessary.
- B. Main burner flames are small and appear lazy; shortening does not come up to temperature quickly.
1. Check gas pressure at the pressure tap of the gas valve. Use dial type or standard water-type U-gauge manometer. With burner in operation, the pressure should be 4" W.C. (10 mbar) for natural gas, and 11" W.C. (27.5 mbar) for propane.
  2. If not, remove the pressure regulator adjustment cover. Use screwdriver to turn the adjusting screw for proper pressure. Replace cover, re-check pressure and re-install pressure tap plug.
- C. Signs of excessive temperature; shortening scorches and quickly becomes discolored.
1. Check gas pressure as outlined above.
  2. Shortening used is of inferior quality and/or shortening has been used too long. Replace shortening.
  3. Ensure vessel is clean when refilling with new shortening.

**BID 80 SERIES GAS FRYERS**  
**CHAPTER 8: TROUBLESHOOTING**

---

**8.3 Main Burner Malfunctions (cont.)**

- D. Fryer will not reach the temperature setting and/or runs erratically.
  - 1. Incorrect location of sensor probe or defective temperature sensor.
  - 2. Loose wiring/wire connection
  
- E. Fryer shortening temperature cannot be controlled; fryer runs at high-limit temperature.
  - 1. Defective operating thermostat or temperature probe.
  - 2. Call Service Technician.

# BID 80 SERIES GAS FRYERS CHAPTER 8: TROUBLESHOOTING

## 8.4 Wiring Diagrams

### 8.4.1 BID80 Series With Built-In Filtration

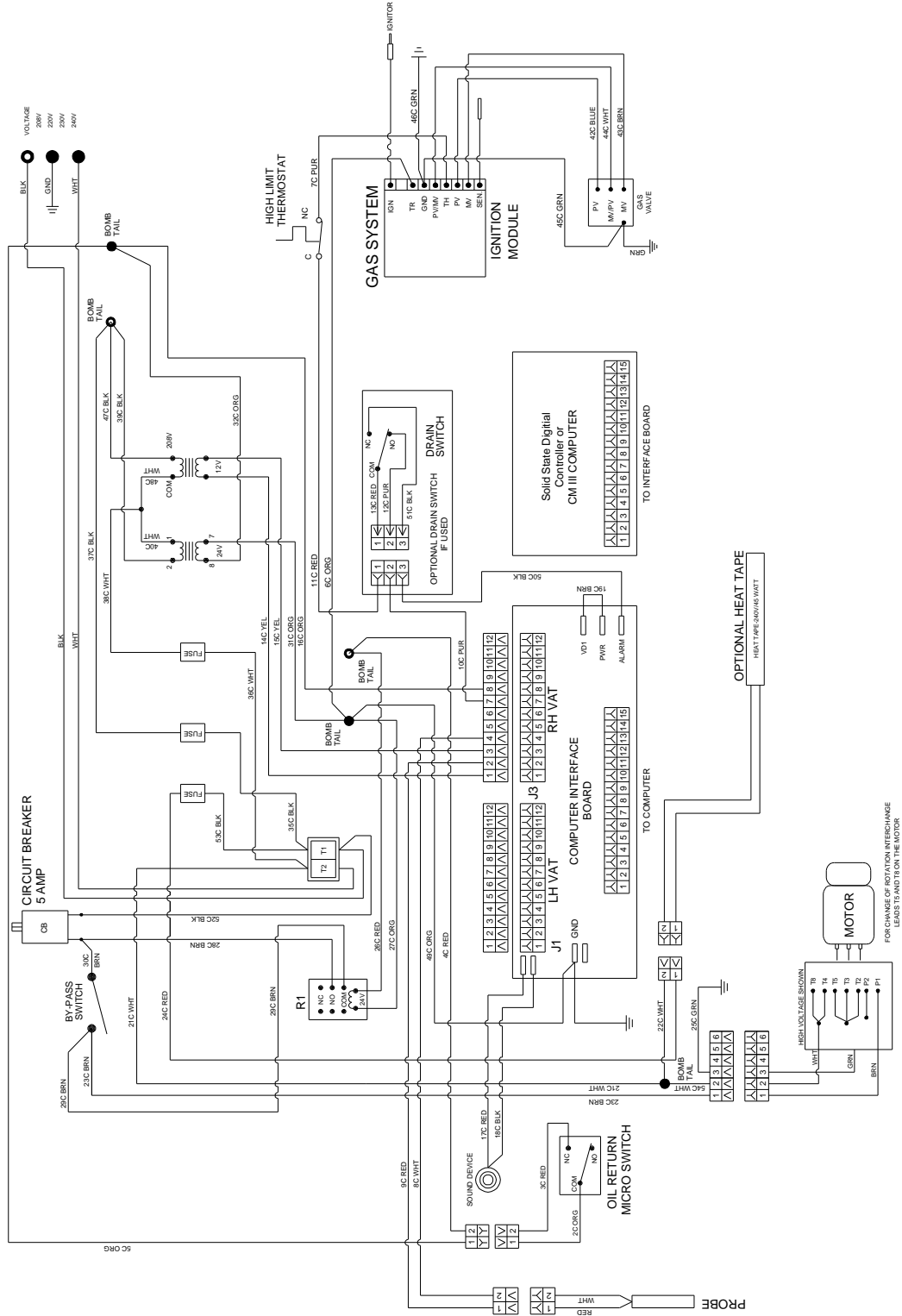



# BID 80 SERIES GAS FRYERS CHAPTER 8: TROUBLESHOOTING

## 8.4.2 BID80 Series Interface Board (Enlarged View)

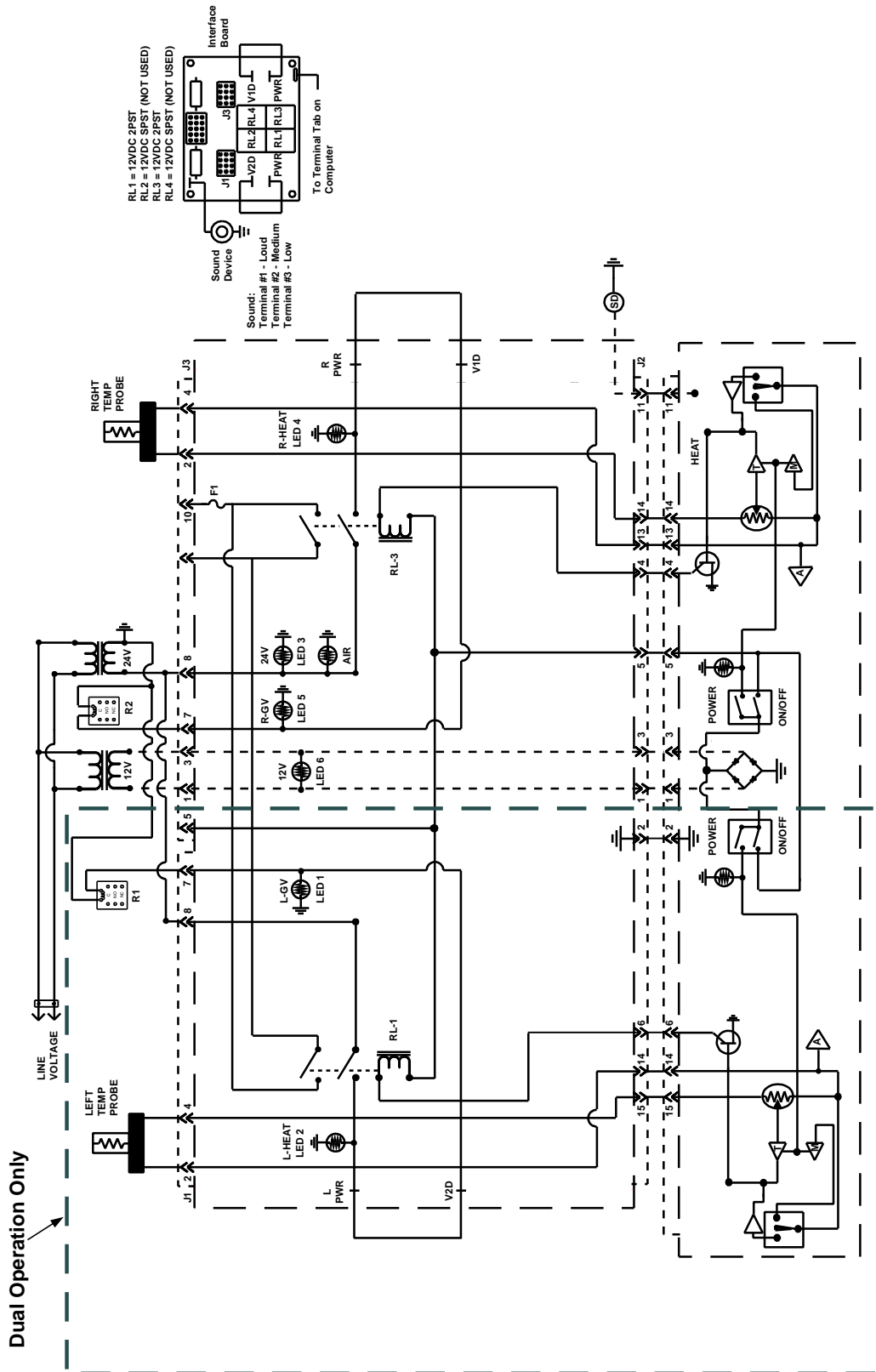

# BID80 SERIES GAS FRYERS

## CHAPTER 9: PARTS LIST

### 9.1 Accessories

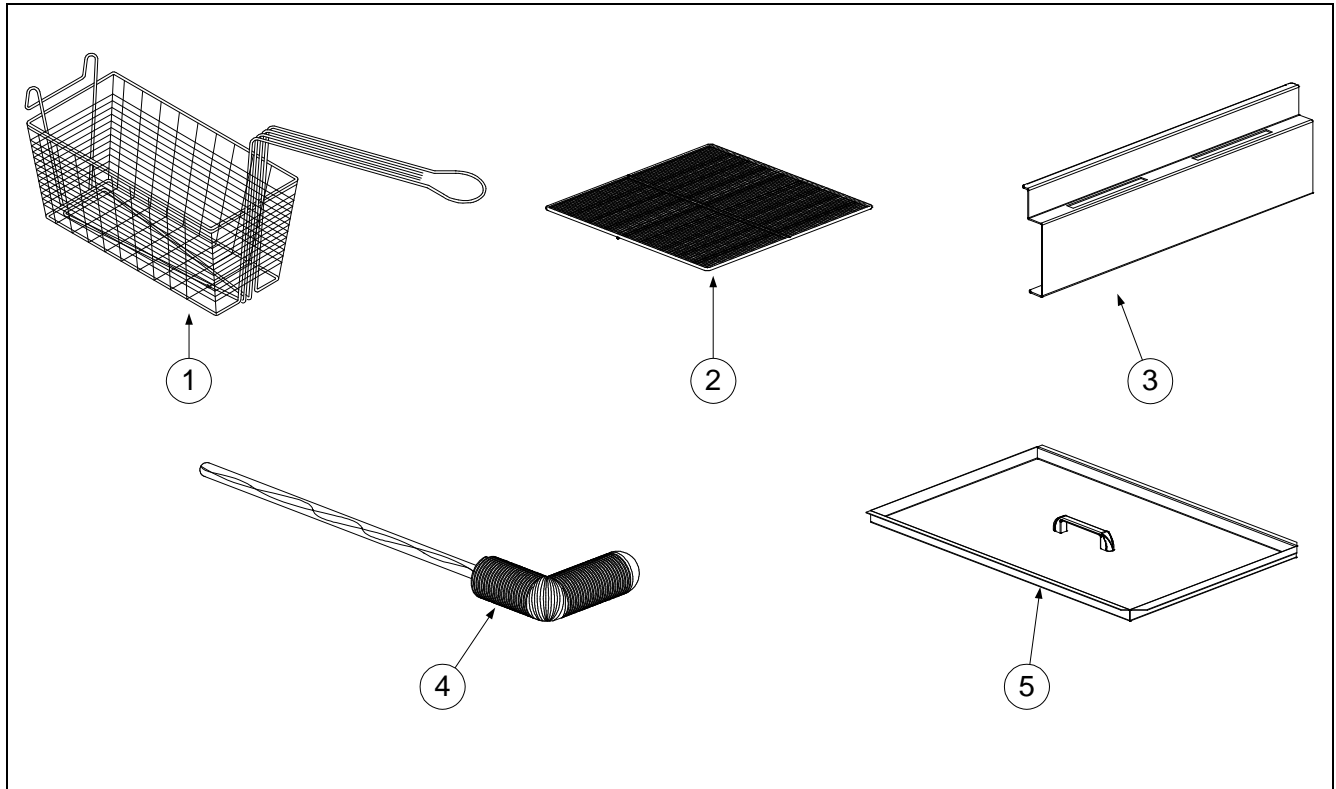

ITEM	PART #	COMPONENT
1	803-0301	Basket, Fry- 6 x 8- <sup>3</sup> / <sub>4</sub> x 16- <sup>3</sup> / <sub>4</sub> (Optional)
2	810-2122	Grid Assembly, Frypot
3	210-3458	Basket Hanger, D180
4	803-0278	Brush, Teflon- L-Shaped
5	106-2470SP	Vat Cover, Frypot (Optional)

**BID80 SERIES GAS FRYERS  
CHAPTER 9: PARTS LIST**

**9.2 Cabinetry and Related Components**

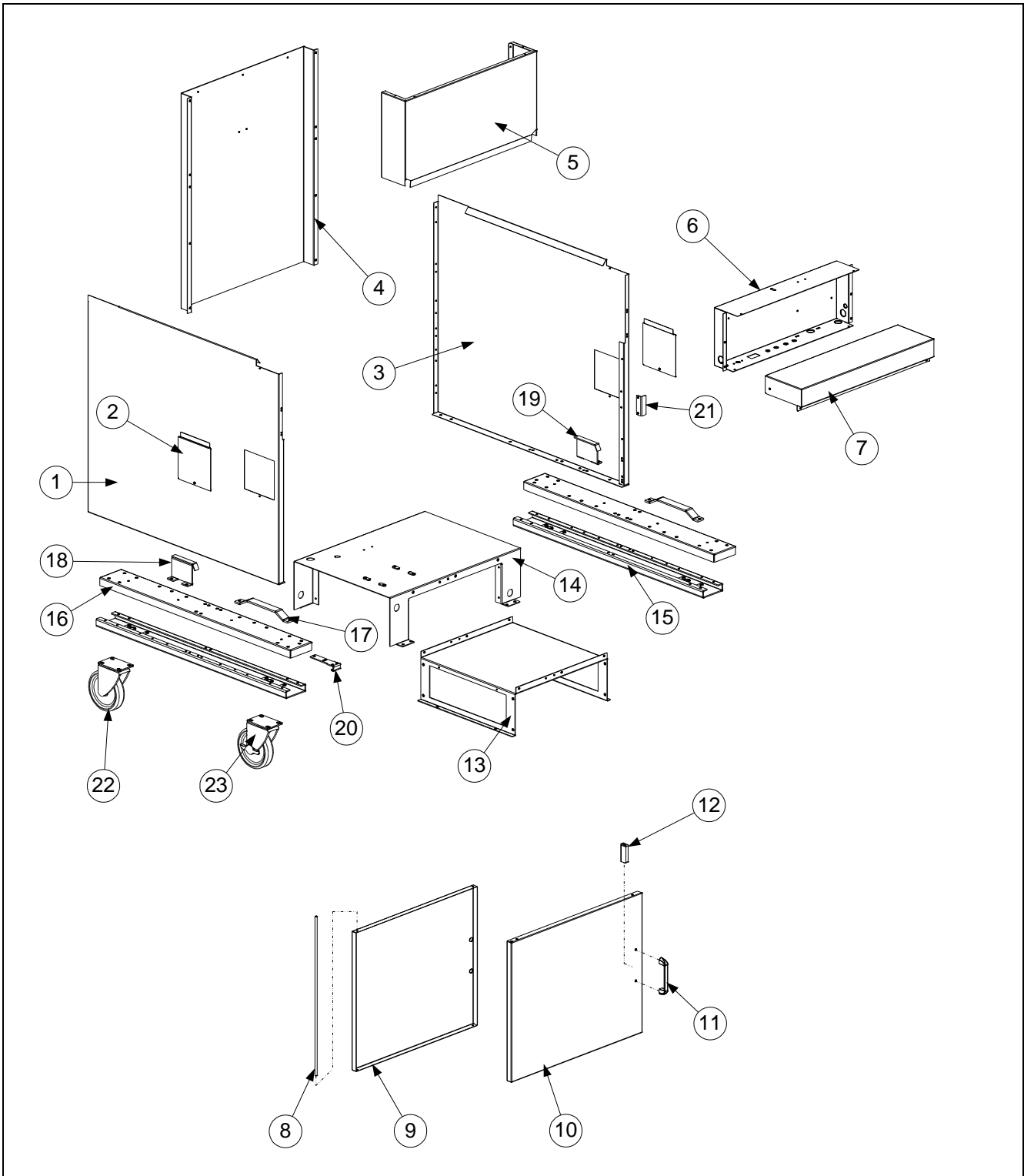

**BID80 SERIES GAS FRYERS  
CHAPTER 9: PARTS LIST**

**9.2 Cabinetry and Related Components (cont.)**

ITEM	PART #	COMPONENT
1	211-2532	Side, Cabinet- Left
2	210-1365	Duct, Door Access
3	212-2532	Side, Cabinet- Right
4	200-2683	Back, Cabinet
*	200-1376	Bracket, Restraining
*	200-3635SP	Crossbrace, Cabinet Back, Lower
5	823-3512	Flue Cap
6	824-0954	Box, Component (Wireway Control)
7	824-0986	Top Cap
8	200-1301	Pin, Door
9	200-2688	Panel, Inner- Door
*	810-0179	Plug, Handle-Screw Access
*	816-0529	Bumper, Rubber (Self-Adhesive)
*	809-0193	Bushing, Nylon (Door Pin)
10	210-1151	Panel, Outer- Door
11	810-2105	Handle, Chrome (With Screws)
12	810-0066	Magnetic Catch, Door
13	200-3403	Base, Lower Frame
*	200-3461	Cover, Access- Lower Frame Base (2 Required)
14	823-3745	Base, Upper Frame
15	823-3724	Channel, Leg Support (Right and Left)
16	200-3459	Base, Leg Channel
17	210-3588	Slide, Front- Filter Pan
18	823-3751	Slide, Rear <b>Left</b> - Filter Pan
19	823-3752	Slide, Rear <b>Right</b> - Filter Pan
20	200-1675	Bracket, Lower Door Hinge
21	210-2870	Plate, Door Magnet
22	810-0356	Caster, Without Brake
23	810-0357	Caster, With Brake

\* Not Illustrated

**BID80 SERIES GAS FRYERS**  
**CHAPTER 9: PARTS LIST**

**9.3 Computer and Related Components**

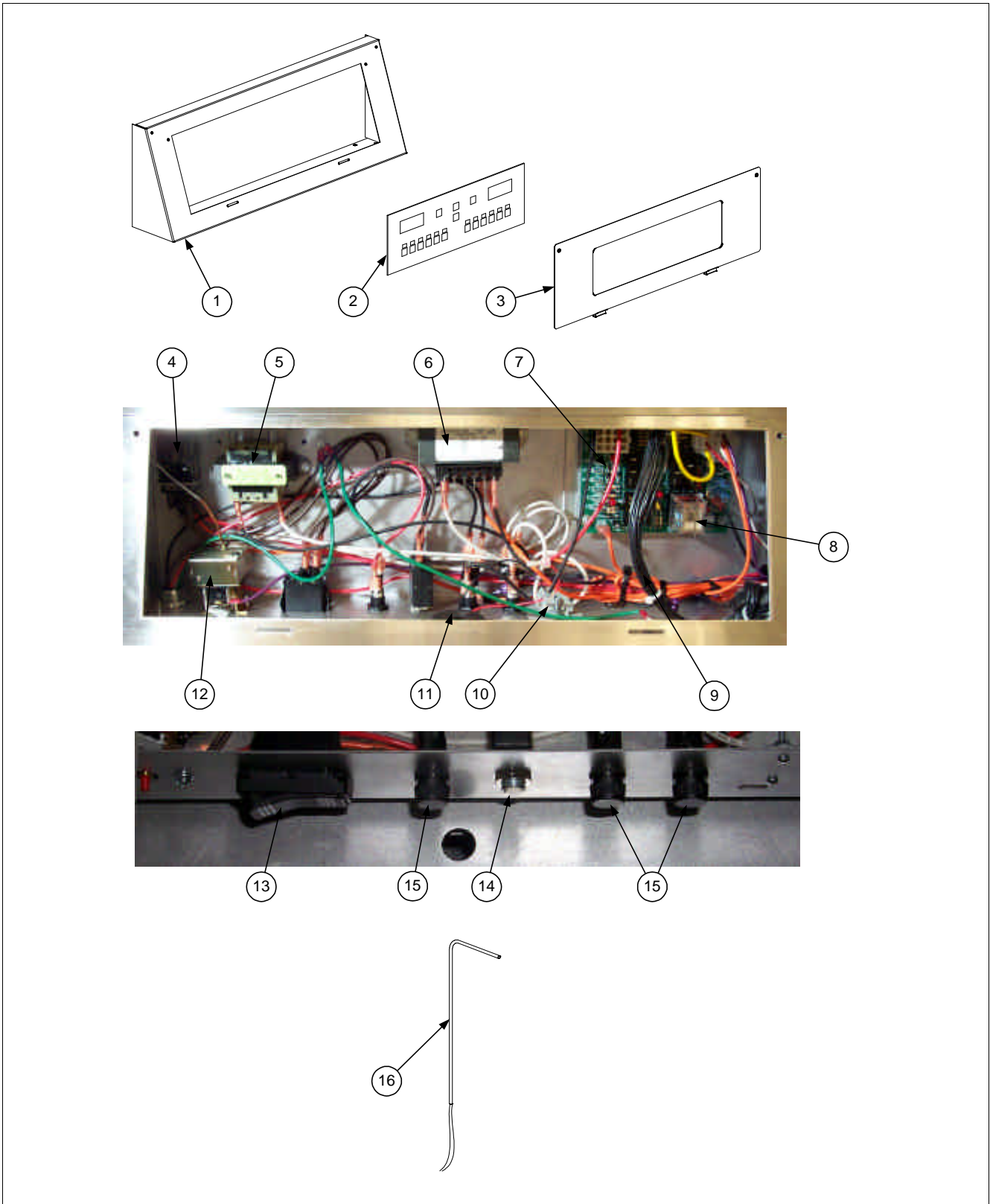

**BID80 SERIES GAS FRYERS  
CHAPTER 9: PARTS LIST**

**9.3 Computer and Related Components (cont.)**

ITEM	PART #	COMPONENT
1	210-3463	Panel, Control- BID80
2	106-2334	Computer, CMIII.5- BID80
3	823-3433	Bezel, Computer
4	807-3611	Relay, 24 Amp (Filter Circuit)
5	807-0979	Transformer, 208/240V - 12V- Secondary
6	807-1999	Transformer, 208/240V – Dual Voltage
7	806-4549	Board, Interface
8	807-0833	Relay, 5 Amp (Latch Relay- Interface Board)
9	806-2071	Harness, Wire- Computer To Interface Board
10	810-1164	Block, Terminal (Power In)
*	816-0217	Insulation, Terminal Block
11	806-7179SP	Sound Device
12	807-3680	Thermostat, High-Limit- 450°F Manual Reset
*	810-2046	Spring, Spacer- High-Limit Bulb
13	807-3580	Switch, Rocker- Filter Pump Bypass Switch
14	807-3538	Circuit Breaker, 5 Amp
15	807-1321	Holder, Fuse- Buss Fuse
*	807-3592	Fuse, 2 Amp
16	106-1424	Probe Assembly, Sensor
*	210-1386	Clamp, Probe Bulb and High-Limit Bulb
*	810-2164	Spring, Spacer- Probe Bulb
*	809-0448	Clip, Tinnerman (Sensor Probe and High-Limit Probe Clamp)
*	809-0360	Screw, Probe/H-Limit Bulb Clamp- #8 x 3/8 Slotted Hex Head
* Not Illustrated		

**BID80 SERIES GAS FRYERS  
CHAPTER 9: PARTS LIST**

**9.4 Drain Valve Components**

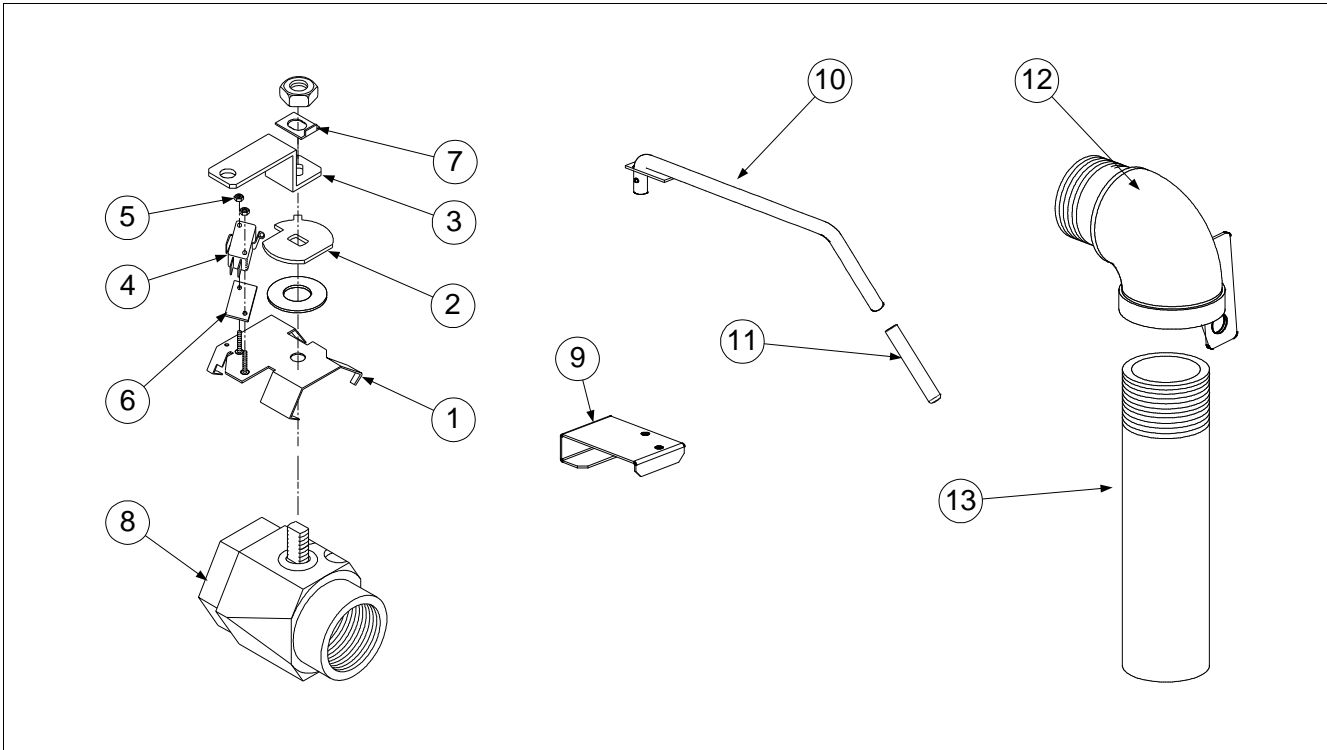

ITEM	PART #	COMPONENT
1	106-1401	Bracket, Microswitch
2	210-2029	Activator, Microswitch
3	200-1940	Handle, Drain Arm- Push/Pull
4	807-2104	Microswitch
5	809-0842	Nut, Nylock #4-40
6	816-0220	Insulation, Microswitch
7	200-1257	Retainer, Nut- Drain Valve Arm
8	810-2127	Drain Valve, 1-1/2"
9	200-1269	Guard, Microswitch
10	823-3429	Handle, Drain Valve
11	816-0547	Cap, Handle- Red
12	823-3747	Elbow/Bracket Assembly, Drain Valve
13	813-0784	Drain Nipple- 6"

\* Not Illustrated

**BID80 SERIES GAS FRYERS  
CHAPTER 9: PARTS LIST**

**9.5 Filter Pan Components**

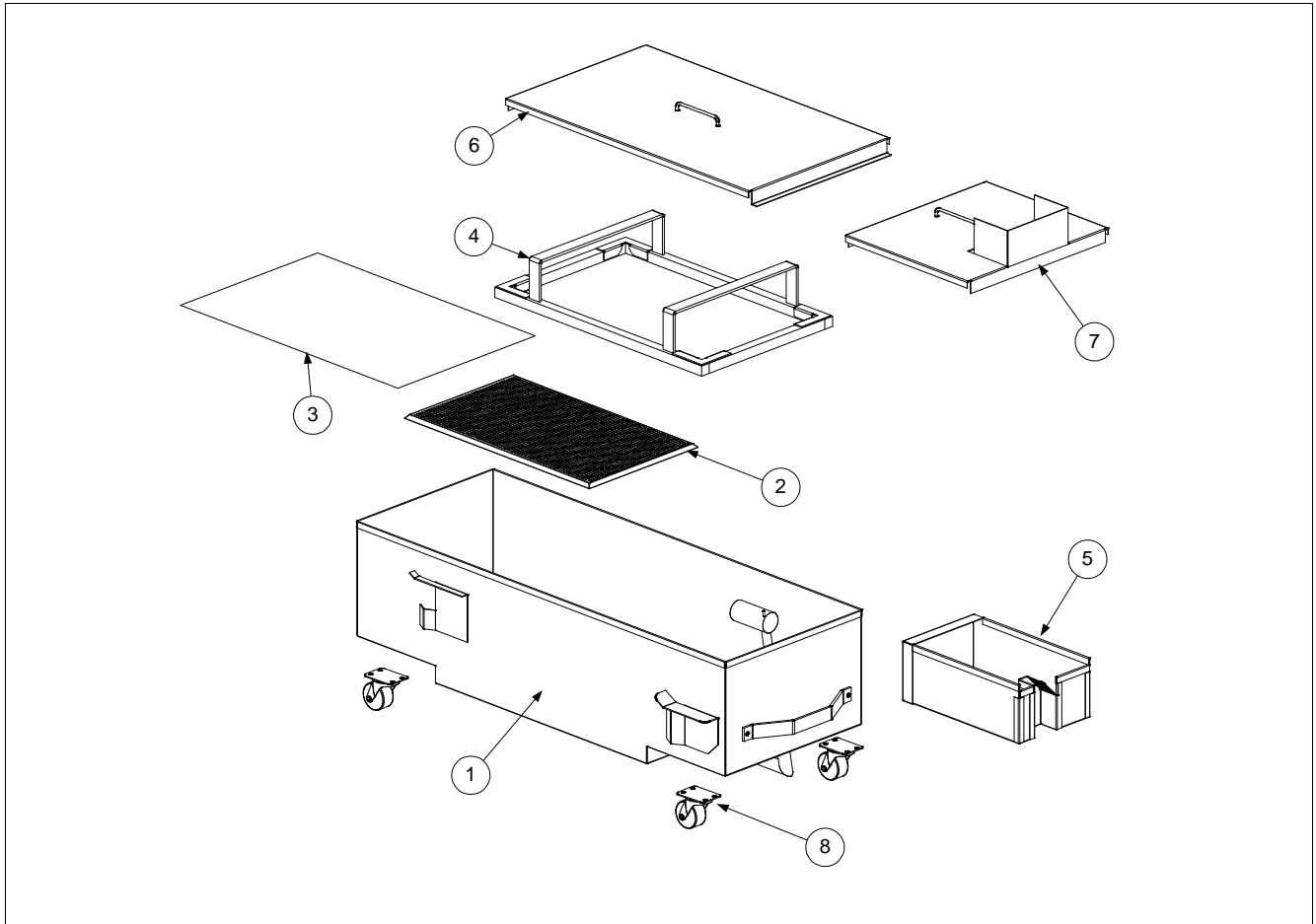

ITEM	PART #	COMPONENT
1	823-3750SP	Filter Pan Assembly
*	813-0684	Plug, Hex Socket, 3/8" NPT
*	813-0679	Plug, 1/8" SS Square Head (Female Disconnect)
2	823-3748	Grid, Bottom- Filter Pan
3	803-0289	Paper, Filter- 22 x 34" (100 Sheets)
*	803-0002	Powder, Filter (Carton)
4	823-3742	Ring, Hold-Down (Weighted)
5	823-3736	Basket (Tray), Crumb
6	823-3741	Lid, Pan- Rear
7	823-3739	Lid, Pan- Front
8	810-2141	Caster, 2"- Filter Pan

\* Not Illustrated



BID80 SERIES GAS FRYERS  
CHAPTER 9: PARTS LIST

9.6 Frypot, Burners and Related Components

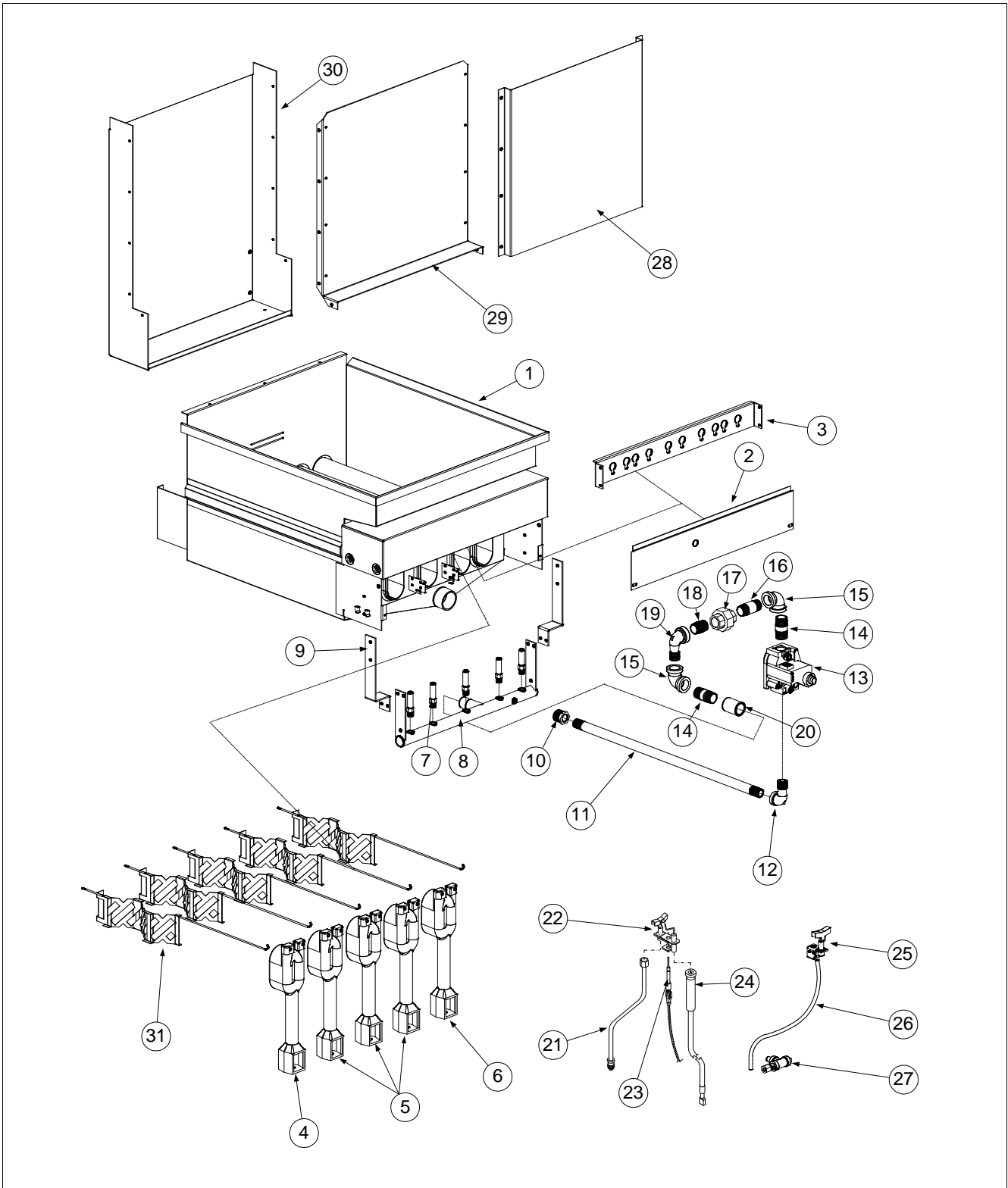

**BID80 SERIES GAS FRYERS  
CHAPTER 9: PARTS LIST**

**9.6 Frypot, Burners and Related Components (cont.)**

ITEM	PART #	COMPONENT
1	823-3396SP	Frypot, SS- 1-½" Drain System
2	200-2707	Shield, Heat- Front
3	200-2734	Bracket, Burner Mounting
4	810-2151	Burner, Left
5	810-2149	Burner, Center
6	810-2150	Burner, Right
7	810-2365	Orifice #56 (1.19 mm)
8	810-2072	Manifold, Gas
9	200-1314	Support, Manifold- Left and Right
10	813-0031	Bushing, Hex- ½ to ¾" NPT BM
11	813-0607	Nipple, ½ x 23-½" NPT BM
12	813-0165	Elbow, Street- 90° ½" NPT BM
13	807-3628	Valve, Gas- Honeywell ½ x ¾" 10" W.C.
14	813-0112	Nipple, ¾ x 2" NPT BM
15	813-0066	Elbow, 90° NPT BM
16	813-0635	Nipple, ¾ x 2-¼" NPT BM
17	813-0174	Union, ¾" NPT BM
18	813-0109	Nipple, ¾" x Close NPT BM
19	813-0168	Elbow, Street- 90° ¾" NPT BM
20	813-0359	Coupling, ¾ x 1.62" NPT
21	810-0705	Gas Line, Pilot- One Piece- 23"
22	807-1553	Pilot Assembly, LP
23	807-1310	Sensor, Flame
24	807-1315	Cable, Ignition
25	810-2155	Pilot Burner Assembly, Trailing Pilot-LP
26	810-0703	Gas Line, Trailing Pilot- One Piece- 17-½"
27	810-2138	Valve, Trailing Pilot
28	200-1316	Shield, Flue
29	200-1347	Front, Flue
30	200-1349	Rear, Flue
*	809-0167	Screw, Sheet Metal- 10A x 5/8"
31	823-3513	Diffuser, BID80

\* Not Illustrated

**BID80 SERIES GAS FRYERS**  
**CHAPTER 9: PARTS LIST**

**9.7 Oil Return Components**

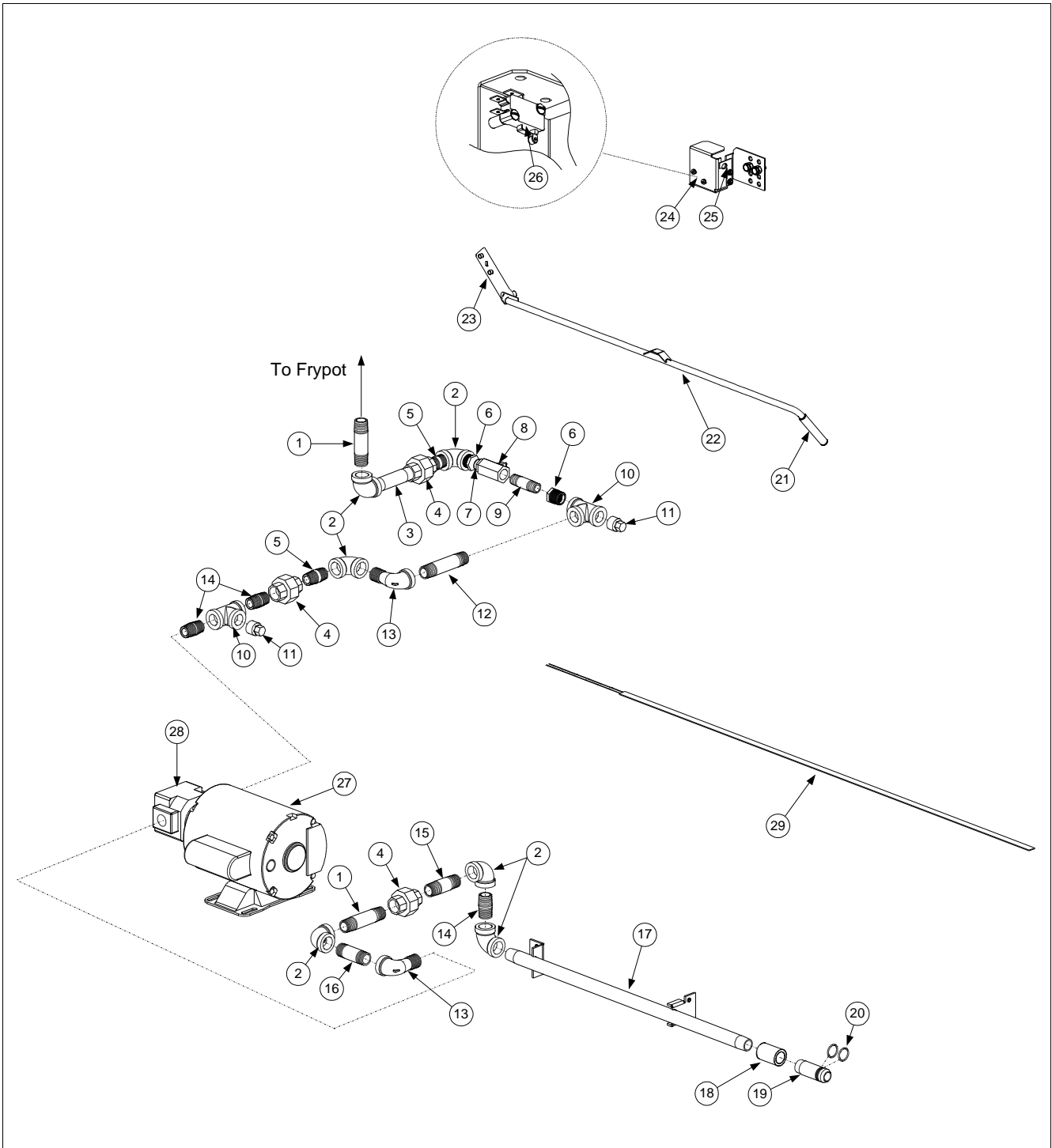

**BID80 SERIES GAS FRYERS  
CHAPTER 9: PARTS LIST**

**9.7 Oil Return Components (cont.)**

ITEM	PART #	COMPONENT
1	813-0460	Nipple, ½ x 3" NPT MB
2	813-0062	Elbow, ½" 90° NPT BM
3	813-0247	Nipple, ½ x 3-½" NPT BM
4	813-0173	Union, ½" NPT BM
5	813-0087	Nipple, ½ x 1-½" NPT BM
6	813-0006	Bushing, ½" to 3/8 NPT BM
7	813-0625	Nipple, 3/8" x Close NPT BM
8	810-2125	Valve, Oil Return- 3/8"
9	813-0644	Nipple, 3/8 x 1-½" NPT BM
10	813-0003	Tee, ½" NPT BM
11	813-0156	Plug, ½" NPT BM
12	813-0247	Nipple, ½ x 3-½" NPT BM
13	813-0165	Elbow, Street- 90° NPT BM
14	813-0022	Nipple, ½" x Close NPT BM
15	813-0265	Nipple, ½ x 2-½" NPT BM
16	813-0661	Nipple, ½ x 2-¼" NPT BM
17	823-3754	Manifold, Suction- Oil Return
18	813-0608	Coupling, ½" x Full NPT BM
19	810-0697	Disconnect, Male- Suction Manifold
20	826-1392	O-Ring, Suction Manifold Disconnect (Qty:5)
21	816-0548	Cap, Handle- Yellow
22	823-3187	Handle, Oil Return
23	823-3344	Handle, Oil Return Arm- Push/Pull
*	809-0885	Washer, 3/8 x 1 x 0.83" Type A Plain
24	202-1233	Bracket, Oil Return Microswitch (RH)
*	826-1389	Screw, ¼-20 x ¾" Hex Head (Qty:10)
*	809-0823	Nut, Nylock- ¼-20
*	809-0825	Nut, Spacer- Kep ¼-20 Hex Head SS
25	200-1341	Bracket, Microswitch Rod
*	826-1371	Screw, Microswitch Rod Bracket (Qty: 25)
26	807-2104	Microswitch, Oil Return
*	809-0846	Screw, 4-40 x 1 Slotted Head- Microswitch
*	826-1366	Nut, 4-40 Keps Hex with External Teeth (Qty: 25)
*	810-2144	Spacer, Aluminum- ¼" O.D. x 3/8"L 4-40
27	810-2100	Motor, 1/3HP 120/230V/50/60Hz
28	810-2252	Pump, Filter- 5GPM
29	807-1419	Strip, Heater- 240V/45W 36"L

\* Not Illustrated

**THIS PAGE INTENTIONALLY LEFT BLANK**



Frymaster, L.L.C., 8700 Line Avenue, PO Box 51000, Shreveport, Louisiana 71135-1000  
Shipping Address: 8700 Line Avenue, Shreveport, Louisiana 71106

TEL 1-318-865-1711 FAX (Parts) 1-318-219-7140 FAX (Tech Support) 1-318-219-7135

PRINTED IN THE UNITED STATES

SERVICE HOTLINE  
1-800-551-8633

Price: \$10.00  
819-5896  
APRIL 2002