

# Jazzy 1103

Owner's Manual



**≡ How a Power Chair Should Feel!™**

**Pride**  
Mobility Products, Ltd.

Alber Technologies Limited,  
Chantry Court, Sovereign Way,  
Chester, England. CH1 4QN  
Tel: 01244 394240 Fax: 01244 394254  
Email: [Info@alber.co.uk](mailto:Info@alber.co.uk) [www.alber.co.uk](http://www.alber.co.uk)

# SAFETY GUIDELINES

Please read and follow all instructions in this owner's manual before attempting to operate your power chair for the first time. If there is anything in this manual you do not understand, or if you require additional assistance for set-up, contact your local authorized Pride provider.

Using your Pride product safely depends upon your diligence in following the warnings, cautions, and instructions in this owner's manual. Using your Pride product safely also depends upon your own good judgement and/or common sense, as well as that of your provider, caregiver, and/or healthcare professional. Pride is not responsible for injuries and/or damage resulting from any person's failure to follow the warnings, cautions, and instructions in this owner's manual. Pride is not responsible for injuries and/or damage resulting from any person's failure to exercise good judgement and/or common sense.

The symbols below are used throughout this owner's manual to identify warnings and cautions. It is very important for you to read and understand them completely.



**WARNING!** Failure to heed the warnings in this owner's manual may result in personal injury.



**CAUTION!** Failure to heed the cautions in this owner's manual may result in damage to your power chair.

# C O N T E N T S

<b>I. INTRODUCTION</b> .....	4
<b>II. SAFETY</b> .....	6
<b>III. OPERATION</b> .....	8
<b>IV. COMFORT ADJUSTMENTS</b> .....	18
<b>V. DISASSEMBLY</b> .....	22
<b>VI. CARE AND MAINTENANCE</b> .....	23
<b>VII. OPTIONAL ACCESSORIES</b> .....	28
<b>VIII. WARRANTY</b> .....	32

# I. INTRODUCTION

Welcome to Pride Mobility Products, Ltd. (Pride). Congratulations on the purchase of your new Jazzy power chair. The Jazzy 1103 design combines the most advanced state-of-the-art components with modern, attractive styling. We are certain that the design features and trouble-free operation of your new Jazzy power chair will add convenience to your daily living.

At Pride, your safety is important to us. **Please read and follow all of the instructions in this manual before you attempt to operate your Jazzy for the first time.** These instructions were produced for your benefit. Your understanding of these instructions is essential for the safe operation of your new Jazzy power chair.

Pride is not liable for damage to property or personal injury arising out of unsafe use of a Jazzy power chair. Pride is also not liable for any property damage or personal injury arising out of the failure of any person and or/user to following the instructions and recommendations set forth in this manual or any other instructions or recommendations contained in other Jazzy related literature issued by Pride or contained on the Jazzy power chair itself.

This owner's manual is compiled from the latest specifications and product information available at the time of publication. We reserve the right to make changes as they become necessary. Any changes to our products may cause slight variations between the illustrations and explanations in this manual and the product you had purchased.

If you experience any problems with your Jazzy that your are unable to solve, or if you do not feel capable of safely following any of the instructions and/or recommendations as contained in this manual, please contact your authorized Pride provider for assistance.

Once you understand how to operate and take care of your Jazzy, we are certain that it will give you years of trouble-free service and enjoyment.

## Information Exchange

We want to hear your questions, comments, and suggestions about this manual. We would also like to hear about the safety and reliability of your new Jazzy power chair, and about the service you received from your authorized Pride provider.

Please notify us of any change of address, so we can keep you apprised of important information about safety, new products, and new options that can increase your ability to use and enjoy your Jazzy. Please feel free to write us at the address below:

Alber Technologies Limited,  
Chantry Court, Sovereign Way,  
Chester, England. CH1 4QN  
Tel: 01244 394240 Fax: 01244 394254  
Email: [Info@alber.co.uk](mailto:Info@alber.co.uk) [www.alber.co.uk](http://www.alber.co.uk)

# I. INTRODUCTION

## **Pride Owners Club**

As an owner of a Pride product, you are invited to register your product's warranty and enroll in the Pride Owners Club. You may do so by filling out and returning your enclosed registration card or by visiting Pride's web site at [www.pridemobility.com](http://www.pridemobility.com). As a registered member, each time you visit our site, you will have access to the most interactive and honest educational venue available today for people with mobility needs, their families and friends.

From our home page, click on the button that reads "Owners Club" to enter a page dedicated to current and potential Pride product owners. You will gain access to interviews, stories, recreation ideas, daily living tips, product and funding information, and interactive message boards. On these message boards you are invited to speak with other Pride customers as well as Pride representatives who are available to assist you with any questions or concerns you may have. You will receive a free gift simply for registering with the Pride Owners Club.

## **My Authorized Pride Provider is:**

Name: \_\_\_\_\_

Address: \_\_\_\_\_

Phone Number: \_\_\_\_\_

## **Quick Reference Information:**

Jazzy Model: \_\_\_\_\_

Serial Number: \_\_\_\_\_

Purchase Date: \_\_\_\_\_

*NOTE: If you ever lose or misplace your warranty card or your copy of this manual, call or write to us and we will be glad to send you a new one immediately.*

## II. SAFETY

The Jazzy 1103 is a state-of-the-art life-enhancement device designed to enhance your mobility. There are, however, certain situations—including some medical conditions—where you will need to practice operating your Jazzy 1103 in the presence of an attendant. Below are some safety tips that are designed to help you become accustomed to your new Jazzy.



**WARNING: The Jazzy 1103 is a motorized vehicle. When you are seated in your Jazzy 1103 and you anticipate that you are going to be in a stationary position for an extended period of time, turn off the power. This eliminates the possibility of unexpected movement and conserves battery power.**

### TRANSFERS

Transferring onto and off of your Jazzy 1103 requires a good sense of balance. Be sure to have an attendant or health care professional present while learning to properly transfer yourself. To eliminate the possibility of injury, we ask that you verify the following before attempting a transfer:

1. Be sure the power is turned off.
2. Be sure the Jazzy 1103 is not in the freewheel mode.
3. Make sure the armrests are flipped up or removed from the powered wheelchair.
4. Tip the footrest up; this helps to keep your feet from hanging up on the footrest during the transfer.



**WARNING: Avoid putting all of your weight on the footrest. This may cause the Jazzy 1103 to tip and cause injury!**

### MOTOR VEHICLE TRANSPORT

Though your Jazzy may be equipped with a positioning belt, this belt was not designed with the intent of providing proper restraint during motor vehicle transport.

- Never sit on or allow anyone to sit on the Jazzy 1103 in a moving vehicle.
- Always be sure your Jazzy 1103 is properly secured when being transported.

### TIE-DOWN SYSTEM DISCLAIMER

Neither Pride nor its providers assume responsibility for the Jazzy used in vehicle tie-down applications.

### WEIGHT LIMITATIONS

Your Jazzy 1103 is rated for an 113 kg/18 stone maximum weight limit. Exceeding the weight limit voids your Jazzy warranty and may result in personal injury.

### STAIRS AND ESCALATORS

Wheelchairs are not designed to travel up or down stairs or escalators. Always use an elevator. If you try to navigate steps or escalators, you can cause injury to yourself and others.

## II. SAFETY

### PUBLIC ROADS AND PARKING LOTS



**WARNING: Do not operate your Jazzy 1103 on public streets and roadways. Please be aware it may be difficult for traffic to see you when you are seated in your Jazzy. To ensure your safety, always assume you cannot be seen. Obey all local pedestrian traffic rules. Safety accessories like reflectors, fluorescent flags, and various lighting packages are available to order from your Pride provider.**

### STEPS AND KERBS

- Do not attempt to climb a step or kerb higher than 3 cm.
- Always have assistance when attempting to climb a step or kerb lower than 3 cm.
- Never attempt to proceed backwards down any step, kerb, or other obstacle. Doing so could cause the Jazzy 1103 to tip.

### INCLINES AND UNEVEN TERRAIN

When climbing an incline, do not zigzag or drive at an angle up the face of the incline. Drive your Jazzy straight up the incline. This greatly reduces the possibility of a tip or fall. Always exercise extreme caution when navigating an incline.

- Never travel up or down an incline that can be potentially hazardous (e.g., areas covered with snow, ice, wet leaves, or cut grass).
- When climbing an incline, try to keep the chair moving. If you must stop, start up again slowly and accelerate cautiously.

When moving down an incline, do so slowly and in the forward direction only. If your Jazzy 1103 starts to move faster than you anticipated, allow the unit to come to a complete stop by releasing the joystick. Then push the joystick forward slightly and continue traveling down the incline.

### MAXIMUM RECOMMENDED INCLINE

Pride has performed extensive incline testing with your Jazzy 1103. Our results have shown that the maximum incline you can climb is 8.7% grade at maximum weight capacity. An 8.7% grade is the angle of most handicap access ramps. Any attempt to climb a steeper slope may put your Jazzy in an unstable position.

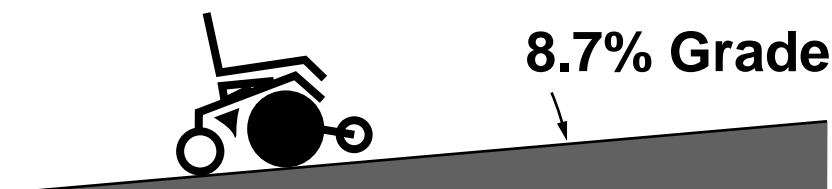

# III. OPERATION

## JAZZY 1103 COMPONENTS

Your Jazzy has two main assemblies: the seat and the power base. See figure 1. There are a variety of seating options that are designed to accommodate most users. Typically, the seating system includes armrests, seatback, seat base, and joystick. Your Jazzy seat may also have some optional accessories attached to it, such as a basket, cane/crutch holder, a cup holder, or a power seat switch.

The power base is the heart of the Jazzy. The power base assembly includes two motor/brake assemblies, two anti-tip assemblies, two drive wheels, two anti-tip wheels, a caster assembly with two rear casters, two batteries, power seat actuator (optional), a connector housing, and all wiring harnesses. See figure 1 below and figures 2 and 3.

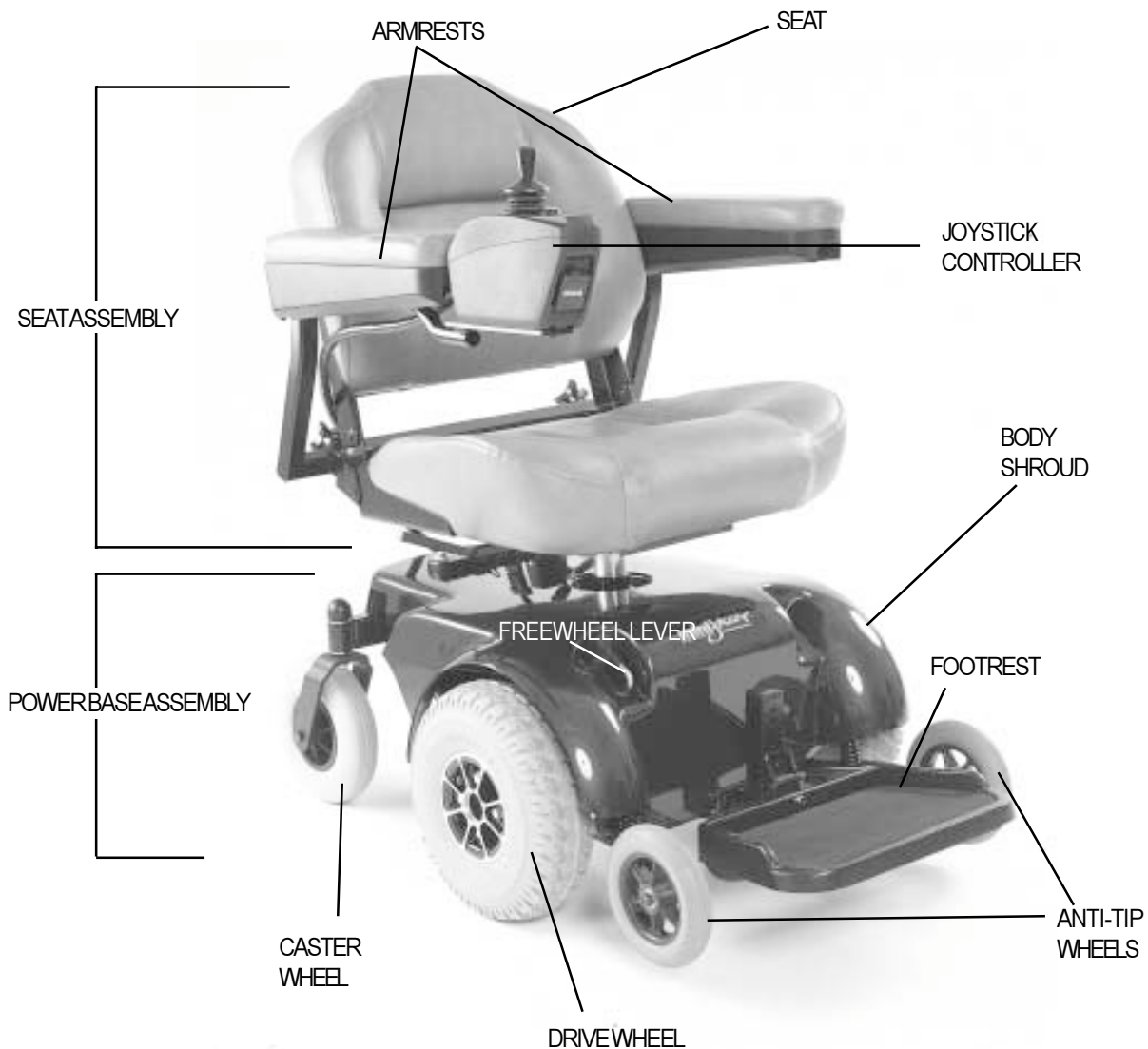

**FIGURE 1. The Jazzy 1103**



## III. OPERATION

<b>Specifications</b>	
Suspension:	Full suspension
Drive Wheels:	25 cm pneumatic, center-mounted (solid tyres are optional)
Rear Casters:	20 cm solid, rear articulating
Anti-tip:	15 cm solid, front mounted
Max. Speed:	6 km/hr
Brakes:	“Intelligent Braking,” electronic regenerative, disc park brake
Ground Clearance:	9 cm
Turning Radius:	47 cm
Overall Size:	Length: 91 cm Width: 58 cm
Seating Options:	Low Back Medium Back (standard) Highback with headrest Power Elevating Option Available
Drive Train:	Two-motor, mid-wheel, high speed
Batteries:	Two 12 volt, U-1 batteries
Range:	Up to 32 km
Battery Charger:	5-amp Off-board 3-amp Onboard (optional)
Electronics:	50-amp Pilot Controller
Weight Capacity:	113 kg/18 stone
Component Weights:	Base: 37 kg Seat: 13 kg Batteries: 11 kg each
Warranty:	Lifetime limited warranty on frame 2-year electronics warranty 18 months on drive motors

# III. OPERATION

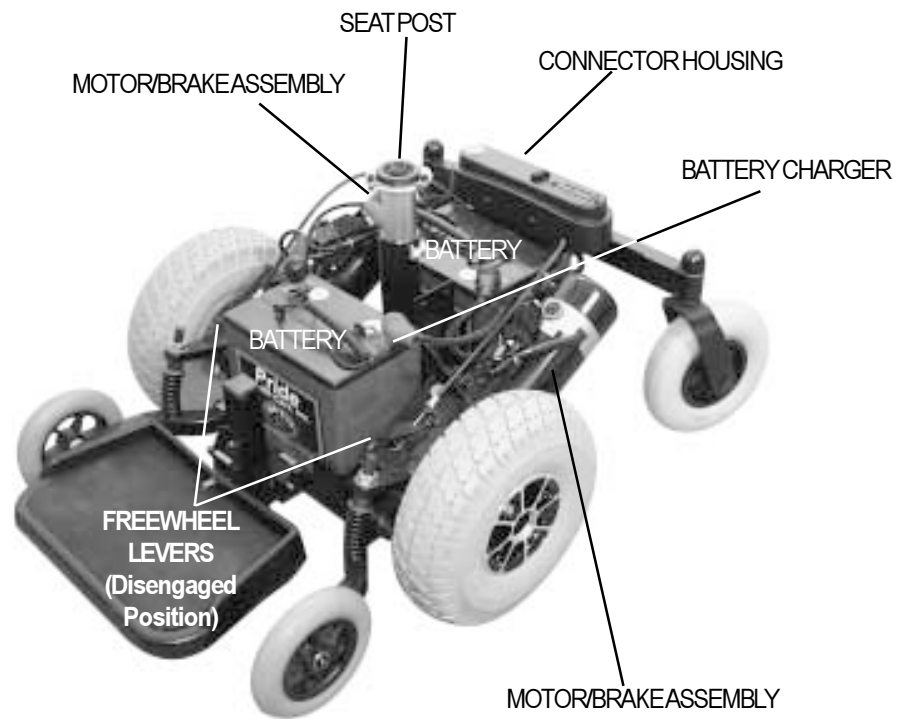

**FIGURE 2. Jazzy 1103 Power Base (shroud removed)**

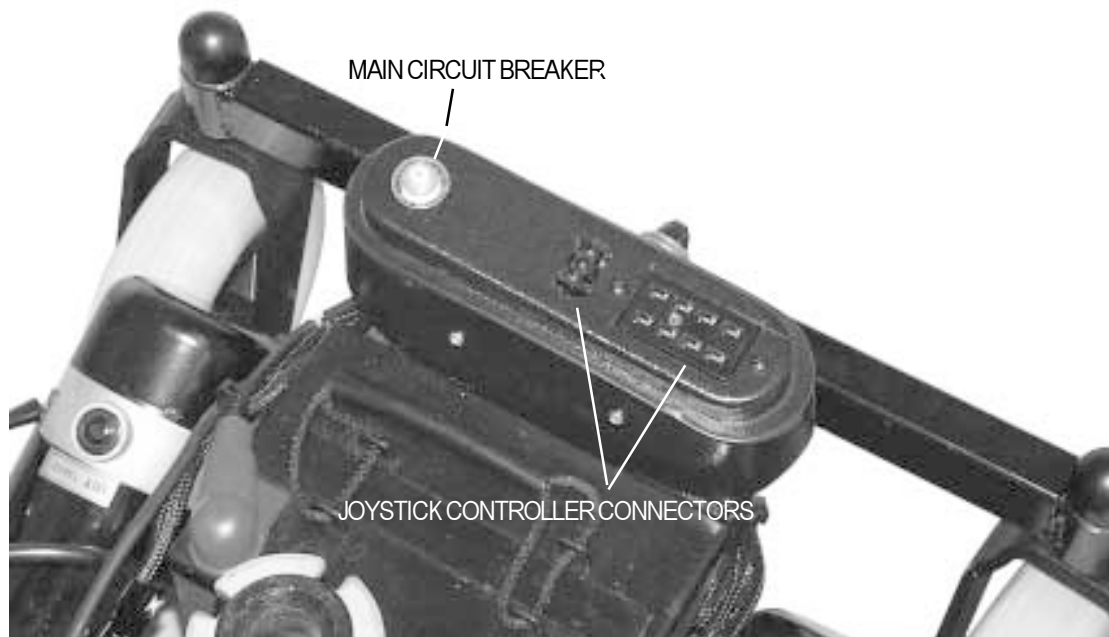

**FIGURE 3. Electronics Connector Housing (non power seat)**

# III. OPERATION

## ELECTRONICS CONNECTOR HOUSING

The connector housing is located on the rear of the Jazzy. See figure 3. The connector housing holds the main circuit breaker and controller harness connectors.

**Main circuit breaker:** The main circuit breaker is a safety feature built into your Jazzy 1103. When the batteries and the motors are heavily strained (e.g., from excessive loads), the main circuit breaker trips to prevent damage to the motors and the electronics. If the circuit trips, allow the Jazzy to “rest” for approximately one minute. Then, push in the circuit breaker button, turn the controller power back on, and continue normal operation. If the main circuit breaker continues to trip repeatedly, contact your authorized Pride provider.

**Controller Harness Connectors:** These are where the joystick cables connect to the power base.

## FREEWHEEL LEVERS

For convenience, your Jazzy 1103 is equipped with two freewheel levers. See figure 2. These levers allow you to disengage the drive motors and maneuver the chair manually.

### To engage or disengage the drive motors:

1. Locate the two (2) metal levers protruding from the body shroud.
2. Turn them outward to engage the drive motors.
3. Turn them inward to disengage the drive motors.

If the lever is difficult to move in either direction, slightly rock the Jazzy 1103 back and forth. The lever should then move to the desired position.

**Remember:** When the Jazzy 1103 is in the freewheel mode, the braking system is disengaged.



**WARNING: DO NOT use the Jazzy 1103 while the drive motors are disengaged! DO NOT disengage the drive motors when the Jazzy 1103 is on an incline, as the unit could roll on its own, causing injury!**

## III. OPERATION

### BATTERIES AND BATTERY CHARGING

Your Jazzy 1103 uses two long-lasting, 12-volt batteries. These batteries are sealed, maintenance-free, deep-cycle batteries. Since they are sealed, there is no need to check the electrolyte (fluid) level. Deep-cycle batteries are designed to handle a deep discharge. Though they are similar in appearance to automotive batteries, they are not interchangeable. Automotive batteries are not designed to handle a long, deep discharge and also are unsafe.



**WARNING: You must recharge your Jazzy 1103's batteries with the supplied off-board charging system. Do not use an automotive-type battery charger!**

#### To charge the batteries using the off-board charger:

1. Position your Jazzy 1103 close to a standard wall outlet.
2. Be certain the controller power is turned off and the Jazzy is not in freewheel.
3. Insert the 3-pin charger lead plug into the joystick programming port located at the front of the Jazzy's joystick controller. See figure 11.
4. Extend the charger power lead and plug it into the wall outlet. The Jazzy 1103 incorporates an inhibit function that disables the powered wheelchair when the charger is plugged into a wall outlet.
5. We recommend you charge the batteries for 8 to 14 hours. As the batteries charge, the indicator lights located on the back of the charger are lighted from green to yellow to red (red indicating that the battery is fully charged).
6. When your Jazzy 1103 batteries are fully charged, unplug the charger power lead from the wall outlet and from the joystick programming port.



**FIGURE 11. 3-Pin Charger Lead Plugged into the Joystick Programming Port**

## III. OPERATION

### BATTERY BREAK-IN

To break in your Jazzy's new batteries for maximum efficiency:

1. Fully recharge any new battery prior to initial use. This brings the battery up to about 90% of its peak performance.
2. Run your Jazzy 1103 about the house. Move slowly at first and don't stray too far until you become accustomed to the controls and break in the batteries.
3. Give the batteries another full charge of 8 to 14 hours and run the Jazzy 1103 again. The batteries should now perform at over 90% of their potential.
4. After four or five charging cycles, the batteries top off at 100% charge and last for an extended period.

### BATTERIES - FREQUENTLY ASKED QUESTIONS (FAQS)

#### How often must I charge the batteries?

Many factors come into play when deciding how often to charge the batteries. You may use your Jazzy 1103 all day on a daily basis or you may not use it for weeks at a time.

##### Daily Use

If you use your Jazzy 1103 on a daily basis, charge the batteries as soon as you are finished using it for the day. Your Jazzy 1103 will be ready each morning to give you a full day's service. We recommend that you charge the batteries 8 to 14 hours after daily use. Do not charge the batteries for more than 24 hours.

##### Infrequent Use

If you use your Jazzy 1103 infrequently (once a week or less), you should charge it at least once per week for 12 to 14 hours.

**REMEMBER:** Keep the batteries fully charged and avoid deeply discharging the batteries. Do not charge for more than 24 hours.

#### How can I get maximum range or distance per charge?

Rarely will you have an ideal driving situation, such as smooth, flat, hard terrain with no hills or curves. More often you are presented with hills, pavement cracks, uneven and loosely packed surfaces, and curves. All of these factors affect the distance or running time per battery charge. The following are a few suggestions for obtaining the maximum range per charge:

- Always charge the batteries fully prior to your trip.
- Maintain 30-35 psi in pneumatic drive wheels.
- Plan your trip in advance to avoid inclines if possible.
- Limit the baggage weight to essential items.

## III. OPERATION

### What type of battery should I use?

We recommend deep-cycle batteries that are sealed and maintenance free. Both Sealed Lead Acid (SLA) and Gel Cell are deep-cycle batteries and are similar in performance. Use these specifications to reorder deep-cycle batteries:

Battery Specifications	
Type:	Deep-Cycle Sealed Lead Acid or Gel Cell
Size:	U-1
Voltage:	12 volts each
Amp Hours:	30—35 amp hours

### Why do my new batteries seem weak?

Deep-cycle batteries employ a different chemical technology from that used in car batteries, nickel-cadmium (nicads), or in other common battery types. Deep-cycle batteries are specifically designed to provide power, drain down, and then accept a relatively quick recharge. Lead acid batteries should be charged as often as possible. They do not have a “memory” like nicads.

We work closely with our battery manufacturer to provide a battery that best suits the Jazzy 1103’s specific demands. Fresh batteries arrive regularly and are promptly shipped with a full charge. During shipping, the batteries encounter temperature extremes that may influence their initial performance. Heat robs the charge from the battery, and cold slows the power available and extends the time needed to recharge the battery (just as with a car battery).

It might take a few days for the temperature of the battery to stabilize and adjust to its new ambient temperature. More importantly, it takes a few “charging cycles” (a partial drain—then full recharge) to establish the critical chemical balance that is essential to the battery’s peak performance and long life.

It is well worth it for you to take the time to break in the batteries properly.

**REMEMBER:** The useful life of a battery is quite often a reflection of the care it receives.

### How can I insure maximum battery life?

A fully charged deep-cycle battery provides reliable performance and extended battery life, so keep the batteries fully charged whenever possible. Batteries that are regularly and deeply discharged, infrequently charged, or stored without a full charge may become permanently damaged, causing unreliable Jazzy operation and limited life.

### How should I store my Jazzy 1103 and batteries?

If you do not use your Jazzy 1103 regularly, we recommend maintaining battery vitality by charging the batteries at least once a week.

If you do not plan on using your Jazzy 1103 for an extended period, fully charge the batteries prior to storage. Disconnect the battery harnesses and store the Jazzy in a warm, dry environment. Avoid temperature extremes, such as freezing conditions and excessively hot conditions, and never attempt to charge a frozen battery. A cold or frozen battery should be warmed for several days prior to recharging.

## III. OPERATION

*NOTE: If you are storing a Jazzy 1103 for an extended period of time, you may wish to block the unit up off the ground with several boards under the frame. This will keep the tyres off the ground and prevent the possibility of flat spots developing.*

### JAZZY OPERATION/CONTROLLER

You control the speed and direction of your Jazzy by moving the joystick.

#### To operate your Jazzy:

1. Turn it on (push the on/off button). The battery condition meter lights, indicating the present charge of your battery.
2. Push the joystick in the direction you wish to move. The farther you push the joystick from the center (neutral) position, the faster the Jazzy 1103 moves.

### JOYSTICK CONTROLLER

The controller translates the speed and directional information from the joystick for the motors. It has self-diagnostic features that are designed to search for potential problems at the rate of 100 times per second. If the controller detects a problem in the wheelchair's electrical system, the wheelchair may, depending on the severity of the problem, stop functioning. (See "Trouble Codes.")

The controller is designed to maximize user safety under normal operating conditions. This controller, however, cannot take into account circumstances that put the Jazzy 1103 outside of its normal operating environment as described within this manual. It is very important that you follow the precautions described within this manual.

### PILOT CONTROLLER

The Jazzy 1103 is currently available with the Pilot controller. The Pilot controller is located directly underneath the joystick—on the seat arm. See figure 12. The Pilot controller is connected to the motors, batteries, and battery charger through two connectors on the electronics connector housing. See figure 3.

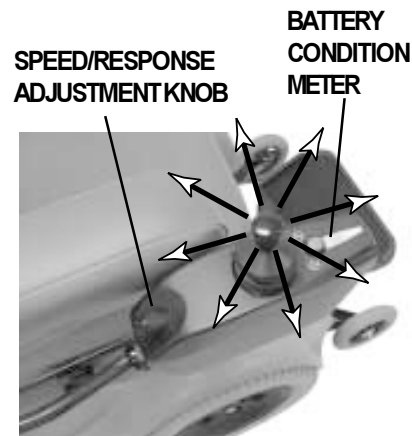

**FIGURE 12. Pilot Controller**

## III. OPERATION

### JOYSTICK FUNCTIONS

The joystick controls the direction and speed of the wheelchair. When you move the joystick from the center (neutral) position, the electromagnetic brake releases and allows the wheelchair to move. The further you push the joystick from its neutral position the faster you can move the chair. When you release the joystick and allow it to return to the neutral position, you engage the electromagnetic brake. This causes the chair to decelerate and come to a complete stop.



**CAUTION: In an emergency, you can use the on/off button to stop the Jazzy. However, the sudden deceleration can result in your unexpected movement and possible injury.**

### SPEED AND RESPONSE ADJUSTMENTS

The Pilot controller is equipped with a speed and response adjustment knob that helps you select the speed and response settings best suited to your requirements and environment. See figure 12. The knob controls the speed at which the Jazzy 1103 responds to joystick movement. When this knob is turned completely counterclockwise, the forward and reverse acceleration and braking are slowed substantially. When this knob is turned fully clockwise, the Jazzy 1103 responds to joystick commands in a more lively fashion.

*NOTE: We recommend that the first few times you operate your Jazzy 1103 that you turn the speed and response knob completely counterclockwise to allow you to become familiar with your new Jazzy 1103.*

### BATTERY CONDITION METER

The battery condition meter is located immediately in front of the joystick. This enables you to monitor battery life. The battery condition meter indicates the approximate amount of battery life left. See figure 12.

- Red, yellow, and green bars indicate that the batteries are fully charged.
- Red and yellow bars indicate that you should charge the battery if possible.
- Red bars indicate that you should charge the battery as soon as possible, because low battery voltage may cause the chair to become inoperative.

*NOTE: When the batteries begin to approach a discharged state, the first red bar will begin to slowly flash, reminding you the batteries need to be charged immediately!*

### TROUBLE CODES

In addition to indicating the current state of battery charge, the battery condition meter can also indicate possible problems with your Jazzy 1103. If the battery condition meter is flashing rapidly, the controller may be indicating a fault.

The meter itself has ten individual bars. The bars are meant to provide information by the amount of bars that are flashing. For instance, the very first red bar flashing rapidly indicates that the battery voltage is nearly depleted. The following is a list of the possible errors signified by the rapidly flashing meter.



## III. OPERATION

FLASHING BARS	DIAGNOSIS	SOLUTION
10	High Battery Voltage	Check Batteries
9	Solenoid Brake Fault	Check Motor/Brake Wiring
8	Possible Controller Fault	See Authorized Provider Service Center
7	Possible Joystick Fault	See Authorized Provider Service Center
6	Inhibit Active	Unplug Charger/Check Connections
5	Right Motor Wiring Fault	Check Right Motor Wiring
4	Right Motor Disconnected	Check Right Motor Wiring
3	Left Motor Wiring Fault	Check Left Motor Wiring
2	Left Motor Disconnected	Check Left Motor Wiring
1	Low Battery Voltage	Check Batteries/Battery Wiring

If you cannot resolve your problem, see an authorized Pride provider or service center.

### Charger Inhibit Plug Connection

The charger inhibit connector on the utility tray is coded with colored dots. The dots are positioned so that you align the flat side of the male connector with the flat side of the female connector before making the connection.



**CAUTION! Failure to properly align the connectors can result in damage to the controller, the charger harness, and the connectors.**

### THERMAL ROLLBACK

Both Jazzy 1103 controllers are equipped with a thermal rollback circuit. This circuit monitors the temperature of the motors and the controller. In the event that the motors or controller become excessively hot (above 50°C/122°F), the controller reduces the motor voltage. For every degree above 50°C/122°F, the controller reduces the voltage by 5 volts. This reduces your speed and allows the components to cool down. When the temperature returns to a safe level, your Jazzy 1103 resumes its normal speed.

## IV. COMFORT ADJUSTMENTS

After you have had your Jazzy for an extended period of time, you may find the need to adjust the seat. There are some adjustments you can make to increase your comfort, such as seat height and armrest angle. If your Jazzy 1103 was configured at your local Pride provider or service center, please consult your health care professional before changing seat position, or making any other adjustments. Some of these adjustments may decrease your Jazzy's performance and safety by changing its center of gravity.

### SEAT HEIGHT

You can change the seat height to one of three positions in 2.5 cm increments.

#### To change the seat height:

1. Remove the seat. See V, "Disassembly" in this manual.
2. Remove the shroud.
3. Use two 9/16-in. wrenches to loosen and remove the hex head nut and bolt. See figure 4.
4. Slide the seat pedestal up or down in the seat pedestal base.
5. Align the holes on the seat pedestal and the seat pedestal base.
6. Reinstall the hex head bolt and tighten.

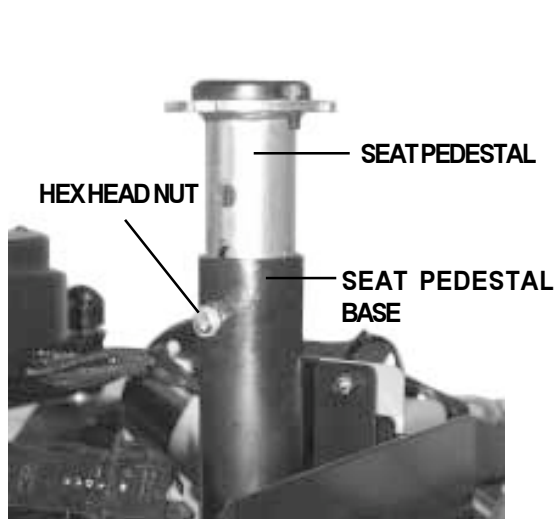

**FIGURE 4. Seat Height Adjustment**



**FIGURE 5. Armrest Width**

### ARMREST WIDTH ADJUSTMENT

#### To change the armrest width:

1. Locate the two knobs on the armrest receiver bracket. See figure 5.
2. Loosen the knobs; slide the armrests in or out for the desired width.
3. Retighten the knobs.

## IV. COMFORT ADJUSTMENTS

### ARMREST ANGLE ADJUSTMENT

You can adjust the armrest angle to fit your specific needs.

#### To change the armrest angle:

1. Lift the armrest straight up so that it is perpendicular to the floor.
2. Use a 7/16-in. wrench to loosen the locking nut. See figure 6.
3. Use a 5/32-in. hex key to loosen the hex nut. Turn the screw clockwise to raise the front of the armrest and counterclockwise to lower the front of the armrest.
4. Lock the adjusting screw into place by tightening the locking nut.

### JOYSTICK EXTENSION ADJUSTMENT

The joystick controller can easily slide out away from the armrest, or in toward the armrest.

#### To extend the joystick:

1. Use a 3/16-in. hex wrench to loosen the setscrew.
2. Slide the joystick mounting bracket into or out of the armrest to the desired position. See figure 7.
3. Retighten the setscrew by turning it clockwise.

### JOYSTICK POSITION

You can position the joystick for either left-hand or right-hand use.

#### To change the joystick position:

1. Disconnect the controller harness connectors. See figure 3.
2. Cut the wire tie that attaches the controller cable to the armrest. See figure 8.
3. Use a 3/16-in. hex wrench to loosen the setscrew. See figure 7.
4. Slide the joystick mounting out of the armrest.
5. Loosen the setscrew in the other armrest.
6. Place the joystick bracket in the other armrest.
7. Tighten the setscrew.
8. Connect the controller cable to the armrest with a wire tie. See figure 8.

TURN THIS SCREW TO CHANGE ARMREST ANGLE



**FIGURE 6. Armrest Angle**

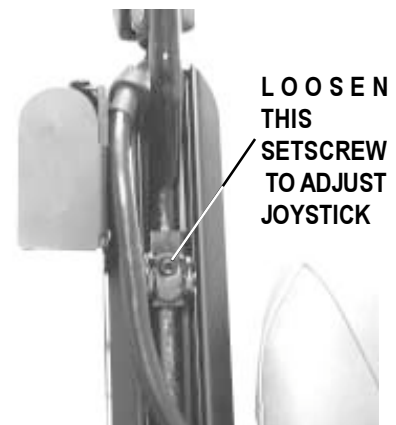

**FIGURE 7. Joystick Extension**

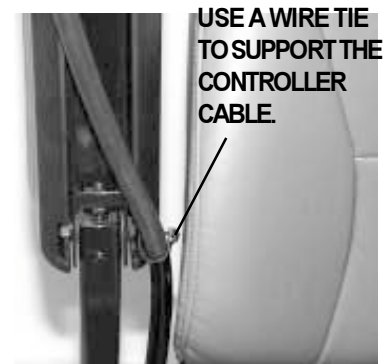

**FIGURE 8. Wire Tie Location**

## IV. COMFORT ADJUSTMENTS

### FOOTREST HEIGHT

The footrest height is easily adjusted to six different heights. See figure 9.

#### To raise or lower the footrest:

1. Remove the seat and the body shroud. See V, “Disassembly.”
2. Remove the two 7/16-in. bolts from the footrest.
3. Raise or lower the footrest to the desired height.
4. Reinstall the two 7/16-in. bolts into the footrest.

### FOOTREST ANGLE

You can adjust the angle of the footrest with a 3/16-in. hex wrench. See figure 9.

#### To adjust the footrest angle:

1. Turn the setscrew clockwise to raise the front of the footrest.
2. Turn the setscrew counter clockwise to lower the front of the footrest.

### FOOTREST DEPTH

The Jazzy 1103 uses a ball detent pin to fasten it to the power base. For your convenience, Pride also supplies a hex head bolt and Nylock nut. You can use this bolt and nut instead of the ball detent pin, for a more permanent fit.

#### To adjust the footrest depth:

1. Remove the ball detent pin from the footrest bracket.
2. Move the footrest in or out to the desired depth.
3. Reinstall the ball detent pin or the hex head bolt and nut (tighten with two 7/16-in. wrenches).

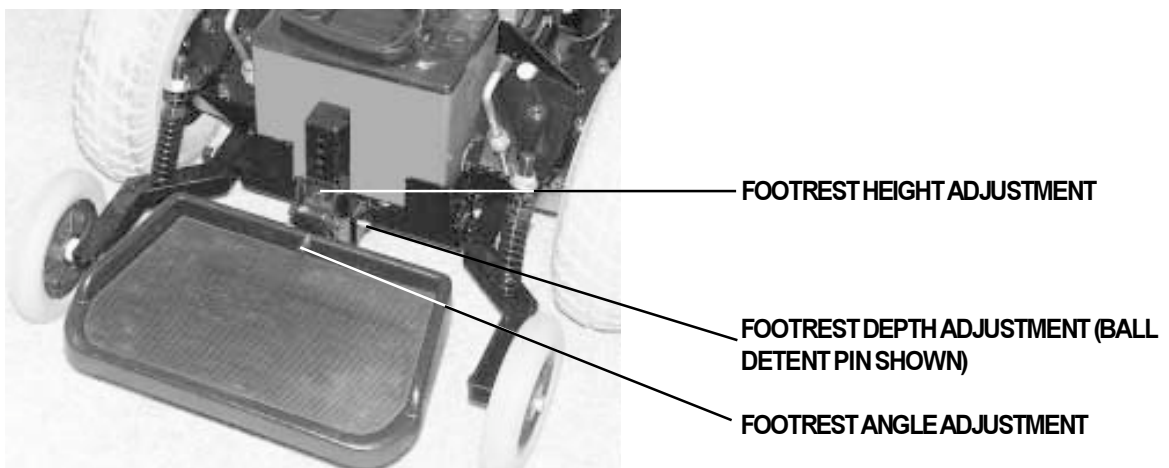

**FIGURE 9. Footrest Adjustment**

## IV. COMFORT ADJUSTMENTS

### ANTI-TIP WHEEL ADJUSTMENT



**WARNING: Consult your Pride provider before attempting to change the anti-tip wheel height! Changing the height affects handling under deceleration!**

The Jazzy 1103 mid-wheel drive design provides superior performance and safety. The anti-tip wheels are an integral part of this design because they provide you with stability during deceleration. The anti-tip wheels are preset at the factory to a height of 1.25 cm off the ground. This is the ideal setting for most Jazzy 1103 users. However, you may encounter situations where you may need to adjust the anti-tip wheels. For instance, if you drive your Jazzy on surfaces, such as deep pile carpeting, you may notice that the anti-tip wheels have a tendency to drag on the carpet. In this case, you may need to raise the anti-tip wheels. If you drive your Jazzy primarily on smooth surfaces, such as linoleum or tile, you may find that you are tipping forward more than is comfortable for you. (This may be more apparent for lighter users.) In this case, you may need to lower the anti-tip wheels.

**Required Tools:** 1/2-in. wrench, 5/32-in. hex wrench, 3/4-in. wrench

#### To adjust the anti-tip wheel height:

1. Remove the seat, body shroud, and the batteries. See III, “Operation” and V, “Disassembly.”
2. Locate the locking nut and setscrew on the anti-tip assembly. See figure 10.
3. Use a 1/2-in. wrench to loosen the locking nut.
4. Use a 5/32-in. hex wrench to turn the setscrew. Turn the setscrew clockwise to raise the anti-tip wheel. Turn the setscrew counterclockwise to lower the anti-tip wheel.
5. Tighten the locking nut.

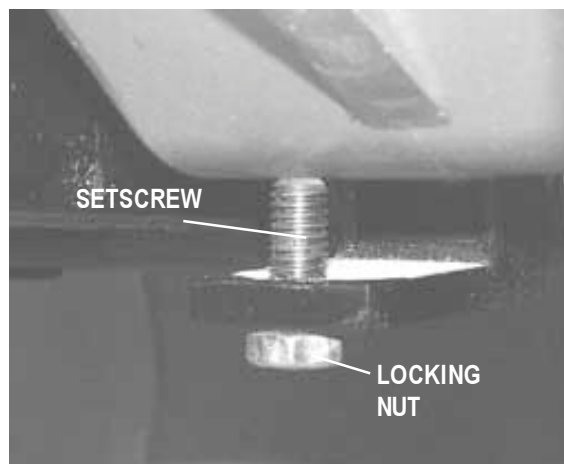

**FIGURE 10. Anti-tip Height Adjustment**

## V. DISASSEMBLY

### SEAT REMOVAL

You may wish to remove the seat to transport your Jazzy.

#### To remove the seat:

1. Turn the power off.
2. Make sure the Jazzy is not in freewheel.
3. Unplug main wire harness behind the seat.
4. Lift the seat up and out of the seat tower.

### BODY SHROUD REMOVAL

The body shroud is a one-piece molded plastic body that covers the power base frame. You must remove the body shroud in order to change the batteries and check the cable connections.

#### To remove the body shroud:

1. Turn the power off.
2. Make sure the Jazzy's motor is disengaged. See III, "Operation."
3. Unplug the controller wiring harness.
4. Remove the seat.
5. Lift the body shroud straight up. It should lift up easily.
6. Be sure to reengage the drive motors.

### BATTERY REMOVAL

To remove the batteries, see VI, "Care and Maintenance."

## VI. CARE AND MAINTENANCE

Your Jazzy is a sophisticated power chair. Like any motorized vehicle, it requires routine maintenance. You can perform some of these checks. Others require assistance from an authorized Pride provider. Preventive maintenance is very important. If you follow the maintenance checks in this section as scheduled, you can help ensure that your Jazzy gives you years of trouble-free operation. If you have any doubt as to your Jazzy's care or operation, contact your Pride provider.



**CAUTION: Your Jazzy 1103, like most electrical equipment, is susceptible to damage from the elements. Avoid damp areas of any kind. Direct exposure to water or dampness could cause the wheelchair to malfunction electronically and mechanically. Water can cause electrical components to corrode and the frame to rust.**

### Should your Jazzy 1103 come in contact with water:

1. Dry your Jazzy 1103 as much as possible with a dry towel.
2. Allow your Jazzy 1103 to sit in a warm, dry place for 24 hours to allow unseen water to evaporate.
3. Perform all safety and operational tests before using your Jazzy again.
4. If any inconsistencies are found, take your Jazzy 1103 to an authorized service center.

### TEMPERATURE

Some of the parts of your Jazzy 1103 are susceptible to extreme changes in temperature.

- In extremely cold temperatures the batteries may freeze. The specific temperature at which they freeze depends on a number of factors, such as battery charge, usage, and composition of the batteries (e.g., Sealed Lead Acid or Gel Cell).
- Temperatures above 50°C/122°F may cause the Jazzy 1103 to operate at a reduced speed. This is a safety feature built into the controller that helps prevent damage to the motor and other electrical components (see "Thermal Rollback" in III, "Operation").

### GENERAL GUIDELINES

- Avoid knocking or bumping your controller, especially the joystick.
- Avoid prolonged exposure of your Jazzy to extreme conditions such as heat, cold, or moisture.
- Keep the controller clean.
- Check all connections on the electronics connector housing to ensure that they are all tight and secured properly. Also check the charger harness connector.
- When the battery indicator gauge is completely lit, the batteries are fully charged and the controller and electrical system are OK.
- If one red bar on the battery indicator gauge is blinking slowly, the batteries are low and need to be charged, but the controller and electrical system are OK.
- If the battery indicator gauge is blinking rapidly, the controller has detected a fault in either its own circuits or in the Jazzy's circuits. (See III, "Operation".)

## VI. CARE AND MAINTENANCE

- Make sure the drive tyres are inflated to 30-35 psi.
- Use a rubber conditioner on the tyre sidewalls to help preserve them. Check the tyres for wear.
- The body shroud has been sprayed with a clear sealant coating. You can apply a light coat of car wax to help it retain its high-gloss appearance.
- Check all electrical connections. Make sure they are tight and are not corroded. Batteries must sit flat within the battery area, with the battery terminals facing inward towards each other. Refer to the frame decal for the correct wiring layout.
- All wheel bearings are pre-lubricated and sealed. They require no subsequent lubrication.

### DAILY CHECKS

- With the controller turned off, check the joystick. Make sure it is not bent or damaged and that it returns to center when you release it. Check the rubber boot around the base of the joystick for damage. Visually inspect the boot only. Do not handle or try to repair it. See your authorized service center if there is a problem.
- Visually inspect the controller harnesses. Make sure that they are not frayed or cut or have any wires exposed. See your authorized Pride provider if there is a problem with any of these harnesses.

### WEEKLY CHECKS

- Disconnect and inspect the controller and charger harnesses from the electronics connector housing. Look for corrosion. Contact your local Pride provider if necessary.
- Ensure that all parts of the controller system are securely fastened to your Jazzy. Do not overtighten any screws.
- Check for proper tyre inflation; there should be 30 - 35 psi in each tyre. If a tyre will not hold air, see an authorized Pride provider for replacement of the tube.
- Check the brakes. This test should be carried out on a level surface with at least 3 feet of clearance around your Jazzy.

#### To check the brakes:

*NOTE: The Jazzy may move when performing this test. Immediately release the joystick. You must be able to hear each electrical brake operating within a few seconds of joystick movement.*

1. Turn on the controller and turn down the speed control.
2. After 1 second, check the battery gauge. Make sure that it remains on.
3. Slowly push the joystick forward until you hear the electric brakes click.
4. Repeat this test three times, pushing the joystick backwards, left, and right.



## VI. CARE AND MAINTENANCE

### MONTHLY CHECKS

- Check that the anti-tip wheels are not rubbing the ground when you are operating the Jazzy. Adjust them as necessary. See IV, “Comfort Adjustments.”
- Check for extreme wear on the front anti-tip wheels. Replace them as necessary.
- Check for drive tyre wear. See an authorized Pride provider for repair.
- Check the rear casters for wear. Replace as necessary.
- Check the rear forks for damage or fluttering which indicates that they may need to be adjusted or the bearings may need to be replaced. See an authorized Pride provider for repair.
- Keep your Jazzy clean and free of foreign material, such as hair, food, drink, etc.

### YEARLY CHECKS

Take your Jazzy to an authorized Pride provider for yearly maintenance. This will help ensure that your Jazzy is functioning properly and help prevent future complications.

### STORAGE

Your wheelchair should be stored in a dry place free from temperature extremes. When storing, disconnect the batteries from the Jazzy. See III, “Operation” for complete instructions. If you fail to store the unit under the above conditions, the frame can rust and the electronics can be damaged.

### CLEANING INSTRUCTIONS

- Never hose off your Jazzy 1103 or place it in direct contact with water.
- Your Jazzy 1103 has a clear-coated ABS plastic body shroud that allows it to be easily wiped clean with a damp cloth. Never use any chemicals to clean a vinyl seat, as they may cause the seat to become slippery or dry out and crack. Use soapy water and dry the seat thoroughly.

### TYRES AND TUBES

If your Jazzy 1103 is equipped with pneumatic tyres, you should check the air pressure at least once a week. This prolongs the life of your tyres as well as helps ensure the perfect operation of your chair. If you have a flat tyre, replace the tube. Replacement tyres and tubes are readily available at the Pride provider location where you purchased your Jazzy 1103.



**WARNING: Completely deflate the tyre before attempting repair!**

#### Follow these easy steps for a quick and safe tube or tyre replacement:

1. Completely deflate the tyre (if pneumatic).
2. Use a 9/16-in. wrench to remove the nut from wheel axle.
3. Pull the wheel off of the axle.
4. Use a 1/2-in. socket and ratchet to remove the four bolts that hold the two-piece wheel together. The rim separates into two pieces.
5. Remove the old tube and/or tyre and replace with new tube or tyre.
6. Place the rim halves together and reinstall bolts.
7. Slide the wheel back onto the shaft and torque the nut to 16 ft.-lbs.
8. Inflate the tyre to 30-35 psi (if pneumatic).

# VI. CARE AND MAINTENANCE

## BATTERY REPLACEMENT

### To replace the battery:

1. Turn the power off.
2. Unplug the controller wire harness. See V, “Disassembly.”
3. Remove the seat.
4. Remove the body shroud.
5. Engage the motor drive assembly. See III, “Operation.”
6. Remove the 1/2-in. nuts and bolts that fasten the battery cables to the battery.
7. Install the new batteries into the Jazzy 1103 with the terminal sides of the batteries inward facing each other.
8. Connect the wire marked (+) to the closest positive (red) battery terminal.
9. Connect the wire marked (-) to the closest negative (black) battery terminal on the other battery.
10. Connect one circuit breaker harness to the empty positive terminal of one battery and the other circuit breaker harness to the empty negative terminal of the other battery.
11. Dispose of your old batteries in accordance with your local disposal laws.

## MOTOR BRUSHES

The electric motors that power your Jazzy use carbon brushes. These brushes may become susceptible to wear over a long period of time. The motor brushes are the two contacts located inside the motor assembly that supply power to the motor. They are designed to provide several thousand hours of operation. But if the brushes become dirty with carbon deposits or wear out, the motor will run poorly or not at all. We recommend that your authorized Pride provider inspect the brushes every six months, or sooner if your Jazzy 1103 runs poorly. If inspection determines excessive wear on the brushes, they must be replaced or motor damage will result.

*NOTE: Failure to maintain the brushes could void the Jazzy’s warranty.*

### To inspect or replace the motor brushes:

1. Remove the seat and body shroud. See V, “Disassembly.”
2. Unscrew the motor brush caps. See figure 13.
3. Remove the brushes.
4. Inspect for wear. See figure 14.
5. Replace the brushes, if necessary. Contact your local authorized Pride provider for replacement brushes.

## VI. CARE AND MAINTENANCE

### CORRECTIVE MAINTENANCE

If the battery indicator gauge does not light up:

- Check the harness connections. Make sure they are tight.
- Check the circuit breaker. Reset it if necessary.
- Check the battery connections.

If the above conditions prove normal, you can load test the batteries with a battery load tester. These testers are available at automotive parts stores. Disconnect both batteries before load testing and follow the directions that come with the load tester. If either one of the batteries fails the load test, replace both of them. If your Jazzy still does not power up, contact your local Pride provider.

### WHEN TO SEE YOUR PRIDE PROVIDER FOR SERVICE

The following symptoms could indicate a serious problem with your Jazzy. If necessary, contact an authorized Pride provider. When calling, have the model number, serial number, nature of the problem, and the trouble code if available.

- motor noise
- frayed harnesses
- cracked or broken connectors
- uneven wear on any of the tyres
- jerky motion
- pulling to one side
- bent or broken wheel assemblies
- does not power up
- powers up, but does not move



**FIGURE 13. Motor Brush Caps**

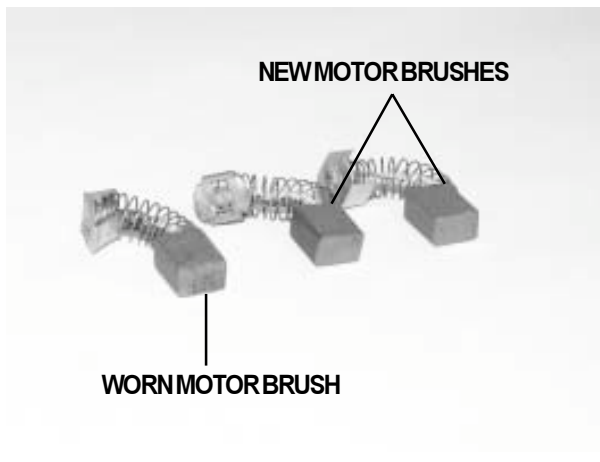

**FIGURE 14. Motor Brushes**

## VII. OPTIONAL ACCESSORIES

### POWER ELEVATING SEAT OPTION

Your Jazzy may be equipped with a power elevating seat option. This feature can enhance the capabilities of the Jazzy in several ways:

By elevating the seat, your level of reach is extended, to allow more freedom and independence in many environments.

You can easily adjust the Jazzy's seat height to any surface to which you want to transfer. The seat swivels 90 degrees to whichever side the joystick is located.

By raising your seat, you are closer to the eye level of standing persons. This provides better interaction.

For all the benefits your elevating seat can provide you, there are limitations. **The following precautions must be observed in order to assure safe use of the Jazzy elevating seat option.**

- Read and understand this owner's manual thoroughly before operating the Jazzy.
- The power seat option is intended for use on a **level surface only**.
- **Always** fasten the seat belt when operating the elevating seat. Your Jazzy's power elevating seat is equipped with a system that reduces the power chair's speed by one half whenever the seat is elevated more than 2.5-5 cm. Always check to be sure this system is operating properly before using your Jazzy.
- **Never** raise the seat from its lowest position on an inclined surface. Failure to heed this warning can result in the Jazzy tipping over and causing injury.
- **Never** raise the seat from its lowest position when operating your Jazzy on bumpy or uneven surfaces. Failure to heed this warning can result in the Jazzy tipping over and causing injury.
- **Operate** the Jazzy **only on a flat level surface** whenever the elevating seat is raised from its lowest position.
- **Never** raise the power elevating seat while your Jazzy is in the freewheel mode.

Your Jazzy power elevating seat can be activated by using the toggle switch located close to your joystick. See figure 15.

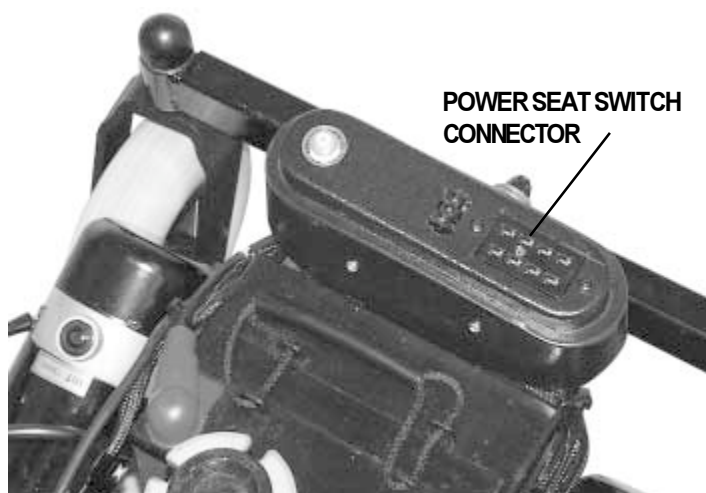

**FIGURE 15. Power Seat Toggle Switch**

## VII. OPTIONAL ACCESSORIES

Before activating your Jazzy power elevating seat, be sure you are on a flat level surface. To raise the power elevating seat, push the toggle switch forward. See figure 15. Releasing the toggle switch returns the switch to its center position and stops upward movement. To continue your lift, push the toggle switch forward again. Once the seat reaches its highest extension, the lift action stops; you should continue to hear and/or feel the lift motor running. This is because there is a clutch mechanism that allows the motor to continue running after the lift has reached its limit. This clutch works at both the top and bottom extensions of the lift. In order to prolong the life of your lift mechanism, please do not allow the motor to run more than a few seconds after the mechanism reaches the top or bottom limit. To return the seat to its lowest position, pull the toggle switch toward you. Releasing it stops the motor. When returning to the lowest position, always be sure that the mechanism has reached its lowest limit.

To use the swivel feature, locate the swivel lever under the seat. It is located on the opposite side of the joystick. Push down on the lever and the seat can be swiveled 90 degrees.



**FIGURE 16. Power Seat Connector Housing**



**FIGURE 17. Positioning Belt**

The following accessories are available from your local Pride provider.

### **POSITIONING BELT**

The positioning belt is designed to support your torso so that you do not slide down or forward in the seat. See figure 17.

- The positioning belt is not designed for use as a restraining device.
- Make sure the belt is secure but does not cause discomfort.



**CAUTION: The positioning belt is not designed for use as a seat belt in a motor vehicle. Nor is your Jazzy 1103 suitable for use as a seat in any vehicle. Anyone traveling in a vehicle should be properly belted into seats approved by the vehicle manufacturer.**

## VII. OPTIONAL ACCESSORIES

### **OXYGEN TANK HOLDER**

The removable oxygen tank holder is mounted to the back of the seat by means of the accessory bracket. See figure 18.

### **CANE AND CRUTCH HOLDER**

The removable cane and crutch holder is mounted to the back of the seat by means of the accessory bracket. See figure 19.

### **WALKER HOLDER**

The removable walker holder is mounted to the back of the seat by means of the accessory bracket. It can hold a standard size walker. See figure 20.

### **REAR BASKET**

The rear basket is mounted to the accessory bracket. It has a handle that you can use when you remove the basket from the Jazzy 1103. See figure 21.

### **CUP HOLDER**

The cup holder is mounted to the armrest. See figure 22.



**FIGURE 18. Oxygen Tank Holder**



**FIGURE 19. Cane and Crutch Holder**



**FIGURE 20. Walker Holder**



**FIGURE 21. Rear Basket**



**FIGURE 22. Cup Holder**

## VII. OPTIONAL ACCESSORIES

### **SWING-AWAY JOYSTICK BRACKET**

This option enables you to move the joystick from the front of the armrest to the side of the armrest without disconnecting it.

### **ELEVATING LEG RESTS**

Elevating Leg Rests (ELRs) provide the Jazzy with the ability to support each leg individually. Each ELR has a wide range of angle adjustments as well as a foot plate length.

### **SWING-AWAY LEG RESTS**

Swing-away Leg Rests provide the Jazzy with the ability to swing each leg rest to the side for an easier transfer.

### **SPECIALTY SEATING SYSTEMS**

Your Jazzy may be equipped with specialty seating or the Versa Seat. Please refer to the instructions that come with this seat.

### **ARMREST HEIGHT ADJUSTMENT**

Your Jazzy may be equipped with armrests that are adjustable in 1-inch increments.

#### **To change the armrest height:**

1. Remove the ball detent pin from the armrest.
2. Move the armrest up or down to the desired height.
3. Reinsert the ball detent pin.

## VIII. WARRANTY

### **LIFETIME LIMITED WARRANTY**

For the lifetime of your Jazzy 1103 from the date of purchase, Pride will repair or replace at our option, to the original purchaser, free of charge, any of the following parts found upon examination by an authorized representative of Pride to be defective in material and/or workmanship:

- Structural frame components

### **TWO-YEAR WARRANTY**

For two (2) years from the date of purchase, Pride will repair or replace at our option, to the original purchaser, free of charge, any of the following parts found upon examination by an authorized representative of Pride to be defective in material and/or workmanship:

- Electronics

### **EIGHTEEN-MONTH WARRANTY**

For eighteen (18) months from the date of purchase, Pride will repair or replace, at our option to the original purchaser, free of charge, any of the following parts found upon examination by an authorized representative of Pride to be defective in material and/or workmanship:

- Motor/gearbox assembly

### **WARRANTY EXCEPTIONS**

Motor: If damage occurs to the commutator of a motor as a result of not replacing the motor brushes after heavy wear to the brushes. Motor brushes are wear items and are not warranted.

Brake: One-year warranty for the electrical function of the brake. Brake pads are a wear item and are not warranted.

### **SIX-MONTH LIMITED WARRANTY**

For six (6) months from date of purchase, Pride will repair or replace, at our option, to the original purchaser, free of charge, any of the following parts found upon examination by an authorized representative of Pride to be defective in material and/or workmanship:

- Plastic components, except body
- Rubber components (except tyres and tubes)
- Bearings and bushings
- Casters and anti-tip wheels

Battery warranty is covered by the battery manufacturer. Battery warranty is not covered by Pride.



## VIII. WARRANTY

Warranty service can be performed by an authorized provider or by Pride. Do not return faulty parts to Pride without prior consent. All transportation costs and shipping damage incurred while submitting parts for repair or replacement are the responsibility of the original purchaser.

### WARRANTY EXCLUSIONS

- ABS plastic body shrouds and footrest covers are wear items and are not warranted.
- Batteries (battery manufacturer provides a six-month limited warranty)
- Tyres and tubes
- Upholstery and seating
- Repairs and/or modifications made to any part without specific consent from Pride.
- Circumstances beyond the control of Pride.
- Labor, service calls, shipping, and other charges incurred for repair of the product, unless specifically authorized by Pride.

### Damage caused by:

- Battery fluid spillage or leakage
- Abuse, misuse, accident, or negligence
- Improper operation, maintenance, or storage
- Commercial use or use other than normal

There is no other express warranty.

Implied warranties, including those of merchantability and fitness for a particular purpose, are limited to one (1) year from the date of purchase and to the extent permitted by law. Any and all implied warranties are excluded. This is the exclusive remedy. Liabilities for consequential damages under any and all warranties are excluded.

Some states do not allow limitations on how long an implied warranty lasts or do not allow the exclusion of limitation of incidental or consequential damages, so the above limitation or exclusion may not apply to you.

This warranty gives you specific rights, and you may also have other rights which vary from state to state.

Please fill out and return the warranty card to Pride. This assists Pride in providing the best possible Technical and Customer Service.