

Reliant Bath Lift (RBL250) Mounting Kit



Assembly, Installation and Operating Instructions

Kit No. 1085143

NOTE: Check all parts for shipping damage before using. In case of damage, DO NOT use. Contact the Dealer/Carrier for further instructions.

SAFETY SUMMARY

The following recommendations are made for the safe installation of the Mounting Kit on the Reliant Bath Lift (RBL250).

GENERAL WARNING

DO NOT assemble or use this kit without first reading and understanding this instruction sheet. If you are unable to understand the Warnings, Cautions or Instructions in this Instruction Sheet and in the Owner's Operating and Maintenance Manual (Part No. 1081003) provided with the Bath Lift, contact a healthcare professional, dealer or technical personnel before attempting to install this kit, otherwise, injury or damage may occur.

INSTALLATION WARNINGS

When installing or removing the Battery pack ALWAYS hold the battery pack firmly, otherwise injury or damage may result.

To prevent frame from tipping when raising or lowering the seat, either suction the frame to the floor or place one foot on the frame base when removing/installing the seat.

This kit contains the following:

DESCRIPTION	QTY
Suction Cups	2
End Plugs	4
Locking Clips	2
Rubber Pads	2
Instruction Sheet	1

REPLACING THE BATH LIFT MOUNTS

Removing the Bath Lift Seat (FIGURES 1-7)

NOTE: Refer to the GENERAL WARNINGS in the SAFTY SUMMARY of this Instruction Sheet.

1. Raise the Bath Lift seat by pressing the UP (↑) button on the pendant (FIGURE 1).

NOTE: The lift will automatically stop at the top and bottom limits if UP/DOWN buttons are not released.

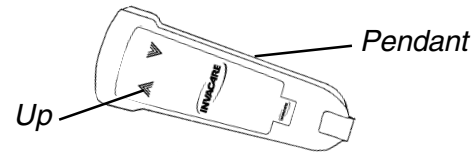

FIGURE 1 - RAISING THE BATH LIFT

2. Remove the battery pack by grasping the handgrip on battery pack and pulling upwards (FIGURE 2).

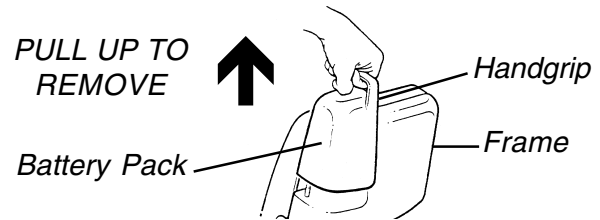

FIGURE 2 - REMOVING THE BATTERY PACK

3. To release the seat, press and hold the spring loaded chair release button (FIGURE 3).

WARNING

To prevent pinching injury between seat back and motor shroud when removing/installing the seat, DO NOT grasp seat anywhere other than at the recess at the top (FIGURE 3), the opening at the bottom of the seat or the lip where the battery pack was.

CAUTION

DO NOT remove the seat until the bath Lift is raised to the upper limit. Otherwise damage may occur.

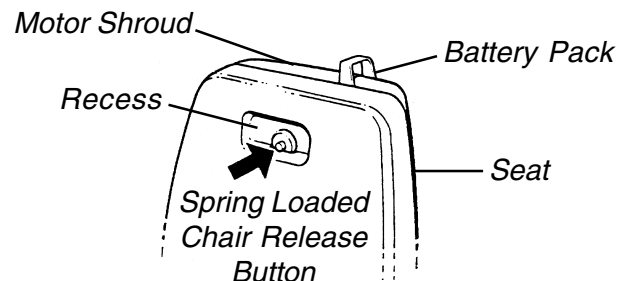

FIGURE 3 - RELEASING THE SEAT

4. While holding the spring loaded chair release button with one hand, grasp the seat bottom firmly with your other hand.
5. Lift the seat up until the slide block comes free of the grooves on the Bath Lift frame to remove the seat from the frame (FIGURE 4).

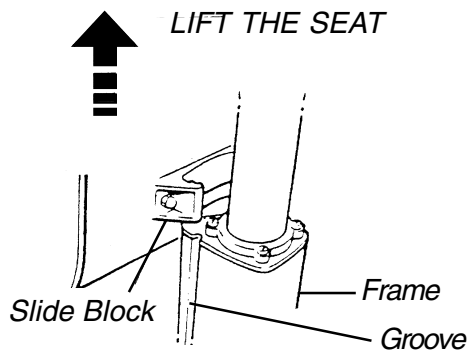

FIGURE 4 - REMOVING THE SEAT

6. Install the battery pack by grasping the handgrip and sliding the battery pack onto the charger connector on the frame (FIGURE 5).

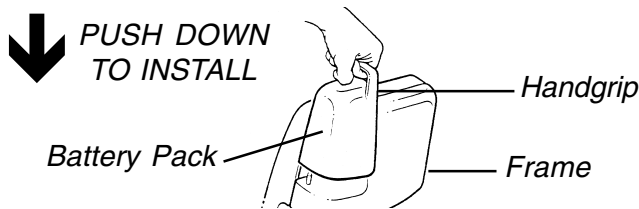

FIGURE 5 - INSTALLING THE BATTERY PACK

NOTE: The battery pack should fit snugly and not wobble.

7. Lower the Bath Lift by pressing the DOWN (↓) button on the pendant (FIGURE 6).

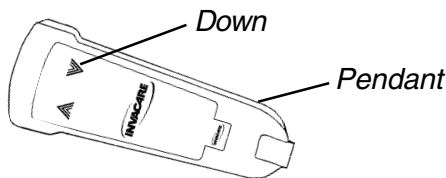

FIGURE 6 - LOWERING THE BATH LIFT

NOTE: The lift will automatically stop at the top and bottom limits if UP/DOWN buttons are not released.

8. Remove the battery pack by grasping the handgrip on battery pack and pulling upwards (FIGURE 7).

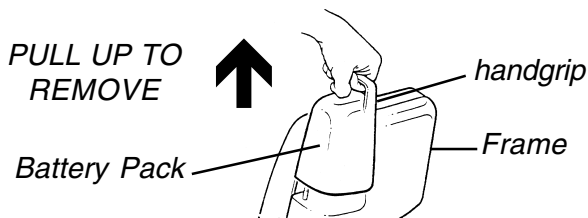

FIGURE 7 - REMOVING THE BATTERY PACK

REMOVING THE BATH LIFT FROM THE BATHTUB (FIGURE 8)

WARNING

Use proper lifting techniques to avoid injury. Keep back straight and bend knees when lifting components of the Bath Lift.

CAUTION

ALWAYS release suction cups from bathtub bottom BEFORE removing frame to prevent damage to the frame or bathtub.

1. Tilt the frame forward towards the drain or gently pull up on the suction cup loops to release the suction cups.
2. Remove frame from bathtub (FIGURE 8).

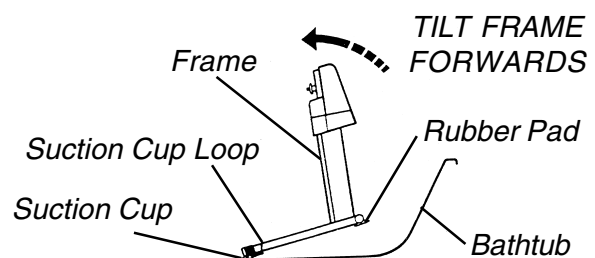

FIGURE 8 - REMOVING THE BATH LIFT FROM THE BATHTUB

REPLACING SUCTION CUPS (FIGURES 9-12)

1. Lean Bath Lift backwards so that the back of the frame is resting on the floor.

WARNING

Always point the screwdriver away from your body. Otherwise injury may occur.

2. Place screwdriver behind the lip of the EXISTING end plug (FIGURE 9).
3. Use a hammer to gently tap the back of the screwdriver until the EXISTING end plug comes free.

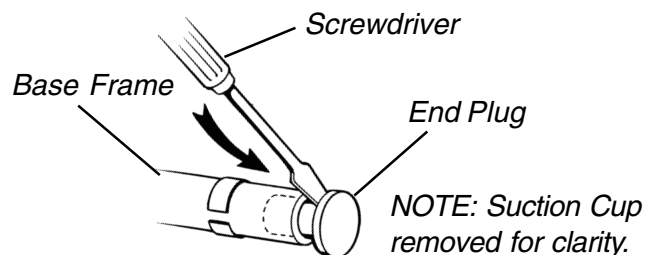

FIGURE 9 - REMOVING THE EXISTING END PLUG

- Twisting EXISTING suction cup from side, pull the suction cup off of the bath lift base frame (FIGURE 10).

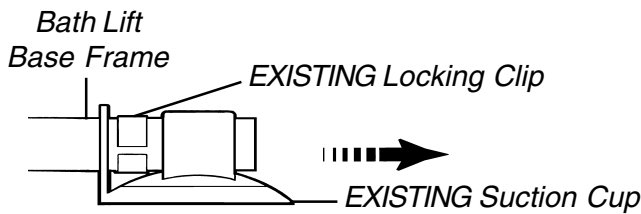

FIGURE 10 - REMOVING THE EXISTING SUCTION CUP

- Leave EXISTING locking clip on the bath lift base frame (it is glued in place).
- Install the NEW suction cup by reversing STEP 4.
- Place NEW end plug into the bath lift base frame and using a hammer gently tap the end plug securely into position (FIGURE 12).

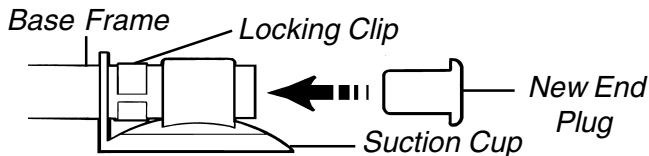

FIGURE 11 - INSTALLING END PLUG

- Repeat STEPS 2-7 on second suction cup.
- Tilt the Bath Lift forward so that it is resting in the upright position.
- Perform one (1) of the following:
 - Replace Rubber Pads, refer to REPLACING THE RUBER PADS in this instruction sheet.
 - Reinstall the Bath Lift into the bath tub, refer to INSTALLING THE BATHLIFT INTO THE BATH TUB in this instruction sheet.

REPLACING THE RUBBER PADS (FIGURES 12-14)

- Tilt Bath Lift forward so that it rests on the front portion of the frame and top edge of the top cover.

WARNING

Always point the screwdriver away from your body. Otherwise injury may occur.

- Place screwdriver behind the lip of the EXISTING end plug (FIGURE 12).
- Use a hammer to gently tap the back of the screwdriver until the EXISTING end plug comes free.

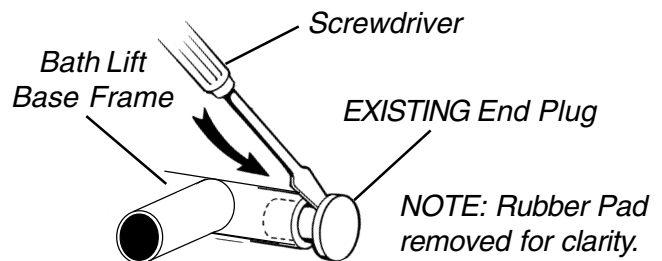

FIGURE 12 - REMOVING THE EXISTING END PLUG

- Twisting EXISTING Rubber Pad from side, pull the suction cup off of the bath lift base frame (FIGURE 13).

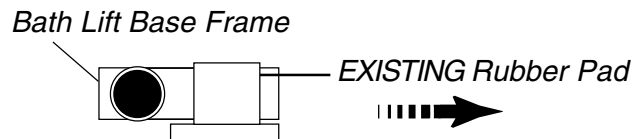

FIGURE 13 - REMOVING THE EXISTING RUBBER PAD

- Install the NEW rubber pad by reversing STEP 4.
- Place NEW end plug into the bath lift base frame and use a hammer to gently tap the end plug securely into position (FIGURE 14).

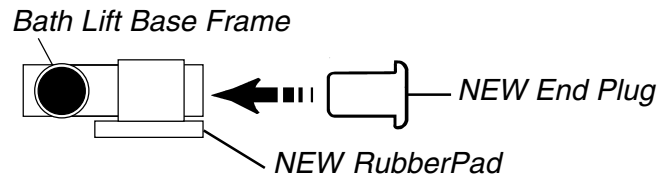

FIGURE 14 - INSTALLING END PLUG

- Repeat STEPS 2-6 on second rubber pad.
- Tilt the Bath Lift back to the upright position.
- Reinstall the Bath Lift into the bath tub, refer to INSTALLING THE BATHLIFT INTO THE BATH TUB in this instruction sheet.

INSTALLING THE BATH LIFT INTO THE BATHTUB (FIGURE 15)

NOTE: Refer to the GENERAL WARNINGS in the SAFETY SUMMARY of this Instruction Sheet.

- Clean tub and wipe suction cups with a damp cloth.
- Place the bath lift base frame in the bathtub (FIGURE 15).
- Position the rear pads of the frame just in front of the curve at the bottom of the back of the bath.

WARNING

Lifting column **MUST** be in lowest position **BEFORE** installing frame to prevent tipping. The frame should be placed into an **EMPTY** bathtub.

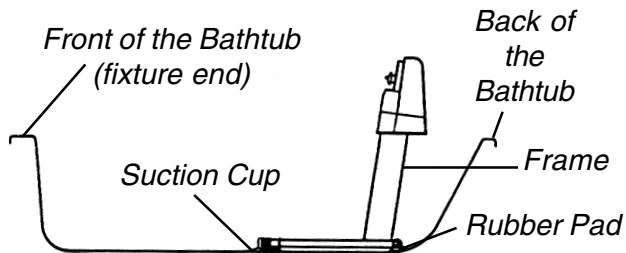

FIGURE 15 - INSTALLING THE BATH LIFT INTO THE BATH TUB

Reinstall Seat onto Bath Lift Frame (FIGURES 16-18)

NOTE: If necessary, reinstall the battery pack on the frame.

1. Raise the bath lift all the way up by pressing the UP (↑) button on the pendant (FIGURE 16).

NOTE: The lift will automatically stop at the top and bottom limits if UP/DOWN buttons are not released.

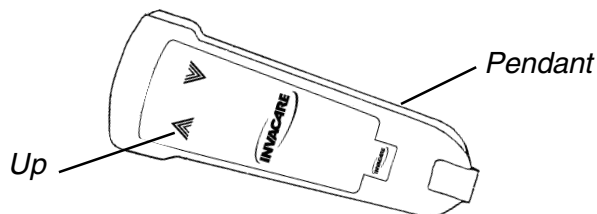

FIGURE 16 - RAISING THE BATH LIFT

2. Remove the battery pack by grasping the handgrip on battery pack and pull upwards (FIGURE 17).

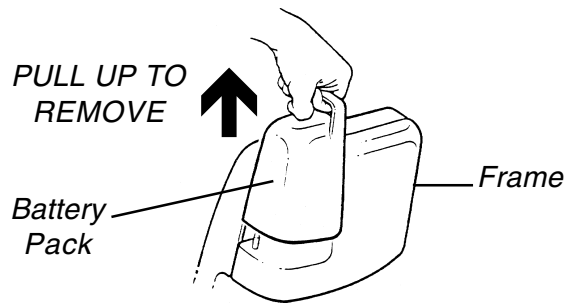

FIGURE 17 - REMOVING THE BATTERY PACK

3. Lower the seat onto the frame, ensuring that the slide block on the back of the chair slides down the two (2) grooves on the frame (FIGURE 18).

NOTE: The seat MUST be lowered onto the frame until the spring loaded chair release button locks in place and an audible "click" is heard.

4. Position the Bath Lift in the bath tub, refer to POSITIONING THE BATH LIFT FRAME IN BATH TUB in this Instruction Sheet

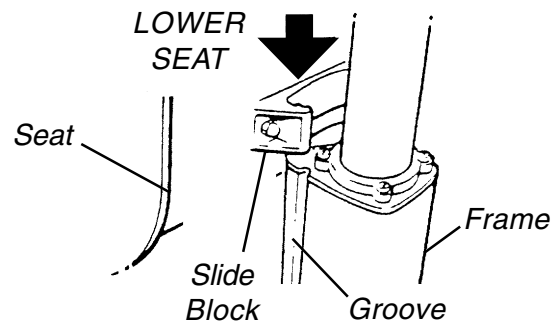

FIGURE 18 - INSTALLING THE SEAT

Positioning the Bath Lift Frame in the Bathtub (FIGURE 19)

1. Position the frame to align the line on the entry/exit side flap with the inside edge of the bathtub as shown in the FRONT VIEW of FIGURE 19.

WARNING

The frame must be positioned so that the side flap of the seat on the entry/exit side of the bathtub is fully supported by the side of the bathtub. The inside edge of the bathtub **MUST** be aligned with the line on this side flap.

2. Ensure the pads and suction cups are positioned flat on the bottom of the bathtub.
- NOTE: Pull up on suction cup loops to release suction cups from bathtub bottom.*
3. Press firmly down onto the two (2) front suction cups to attach the frame securely to the bottom of the bath.

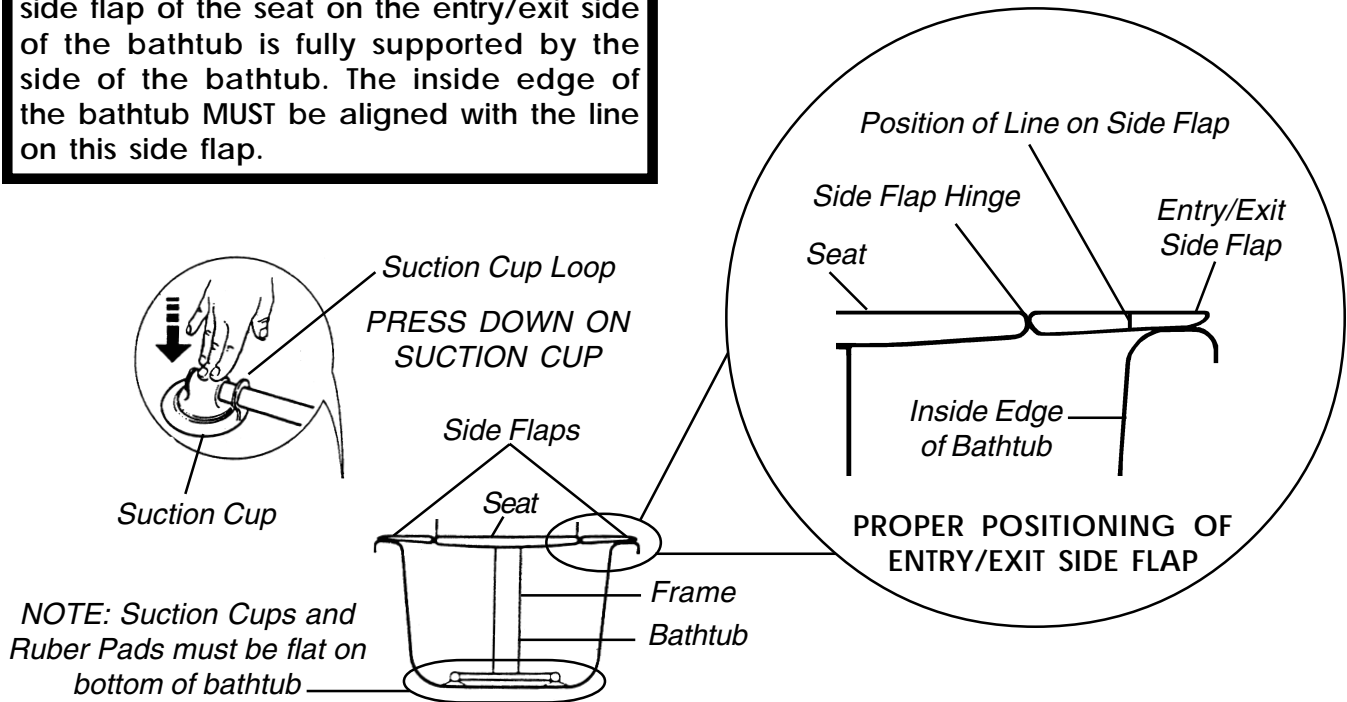

FIGURE 19 - POSITIONING THE BATH LIFT IN THE BATHTUB

LIMITED WARRANTY

PLEASE NOTE: THE WARRANTY BELOW HAS BEEN DRAFTED TO COMPLY WITH FEDERAL LAW APPLICABLE TO PRODUCTS MANUFACTURED AFTER JULY 4, 1975.

This warranty is extended only to the original purchaser/user of our products.

This warranty gives you specific legal rights and you may also have other legal rights which vary from state to state.

Invacare warrants the products manufactured to be free from defects in materials and workmanship for a period of one (1) year from the date of purchase. If within such warranty period any such product shall be proven to be defective, such product shall be repaired or replaced, at Invacare's option. This warranty does not include any labor or shipping charges incurred in replacement part installation or repair of any such product. Invacare's sole obligation and your exclusive remedy under this warranty shall be limited to such repair and/or replacement.

For warranty service, please contact the dealer from whom you purchased your Invacare product. In the event you do not receive satisfactory warranty service, please write directly to Invacare at the address on the back page, provide dealer's name, address, date of purchase, and indicate nature of the defect.

Invacare Corporation will issue a serialized return authorization. The defective unit or parts MUST be returned for warranty inspection using the serial number, when applicable as identification within 30 days of return authorization date. Do not return products to our factory without our prior consent. C.O.D. shipments will be refused; please prepay shipping charges.

LIMITATIONS AND EXCLUSIONS: THE FOREGOING WARRANTY SHALL NOT APPLY TO SERIAL NUMBERED PRODUCTS IF THE SERIAL NUMBER HAS BEEN REMOVED OR DEFACED, PRODUCTS SUBJECT TO NEGLIGENCE, ACCIDENT, IMPROPER OPERATION, MAINTENANCE OR STORAGE, PRODUCTS MODIFIED WITHOUT INVACARE'S EXPRESS WRITTEN CONSENT (INCLUDING, BUT NOT LIMITED TO, MODIFICATION THROUGH THE USE OF UNAUTHORIZED PARTS OR ATTACHMENTS; PRODUCTS DAMAGED BY REASON OF REPAIRS MADE TO ANY COMPONENT WITHOUT THE SPECIFIC CONSENT OF INVACARE, OR TO A PRODUCT DAMAGED BY CIRCUMSTANCES BEYOND INVACARE'S CONTROL, AND SUCH EVALUATION WILL BE SOLELY DETERMINED BY INVACARE. THE WARRANTY SHALL NOT APPLY TO PROBLEMS ARISING FROM NORMAL WEAR OR FAILURE TO ADHERE TO THE INSTRUCTIONS IN THIS MANUAL.

THE FOREGOING WARRANTY IS EXCLUSIVE AND IN LIEU OF ALL OTHER EXPRESS WARRANTIES. IMPLIED WARRANTIES, IF ANY, INCLUDING THE IMPLIED WARRANTIES OF MERCHANTABILITY AND FITNESS FOR A PARTICULAR PURPOSE, SHALL NOT EXTEND BEYOND THE DURATION OF THE EXPRESSED WARRANTY PROVIDED HEREIN AND THE REMEDY FOR VIOLATIONS OF ANY IMPLIED WARRANTY SHALL BE LIMITED TO REPAIR OR REPLACEMENT OF THE DEFECTIVE PRODUCT PURSUANT TO THE TERMS CONTAINED HEREIN. INVACARE SHALL NOT BE LIABLE FOR ANY CONSEQUENTIAL OR INCIDENTAL DAMAGES WHATSOEVER.

SOME STATES DO NOT ALLOW EXCLUSION OR LIMITATION OF INCIDENTAL OR CONSEQUENTIAL DAMAGE, OR LIMITATION ON HOW LONG AN IMPLIED WARRANTY LASTS, SO THE ABOVE EXCLUSIONS AND LIMITATIONS MAY NOT APPLY TO YOU.

THIS WARRANTY SHALL BE EXTENDED TO COMPLY WITH STATE OR PROVINCIAL LAWS AND REQUIREMENTS.



Invacare Corporation www.invacare.com

USA
One Invacare Way
Elyria, Ohio USA
44036-2125
800-333-6900

Invacare is a registered trademark of Invacare Corporation.
© 1999 Invacare Corporation

Form No. 98-328 Part No. 1085311 RevA (1)-1/00