

# LUMEX<sup>®</sup>

*Specialty Healthcare Seating*

A Graham-Field Brand



LUMEX



GRAHAM-FIELD

# THANK YOU FOR CHOOSING LUMEX!

Since 1946, Lumex® has been producing quality healthcare products for use in hospitals, long term care facilities, and the home. Lumex has been the innovator in Specialty Healthcare Seating. Often imitated, the Lumex line of Specialty Healthcare Seating continues to set the standard for durability, safety, patient comfort, and ease of use by caregivers.

All of our Specialty Healthcare Seating is backed by our Limited Wraparound Warranty:

- Frame: Lifetime Warranty
- Mechanical Components: Three Year Warranty
- Upholstered Components: One Year Warranty

Please see the GF Health Products, Inc. Warranty for complete details and limitations.

Lumex Specialty Healthcare Seating is designed for use in a variety of environments:

- Dialysis
- Oncology/Drug Delivery
- Ophthalmology
- OB/GYN Clinics
- Same Day Surgery
- Post-Operative Care
- Bariatric
- Outpatient Care
- Blood Collection
- Extended Care

Our wide selection of Healthcare Seating can help liberate almost anyone from the confines of bed and make them more comfortable for longer periods of time.

Our line of Clinical Recliners makes care, treatment, and recovery easier and more comfortable. We make our seating modifiable with options to meet special needs. We also make it easy to clean, easy to maintain, and easy to move. We offer recliners, chairs, and more in a variety of attractive styles, colors, and fabrics. And our range of price points ensures that these products fit as neatly into your budget as they do into your facility.

For the most up-to-date information on all G-F products, go to **[www.grahamfield.com](http://www.grahamfield.com)**.

# LUMEX

# LUMEX RECLINERS NOW DESIGNED, ENGINEERED, AND ASSEMBLED IN THE U.S.A.

Lumex Specialty Healthcare Seating is manufactured and assembled in our new state of the art facility in Jacksonville, Florida. This new facility allows Lumex the ability to offer you greater flexibility in color and fabric selection, improved quality combined with additional features and options.



## LUMEX CLINICAL CARE RECLINERS

All Lumex Clinical Care Recliners have built-in durability and versatility to meet the demanding needs of clinical and critical care use. Lumex Clinical Care Recliners have been designed with input from both patients and caregivers to provide the ultimate in safety, comfort and convenience.



## 48 COLORS AND PATTERNS

Our FR566, FR577 and FR587 Clinical Care Recliners are now available in a palette of 48 colors! As Interior Designers and Facility Managers play an increasing role in the selection of healthcare seating, the look, fit and finish of the seating used in facilities becomes an integral part of the selection process. Lumex now offers a wide variety of upholstery options and colors. From Sisal to Perriwinkle, Lumex Clinical Care Recliners will fit into any décor or designer specification! Lumex Clinical Care Recliners are available in:

**Patriot Plus: 20 Colors** in the “Upholstery Standard” of the Healthcare Industry.

**Savoy: 10 Colors** in a slightly softer hand upholstery.

**Renaissanc: 8 Colors** in a beautifully patterned upholstery.

**Silvertex: 10 Colors** that feature SILVERGUARD™ Silver Ion Technology.

Trim thread and welting all match the upholstery color for a smooth, polished look.

## SILVERGUARD® SILVER ION TECHNOLOGY!

Silvertex with SILVERGUARD Silver Ion Technology provides a natural, environmentally-friendly, germ-fighting defense to help safeguard against odor and stain-causing bacteria. Silvertex SILVERGUARD Silver Ion Technology is EPA registered and FDA approved. When combined with PERMABLOK3, it provides the ultimate performance solution.

## PERMABLOK<sup>3</sup>® PROTECTION!

All Lumex Specialty Healthcare Seating Upholstery features PERMABLOK<sup>3</sup> Advanced Vinyl Protective Coating. Engineered to create a tough effective barrier against the three biggest problems encountered in healthcare environments – germs, abrasion, and stains. You can't see it or feel it, yet the protection it offers results in extended product performance and lasting beauty with a minimum of care. It guards against the surface growth of fungus, mold and mildew spores, which can cause unpleasant odors, unsightly pink and black stains, and even allergic reactions.

All Lumex Upholstery Selections not only keep their good looks but also remain highly resistant to deterioration.

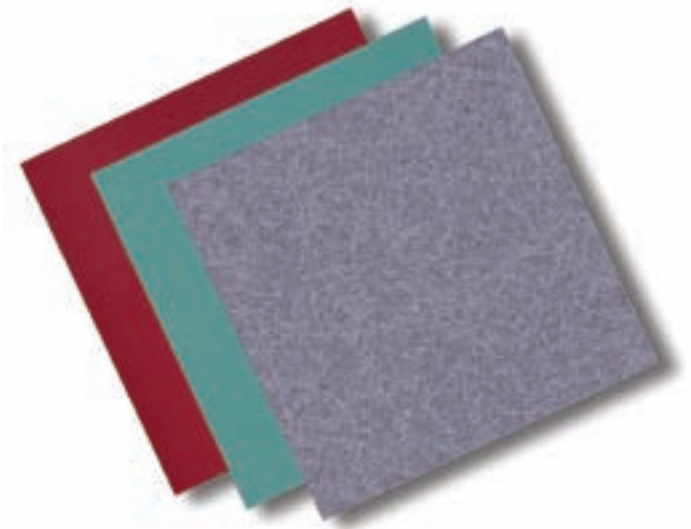

## HOW SILVERGUARD® WORKS!

Silver Ions destroy microorganisms by attaching to the bacteria's cell wall to disrupt protein metabolism within the cell. These are slowly released from their inorganic matrix in the presence of moisture. Simply stated—wipe down the upholstery with a damp cloth to activate the Silver Ions!

Silver encapsulates MRSA bacterium and it dies. SILVERGUARD is released as needed to effectively control bacterial growth, while leaving sufficient quantities of SILVERGUARD to retain antimicrobial protection.



48 COLORS NOW AVAILABLE ON FR566G, FR566DG, FR577RG & FR587W  
 CLINICAL CARE RECLINERS

Patriot Plus



PAT-427  
Blueridge\*



PAT-8504  
Sand

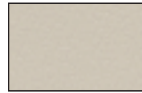

PAT-8602  
Oatmeal



TWI-851  
Doe Skin\*



PAT-8604  
Concrete



PAT-8567  
Dove



TWI-863  
Rosewood\*



PAT-8561  
Mulberry

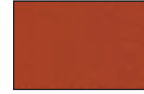

PAT-8611  
Terra Cotta



PAT-8615  
Berry

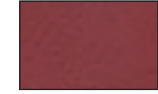

PAT-8533  
Port



PAT-8622  
Gray Moss



PAT-8624  
Granny Smith

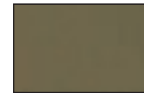

PAT-8626  
Eucalyptus



PAT-8584  
Taupe



PAT-8516  
Chestnut

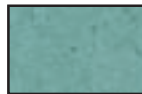

TWI-857  
Jade\*

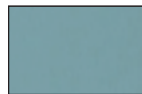

PAT-8628  
Sea



PAT-427  
Blueridge\*



PAT-454  
Royal Blue\*



PAT-432  
Imperial Blue\*

Savoy



SAV-401  
Vintage Gold\*



SAV-9711  
Tallow



SAV-409  
Warm Taupe\*



SAV-401  
Vintage Gold\*



SAV-9754  
Sisal



SAV-9757  
Turmeric



SAV-9701  
Bay Leaf



SAV-9722  
Desert Sage



SAV-9715  
Eucalyptus



SAV-9764  
Steel Grey



SAV-9728  
Navy

Renaissance



REN-9214  
Steel Blue



REN-9200  
Chalk



REN-9205  
Gypsum



REN-9203  
Pyrite



REN-9202  
Periwinkle



REN-9201  
Cobblestone



REN-9210  
Cypress



REN-9207  
Ice Blue

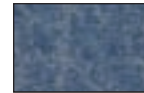

REN-9214  
Steel Blue

Silvertex

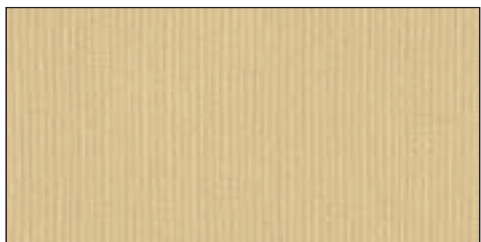

STX-8808  
Champagne



STX-8808  
Champagne



STX-8809  
Taupe



STX-8810  
Chestnut



STX-8814  
Umber



STX-8815  
Borscht



STX-8818  
Sage



STX-8819  
Celery



STX-8801  
Marine Blue



STX-8822  
Storm



STX-8805  
Jet



## ALL Lumex Clinical Care Recliners Meet CA TB133!

Safety is of primary importance in all healthcare facilities. All Lumex Clinical Care Recliners meet California Technical Bulletin 133 flammability standards. By utilizing a special flame-blocker material laminated directly onto the upholstery material, Lumex Clinical Care Recliners are not just made from "fire rated" material, but withstand the toughest fire test in use today for healthcare products.

The flexible flame-blocker material does not interfere with the comfort of the recliners because it is laminated directly to the upholstery.

The New Laminated Side Panels not only enhance the look and comfort of the recliner, but feature the same flame-blocker material!



## LIQUICELL PRESSURE REDUCTION TECHNOLOGY!

Lumex Clinical Care Recliners are equipped with LiquiCell. LiquiCell is an ultra-thin, liquid-filled interface specifically designed and proven to significantly reduce shear stress, aiding in the prevention of pressure sores and general discomfort.



## IMPROVED ARMREST PROFILE

Featuring specially-contoured high-density foam, the new armrest profile enhances patient comfort and support.



## SMOOTH SIDE TABLES!

To make cleaning and disinfecting easier, Lumex Clinical Care Recliners feature completely smooth side tables with no seams. The side tables also feature a rolled edge to ensure that prep materials stay in place and not trap contaminants. Side tables feature a simple-to-use mechanism that clearly indicates when table is in the locked position.



*Shown in down position*



*Shown in up position*

## ULTRAFLEX SUSPENSION SYSTEM—BUILT IN COMFORT!

Patient comfort is a key concern, particularly during long treatment sessions. Lumex Clinical Care Recliners utilize a unique suspension system featuring Ultraflex Tension Bands.

The FR566 Series of Clinical Care Recliners features a series of Ultraflex Tension Bands in the Lumbar Region that support specially contoured foam to ensure proper support and comfort.



# OPTIONAL HEAT AND MASSAGE

Our FR566, FR577 and FR587 Clinical Care Recliners are now available with Optional Heat and Massage. You want your patients to be as comfortable as possible before, during, and after treatment. One of the most common complaints from patients is that they feel cold during treatment. Lumex Clinical Care Recliners are now available with an optional Heat and Massage feature to help your patients stay warm and comfortable! Employing an easy-to-use single switch to independently control both the Heat and Massage feature, the switch is conveniently mounted on the right side of the recliner for easy access / use by both patient and caregiver.

Two heating elements, one in the seat and one in the back, provide gentle heat for the patient. Three Heat Settings allow patients to control just how much warmth they need. The heat feature has an automatic shut-off to help ensure that the patient is always in control of their comfort. Heat automatically shuts off after one hour of continuous use at the same level.

Many patients appreciate a gentle massage during treatment. The massage function offers a four massage settings that control the intensity and location of the massage to ensure that the patient receives the most appropriate level of massage. Massage automatically shuts off after fifteen minutes of continuous use at the same level. The Heat and Massage Option is powered by a low-voltage transformer with an eight-foot hospital-grade 120V cord. The Lumex Heat and Massage Unit meets UL60601-1 Standards for electric medical devices.



Massage motor

Massage motor locations

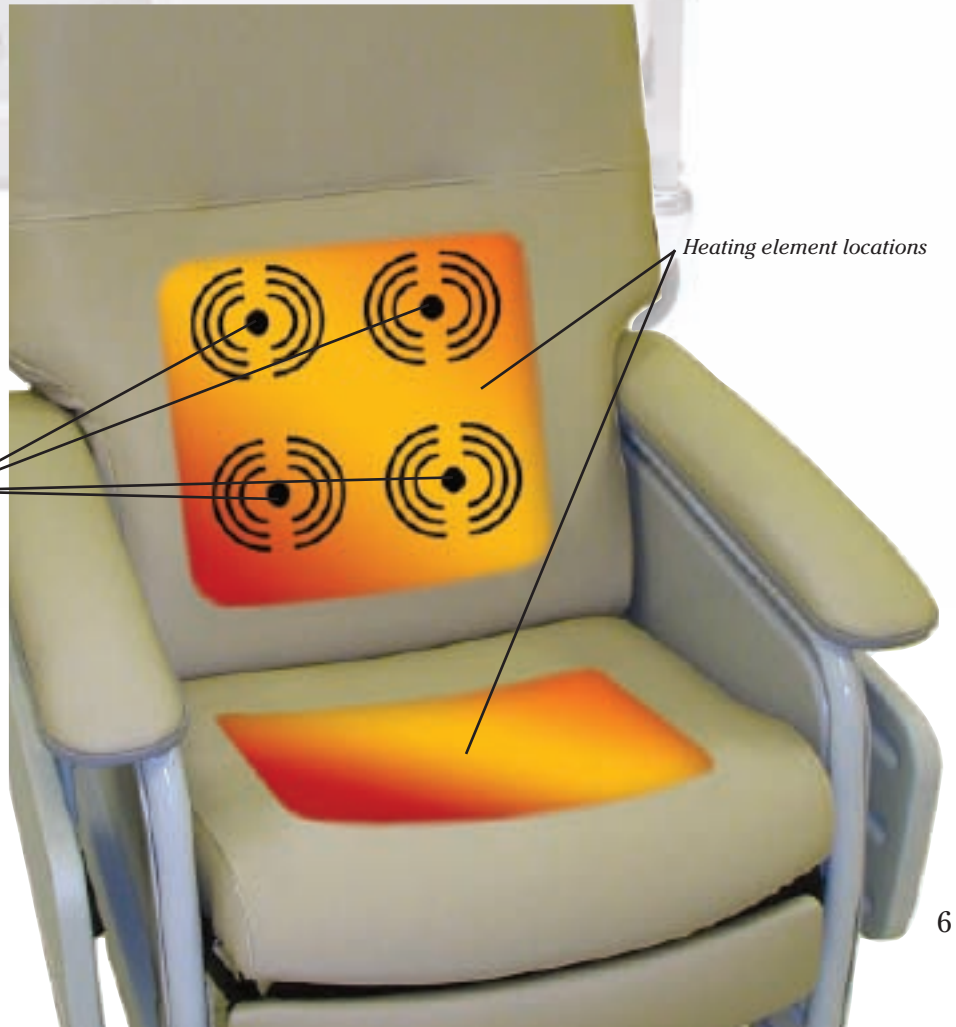



CLINICAL CARE RECLINERS



4 Fabric styles and 48 colors.

Higher density, softer foam for greater comfort.

Upholstered inside panels

Smooth tabs with no-seam, tapered edge.

# LUMEX FR566G CLINICAL CARE

The Lumex Deluxe Clinical Care Recliner sets a new standard of comfort for the patient and ease of use for the caregiver. The Lumex Deluxe Clinical Care Recliner is EXTRAordinary in many ways:

- ❑ The unique patent pending recline mechanism enables the patient to position the back from TV position to full recline. The wide, contoured seat and back, along with an integrated footrest, provide an enhanced level of comfort. Built-in arm pads in the back give improved support for the arms while in Trendelenburg. Wall saver armrest caps increase durability of the armrests and protect walls from marring.
- ❑ Higher floor to back height enables the caregiver to raise the patient up with less effort, reducing the chance for a back injury.
- ❑ Extra deep Trendelenburg position—steeper angle improves patient stabilization.
- ❑ Four Tente® swivel casters facilitate transport and maneuverability in confined areas. Left and right rear top-locking casters provide positive lock. Directional wheel lock on right rear caster reduces “crabbing” of recliner and enables the chair to be moved down hallways with less effort.
- ❑ Durable, high-impact side tables sit flush with chair arm to conveniently hold prep materials. Easy to actuate by caregiver.
- ❑ Extra heavy duty recliner mechanism.
- ❑ Weight bearing capacity: 350 Pounds.



*Vinyl covered side panels*



*Easy to achieve Trendelenburg position. No more cables or handles, Trendelenburg position can be actuated from either side of the recliner by a convenient foot pedal.*

**PERMABLOK<sup>3</sup>**  
ADVANCED VINYL PROTECTION

Features **LIQUICELL**® Technology

*Easily removed “pop-out” side panels enable easy access to recliner for cleaning and maintenance.*



*Multiple Positions for Enhanced Patient Comfort*



## LUMEX FR566DG CLINICAL CARE

- ❑ Innovative, easy to actuate drop-arm feature. Self-storing, dual drop-arms are simple for the caregiver to activate and enables a safer, easier lateral transfer for the resident and caregiver.
- ❑ The unique recline mechanism enables the patient to position the back from TV position to full recline. The wide, contoured seat and back, along with an integrated footrest provide an enhanced level of comfort. Built-in arm pads in the back give improved support for the arms while in Trendelenburg. Wall saver armrest caps increase durability of the armrests and protect walls from marring.
- ❑ Easy to achieve Trendelenburg position. No more cables or handles, Trendelenburg position can be actuated from either side of recliner by a convenient foot pedal. Higher floor to back height enables the caregiver to raise the patient up with less effort reducing the chance for a back injury.
- ❑ Extra deep Trendelenburg position—steeper angle improves patient stabilization.
- ❑ Easily removed “pop-out” side panels enable easy access to recliner for cleaning and maintenance.
- ❑ Four Tente® swivel casters facilitate transport and maneuverability in confined areas. Left and right rear top-locking casters provide positive lock. Directional wheel lock on right rear caster reduces “crabbing” of recliner and enables the chair to be moved down hallways with less effort.
- ❑ Durable, high-impact side tables sit flush with chair arm to conveniently hold prep materials. Easy to actuate by caregiver.
- ❑ Extra heavy duty recliner mechanism.
- ❑ Weight bearing capacity: 350 Pounds.



**PERMABLOK<sup>3</sup>**  
ADVANCED VINYL PROTECTION

Features  **LIQUICELL<sup>®</sup>** Technology

*Multiple Positions for Enhanced Patient Comfort*



# Lumex FR577RG Clinical Care

- ❑ Welded steel frame is constructed of round tubing resulting in improved structural integrity of the frame.
- ❑ Improved wider and softer armrest for patient comfort.
- ❑ Softer seat and back package for improved patient comfort. Varied density seat back and redesigned seating position provides excellent comfort and support during long term sitting.
- ❑ Easy to activate gas cylinder mechanism for quick Trendelenburg activation and improved lift.
- ❑ Durable, high impact side tables sit flush with chair arm to conveniently hold prep materials. Easy to actuate by caregiver.
- ❑ Easily removed “pop-out” side panels enable easy access to recliner for cleaning and maintenance.
- ❑ Three-position, plus Trendelenburg.
- ❑ Four Tente® swivel casters facilitate transport and maneuverability in confined areas. Left and right rear top-locking casters provide positive lock. Directional wheel lock on right rear caster reduces “crabbing” of recliner and enables the chair to be moved down hallways with less effort.
- ❑ Weight Bearing Capacity: 290 Pounds.



CLINICAL CARE RECLINERS

**PERMABLOK<sup>3</sup>**  
ADVANCED VINYL PROTECTION

Features **LIQUICELL**® Technology

**BACK PROFILE: FR577**  
Featuring specially-contoured high-density foam, the new back profile enhances patient comfort and support.



*Infinite Position Back Design*



## LUMEX EXTRA-WIDE CLINICAL CARE RECLINER FR587W

The Lumex Extra-Wide Clinical Care Recliner has been designed specifically for the larger resident/patient. The extra-wide seat width of 24" and greater weight bearing capacity enables the recliner to comfortably sit and position patients up to 450 pounds.

- ❑ Dual gas cylinders give smooth power assistance for back position adjustment and Trendelenburg activation.
- ❑ Ergonomically designed padded armrests for added patient comfort.
- ❑ Four Tente® swivel casters facilitate transport and maneuverability in confined areas. Left and right rear top-locking casters provide positive lock. Directional wheel lock on right rear caster reduces “crabbing” of recliner and enables the chair to be moved down hallways with less effort.
- ❑ Durable, high-impact side tables sit flush with chair arm to conveniently hold prep materials. Easy to actuate by caregiver.
- ❑ Weight bearing capacity: 450 Pounds.



**PERMABLOK<sup>3</sup>**  
ADVANCED VINYL PROTECTION

Features **LIQUICELL**® Technology

*Infinite Position Back Design*



## LUMEX ELECTRIC BARIATRIC CLINICAL CARE RECLINER FR588W

The Lumex Electric Bariatric Recliner is the perfect solution for larger patients who require a wider chair. Composed of a heavy gauge steel frame, this chair has a maximum weight capacity of 700 pounds! A four-function hand pendant activates the motor, allowing caregivers to safely recline and raise patients without strain.

- ❑ Quick-release trigger mechanism on push handle allows chair to swiftly move into Trendelenburg position.
- ❑ Fully equipped with rechargeable battery pack for full operation away from a wall outlet.
- ❑ Four swivel casters facilitate transport and maneuverability in confined areas.
- ❑ Durable, high impact side tables sit flush with chair arm to conveniently hold prep materials. Easy to activate by caregiver.
- ❑ Legrest and backrest raise and lower independently, giving the operator complete control over positioning.
- ❑ Comes complete with attaching head pillow for extra support and added comfort.
- ❑ Limited lifetime warranty on frame.
- ❑ One year warranty on electronics.
- ❑ Three years warranty on all other components.
- ❑ Weight bearing capacity: 700 Pounds.



Features  LIQUIGELL® Technology

The AEGIS Microbe Shield used on Lumex Long Term Care and Patient Room Seating works by chemically bonding itself to the treated surface and rupturing the membranes of any bacteria that it comes in contact with which inhibits the growth and spread of microbial growth.

Available in Four Designer Colors



Blue Ridge (427)

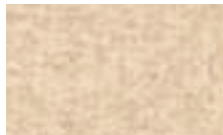

Doe Skin (851)



Jade (857)



Rosewood (863)

## CLINICAL CARE RECLINERS ACCESSORIES

### Leg Extensions 5699G

- Fits FR566G, FR577RG, and FR587W
- Fits all round tube frame designs.
- Adds 5" to height of recliner.
- Set of four extension legs.



### IV Pole Attachment 5782RG

- Offers a tip-free means of administering enteral feedings or IV therapy.
- For use on most Lumex Ortho-Biotic Seating with Lumex Bed Socket IV Pole (Model 2101A) sold separately.



### Universal Head Pillow FR5658

- Easy-on hook and loop attachment, the Universal Head Pillow can be easily positioned for individualized patient comfort.
- Fits on almost every model of recliner.

Vintage Gold	FR5658401
Warm Taupe	FR5658409
Blue Ridge	FR5658427
Imperial Blue	FR5658432
Royal Blue	FR5658454
Doe Skin	FR5658851
Jade	FR5658857
Rosewood	FR5658863

*Refer to page 17 to view colors.*

# SHIPPING CARTONS

All Lumex Clinical Care Recliners are now shipped in specially-designed cartons to reduce shipping damage. Casters come pre-installed. Tool-free assembly of recliners is quick and easy. Assembly instructions are included with every recliner.



*Back-saver design makes unpacking easier by reducing lifting.*



CLINICAL CARE RECLINERS





CLINICAL CARE RECLINERS





**Folding Set Up Screens**

Sets up in minutes to afford individual privacy. Vinyl reinforced panels with heat-sealed hems on snap-out rods, lightweight aluminum hinged tubing frame. Use with casters (included) or easily convert to tipped leg bases (included). Base allows screen to extend to full width and adjusts for multiple configurations. Easily dismantled for storage. White panels are 27.5" x 56".

- 4297W Three-section screen
- 4298W Four-section screen
- 4299C Replacement casters, set of 4
- 4299W Replacement white panel



**Labtron® Wallmax™ Aneroid Sphygmomanometer**

Large, 6" easy-to-read gauge is attached to a 110° swivel wall mounting bracket. Accumax™ cuff includes 8' coiled tubing. Cuff can be stored behind gauge.

- 222 Adult Blue
- V222B Adult Latex-Free Black Cuff and Faceplate
- CR222 Replacement Crystal Faceplate



**Labtron® Palm Aneroid Sphygmomanometer**

Durable, aluminum manometer with large, easy-to-read 65 mm dial. Integral latex-free, ribbed inflation bulb with dust filter. Deluxe push-button air release valve. Rotating bulb and valve provide ambidextrous use. Nylon cuff and latex-free one-tube bladder. Deluxe nylon carry case. Twenty year calibration warranty

- 215 Adult Grey
- 215C Child Grey
- 215X Large Adult Grey
- 216 Adult Orange

**Labtron® Mobile Aneroid Sphygmomanometer**

This mobile, height-adjustable aneroid sphygmomanometer features a large, 6" easy-to-read gauge mounted on a tip-resistant 5-wheel base. Accumax™ cuff includes 8' coiled tubing. Cuff can be stored behind gauge.

- 223B Adult Black
- V223 Adult Black Latex-Free



**Deluxe Revolving Stool With Foot Ring**

Durable, 4" foam-padded, 14.5" diameter vinyl seat on ruggedly constructed tubular chrome-plated steel frame. Large base spread provides added stability. Footrest ring for comfort. Height adjustment 17.5" to 27.5".

- 1834 B Black seat
- 1834 C Casters for 1834B, set of 4



**Heavy-Duty Footstool**

- Rugged, welded, chrome-plated steel construction.
- Non-tip design.
- Platform topped with non-skid, ribbed mat.
- Equipped with reinforced rubber tips.
- 9.5"H x 15"W x 16"D
- Weight capacity 350 lb.

GF1841-2 2/cs

**Safety Step-Up Stool**

- Attractive chrome-plated finish.
- Non-tip design.
- Features 35"-high handle platform and steel-reinforced rubber tips.
- Non-skid, ribbed rubber mat.
- 9.5"H x 15"W x 17"D
- Weight capacity 250 lb.

GF1840C-2 2/cs



**Stainless Steel Stethoscope**

The stainless steel dual head chestpiece has a non-chill ring for patient comfort. The internal spring binaural ensures acoustic sensitivity. 22" latex-free tubing keeps acoustics intact, even in the noisiest settings. Comes complete with two pair of contoured eartips. Lifetime warranty.

- LAB-7100 Black, Adult
- LAB-7100GY Grey, Adult
- LAB-7200 Black, Pediatric
- LAB-7300 Black, Infant
- LAB-7300GY Grey, Infant



LONG TERM CARE/PATIENT ROOM SEATING

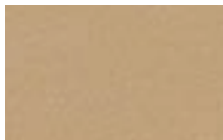

Vintage Gold (401)

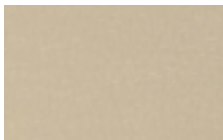

Warm Taupe (409)

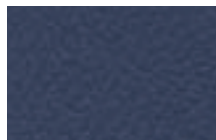

Blue Ridge (427)

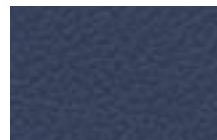

Imperial Blue (432)

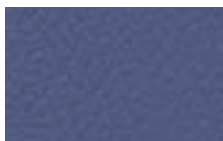

Royal Blue (454)

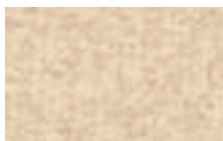

Doe Skin (851)

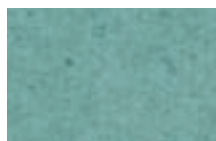

Jade (857)



Rosewood (863)



The AEGIS Microbe Shield used on Lumex Long TermCare and Patient Room Seating works by chemically bonding itself to the treated surface and rupturing the membranes of any bacteria that it comes in contact with which inhibits the growth and spread of microbial growth.

# DROP-ARM RECLINERS

## Lumex Drop-Arm Recliners FR3302

- Pillow back, three-positions, fire-rated upholstery.
- Combines the therapeutic benefits of position change with a more residential appearance. Designed to aid in circulation and to help ease discomfort from respiratory, heart and other ailments.
- Unique drop-arm mechanism facilitates lateral transfers. Easy to activate by caregiver.
- Ideal for knee and hip surgery patients.
- Three inch ball bearing casters ensure smooth transport; foot actuated swivel locking rear casters for a more secure lock.
- Unitized welded steel frame for durability. Flame and stain resistant vinyl upholstery available in a variety of colors.
- Weight Bearing Capacity: 250 Pounds.
  
- Four Fire Rated Upholstery Models are Available (Meets California Technical Bulletin 133 Flammability Standards)**

## Lumex Wrap-Around Warranty

1. Welded Frame: Limited Lifetime
2. Upholstery: Limited One Year
3. All Other Components:  
Limited Three Year

## Available Colors:

- Blue Ridge FR3302427
- Doe Skin FR3302851
- Jade FR3302857
- Rosewood FR3302863

Refer to page 15 to view colors.

## Lumex Drop Arm Recliner Accessories

- Anti-Tip Wheels 3306**  
One pair
- Tray Table 331000**



Anti-Tip Wheels 3306



Tray Table 331000

## THREE POSITION RECLINERS

### Lumex Three Position Recliner 574G

- ❑ The Standard of the Industry and the recliner that started it all! This first recliner specifically designed to improve the comfort and mobility of residents in extended care facilities. The Lumex Three Position Recliner easily adjusts into any one of three positions: sitting, TV or full recline. Recliners offer numerous therapeutic benefits including position changes that can aid in circulation and ease discomfort from respiratory, heart and other ailments.
- ❑ A position lock allows only the caregiver to secure the chair in any one of the three easily attained positions. Recliner encourages natural relaxation and improved blood circulation.
- ❑ Flex-o-Lator seat support system increases comfort by reducing the risk of "bottoming out".
- ❑ Ergonomically designed seat and back with varied density foam construction provides correct support. Articulating headrest quickly adjusts to maximize individual comfort requirements.
- ❑ For safer, easier transport, the Lumex Three Position Recliner features two four-inch swivel casters with wheel locks and four-inch fixed front wheels.
- ❑ The molded activity table can be fixed in position or left unsecured for easy exit from the recliner.
- ❑ Durable welded steel epoxy coated frame is easy to clean and maintain.
- ❑ Weight Bearing Capacity: 250 pounds.



### Warranty

1. Frame: Limited 2 Years
2. Upholstery: Limited 1 Year
3. All Other Components: Limited 1 Year



Side Bolsters 599G

### Available Colors:

Vintage Gold	574G401
Warm Taupe	574G409
Blue Ridge	574G427
Imperial Blue	574G432
Royal Blue	574G454
Doe Skin	574G851
Jade	574G857
Rosewood	574G863

### Fire Rated Colors

Meets California Technical Bulletin 133

### Flammability Standards

Vintage Gold	FR574G401
Warm Taupe	FR574G409
Blue Ridge	FR574G427
Imperial Blue	FR574G432
Royal Blue	FR574G454
Doe Skin	FR574G851
Jade	FR574G857
Rosewood	FR574G863

# PREFERRED CARE® RECLINERS SERIES

The Lumex Preferred Care Recliner Series offers facilities the widest selection of sizes and features of any specialty healthcare seating. When it comes to quality care, one size does not fit all and proper fit is an important consideration. Lumex Preferred Care Recliners are available in regular and extra-wide versions. Based upon the original 565G, the 565WG offers the same features scaled to accommodate the resident's unique proportions.

## Standard Features on all Lumex Preferred Care Recliners:

- ❑ Infinite recliner back patented mechanism provides infinite positioning of the back, ranging from 95 degrees to 145 degrees for increased resident comfort and pressure relief. The reclining back can be locked in any position by the caregiver.
- ❑ A unique suspension system self-adjusts to each person, cradling the resident from head to heel and virtually eliminating the risk of "bottoming out".
- ❑ Extra-wide padded armrests and side panels maximize comfort.
- ❑ Durable epoxy coated welded steel frame is easy to clean and maintain.
- ❑ Quick-release upholstery allows for easy cleaning, removal and replacements. Vinyl upholstered back is sulfide stain, mildew and oil resistant.
- ❑ A variety of accessories are available to customize the chair for specific individual needs.
- ❑ Lumex Wrap-Around Warranty
  1. Welded Frame: Limited Lifetime
  2. Upholstery: Limited One Year
  3. All Other Components: Limited Three Year
- ❑ Weight Bearing Capacity:
  1. 565G, 565TG, and 565DG: 250 lb.
  2. 565WG: 400 lb.



565DG



565G



565WG



565TG



## PREFERRED CARE® RECLINERS SERIES

### Lumex® Preferred Care® Recliner 565G

The Lumex 565 Patented recline mechanism allows for infinite positioning of recline. Reduced armrest and seat height enables the recliner to fit under dining/activity tables and allows resident to “scoot” and more easily reposition chair by themselves.

Two swivel casters with two rear locking casters enable the Preferred Care Recliner to be easily maneuvered in small spaces and moved down hallways.

*Shown With Optional Accessories.*

#### Available Colors:

Vintage Gold	565G401
Warm Taupe	565G409
Blue Ridge	565G427
Imperial Blue	565G432
Doe Skin	565G851
Jade	565G857
Rosewood	565G863

#### Fire Rated Colors

**Meets California Technical Bulletin 133  
Flammability Standards**

Blue Ridge	FR565G427
Jade	FR565G857
Rosewood	FR565G863

*Refer to page 17 to view colors.*



565G

### Lumex® Extra-Wide Preferred Care® Recliner 565WG

All of the features and benefits of the Lumex Preferred Care Recliner in an extra-wide width. The 24" width is ideal for residents who require a wider seat width. Directional wheel lock on right rear caster reduces “crabbing” of recliner and enables the chair to be moved down hallways with less effort.

Weight bearing capacity: 400 lb.

#### Available Colors:

Vintage Gold	565WG401
Warm Taupe	565WG409
Blue Ridge	565WG427
Imperial Blue	565WG432
Doe Skin	565WG851
Jade	565WG857
Rosewood	565WG863

#### Fire Rated Colors

**Meets California Technical Bulletin 133  
Flammability Standards**

Blue Ridge	FR565WG427
Jade	FR565WG857
Rosewood	FR565WG863

*Refer to page 17 to view colors.*



*Standard anti-tippers*

565WG

## Preferred Care® Recliners Series

### Lumex Tilt-in-Space Preferred Care Recliner 565TG

All of the features and benefits of the Lumex Preferred Care Recliner plus – Tilt-in-Space feature. The Tilt-in-Space feature allows for the infinite positioning of the resident, improves resident positioning, and increases comfort and pressure relief. Independent leg rest is easily activated by the caregiver from side of chair to provide leg elevation for increased resident comfort. Self storing, height adjustable drop arm is simple for the caregiver to activate and enables a safer, easier lateral transfer for the caregiver and resident. Padded armrests provide a soft surface for added resident comfort. Directional wheel lock on right rear caster reduces “crabbing” of recliner and enables the chair to be moved down hallways with less effort.

#### Available Colors:

Blue Ridge 565TG427  
Doe Skin 565TG851  
Jade 565TG857  
Rosewood 565TG863

#### Fire Rated Colors

**Meets California Technical  
Bulletin 133 Flammability  
Standards**

Blue Ridge FR565TG427  
Jade FR565TG857  
Rosewood FR565TG863

*Refer to page 17 to view colors.*

### Lumex Preferred Care Drop Arm Recliner 565DG

All of the features and benefits of the Lumex Preferred Care Recliner plus – a unique drop arm mechanism. Self storing, height adjustable drop arm is simple for the caregiver to activate and enables a safer, easier lateral transfer for the resident and caregiver. Padded armrests provide a soft surface for added comfort. Directional wheel lock on right rear caster reduces “crabbing” of recliner and enables the chair to be moved down hallways with less effort.

#### Available Colors:

Blue Ridge 565DG427  
Doe Skin 565DG851  
Jade 565DG857  
Rosewood 565DG863

#### Fire Rated Colors

**Meets California Technical Bulletin 133  
Flammability Standards**

Blue Ridge FR565DG427  
Jade FR565DG857  
Rosewood FR565DG863

*Refer to page 17 to view colors.*





## PREFERRED CARE® RECLINER ACCESSORIES

### Activity Tray Table 5644G & 5644WG

- Strong polypropylene tray table offers a supportive, stable work surface for activities.
- Includes receiving arms, storage bracket, and strap.
- Easily stored in the back of chair.
- Patent pending “lock/ lock-out” key gives flexibility to the caregiver.
- 5644G fits 565G, 565DG and 565TG
- 5644WG fits 565WG



### Foot-Drop Assembly 5657G

- Helps keep resident's feet positioned correctly to help avoid foot-drop.
- Note: Foot-Drop Assembly will not fit 565WG.

#### Colors Available:

Blue Ridge	5657G427
Jade	5657G857
Rosewood	5657G863

*Refer to page 17 to view colors.*



**Head and Body Bolster 56461, 56462, and 56471**

- Soft, comfortable positioning devices.
- Available separately, they are easily installed without tools.
- Helps to maintain proper body alignment.
- Note: Body Bolster will not fit 565WG.

**Head Bolster (56461)**

**Colors Available:**

Vintage Gold	56461401
Warm Taupe	56461409
Imperial Blue	56461432
Royal Blue	56461454
Doe Skin	56461851

**Fire Rated Colors**

**Meets California Technical Bulletin 133  
Flammability Standards**

Vintage Gold	FR56461401
Warm Taupe	FR56461409
Blue Ridge	FR56461427
Imperial Blue	FR56461432
Royal Blue	FR56461454
Doe Skin	FR56461851
Jade	FR56461857
Rosewood	FR56461863

**Body Bolster (56471)**

**Colors Available:**

Vintage Gold	56471401
Warm Taupe	56471409
Royal Blue	56471454
Doe Skin	56471851
Rosewood	56471863

**Fire Rated Colors**

**Meets California Technical Bulletin 133  
Flammability Standards**

Vintage Gold	FR56471401
Warm Taupe	FR56471409
Blue Ridge	FR56471427
Imperial Blue	FR56471432
Royal Blue	FR56471454
Doe Skin	FR56471851
Jade	FR56471857
Rosewood	FR56471863

*Refer to page 17 to view colors.*

**Head Bolster for 565WG (56462)**

**Colors Available:**

Vintage Gold	56462401
Warm Taupe	56462409
Blue Ridge	56462427
Imperial Blue	56462432
Royal Blue	56462454
Jade	56462857

**Fire Rated Colors**

**(Meets California Technical Bulletin 133  
Flammability Standards)**

Vintage Gold	FR56462401
Warm Taupe	FR56462409
Blue Ridge	FR56462427
Imperial Blue	FR56462432
Royal Blue	FR56462454
Doe Skin	FR56462851
Jade	FR56462857
Rosewood	FR56462863



## Preferred Care® Recliner Accessories

**Adjustable Footrest LX5640G**

- Enhances patient positioning, comfort and aids in the prevention of foot-drop.
- Footrests tip up and out of way to allow access for easy patient transfer.
- Attaches without the use of tools.
- For use on Preferred Care Recliner.

**Universal IV Pole Holder 5782RG**

- Offers a tip-free means of administering internal feedings or IV therapy.
- For use on most Lumex Ortho-Biotic Seating with Lumex Bed Socket IV Pole (2101A) sold separately.

**Drainage Bag Hook with Privacy Pouch 5645**

- Helps improve resident dignity by disguising the drainage bag in a pouch that matches the upholstery.
- For use on 565 Preferred Care Recliners only.

**Available Colors:**

Blue Ridge	5645427
Jade	5645857
Rosewood	5645863

*Refer to page 17 to view colors.*



## HIP CHAIR GF4404

The Lumex Everyday Hip Chair is ideal for people who have arthritis or for patients who have undergone hip or knee surgery. The 27" high seat helps to reduce stress and fatigue on joints when entering and exiting the chair. Gently curving arms on the frame make sitting and standing easier. Padded armrests and a footrest provide greater comfort while sitting. The anti-slip strip on the footrest provides added safety. Sturdy metal frame.

Weight Bearing Capacity: 350 Pounds

Warranty:

Frame: Two Years

Upholstery: One Year

**Colors Available:**

Blue Ridge GF4404427

Jade GF4404857

Rosewood GF4404863

*Refer to page 17 to view colors.*



## LUMEX SPECIALTY HEALTHCARE SEATING: CUSTOMER SUPPORT AND SERVICE

All Lumex Specialty Healthcare Seating is protected by our **Wrap-around Limited Warranty**.

Lumex Specialty Healthcare Seating purchases are not just about price. They are about **COST IN USE**. Cost in Use is a concept that speaks to the Life Cycle of the product, not just the initial capital expense. Lumex Specialty Healthcare Seating is your solution because service parts and support are available to help you reduce the cost in use of your healthcare seating. All upholstery components can easily be replaced. This greatly extends the life of your Lumex Seating Product.

The Graham-Field Website, [www.grahamfield.com](http://www.grahamfield.com), is always available and is your resource for:

- ❑ Lumex Specialty Seating Schematic Drawings that clearly detail replacement parts and components. Schematics can be found on the website under the product Additional Information tab.
- ❑ Live Chat with a Graham-Field Technical Support Specialist
- ❑ A wide array of Specialty Seating accessories
- ❑ New Product Announcements

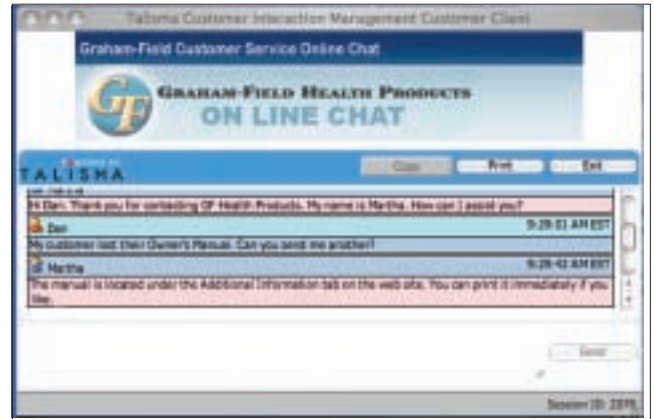
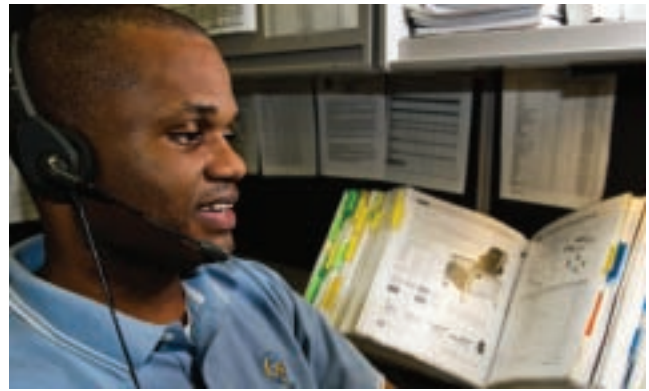

Customer Service and Technical Support:

**800.347.5678**

[www.grahamfield.com](http://www.grahamfield.com)

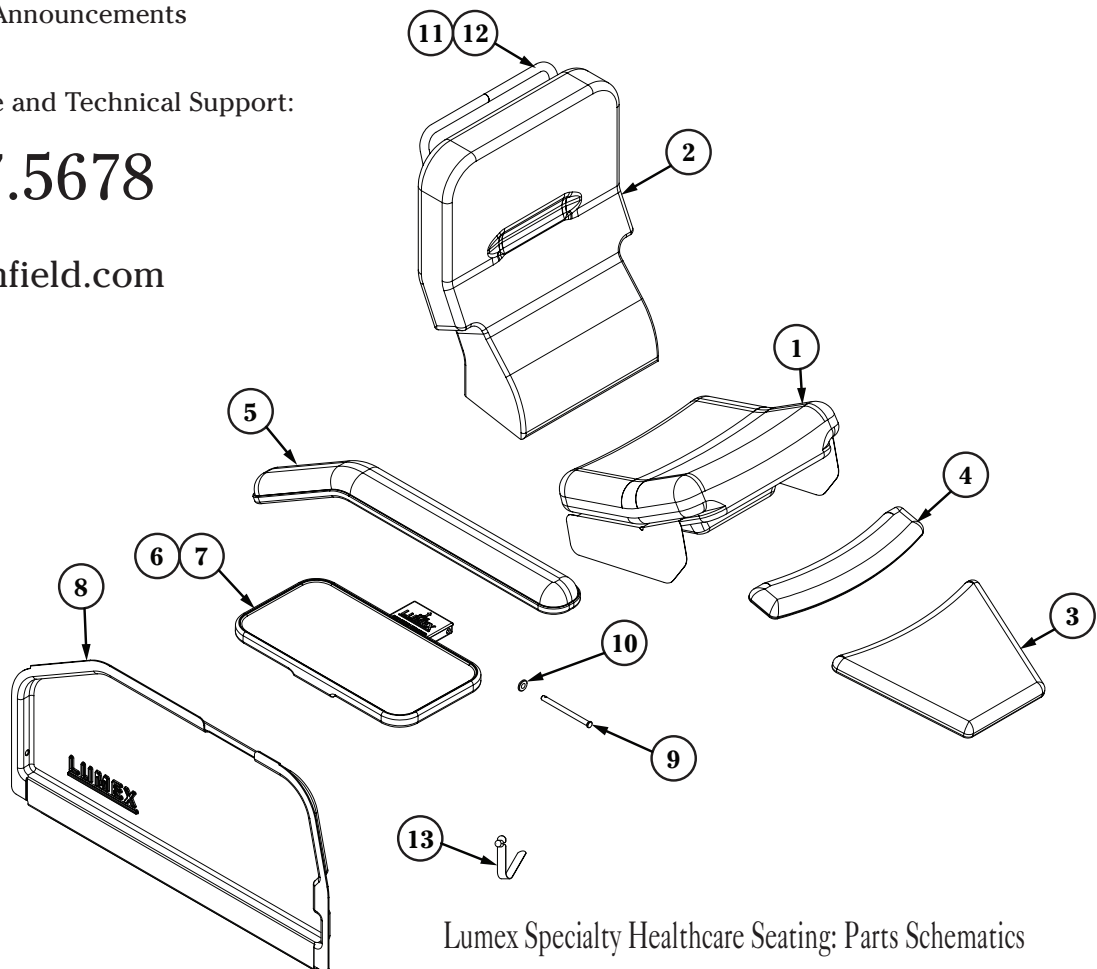

Lumex Specialty Healthcare Seating: Parts Schematics

# Specifications and Dimensions

Item	Overall Height	Overall Width	Overall Depth	Width Between Arms	Arm Height From Floor	Arm Height From Seat	Seat Height	Seat Width	Seat Depth	Depth Fully Reclined In Trendelenburg	Width With Both Side Tables in Upright Position	Shipping Weight	Max. Weight Capacity
FR566G	50"	31"	43"	21"	27 1/2"	8"	22"	20 1/2"	20"	75"	51"	145 lb	350 lb
FR566DG	51 1/2"	33"	38"	23"	28"	8"	22"	20 1/2"	19"	76"	53"	135 lb	350 lb
FR577RG	47"	31"	35"	22"	25 1/2"	8"	22"	21 1/2"	21"	74"	54"	127 lb	290 lb
FR587W	50"	33"	36"	23"	26 1/2"	8"	21 1/2"	23 1/2"	20 1/2"	76"	53"	138 1/2 lb	450 lb
FR588W	55"	38"	59"	25 1/4"	32"	8"	25 1/2"	25 3/4"	24"	71"	58"	308 lb	700 lb
FR3302	44"	31"	38"	23"	19 1/2" - 25 1/2"	5"	19"	21 1/2"	20"	-	-	109 lb	250 lb
574G	47"	25"	41"	20"	26"	9"	21"	19"	19"	-	-	110 lb	250 lb
565G	48"	28"	36"	19"	28"	8 1/2"	20"	19"	19 1/2"	-	-	80 lb	250 lb
565WG	48"	32"	37"	24"	28"	8 1/2"	20"	24"	19 1/2"	-	-	91 lb	400 lb
565TG	48"	28"	36"	19 1/2"	23 1/2" - 29 1/2"	0" - 8 1/2"	22"	19"	19 1/2"	-	-	90 lb	250 lb
565DG	48"	28"	36"	19 1/2"	23 1/2" - 29 1/2"	0" - 8 1/2"	22"	19"	19 1/2"	-	-	85 lb	250 lb
GF4404	42"	25 3/4"	26"	18"	31"	6"	26"	18"	18"	-	-	52 lb	350 lb

For the most up-to-date information and product specifications, please visit our website [www.grahamfield.com](http://www.grahamfield.com).



**GRAHAM-FIELD**<sup>®</sup>

GF Health Products, Inc. Atlanta, Georgia 30360  
800.347.5678 [www.grahamfield.com](http://www.grahamfield.com)

Graham-Field is not responsible for typographical errors. Packaging, warranties and product are subject to change without notice.  
© 2010 Lumex. A Graham-Field Brand. Is a registered trademark of GF Health Products, Inc. GF0900286 RevA10