

ZANUSSI

WASHING MACHINE T 613

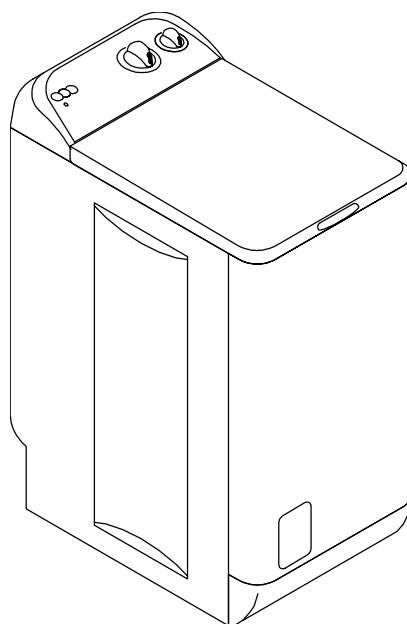

INSTRUCTIONS MANUAL

CONTENTS

For the user

Safety instructions	23/24
Description of the appliance	25
Use of your appliance	26
Operating instructions	27/28
Programme chart	29/30
Hints & Tips	31-33
Cleaning and maintenance	34
If something doesn't work	35/36
Service	37

For the installer

Technical information	38
Installation	
Unpacking	38
Installation	39
Levelling	39
Moving of the appliance	39
Water connection	40
Electrical connection	40

Guide to use the instruction

The following symbols will be found in the text to guide you throughout the instructions :



Safety instructions



Hints and tips



Environmental information



SAFETY INSTRUCTIONS

You must read the whole of this instruction book before you use the appliance. Follow the advice carefully. Keep the book for future reference. If you sell or give away the appliance, make sure that the book is passed to the new owner.

The following warnings are provided in the interest of overall safety. You must read them before the appliance is installed or used.

Use

- This appliance is designed to be used by adults. Children should not be allowed to touch the controls or play with the product.
- It is dangerous to modify the specifications of this appliance in any way.
- Always unplug the appliance and turn off the water after use.
- Only wash fabrics which are designed to be machine washed. If in doubt, follow the instructions you find on the label of the item itself.
- Place small metal rings or edged plastic rings in a net or bag.
- Make sure that all pockets are empty. Hard, sharp objects such as coins, safety pins, nails, screws or stones can cause extensive damage.
- Do not machine wash fabrics which are saturated with petroleum products. If volatile cleaning fluids have been used, make sure that they are thoroughly removed from the fabrics before they are placed in the appliance.

- Small and delicate objects (e.g. baby socks, stockings) can be easily washed inside a small pillowcase with a zip fastener or in larger socks.
- Use only the recommended quantities of fabric conditioner.
- Before cleaning, care and maintenance, ensure that the machine is unplugged.

Installation

- Any electrical work required to install this appliance should be carried out by a qualified electrician or competent person.
- Any plumbing work required to install this appliance should be carried out by a qualified plumber or competent person.
- Make sure that the appliance does not stand on its electrical supply cable.
- This appliance is heavy. Care should be taken when moving it.
- All packaging and transit bolts must be removed before the appliance is used. Serious damage may occur if this is not done.
- If your washing machine is in a room subject to temperatures below freezing, the water must be removed from the machine. So, the danger of freezing should be expected.

Read all instructions before using the appliance and save them for future reference.

Safeties

- Lid : your washing machine is equipped with a safety avoiding the switching of the appliance when the flapdoors of the drum are opened ; the closure of the lid is so impossible. An electromechanic safety prohibits the opening of the lid when the washing machine works and 2 minutes after the end of the programme.
- Washing motor : in case of mechanic overloading, overvoltage, a thermic safety protects automatically the motor.
- Heating : the heating can only begin when the water quantity necessary for the washing is in the tub. This safety is useful when there is a water break-up or if you forget to open the water inlet hose.
- Anti-balanced system : This safety allows to the appliance to keep a perfect stability during the intermediary spinnings and during the final spinning. If you notice that your laundry is not spinned enough, the anti-balanced system has then detected a bad distribution of the laundry during the final spinning ; so it is adviced to realize a new spinning taking care to unpack handly the laundry before.



Environmental information

All materials marked by the symbol  are biodegradable. They can be disposed of without danger or burnt in rubbish incinerators.

In order to realize water and energy savings and to act in an environmentally conscious manner, we advice to follow the below instructions :

- Use if possible the appliance with full loads instead of partial loads. Take care to do not overload the drum.
- Use only the programmes with prewash for very soiled laundry.
- Savings on detergent and for the environment may also be achieved if with medium to hard water you add sufficient detergent for soft water and then add separately a softener. This relieves our waters of a certain amount of chemicals.
- When disposing of the machine in a proper manner, destroy the door lock and cut off the power supply cord.

DESCRIPTION OF THE APPLIANCE

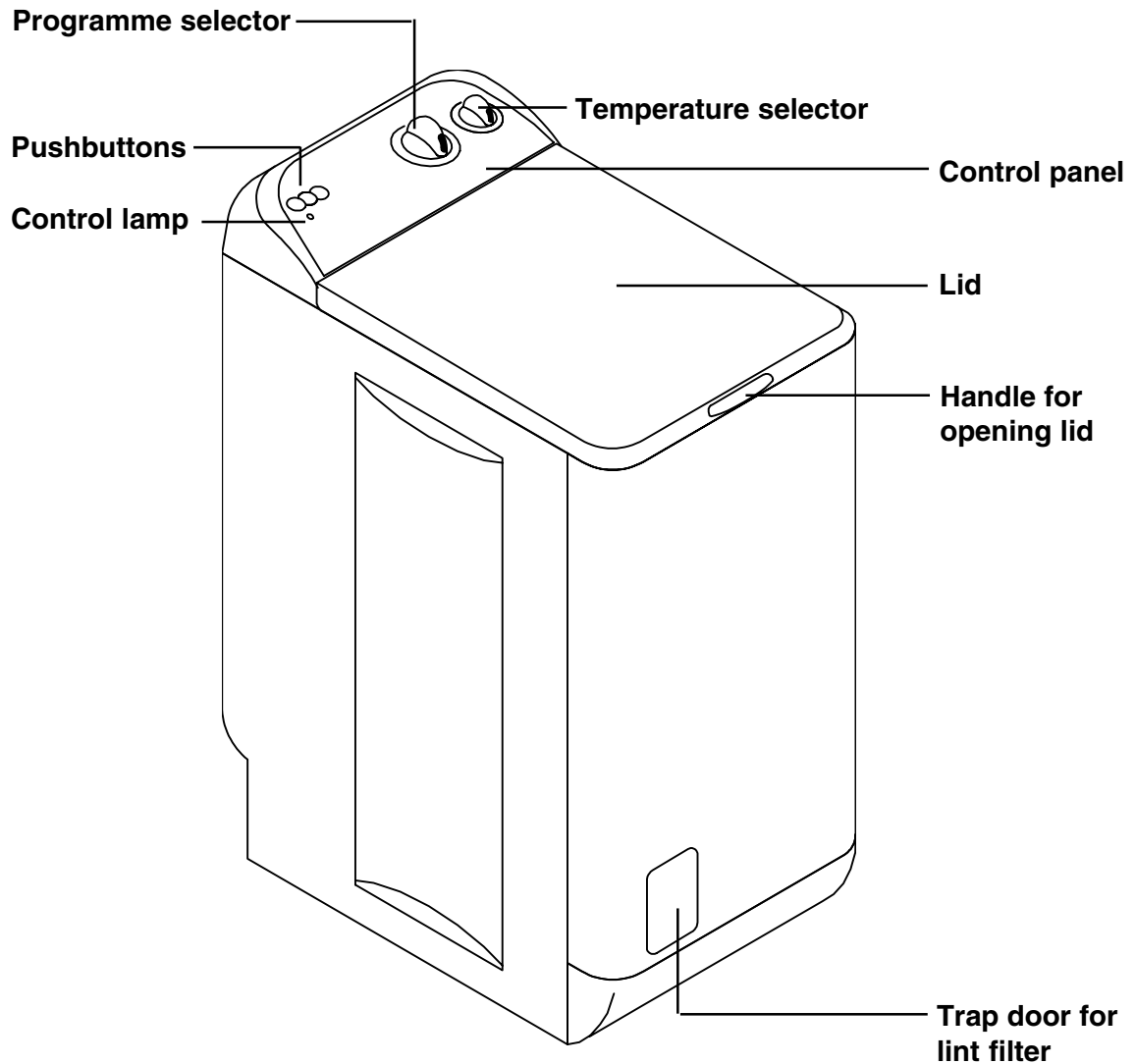

Detergent dispenser

Symbols

- (L) Washing powder for programmes with pre-wash (1).
- (L) Washing powder or liquid detergent for the main wash (2).
- (A) Bleach compartment (3).
- (S) Liquid additives (fabric softener and conditioner...) (4).
- 5 Softener overflow

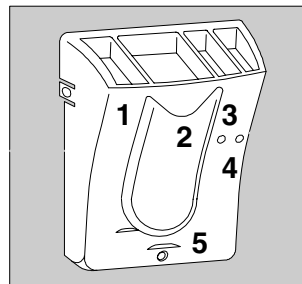

USE OF YOUR APPLIANCE

The control panel

Never turn the programme selector when the appliance is working.

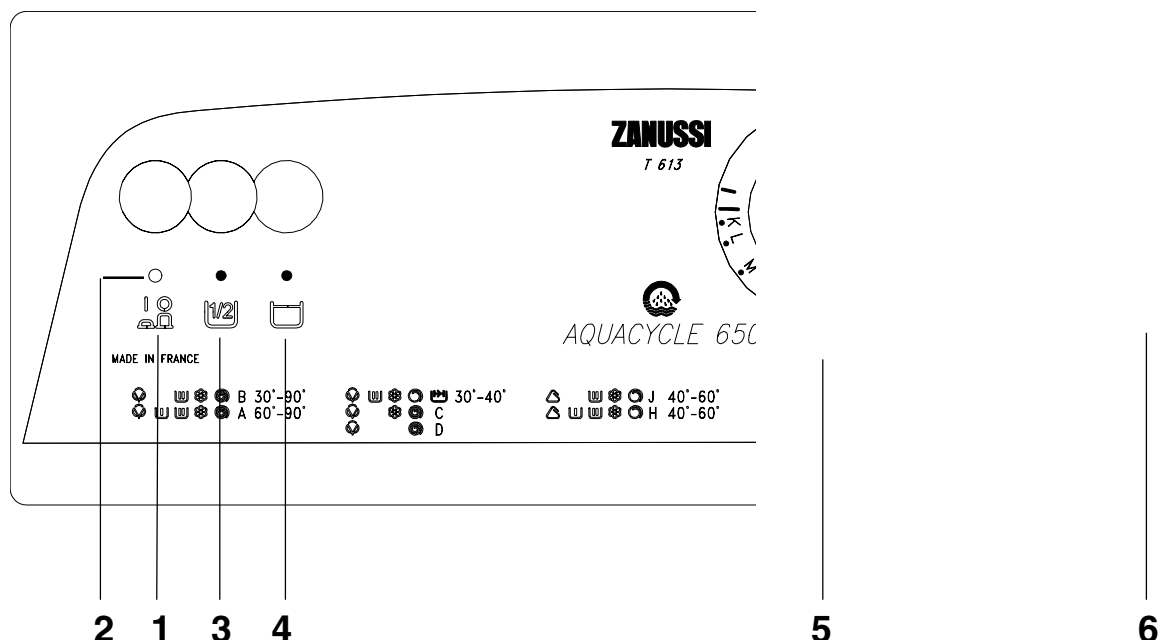

1 ON/OFF pushbutton "⏻"

Press the on/off pushbutton, the programme starts : the control lamp lights on.

2 Control lamp

The control lamp lights on when the appliance is working (on/off pushbutton "⏻" pressed). It lights off when the cycle is finished (programme selector on a stop position "I").

3 Half load pushbutton "1/2"

This pushbutton allows to wash small quantity of linen not much soiled (2,5 kg) only on the cotton programmes.

4 Rinse hold pushbutton "⏸"

Press this button to leave the water in the drum after the wash cycle is completed. This works on all the washing programmes. The clothes are left suspended in water after the final rinse to prevent the formation of creases.

5 Programme selector

It enables to select the most adapted programme to the nature and degrees of soil of your laundry. Turn the programme selector clockwise to select the chosen programme.

The programme selector indicates each programme phase as it takes place.

At the end of the programme, the appliance stops automatically on a stop position "I" for all the programmes or on a rinse hold position "I" if the rinse hold pushbutton is selected.

Never turn the programme selector anticlockwise.

6 Temperature selector

It enables to choose the most adapted temperature between cold (X) and 90°C.

Choose the temperature which corresponds to the chosen programme, with the help of the indications or the programme table, according to the fibers and the fastness of the colours.

OPERATING INSTRUCTIONS

Before using your washing machine for the first time, we recommend that you do a preliminary wash with the machine empty, as a precaution to clean the drum, tank and the product box.

1. Pour a dose of detergent in the "washing" detergent dispenser
2. Select the program B 90°C.
3. Press the on/off pushbutton "⏻".

1. Place the laundry in the drum

- lift up the lid of the machine.
- open the drum with your two hands by pressing the button **A** and the two flapdoors till they disengage.
- introduce the laundry into the drum ; close the drum and the lid of the machine.

Be careful : before closing the lid of your machine, make sure that the drum flapdoors are correctly closed :

- the two flapdoors fastened,
- the button **A** pressed out.

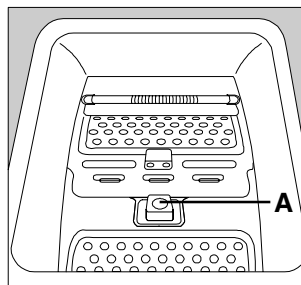

2. Measure out the detergent

Measure out the amount of detergent recommended by the manufacturer in the main wash compartment (L).

If you wish to carry out a prewash, pour the amount required into the prewash compartment (L).

3. Add the bleach agent, if required

You may use a bleach agent on cotton programmes. However, make sure that the fabric withstands the treatment. Bleach is automatically washed down into the drum. Pour 1/4 to 1 glass of 12° chl bleach into compartment marked (Δ) before switching the machine on.

4. Add the fabric softener

Pour the softener, if required, into the compartment marked (⊗). **Do not exceed the MAX level.**

Your washing machine has been conceived in order to save water and detergent products. Please take care the filling level of the detergent products do not exceed the MAX marks located near the display window of your detergent dispenser.

5. Press the half load pushbutton "1/2" and/or the rinse hold pushbutton "□" if required.

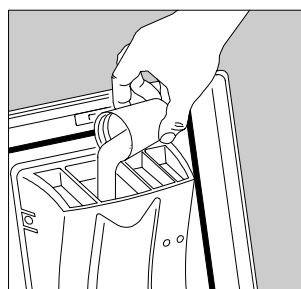

Liquid detergent
only compartment (L)

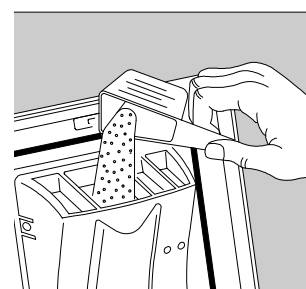

Powder detergent
Compartment (L)
(prewash)
Compartment (L)
(wash)

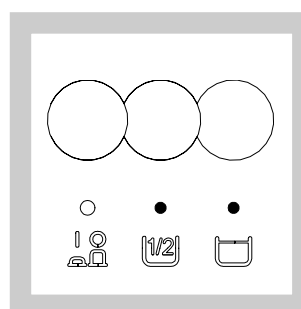

6. Select the temperature

Choose the temperature which corresponds to the chosen programme, with the help of the indications or the programme table, according to the fibers and the fastness of the colours.

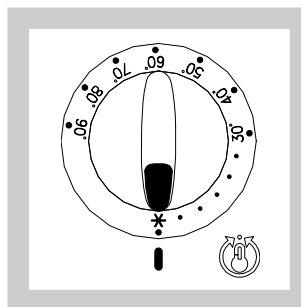

7. Select the programme

Choose the programme according to the nature and the degree of soil of the laundry. Turn the programme selector clockwise to select the chosen programme.

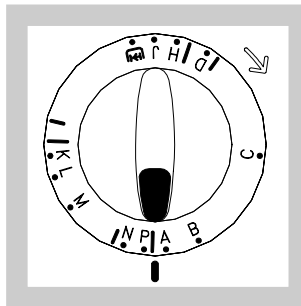

8. Starting of the programme

The on/off pushbutton "I/O" enables to switch on your machine. The control lamp lights on and the programme begins.

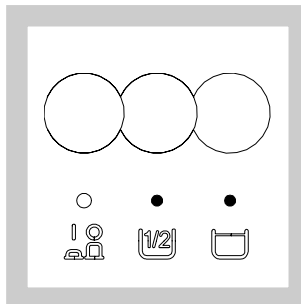

9. At the end of the programme

When the selected programme is over, the machine stops automatically. The timer knob stops on the position "I" for all the programmes and the control lamp lights off.

If the rinse hold pushbutton "□" is selected, the washing programmes (cotton or synthetics) end by a rinse hold in order to avoid the formation of creases. The control lamp keeps lighted on. You can finish these programmes by a spinning (by releasing the rinse hold pushbutton) or by a draining (by depressing the on/off pushbutton "I/O" and by choosing the programme P).



After each wash, depress the on/off pushbutton "I/O". Press off the other pushbuttons if necessary; unplug the machine from the wall socket ; turn off the water tap.

After each wash cycle, we recommend that the lid and drum are left open after use to air the drum and prevent mould and stagnant smells forming.

PROGRAMMES CHART



Programmes for cotton/linen

Maximum load : 5,0 kg (cotton)

Programmes	Programme descriptions	Temperatures °C	Descriptions of the cycle	Consumptions *		
				Water (l)	Energy (kWh)	Time (min)
A	White + 	60° - 90°	Prewash to 40° Wash to 60°-90° 3 rinsings Spinning	75	2,3	150
B	White	30° - 90°	Wash to 30°-90° 3 rinsings Spinning	65	2,0	130
	Quick programme (max load : 2,5 kg)	30° - 40°	Wash to 30°-40° 3 rinsings Short spinning	47	0,55	65
C	Rinsings		4 rinsings Spinning	60	0,2	50
D	Spinning		Spinning 650 rpm	0	0,04	10

(*) These consumptions given (with the highest temperature) in the above table are provided as a guide and may vary depending on the water supply temperature and pressure, and your electricity power supply mains voltage.

When the selected programme is over, the washing machine stops automatically. The timer knob stops on the position "I". The control lamps lights off.





If the rinse hold pushbutton  is selected, the washing programmes end by a rinse hold in order to prevent the formation of creases. The control lamp keeps lighted. You can finish these programmes by a spinning (by releasing the rinse hold pushbutton) or by a draining (by depressing the on/off pushbutton  and by choosing the programme P).

BE CAREFUL :

THE LID CAN ONLY BE OPENED 90 SECONDS AFTER THE MACHINE HAS STOPPED.



Programmes for synthetics/delicates/wool

Maximum loads : 2,5 kg (synthetics), 1 kg (wool).

Programmes	Programme descriptions	Temperatures °C	Descriptions of the cycle	Consumptions*		
				Water (l)	Energy (kWh)	Time (min)
H	Synthetics + 	40° - 60°	Prewash to 40° Wash to 40°-60° 3 rinsings Short spinning	60	1,2	95
J	Synthetics	40° - 60°	Wash to 40°-60° 3 rinsings Short spinning	47	1,0	80
	Quick programme	30° - 40°	Wash to 30°-60° 3 rinsings Short spinning	47	0,55	65
K	Delicate	30° - 40°	Wash to 30°-40° 3 rinsings Short spinning	47	0,55	55
L	Wool	 - 40°	Wash to  -40° 3 rinsings Short spinning	45	0,5	50
M	Rinsings		3 rinsings Short spinning	33	0,04	25
N	Short spinning		Short spinning	0	0,02	8
P	Drain		Drain	0	0	4

(*) These consumptions given (with the highest temperature) in the above table are provided as a guide and may vary depending on the water supply temperature and pressure, and your electricity power supply mains voltage.

When the selected programme is over, the washing machine stops automatically. The timer knob stops on the position "I". The control lamp lights off.

If the rinse hold pushbutton  is selected, the washing programmes end by a rinse hold in order to prevent the formation of creases. The control lamp keeps lighted. You can finish these programmes by a spinning (by releasing the rinse hold pushbutton) or by a draining (by depressing the on/off pushbutton  and by choosing the programme P).

BE CAREFUL :

THE LID CAN ONLY BE OPENED 90 SECONDS AFTER THE MACHINE HAS STOPPED.



HINTS AND TIPS

Washing hints

You are advised not to leave your laundry too long, especially when damp. Damp laundry produces mould and unpleasant smells.

Mould stains cannot be removed.

Sort your laundry.

Study carefully the chart in this booklet explaining the symbols used on clothes labels (see page 14).

The following points are particularly important :

- a line under the bowl means that the garment cannot be washed using programmes for resistant fabrics such as cotton and linen;
- do not mix coloured garments with whites;
- antcrease materials like polyester/cotton should be treated as synthetics;
- non-resistant fabrics like acrylic and most curtain materials should be treated as delicate fabrics;
- the wool programme is designed specifically for pure new wool. Other types of wool and wool mixtures may shrink or felt if machine-washed. Woollen garments should be spun briefly immediately after washing.

Prewash

Prewash is not normally necessary. Your new washing machine combined with modern detergents will give perfect washing results without prewash, thus saving energy, time, water and detergent.

However, when the laundry is particularly dirty (for example if you have to wash mechanics' overalls or butchers' aprons), you are advised to use prewash with a biological detergent.

Temperatures

We suggest that white cotton and linen, if it is not excessively soiled, can be washed at 60° instead of 90°C. There should be no reduction in performance, but there will be an energy saving of approximately 30%.

The same applies to a lesser extent to fast coloured garments.

They usually require a temperature of 60°C but if they are not excessively dirty, you will have satisfactory results at 40°C.

Garments with non-fast colours should not be washed at temperatures above 40°C. If fast and non-fast colours are washed together, they should be treated as non-fast colours and therefore the temperature should not exceed 40°C.

Resistant white and coloured synthetics can normally be washed at 60°C but also in this case 40°C is sufficient if the laundry is not excessively dirty.

Delicate synthetics, synthetics with non-fast colours and woollen garments must never be washed above 40°C.

As you already know, your washing machine can also wash with cold water. However, it must be remembered that the detergents currently on the market have not been designed for cold washes and that in winter, when the water is very cold, they may not dissolve adequately.

We suggest the use of liquid detergents.

How much laundry can be washed in one load?

Strictly speaking you should always weigh your laundry.

The drum will take a maximum of 5 kg of cotton and linen. For synthetics and delicate fabrics, the maximum load is 2,5 kg and for wool, 1 kg.

As weighing can be complicated, we suggest you estimate the weight according to how full the drum is:

cotton and linen : drum full not too tightly packed
resistant synthetics : no more than 2/3 of the drum

delicate fabrics and wool : no more than 1/2 of the drum.

Before placing the laundry in the machine:

- mend all tears, holes and ladders;
- secure loose buttons and close poppers and zips;
- do not wash frayed garments - mend hems before washing;
- remove all small objects from pockets. Nails, pins, clips and similar objects can seriously damage your washing machine and laundry;
- remove curtain hooks;
- wash coloured garments and in particular those with non-fast colours separately when washing for the first time. They are likely to lose colour the first time they are washed.
- treat obstinate stains such as grass, rust, tar, paint, ink etc. with a stain remover before washing.

To remove paint stains, for example, use a volatile substance such as turpentine: in this case, you should wait for it to dry completely before washing. The manufacturer of your washing machine is not responsible for any damage deriving from the use of volatile, inflammable or toxic substances.

At the end of the washing

Damp laundry should be dried as soon as possible after finishing the wash.

Knitwear and woollens should be dried flat away from direct sunlight.

Detergents and additives

Good washing results also depend on the choice of detergent and use of the correct quantities to avoid waste and protect the environment. Although biodegradable, detergents contain substances which in large quantities can damage the delicate ecological balance of nature.

Always use good quality detergents suitable for use in washing machines.

Follow the indications given by the detergent manufacturer according to the weight of laundry, the degree of soil and the hardness of the water in your area; if you do not know how hard it is, ask your local Water Authority.

Powder detergents.

The washing powder should be placed in the appropriate compartments of the dispenser drawer before starting the programme. Special detergents are available for coloured and delicate fabrics and for wool.

"Concentrated" powder detergents

Pour the concentrated powder detergent into the main wash (I) compartment.

Avoid selecting programmes including prewash when concentrated detergents are used.

Water hardness

Level	Characteristic	German degrees		French degrees °T.H.
		°dH	m mol	
1	Soft	0 - 7	0 - 1,3	0 - 15
2	medium	8 - 14	1,4 - 2,5	16 - 25
3	hard	15 - 21	2,6 - 3,8	26 - 37
4	very hard	> 21	> 3,8	> 37

Liquid detergents

Using the new automatic dispenser for liquid detergents, it is possible to use a liquid detergent for main wash phases if you start the washing machine immediately.

Liquid detergents can be used instead of powder detergents particularly for lightly soiled laundry and for medium or low temperature washing programmes, while it is better to use a powder detergent for high temperature washing programmes.

Liquid additives

Any liquid additives for softening the laundry must be poured into the compartment (II) of the detergent dispenser drawer before starting the programme. The addition of water softener is particularly useful when drying the clothes in a tumble dryer after washing to avoid a static charge.

Make sure that the level of the liquid never exceeds the MAX level.













Bleach



You may use a bleach agent on cotton programmes. However, make sure that the fabric withstands the treatment. Bleach is automatically washed down into the drum. Pour 1/4 to 1 glass of 12° chl bleach into compartment "III" before switching the machine on.





Make sure that the level of the liquid never exceeds the MAX level.



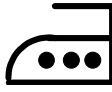

Wasch code symbols

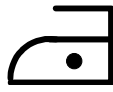



These symbols appear on fabric label, in order to help you choose the best way to treat your laundry.

STRONG WASH   DELICATE WASH	 Max. wash Temperature 95°C	 Temperature 60°C	 Temperature 40°C	 Temperature 30°C	 Hand wash	 Do not wash at all
	  					

 BLEACHING	 Bleach in cold water	 Do not bleach
---	---	--

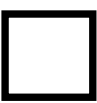
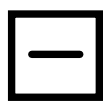
 IRONING	 Hot iron max 200°C	 Warm iron max. 150°C	 Lukewarm iron max. 110°C	 Do not iron
---	---	---	---	--

 DRY CLEANING	 Dry cleaning in all solvents	 Dry cleaning in perchlorethylene petrol, pure alcohol, R111 & R113	 Dry cleaning in petrol, pure alcohol, and R113	 Do not dry clean
--	---	---	---	---

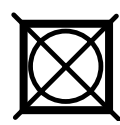
 DRYING	 Flat	 On the line	 On clothes hanger	 High temperature  Low temperature Tumble dry	 Do not tumble dry
--	---	--	--	---	--

CLEANING AND MAINTENANCE



Make sure that the machine is unplugged and the water tap turned off before undertaking any kind of maintenance.

Bodywork

The outside of the machine can be cleaned with warm water and a neutral non-abrasive household detergent. Wipe with clean water and dry after cleaning.

Important : do not use methylated spirit, diluents or similar products.

It is advisable, from time to time, to carry out a complete cycle without a washing load, adding a decalcifying product.

The detergent dispenser

The detergent dispenser is very easy to remove.

Exert a pressure on the brooches located on each side of the detergent dispenser and pull it up (fig.1 and fig.2).

Clean the detergent dispenser under running water with a brush or a piece of rag (fig.3). Check that the siphons located at the back of the detergent dispenser are not obstructed (fig.4).

Replace the detergent dispenser in the notches until the hanging (fig.5).

The drain filter

The machine has got a mechanic filter located on the front part to collect lint and small objects (toothpins, coins, pins, etc) inadvertently left in the clothes. It is essential that this filter is cleaned regularly.

Frequency of cleaning depends on the type of articles washed (cleaning should be more frequent if the articles have no hem and tend to fray).

- Open the flapdoor (fig.6)
- To drain the residual water :
Place below a container not very high up with straight edges. To complete the draining, turn the cap of the drain filter until its vertical position and the residual water will be released (fig.7).
- To clean the filter :
Turn the filter anticlockwise and get it away (fig.8).
Clean it with current water. Replace the filter and screw down it clockwise. Then, close the flapdoor.

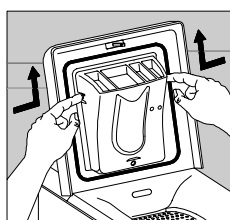

fig.1

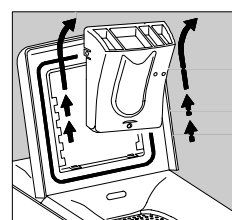

fig.2

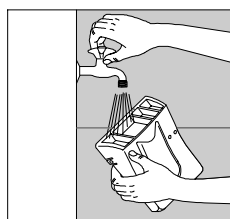

fig.3

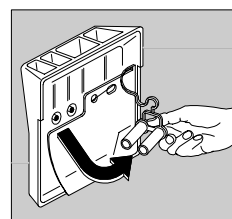

fig.4

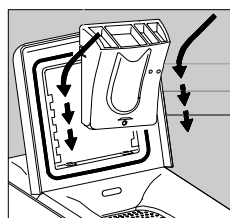

fig.5

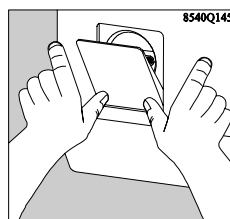

fig.6



fig.7

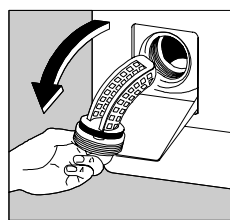

fig.8

IF SOMETHING DOESN'T WORK ?

Problems	Solutions
The wash results are not as usual	<p>Check that :</p> <ul style="list-style-type: none"> ■ was the wrong quantity or the wrong detergent added ? Insufficient detergent leads to grey washes and scale deposits in the machine. Check the quantities more exactly. ■ were special stains pre-treated ? ■ were programme and temperature correctly chosen ?
The washing cycle is very much too long.	<p>Check that :</p> <ul style="list-style-type: none"> ■ the water pressure is sufficient. ■ the pump filter is not obstructed. ■ there has not been a power breakdown.
The washing machine stops during a washing cycle.	<p>Check that :</p> <ul style="list-style-type: none"> ■ the water pressure is sufficient. ■ the pump filter is not obstructed. ■ the mains fuse is intact. ■ there is not a rinse hold ending a washing programme (see the programmes chart pages 29 and 30).
The machine does not start up	<p>Check that :</p> <ul style="list-style-type: none"> ■ the mains fuse is intact. ■ the appliance is plugged in,. ■ the lid is firmly shut. ■ the programme selector dial is correctly positioned. ■ the beginning of the programme has been ordered (on/off pushbutton pushed on). ■ there has not been a power breakdown.
The machine does not drain and/or does not spin	<p>Check that :</p> <ul style="list-style-type: none"> ■ the drain hose is not squashed or bent. ■ the drain filter is not clogged.
The machine does not fill	<p>Check that :</p> <ul style="list-style-type: none"> ■ the inlet water hose is opened and the water pressure is sufficient. ■ the lid of the appliance is closed. ■ there has not been a power breakdown.

IF SOMETHING DOESN'T WORK ?

Problems	Solutions
The machine vibrates or is too noisy	<p>Check that :</p> <ul style="list-style-type: none"> ■ all the transit bolts and packing have been removed. ■ all the feet resting firmly on the ground, the lock nuts have been secured. ■ the machine does not touch something. ■ the load is sufficient.
The machine empties as it fills	<p>Check that :</p> <ul style="list-style-type: none"> ■ the end of the drain hose is not too low.
There is water on the floor	<p>Check that :</p> <ul style="list-style-type: none"> ■ there is not too much detergent or unsuitable detergent. The formation of foam can cause water leaks. ■ one of the detergent dispenser is not obstructed. ■ the drain hose is well hanged. ■ if one of the joints or the tap leaking ? it is not always easy to see as the leak often runs along the hose. ■ is the drain filter cover properly closed ?
Softener detergent flows out the overflow orifice	<p>Check that :</p> <ul style="list-style-type: none"> ■ you have respected the advised quantities. ■ check that the siphons located at the back of the detergent dispenser are not obstructed.

SERVICE

If you have unable to identify or solve the problem, consult our servicing department. Before telephoning, make a note of the make, model and date of purchase of your machine : the service department will require this information.

Data plate

You will find these informations on the data plate (at the back of the appliance) and on a sticker placed on the internal door filter.

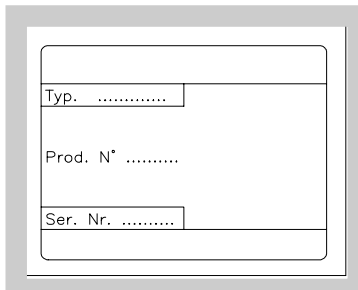

Typ.
Prod. N°
Ser. Nr.

Protection against pests

You can request to your Service Department the protection against pests in order to put it under the appliance.

FOR THE INSTALLER

Technical information

Dimensions	height with panel	895 mm
	height without panel	850 mm
	width	397 mm
	depth	600 mm
Power supply voltage / frequency		230 V / 50 Hz
Total power absorbed		2300 W (10 A)
Heater rating		1950 W
Water pressure	minimum	0,05 MPa (0,5 bar)
	maximum	0,8 MPa (8 bar)
Maximum load	cotton	5,0 kg
	synthetics	2,5 kg
	wool	1,0 kg
Spinning speed		650 rpm
Electrical consumption (washing at 60°C)		1,25 kWh

CE This appliance complies with the following EC Directive :
 - 72/23/EEC of 19.02.1973 - Low-Voltage Directive
 - 89/336/EEC of 03.05.1989 (including Amentment Directive 92/31/EEC) - EMV Directive.

Installation

Unpacking

The parts protecting the inner components of the machine during transit must all be removed before using your machine for the first time. These parts and their securing means should be kept in case the machine has to be transported again.

- Unpack the appliance. Tilt the appliance backwards. Give to one of the back corners a quarter turn. The appliance comes free naturally out the polystyrene basis. Take away this basis (fig. 1).
- Open the lid of the appliance and remove the polystyrene and plastic wedges which block the drum. Close the lid (fig. 2).
- On the back part and with a spanner, remove the two loosened spacers (A) (fig. 3).
- The holes which are now visible must be closed with the plugs (B) provided with the appliance (fig. 4).
- Please ensure that these parts have been removed from the machine and keep them in case of next transport (fig. 5).
- If you want to keep the alignment of your appliance with the adjacent cupboards, you have the possibility to cut the crossbar holding the hoses located at the back of your washing machine (fig. 6).

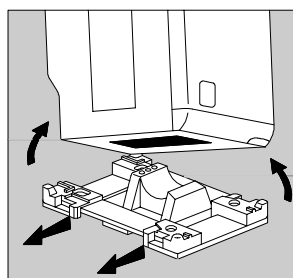

Fig. 1

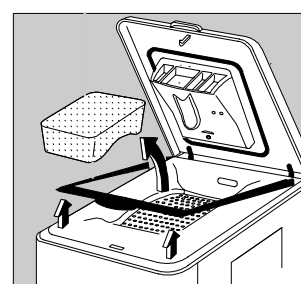

Fig. 2

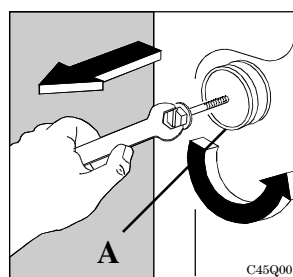

Fig. 3

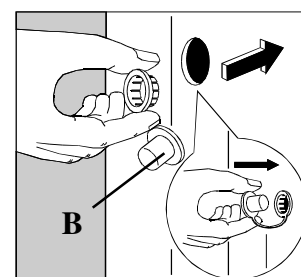

Fig. 4

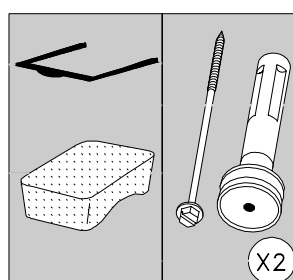

Fig. 5

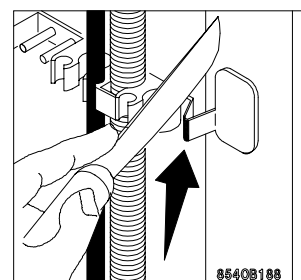

Fig. 6

Installation

The floor must be clean and dry, free from floor polish and other greasy substances, so that the machine does not slide about. Do not use any grease as lubrication.

Installation on deep pile carpets and floor coverings with foam backings is not recommended, as the stability of the machine is no longer guaranteed. If the installation must be done on a carpeted floor, the openings located at the lower part of the back of the appliance **must remain free**. These openings ensure a good ventilation of your appliance. In case of small format tiles, place a standard rubber mat under the machine.

With sprung floors, in particular wooden plank floors with yielding floor boards, screw down a waterproof wooden base at least 15 mm thick, across at least 2 floor boards. Wherever possible, place the appliance in the corner of the room - there wooden floors are most secure and least liable to resonance vibrations.

Never compensate for small unevennesses in the floor by placing wood, pasteboard or such like.

The front adjustable feet must be blocked after installation of the appliance by means of the locking nuts.

Levelling

It is essential that your machine is absolutely level. Raise or lower the front feet of the machine; tighten the nuts of the feet with an adjustable wrench (fig.1).

Also make sure that the machine does not touch the wall, the furnitures etc. during the functioning. This in order to avoid vibrations, noise or displacements of the appliance during operation.

To move the washing machine, use the wheels at the back of the appliance by pulling up the appliance.

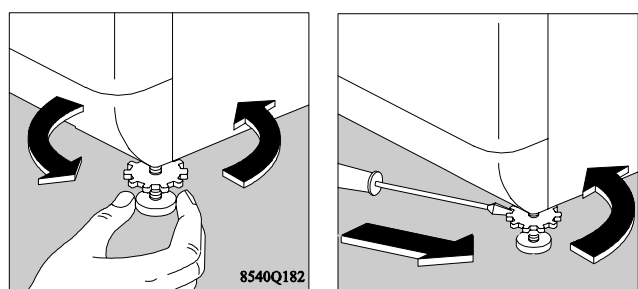

Fig. 1

Water connection

Connect the water inlet hose to a cold water tap with a 3/4" gas threaded orifice, after having inserted the rubber sealing washer into the hose collar (fig.1). If the water connection is made onto new pipes or onto pipes which have not been used for a long time, it is advisable to run off a certain amount of water before connecting the machine. Place the curved end of the outled hose into a drain pipe having a height between 70 and 100 cm from floor level (fig.2) or secure it to a sink (fig.3). Make sure that the drain hose is firmly secured so that it will not slip out or fall down from its position.

The water should drain freely and, consequently, the drain hose should not be choked or placed in such a way as to obstruct the normal water flow. If an extension hose is required, remember that it might cause a malfunction in the drain pump, particularly if the extension has a length in excess of 1 meter or if the diameter of the extension is smaller than the diameter of the original drain hose.

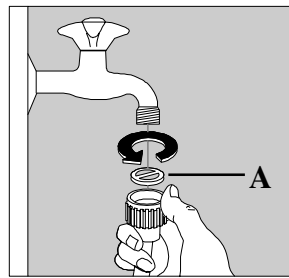

Fig.1

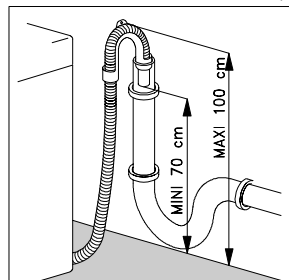

Fig.2

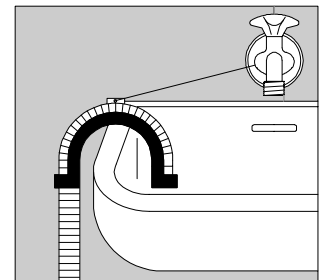

Fig.3

Electrical connection

Before you fit the plug into the wall socket, check the following points :

- 1) The supply voltage of the domestic wiring system does not fluctuate by more than 10%, plus or minus, from 230 V.
- 2) The meter, the fuses, the supply line and the wall socket are suitable to carry the maximum load required by the machine (2,3 kW).

Very important :

The washing machine is provided with a feeding wire with earth connection: it must be connected to a plug like that is provided with a good earth connection. The wall plug must be easily accessible.

The replacing of the power cord must only be realized by the After Sales Service in order to avoid any danger.

The manufacturer declines any responsibility where the previous recommendations are not followed.

