

Haier

Inspired Living

Haier

Inspired Living

Follow these simple tips and maximize the efficiency of your washing machine and your efforts to save the money.



- Clean out the dryer's lint trap after every load to improve circulation & reduce energy use.



- Service the machine at regular intervals, as directed in the User Manual.

Haier
CUSTOMER CARE

1860-180-3333

MTNL/ BSNL

6 0 0 0 9 0 9 0

(accessible from other services,
including Mobile by adding local STD code)

w.e.f. 01.03.2008

Haier
Inspired Living

HAIER APPLIANCES (INDIA) PVT. LTD.
B-1/A-14, Mohan Co-operative Industrial Estate, New Delhi-44
Ph.: 26952470/71/72/73. Fax: 011-26971562

OWNER'S MANUAL

Semi-Automatic Washing Machine
XPB62-0613D

USER GUIDE FOR WASHING MACHINES FROM



Please read this instruction manual carefully before operating your machine. Retain it for future reference.
Record model name & serial number of the machine. Please quote this information when you require service.

Contents

	Page No.
Description of Parts	3
Description of Control Panel	3
Safety Precautions	4
How to install	5
How to wash	5
Spin Shower	6
How to Spin	7
Care and Maintenance	8
Trouble Shooting	8

Index

Introduction	9
Product Features	9
Installation	11
Operation	11
Washing Programs	11
Spin and Drain	13
Water Level	14
Energy Saving	15
Child Lock	16
Specification	
Warranty Terms and Condition	
Warranty Card	
Branch Offices	

The primary concerns that drive our efforts to design and develop quality products are your Health and Pleasure. This is one such washing machine that has been designed specially with advanced features for your convenience, to provide brightest and hygienic wash in an effortless way. So go ahead and enjoy the pleasure of **HAIER** Washing Machine at your service.

● RUST FREE

This machine is made of **Hi Impact Polymer Fiber** which is rust free. This gives your machine a longer life.

● BUBBLE WASH

The Haier washing machine has unique Pulsator design that provides a special wash. This unique system gives a vertical as well as a horizontal flow water creating more turbulence. This ensures that the tougher stains are removed to a greater extent.

● UNIQUE SPIN FOUNTAIN

When the washed clothes are transferred into the spin tub, there are chances of the detergent still remaining in the clothes. This washing machine has a special inlet in the spin tub through which water is showered onto your clothes. This ensures that any traces of detergent left on the clothes removed before drying.

● 2 WASH PROGRAMMES

● HEAVY WASH

For your Daily wear synthetic and Linen garments. For Jeans, Bed Sheets, Curtains etc.

● NORMAL WASH

For your Delicate Garments.

Description of Parts

1. Control Panel of Machine
2. Inlet Hose Connector
3. Wash Tub Lid
4. Wash Tub
5. Overflow Filter
6. Quadra Pulsator
7. Spinner Lid
8. Inner Lid
9. Spinner Tub
10. Power cord
11. Drain Hose
12. Spinning Cap
13. Inlet Hose

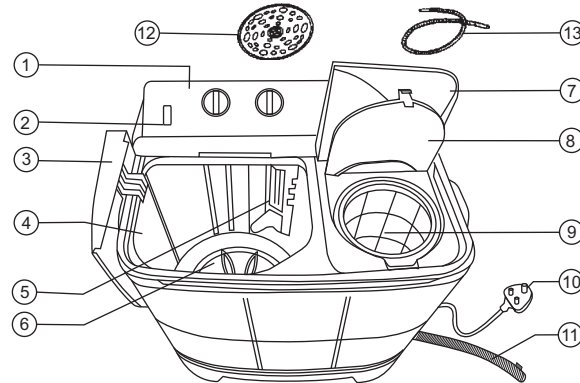

Note : Please do not match this figure with your machine as it may be different from your model. These are schematic diagram only.

Description of Control Panel

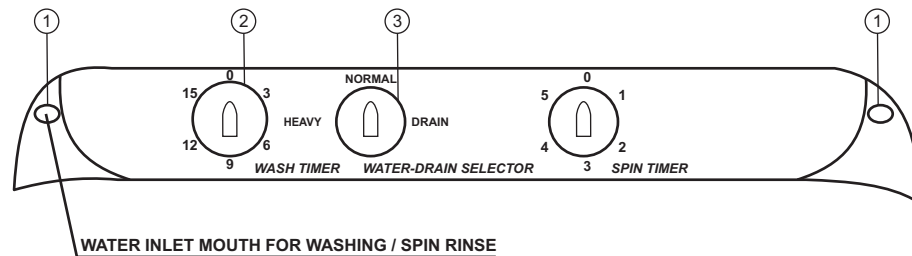

1. Water Inlet : This is used to direct water supply to wash tub for washing or spin tub for spin shower.
2. Wash Timer : This timer is used for WASH operations.
 - A) Wash :- You can select any Wash time up to 15min. by setting the time knob between 0~15 min.
 - B) Wash/Rinse :- You can select any Wash/Rinse time upto 15 min. If you want Wash/Rinse time for shorter duration turn the knob upto 10 min. position and then turn it back to desired position.
3. Wash-Drain Selector : Set the knob to 'NORMAL', 'HEAVY' according to kinds and quantity of the laundry.
 - 'HEAVY', 'NORMAL' for wash program.
 - Select DRAIN for draining the water from the wash tub.
4. Spin Timer : This timer is used to select your desired length of time to spin laundry by using 5 minutes timer. (if you want to set the timer to 2 min. or less, turn the selector up to the 5 min. position, and then turn it back to the desired position.

Note : Wash Cycle do not operate when knob is at "DRAIN" position.

Note : Do not rotate the knobs more then prescribed limits. This may damage the timers.

Safety Precautions

Do not use Washing Machine to wash items other than Clothes, Blankets, Curtains, Towels, etc.
Never disassemble, Repair or Remodel this washing machine. This can cause fire or irregular action that may Result in injury

Consult your nearest service centre for repair

Install the washing machine on sturdy floor of which maximum permissible inclination is 2 degree.

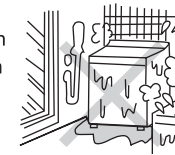

If machine is installed on Carpet, be sure that Carpet does not block any openings.

Do not place flammable substances near the machine such as Kerosene, Benzine, Paint Thinner and Alcohol. Do not put clothing with such substances in the tub.

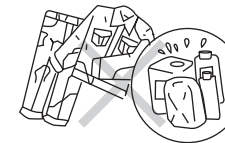

There is a risk of Explosion or Fire

When spinning always use the spinning cap pressing tightly against the clothes, maintain the horizontal level

Do not use water hotter than 50° C for wash water.

It is recommended to drain all the water from wash tub if any, after completion of your wash cycle.

Never touch laundry with your hand during the spin cycle until the tub has completely stopped spinning. If you touch the laundry, even if the tub is rotating slowly, there is a danger of injury if your hand becomes entangled with the laundry. Pay particular attention to protecting children from such injury



When the washing machine gets dirty, wipe it with the slightly wet cloth.

Do not use machine when power cord is torn or damage, Removing the power plug from the power outlet, you should remove it by pulling its insulated body not its cord. And do not place the machine or any heavy objects on the power cord; it may cause the damage to the power cord. If the power plug or power cord is damaged, contact your nearest service center.



Please do not put your hands under the machine, as there is a rotating mechanism.

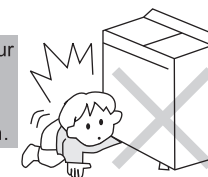

NOTE :

"This appliance is not intended for use by persons (including children) with reduced physical, sensory or mental capabilities, or lack of experience and knowledge, unless they have been given supervision or instruction concerning use of the appliance by a person responsible for their safety. Children should be supervised to ensure that they do not play with the appliance."

How to Install

- 1) Install the Washing machine in a well-ventilated, safe place. Machine should be put on flat ground and where can you connect the power supply. It is recommended to place the washing machine on a leveled floor and avoid a place where the washing machine can be exposed to direct sunlight.
- 2) Insert the power plug firmly into the main power supply.
- 3) Water supply in the inlet hose can be adjusted to Wash Tub or Spin Tub.
- 4) The feeding water indicator -
When the water spills out of the hole above the label, it means too much water has been supplied. Adjust the water tap.
- 5) Pull out the drain hose from the washing machine. When using the machine for the first time, you may find water remaining in the drain hose. It was used for the factory performance test. It does not imply any malfunction.

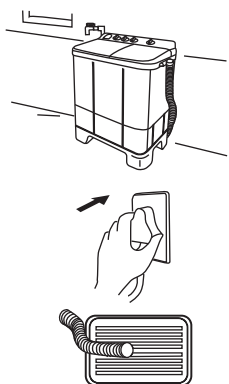

Preparation for Washing

1. The machine should be put on Flat Ground.
2. Ensure Three Core Power Plug seat must have Ground Connection.
3. Lay down the Drain Hose.
4. Connect the water Inlet Hose to Water Tap.
5. Remove objects like coins, pins etc., from clothes before washing. They may damage your clothes and clog the drain system.
6. According to the weight of cloth, adjust the level of water.
7. Switch ON power.

How to Wash

1. Set the wash selector knob to "Heavy or Normal".
2. Fill the tub with water according to the weight of cloth (Refer table 1 and 2).
3. Put the clothes in the tub. Do not put an excessive amount of laundry, in the tub. (Refer table 1 and 2).
4. Put recommendable quantity of detergent as mentioned in Table 1.
5. Set Wash Time upto 15min, depending on your cloth load & type (Refer Table 2)
6. When washing is completed, drain off the washing water by adjusting the knob to "DRAIN" position
7. After the washing water is discharged, turn the knob switch to "HEAVY / NORMAL" position.
8. Fill the water up to the desired level for rinsing.

Note: Water level may be less than the water level line while washing. If so, refill the water. Be careful not to exceed the indicated water level line; it may cause water to spill out of the tub.

Table 1: Detergent Guide

WASH LOAD	3.0 Kg	3.0~4.5 Kg	4.5~6.2 Kg	6.2 Kg or ABOVE
Water Level	LOW	Medium	High	Over Flow
Amount of Detergent	45 gm	55 gm	65 gm	70 gm
Amount of concentrate Detergent	30 gm	35 gm	40 gm	45 gm
Amount of Softener	25 ml	30 ml	35 ml	40 ml

Note : Actual quantities of load may vary depending on the material size of laundry items.

Note : If movement of cloth is too slow, remove some of the cloth until a steady movement is observed.

Table 2: Laundry Guide

Amount of Laundry	Clothes			
	System	Synthetic Fiber	Cotton	Heavy Stained Clothes
Less than 3.0 kg	Washing Time	2 minutes	2-5 minutes	7-10 minutes
	Wash Selector	NORMAL	HEAVY	HEAVY
3.0 ~ 4.0 kg	Washing Time	2-5 minutes	7-10 minutes	10-15 minutes
	Wash Selector	NORMAL	HEAVY	HEAVY
4.0 ~ 5.0 kg	Washing Time	7-10 minutes	10-15 minutes	Wash 15 minutes
	Wash Selector	NORMAL	HEAVY	HEAVY
5.0 kg and above	Washing Time	Wash 0-15 minutes	Wash 15 minutes	Wash 15 minutes
	Wash Selector	NORMAL	HEAVY	HEAVY

RINSING :

1. Fill the water up to desired level depending on cloth load.
2. Set WASH TIMER to 5 ~ 10 min. position to RINSE.
3. When you finish rinsing, drain off the water from the tub by turning the knob to "DRAIN" position.
Transfer clothes to Spin Tub for Spinning.

Spin Shower Rinsing

With spin shower, the remaining detergent in the clothes will be removed and you can save on additional rinsing time and water. (However, if water from the tap contains rust and / or dirt, do not perform spin shower.)

1. Direct water to spin tub by fixing inlet hose to spin water inlet.
2. While SPIN TIMER is at "0" (zero) position (spin tub not rotating), turn on the tap for about 1 minute.
3. Turn OFF the tap and then spin for about 1 ~ 5 minutes.

How to Spin

SPINNING :-

- ✎ Put the laundry into the spinner tub by putting the small-sized laundry in the bottom area to keep the balance of the tub. (figure 1)
- ✎ Place the SPINNER CAP in the tub as shown in the figure 2.
- ✎ Close firmly the inner and outer lids of the spinner tub.
- ✎ Select the spin time to 2 - 5 min.

SPINNING TIME FOR LAUNDRY :-

1. Cotton clothes : 5 min.
2. Delicate clothes (Thin synthetic fiber, sarees etc.) : 2 min.
3. Sweater (Synthetic fiber) : 2 ~ 3 min.
4. Underwear (Knitting clothes) : 3 ~ 5 min.
5. Heavy Clothes (Bed Sheet, Towel etc.) : 5 min.

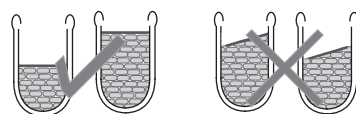

Fig. 1

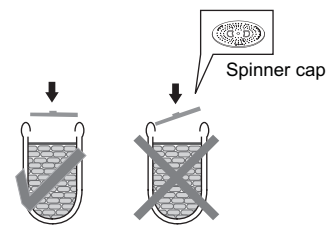

Fig. 2

HINTS FOR SPINNING :-

- ✎ If there is a sound from the spinner, open the spinner lid then try to lay the laundry evenly.
- ✎ If the lid is open while the spinning function is working, the machine will stop within 5 ~ 10 seconds. If it is still running, contact service center.
- ✎ If the spinner lid is not closed, the machine will not work even the timing is set..

In case of the laundry falling from the spinner tub

- ✎ Remove the power plug from main power supply.
- ✎ Open the INNER LID
- ✎ Tilt spinner tub with slight pressure.
- ✎ Pick up the laundry.

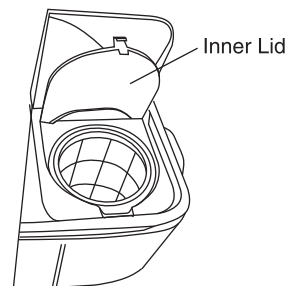

Final step

Empty the spin tub, then turn the drain selector knob to 'WASH' to discharge the washing water and turn the knob to 'Heavy or Normal' when water is completely drain out. Then remove power plug from main power supply.

Care and Maintenance

Be sure to remove the power plug from main power supply before cleaning the machine and filter

How to clean the Lint Filter

1. Pull out the lint filter from the lock, use fingers to press and pull out at the part of the lint filter's side

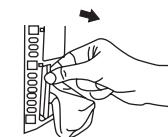

2. Rinse the dirt from the filter with water.



3. Set back to the original position. Insert the bottom first as shown press down and lock as the arrow.

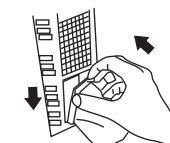

Note : It is recommended to clean the lint filter regularly.

Cleaning the Wash Tub

1. After washing is complete, fill fresh water above the level of pulsator without adding clothes.
2. Run the machine for 1~2 minutes turn the knob to "DRAIN" position when pulsator is still rotating.
3. When water is completely drained out, turn the knob to "Heavy or Normal" position.
4. Finally turn off the machine.

Trouble Shooting

IF ANY ABNORMALITY IS FOUND, CHECK THE FOLLOWING BEFORE CALLING FOR SERVICE CENTER

1. Is the POWER PLUG inserted firmly or POWER PLUG disconnected ?
2. Is the WASH / SPIN TIMER switch turned to "OFF" position ?
3. Is the SPIN LID closed properly ?
4. Is there any laundry fallen out from the SPIN TUB ?

If all the above points have been checked and no abnormality is found but the machine still works improperly, please contact the nearest **SERVICE CENTER**. (Phone nos. mentioned on last page)

{hñgo nw<Om] H\$S nhMmZ

1. dmqeJ_erZ H\$Q'>mob n_jZb
2. dmQ>a gßbmB© H\$ZoŠQ>a
3. dme {bS>
4. dme Q>~
5. Amoda µábmo {µ\$ëQ>a
6. HdS>am\$ nègoQ>a
7. pñnZa {bS>
8. BZa {bS>
9. pñnZ Q>~
10. nmda H\$mS>©
11. S'>oZ hmoµO
12. flifuax dsi

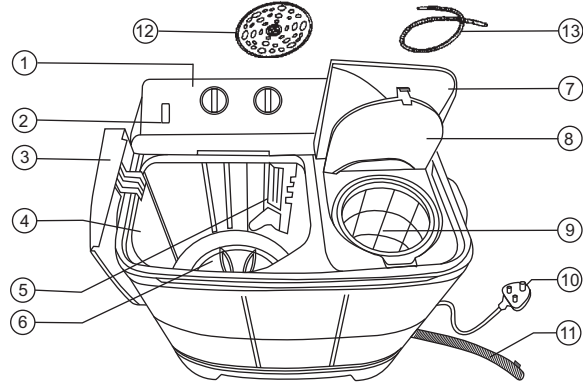

H\$Q'>mob n_jZb H\$S nhMmZ

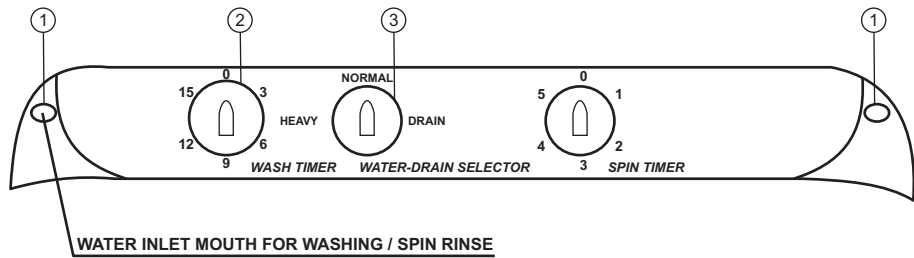

- 1) dmQ>a BZboQ> : dme Q>~ _| nmZr ^aZo Ho\$ {bE ~m`oš, pñnZ Q>~ H\$mO Zb go OmoS>| &
- 2) dme Q>mB©_a : `h YmoZo H\$m g_` {ZYm©[aV H\$aVm h_j & A) YmoZo Ho\$ {bE Q>~ H\$mO _o all Ě& H\$_g_` MwZZo Ho\$ {bE Zm~ H\$mO 10 { ZQ> VH\$ bo OmE Amja _Z Mmho g_` na bo AmE _erZ AnZo Amn ê\$H\$ Om`oJr Ě&
- 3) dme/S'>oZ {gbošQ>a : H\$nS>mo Ho\$ aH\$ma Ho\$ AZwgma dme àmO dme Q>~ H\$m nmZr {ZH\$mbZo Ho\$ {b`o S'>oZ na all &
- 4) pñnZ Q>mB©_a : `h H\$nS>m| H\$mO pñnZ Q>mB©_ H\$mO {ZYm©[aV H\$aVm h_j & H\$_g_` MwZZo Ho\$ {bE Zm~ H\$mO 5 { ZQ> VH\$ bo OmE Amja _Z Mmho g_` na dmng bo AmEš Ě& g_` g_mßV hmoZo na pñnZa Q>~ AnZo Amn ê\$H\$ Om`oJm Ě&

funsZ'k % M^asu ds le;] okW'k çfØ;k dke ugha djrhA
funsZ'k % ukc dks fu/kkZfjr lhek ls T;knk u ?kqek,saA

gwajm Cnm`

_erZ _| H\$n<S>m| Ho\$ Abmdm H\$mO pñnZ Q>~ H\$mO H\$ZongE hñBo Cg_| hmW Z S>mb| Ě&
_erZ H\$mO µlwX XwêšñV `m n[ad{V©g©H\$a|©> bJZo H\$m «IVam hmoVm h_j Ě&
_erZ H\$mO Jrbo `m AmĐ©Vm ^ao dmVnzlaH\$Q> h_oem ~\$X
~mWê\$ _Am{X OJh _| Z all, all ĚAmja ~fm| H\$mO _erZ go
Bg go BboH\${Q'>H\$ emH\$ `m AmJ bJZo H\$m «IVam hmoVm h_j Ě&
«IVam hmo gH\$Vm h_j Ě&

AnZr _erZ H\$mO h_oem g_Vb
«O_rZ na a{|'o Ě& «O_rZ H\$mO
T>bmZ Xmo {S>J«r go H\$ hmo Ě&
_erZ H\$mO hbHo\$ Jrbo H\$n<S>o go gm«\H\$a| Ě&

_erZ AJa H\$manoQ> na alr hmo
Vmo `o gw{ZpíMV H\$a bo {H\$, ~og Ho\$ N>oX ~\$X Z hmšo Ě&

_erZ Ho\$ «H\$ar~ Ábzern
nXmW© Ojgo { _A>r H\$Za/ob
~|«OrZ, n|Q>, {WZa Vm
EoëH\$mohb Z all {oggo
AmJ bJZo H\$m «IVam hmo
gH\$Vm h_j Ě&

pñnZ H\$aZo Ho\$ XmjamZ pñnZ Q>~ _| H\$n<S>ro g_Vb a|Zm
VWm pñnZ H_j\$ñ bJmZm «Oê\$ar h_j Ě&
_erZ _| 50 {S>J«r go. J«o. go Á`mXm Ja_ nmZr Z S>mb|, Bg go _erZ Ho\$ nw<Om] H\$mO hm{Z hmo gH\$Vr h_j Ě&

H\$n<S>| YmoZo Ho\$ ~mX dme Q>~ H\$m nmZr
{ZH\$mbZm «Oê\$ar h_j Ě&
MbVr _erZ Ho\$ {ZMb
{hñgo _| hmW Z S>mb| Ě&
Bg_šo Kw_Zo dmo
Mr«Ooš ahVr h_j\$Ě&

erZ H\$m gšñWmnZ

- 1) erZ H\$mo hdmXma OJh _| al| Ÿ& erZ H\$mo Eogr Q h all Qhm±
 {~Obr H\$m H\$ZoŠeZ Amja nmZr OmZo H\$s C H\$mo Q>«oT>o \Se© na Z al| Ÿ& gy`© H\$s gr AmÐ©Vm go erZ H\$mo Xya al| Ÿ&
- 2) nmda ßB H\$mo gmHo\$Q> _| bJm X| Ÿ&
- 3) <dmQ>a BÝboQ>>> hmo«O H\$mo nmZr Ho\$ Zb go Om«S>|
- 4) S'>oZ nmB©n H\$mo erZ go ~mha {ZH\$mb| Ÿ& gr Ym H\$a b| Vm{H\$ Cg_|
 mo«S> Z ah Om`o Ÿ& Amja Zmbr dm{eSj erZ Ho\$ g`go {Zmbo {hñgo go
 Hw\$N> ZrMr hmoZr Mm{hE, Vm{H\$ nmZr ghr T>§J go njar Vah go {ZH\$b
 gHo\$ Ÿ&
- 5) nhbr ~ma erZ Ho\$ BñVo_mb Ho\$ XmjamZ S'>oZ nmB©n go nmZr ~mha Am
 gH\$Vm hj Ÿ& `h nmZr \j\$ŠQ>ar _| _erZ H\$s\$ Om{H\$ bE BñVo_mb
 {H\$m hpAm hmoVm hj Ÿ&

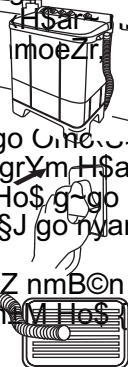

YwbmB© H\$s Vj`mar

- 1) erZ g_Vb OJh na al|
- 2) `h gw{Z{iMV H\$a| {H\$ B©bo[ŠQ`>H\$ H\$ZoŠeZ _| Am{W^J hmo
- 3) S'>oZ hmoO H\$mo ZrMo {bQ>mE|
- 4) dmQ>a BÝboQ> hm«oO H\$mo nmZr Ho\$ Zb go Om«S>|
- 5) H\$N>m| H\$s Oo~ go {gŠH\$m VWm {nZ {ZH\$mbo. CZ_| nS>r {MO| dm°qeJ erZ `m H\$N>m| H\$mo
 ZwH\$gmZ nhp±Mm gH\$Vr hç Ÿ& lmgH\$a {ZH\$mgr nmB©n _| ê\$H\$mdQ> hmo gH\$Vr hj Ÿ&
- 6) H\$N<S>moš Ho\$ d«OZ Amja àH\$ma Ho\$ AZwgma dmQ>a bodb MwZ|
- 7) nmda pñdM H\$mo Mmby H\$a|

YwbmB© H\$m Var«H\$m

- 1) Zm°~ H\$mo ^gSal@ŸkseZy**
- 2) nmZr H\$mo {Zym©[aV ñVa VH\$ ^a b| Ÿ& (_mim Ho\$ {bE Vm{bH\$m 1, 2 n{<T>`o)
- 3) A~ dme Q>~ _| {ZpiMV_mim _| H\$N<S>o S>mboš Ÿ& (_mim Ho\$ {bE Vm{bH\$m 1, 2 n{<T>`o)
- 4) {ZpiMV_mim _| {S>Q>O|Q> H\$mo Q>~ _| S>mb| Ÿ& (_mim Ho\$ {bE Vm{bH\$m 1 n{<T>`o)&
- 5) dme Q>mB©_ H\$mo H\$N<S>mo Ho\$ AmH\$ma Amja àH\$ma Ho\$ AZwgma
- 6) YwbmB© hmoZo na Zm°~ H\$mo S'>oZ na aH\$a nmZr ~mha {ZH\$mb| Ÿ&
- 7) nmZr {ZH\$bZo Ho\$ ~mX Zm°~ H\$mo ^gSoh@ukseZy** fLFkfr esa yk,iA
- 8) IŠJmbZo Ho\$ {bE {\\$ago nmZr ^a| Ÿ&

ZmoQ> : H\$N<S>o YmoVo g_` {Zym©[aV H\$r hpB© gr_m go «A`mXm nmZr Z ^a| Ÿ& Bggo nmZr Q>~ Ho\$ ~mha AmZo H\$s
 gŠ^mdZm hj Ÿ&

Vm{bH\$m - 1

H\$N<S>o	3.0 {H\$bmo	3.0-4.5 {H\$bmo	4.5-6.2 {H\$bmo	6.2 {H\$bmo
nmZr H\$m ñVa	bmo	_r{S>`_	hmB©	Amoda àbmo
{S>Q>O Q> H\$s_mim	45 J«m_	55 J«m_	65 J«m_	70 J«m_
H\$gŠQ`>oQ> {S>Q>O Q> H\$s_mim	45 J«m_	55 J«m_	65 J«m_	70 J«m_
gmâQ>Za H\$s_mim	25 {_.br.	30 {_.br.	35 {_.br.	40 {_.br.

H\$N<S>moš H\$s_mim H\$N<S>moš Ho\$ AmH\$ma Ho\$ AZwgma AbJ AbJ hmo gH\$Vr hj &
 `X H\$N<S>o R>rH\$ T>§J go Zhr Ky_Vo Vmo Hw\$N> H\$N<S>o {ZH\$mb brOrE Ÿ&

Vm{bH\$m - 2

H\$N<S>moš H\$N<S>o	H\$N<S>moš Ho\$ AmH\$ma	H\$N<S>moš Ho\$ AZwgma	Amja àH\$ma na {Z^©a H\$aVm hj Ÿ&
3 {H\$bmo go H\$	YwbmB© H\$m{gZQ>	2-5 {_ZQ>	7-10 {_ZQ>
	dme {gboŠQ>a keZy	gSoh	ñQ`m±J
3.0 ~ 4.0 {H\$bmo	YwbmB© H\$m{gZQ>	7-10 {_ZQ>	10-15 {_ZQ>
	dme {gboŠQ>a keZy	gSoh	gSoh
4.0 ~ 5.0 {H\$bmo	YwbmB© H\$m{gZQ>	10-15 {_ZQ>	dme15 {_ZQ>
	dme {gboŠQ>a keZy	gSoh	gSoh
5.0 {H\$bmo go «A`mXm	YwbmB© H\$m{gZQ>	10-15 {_ZQ>	dme15 {_ZQ>
	dme {gboŠQ>a keZy	gSoh	gSoh

Agbr ^ma H\$N<S>moš Ho\$ AmH\$ma Amja àH\$ma na {Z^©a H\$aVm hj Ÿ&

IŠJmbZm :

- H\$N<S>mo Ho\$ AZwgma nmZr H\$m ñVa Mw{Z`| Ÿ&
- dme Q>mB_a Zm°~ H\$mo Ho\$ ~rM al| Ÿ&
- IŠJmbZo H\$s à{H«\$`m H\$s g_m{ßV na S'>oZ {gboŠQ>a H\$mo S'>oZ H\$s pñW{V _| Kw_mE
- H\$N<S>mo H\$mo pñZ Q>~ _| ñWmŠV[aV H\$a| Ÿ&

pñnz emda [apÝg˘J (A{V[aŠV IŠJmbZm)

- IŠJmbZo HŠs à{H«\$`m Ho\$ HŠm AmzBq A`mXm à^md IŠJmbZo Ho\$ {bE HŠa gHŠVo`h; Ý&
- pñnz Q>~ _| HŠnS>m| HŠboŷ; mZ êšn go
- pñnz Q>~ _| dmQ>a gßbm` Ho\$ {bE okWVj llykbZ ikbZi dks fLiu buysV esa yxk;saA
- pñnz Q>mB©_a HŠmo o na bm`o Ý&
- nmZrrHŠ gßbmB© 1 {_ZQ> Ho\$ {bE Mmby HŠa| Ý&
- nmZr HŠs gßbmB© ~ŠX HŠao ÝAmja pñnz Q>HŠboŷ; mZ êšn go

HŠn<S>o gwlmZo HŠo\$ XmjamZ

- pñnz Q>~ _| N>moQ>o HŠnS>o ZmMŠ; AmŠaBogpñnz Q>~ _| ^ao Ý&
- ZMo {Xln` {Ml Ho\$ AZwgHŠmŠZ JmE Ý&
- BZa Š> Amja pñnz HŠa VamŠ; JmE Ý&
- pñnz Q>ZmŠmo 2 ZQ>a al| Ý&

HŠn<S>o gwlmZo HŠm g_`

- gyVr HŠn<S>o - 5 {ZQ> 4) AŠS>a doAa - 3~5 {_ZQ>
- ZmOwHŠ ({gÝWo{Q>HŠZGŠn<S>})moQ>o gyVr HŠn<S>_oZQ>
- Džr HŠaŠ> - 1~2 {ZQ>

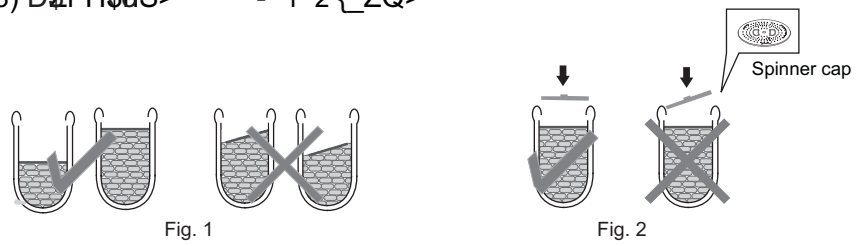

pñnzQJ Ho\$ {bE {Q>Bn{U`mŠ

AJa _erZ_ | HŠnZ hmo ah hpnZno gHŠmŠbŠmŠ
 pñnz Q>~ _| HŠnS>m| HŠboŷ; mZ êšn go
 X Eigm Zht hmoVm hj Vmo g{d@g glQ>a go gŠnH©\$ HŠa| Ý&
 pñnz Q>HŠmo R>HŠ Vah go ~ŠX Z HŠaZo na pñnzQJ Zhr hmoJr Ý&

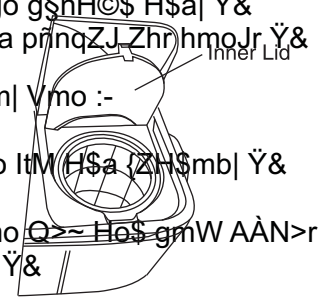

- AJa HŠn<S>o pñnz Q>~ go ZrMo {Ja J`o hml Vmo :-
- nmda BbJ HŠmo {ZHŠmboŠ Ý&
- BZa {bS> Amja AmDŠQ>a Q>~ HŠda HŠmo ItM(HŠa {ZHŠmb| Ý&
- \Šgo hpE HŠn<S>o {ZHŠmb| Ý&
- AmDŠQ>a Q>~ HŠda Ho\$ g^r hpHŠm| HŠmo Q>~ Ho\$ gmW AÀN>r Vah
- ~ŠX HŠaVo hpE dmng AnZr OJh na bJm X| Ý&
- Cn`moJ Ho\$ ~mX :-
- pñnz ~mñHo\$Q> go gmao HŠn<S>o ~mha {ZHŠmb| ÝAmja pñnz S`>mB© HŠda ~ŠX HŠa|
- nmda HŠmS>© HŠmo gmHo\$Q> go {ZHŠmb| Ý&

gwajm Amja Xol^mb

_erZ Amja {ŠQ>a HŠs g\ŠmB© HŠaZo go nhbo `h gw{Z{iMV HŠa boZm Mm{hE {HŠ, nmda B
 hwB© nmda HŠmS>© {ZHŠmbr hj `m Zht ? nmda HŠmS>© g\ŠmB© go nhbo {ZHŠmb boZr Mm

{bŠQ> {ŠQ>a HŠs g\ŠmB© HŠgo HŠa| ?

- bmHŠ go qbQ> {ŠQ>a ItMHŠa ZHŠm{bE Ý&
 {bŠQ> {ŠQ>a Ho\$ ~m<Oy Ho\$ Šna HŠm nw<Om©
 CŠJ|b`moŠ go X~mB©`o Amja ItMHŠa {ZHŠm{b`o Ý&
- {ŠQ>a HŠs Ombr HŠmo CēQ>r {Xem |_mo<S>|
 Amja qbQ> {ZHŠmbo Š& Ombr HŠmo nmZr go gm\Š HŠa| Ý&
- {Ša go CgHŠmo nhbr OJh na nyd©
 {ñW|V_|{~R>mB©`o Oigm ~Vm m J`m
 hj Cgr aHŠma ZrMo HŠm {hñgr nhbo
 AŠXa {~R>mB©`o Ý& Vra Ho\$ ZmZ go ~Vm`o
 J`o Var<Ho\$ go ZrMo X~mHŠa bmHŠ HŠa XrOr`o Ý&

ZmoQ> - qbQ> {ŠQ>a HŠs Ombr HŠs g\ŠmB© {Z`m_rV êšn go HŠaZm Mm{hEo Ý&

dm°e Q>~ HŠs g\ŠmB© Ho\$ {bE -
 1) dm°qeJ à{H«\$`m nyar hmoZo Ho\$ ~mX dm°e Q>~ _| nēgoQ>a bodb Ho\$ Cna VHŠ
 Cg_| HŠnS>| Z S>mb| Ý&
 2) 1~2 feuV okWf`kax čfØ;k pkyw j[ksaA ckn esa ukWc dks ^M°su* iksft'ku esa ?kqek;saA
 3) ikuh dks iwjk fudyus ds ckn ukWc dks ^^gSoh@ukseZy** fLFkfr ij yk;saA
 4) Am{la _| _erZ ~ŠX HŠa| Ý&

g ñ`m VWm Cnm`

- Om±M boZm Mm{h`o Y&
 1) nmda H\$mS>© R>rH\$ T>§J go bJmB© h_j `m Zht `h Om±M br[O`o Y&
 2) dme / pñnZ Q>mB©' aH\$m pñdM/Añññ\$ H\$Om±M b`
 3) pñnZ H\$m T>SH\$Z Rr>H\$ T>§DgY & SX h_j `h Om±M b`
 4) pñnZ Q>~ go H\$mB© H\$ñ<S>m ZrMoy&

Om±M {b`o J`o Amja {Sa ^r <lam~r Z<Oa AmVr h_j Om±M b`
 RrH\$ T>§J go H\$m_ Zhr§ H\$a ahr h_j Vmo H\$ñ`m g{d©g g|Q>a go g\$ñH©\$ H\$a| Y&

SPECIFICATION

MODEL :	XPB62-0613HB XPB62-0613RU XPB62-0613AQ XPB62-0613CG
Power Supply	240V, 50 Hz AC
Washing Capacity	6.2 Kg
Water Level	Max. 65 Litres* Min. 38 Litres
Rated Power Consumption	Wash : 300 Watts Spin : 200 Watts
Weight of the Machine	19.0 kg
Overall Dimensions	Length 725 mm Width 430 mm Height 880 mm
Washing Method	Quadra Pulsator
Washing Time	15 Min Wash

As per Standard Testing Condition.
 * Max. Water level at max. level.



Customer Name.....Address.....
 Serial No.....Date of Purchase.....Model No.....
 Dealer Seal.....

HAIER WARRANTY

HAIER APPLIANCES (INDIA) PVT. LTD. (hereinafter referred to as "the Company") hereby offers the following warranty to the original domestic purchaser commencing from the date of the purchase. The Company, at its sole discretion, will free of charge repair or replace any defective part of parts which prove to be defective in workmanship and/or materials and not due to abnormal or improper usage.

CONDITIONS OF WARRANTY

- This warranty will automatically terminate on the expiry of the warranty period from the date of delivery.
- The Company is not liable for any delay in servicing due to reasons beyond the control of the Company or any of its authorised service centres.
- Parts replaced or repaired under this warranty are warranted throughout the remaining of the original warranty period.
- It is entirely left to the Company's discretion to repair/replace parts at the site of installation or at the authorised service centre of the Company.
- This warranty shall be strictly limited to the repairs or replacement of defective parts specified in the warranty. This warranty shall not cover any consequential or resulting liability.
- This warranty shall not, in any case, extended towards payment of any monetary consideration whatsoever or replacement or return of the product.
- The Company may repair/supply parts free of cost during the warranty period. This warranty does not cover any Excise duty, Central or Sales tax, Octroi and other local taxes or levies on the components/parts.
- The parts shall be replaced by functionally operating equivalent material only and not with brand new ones and are likely to be different from the one originally fitted. The parts thus removed shall be taken back by the Company.
- The Company reserves the right to retain any part or component replaced at its sole discretion during the warranty period.
- In no event the Company or its authorised service centre be liable for any consequential damages or resulting liability, damage or loss arising directly or indirectly out of any defect in the product.
- This warranty is not valid in case of the following events :
 - If the Product has been Installed/Service/Repaired/Opened or Tampered by any unauthorised personnel.
 - If defects arise/caused by accidents, alteration, misuse, neglect, substitution of original components with spurious/non-genuine components, attacked by household pest/rodents, fire, flood, earthquake, lightning and/or any other act of God/natural calamities.
 - The product is shifted outside India.
- For any service under this warranty beyond city/town/municipal limits from the Company/authorises service centre, a fixed charge of Rs. 50 will be collected from the customer in addition to the actual to and fro charges by the shortest route.
- Any change of location or change in the ownership during the warranty period must be intimated in writing to the Company.
- The Company's employees or its authorised representatives have no authority to vary the terms of the warranty.
- This warranty is effected in New Delhi and claims, if any, shall be made only before the courts having jurisdiction in New Delhi and no claim shall be made against the Company outside New Delhi not with standing that the Appliance may have been sold or delivered elsewhere.

Product	Warranty	
	Period	Parts not covered
Colour TV	12 Months	Remote, Cabinet
Refrigerator	Comprehensive:12 Months Compressor: 60 Months	Plastic, Glassware, Light Bulb
Washing Machine	Comprehensive:24 Months Motor: 30 Months	Top, Lid, Outer Casting
Airconditioner	Comprehensive:12 Months Compressor: 60 Months	Air Filter, Front Grill
Microwave	12 Months	Glass, Plate, Bulb
Dishwasher	24 Months	
Cloth Dryer	12 Months	
DVD	12 Months	

HAIER APPLIANCES (INDIA) PVT. LTD., B-1/A-14, Mohan Co-operative Industrial Estate, New Delhi-44
 Ph.: 011-3067 4000/5000. Fax: 011-26971562



Customer Name.....Address.....
 Serial No.....Date of Purchase.....Model No.....
 Dealer Seal.....