

ZANUSSI

 **Electrolux**

WASHING MACHINE
ZWF 1240 W - ZWF 1440 W
ZWF 1640 W - ZWF 1640 S

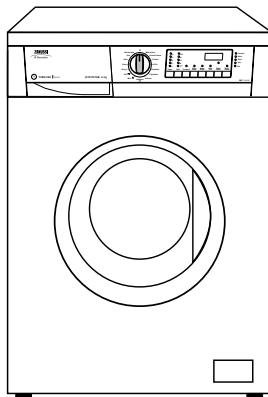

 Quick Installation Guide:

visit our WEB SITE to view an install video

www.video.uk.electrolux.com



Important Safety Information

It is most important that this instruction book should be retained with the appliance for future reference. Should the appliance be sold or transferred to another owner, or should you move house and leave the appliance, always ensure that the book is supplied with the appliance in order that the new owner can get to know the functioning of the appliance and the relevant warnings.

These warnings have been provided in the interest of safety. You **MUST** read them carefully before installing or using the appliance.

Installation

- This appliance is heavy. Care should be taken when moving it.
- It is dangerous to alter the specifications or attempt to modify this product in any way.
- All packing and transit bolts must be removed before use. Serious damage can occur to the product and to property if this is not adhered to. See relevant section in instructions.
- Any plumbing work required to install this appliance should be carried out by a qualified plumber or competent person.
- Any electrical work required to install this appliance should be carried out by a qualified electrician or competent person.
- Care must be taken to ensure that the appliance does not stand on the electrical supply cable.
- If the machine is situated on a carpeted floor, please adjust the feet in order to allow air to circulate freely.

Child Safety

- This appliance is designed to be operated by adults. Children should not be allowed to tamper with the controls or play with the product.
- Pets and children have been known to climb into washing machines. Please check your drum before use.
- The glass door becomes very hot during the washing cycle. Keep children away from the vicinity of the appliance whilst it is in operation.
- Keep all packaging well away from children.
- Keep all detergents in a safe place out of children's reach.

Use

- Always unplug the appliance and turn off the water supply after use.
- Do not overload the appliance. See relevant section in the instruction book.
- Only wash fabrics which are designed to be machine washed. If in doubt, consult the care label on the clothes.
- Before washing, ensure that all pockets are empty and buttons and zips are fastened. Avoid washing frayed or torn articles and treat stains such as paint, ink, rust, and grass before washing. Underwired bras must NOT be machine washed.
- Any objects such as coins, safety pins, nails, screws, stones or any other hard, sharp material can cause extensive damage and must not be placed into the machine.
- Garments which have been in contact with volatile petroleum products should not be machine washed. If volatile cleaning fluids are used, care should be taken to ensure that the fluid is removed from the garment before placing in the machine.
- Wash small items such as socks, laces, washable belts etc in a washing bag or pillow case as it is possible for such items to slip down between the tub and the inner drum.
- Only use the advised quantities of fabric softener. Damage to the fabric can ensue if you over-fill. Refer to the manufacturer's recommendations of quantities.
- As some duvets and eiderdowns should be washed in large commercial machines because of their bulk, please check with the manufacturer of the item before washing in a domestic machine.
- Leave the porthole door slightly ajar between washes to preserve the door seal.
- Under no circumstances should you attempt to repair the machine yourself. Repairs carried out by inexperienced persons may cause injury or serious malfunctioning. Contact your local Service Force Centre. Always insist on genuine spare parts.

Contents

For the User

| | | | |
|--|-------|------------------------------------|-------|
| Important Safety Information | 2 | Maintenance and Cleaning | 18-19 |
| Your New Washing Machine | 4 | Descaling | 18 |
| Description of the Appliance | 5 | After each wash | 18 |
| Detergent dispenser drawer | 5 | Maintenance Wash | 18 |
| Child safety feature | 5 | External cleaning | 18 |
| The Control Panel | 6-9 | Cleaning the dispenser drawer | 18 |
| Operating sequence | 10-12 | Cleaning the drawer recess | 18 |
| Load the laundry | 10 | Cleaning the pump | 18-19 |
| Measure out the detergent | 10 | Cleaning the water inlet filter | 19 |
| Measure out the fabric softener | 10 | The dangers of freezing | 19 |
| Switch the machine on | 10 | Emergency emptying out | 20 |
| Select the desired programme | 10 | Something Not Working | 21-22 |
| Select the temperature | 10 | Service and Spare Parts | 22 |
| Select the spin speed or the RINSE HOLD option | 11 | Guarantee Conditions | 23 |
| Select the desired options | 11 | For the Installer | |
| Select the DELAY START | 11 | Installation Instructions | 24 |
| Start the programme | 11 | Technical Specifications | 24 |
| How to change a programme during its cycle | 11 | Unpacking | 25 |
| How to interrupt a programme during its cycle | 11 | Positioning | 25 |
| How to cancel a programme during its cycle | 12 | Installation on a suspended floor | 25 |
| How to open the door during the cycle of a programme | 12 | Water inlet | 26 |
| End of programme | 12 | Water drainage | 26-27 |
| Washing Hints | 13-14 | Levelling | 27 |
| Which detergent?.... | 14 | Special conditions | 27 |
| And in which form? | 14 | In the interest of the environment | 28 |
| Wash Care Symbols | 15 | Electrical connection | 28 |
| Washing Programmes | 16-17 | Permanent connection | 29 |

Guide to use the Instruction Book

The following symbols will be found in the text to guide you throughout the instructions:



Safety instructions



Hints and tips



Environmental information

Your New Washing Machine

Your new washing machine, which is fitted with the New Jet System, meets all modern requirements for effective treatment of laundry with low water, energy and detergent consumption.

Even small loads are washed “economically” because the amount of water used is regulated automatically according to the load and type of fabric.

- **Automatic cooling of the wash water to 60°C** before draining, with the 90°C programme. This reduces thermal shock to fabrics, helping to prevent creasing.
- **The special wool programme** with its new delicate wash system treats your woollens with extreme care.
- **The balance control device** ensures that the washing machine remains stable when spinning.

Ecological hints

To save water and energy and help protect the environment, we recommend that you follow these hints:

- Normally soiled laundry may be washed without prewashing in order to save detergent, water and time (the environment is protected too!).
- The machine works more economically if it is fully loaded.
- With adequate pre-treatment, stains and limited soiling can be removed; the laundry can then be washed at a lower temperature.
- Measure out detergent according to the water hardness, the degree of soiling and the quantity of laundry being washed.

Important

Your machine is fitted with a balance control device, which ensures the machine is stable during the spin.

If the wash load appears not to have been spun sufficiently at the end of the wash cycle, because it is not evenly distributed in the drum, the balance control device may have operated. It will therefore be necessary to redistribute the wash load manually and select a spin programme. For more detailed information see the section headed “Something Not Working”.

In the interest of the environment

- Materials marked with the symbol  are recyclable.
- Check with your local Council or Environmental Health Office to see if there are facilities in your area for re-cycling this appliance.
- When the appliance is to be scrapped, cut off the power supply cable and make the door lock device unusable to prevent young children from being trapped inside.
- Help to keep your country tidy - use authorised disposal sites for your old appliance.



**How do we help to protect the environment?
We use recycled paper!**

Description of the Appliance

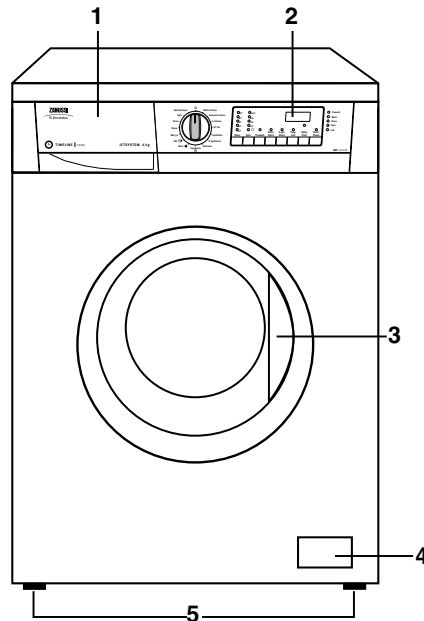
- 1 Detergent dispenser drawer
- 2 Control panel
- 3 Door opening handle
- 4 Drain pump
- 5 Adjustable feet



Detergent dispenser drawer

-  Prewash
-  Main wash
-  Fabric softener

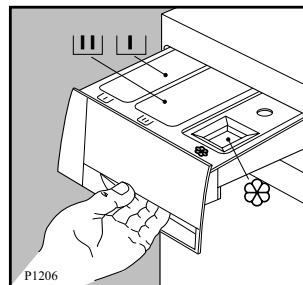

Child safety feature

This machine incorporates a special child safety feature to prevent small children from being trapped inside the machine.

To activate this device, rotate the button (without pressing it) inside the door clockwise until the groove is horizontal. If necessary use a coin.

To disable this device and restore the possibility of closing the door, rotate the button anti-clockwise until the groove is vertical.

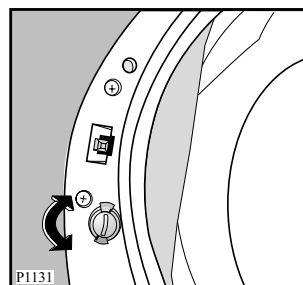

The Control Panel

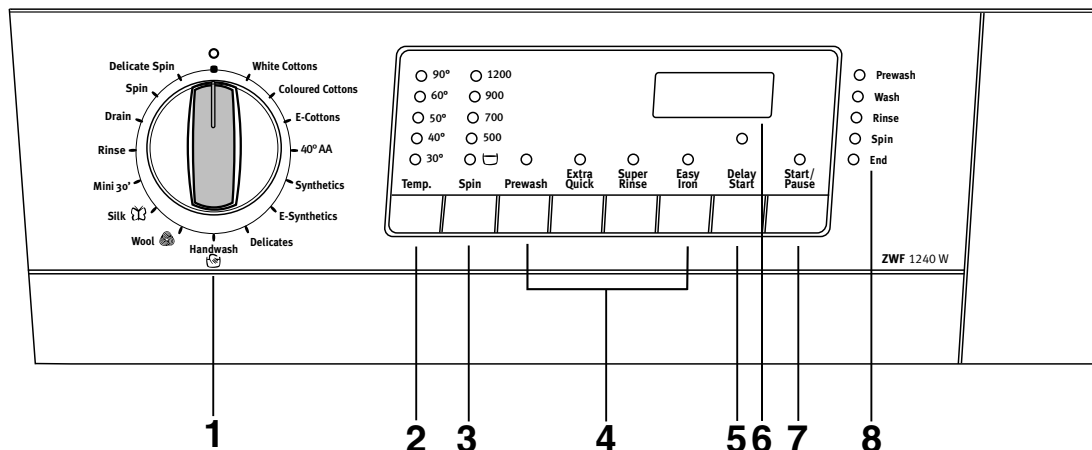

1 Programme selector dial

The selector dial is divided into following sections:

- Cotton, linen
- Synthetics
- Delicates, handwash, wool, silk and mini-programme, rinses, drain, spin and delicate spin

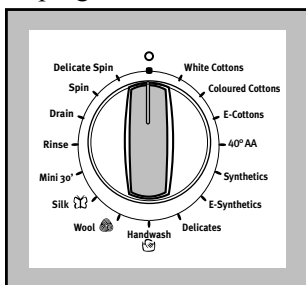

The selector dial can be turned either clockwise or anticlockwise.

Position **E-Cottons** corresponds to the ENERGY SAVING programme for cotton and position **O** to Reset programme/Switching OFF of the machine.

At the end of the programme the selector dial must be turned to position **O**, to switch the machine OFF.

2 TEMPERATURE button "Temp."

Press this button repeatedly to increase or decrease the temperature, if you want your laundry to be washed at a temperature different from the one proposed by the washing machine.

Maximum temperatures are 90°C for white cotton, 60°C for coloured cotton and synthetic fabrics, 40°C for delicate fabrics, wool and fabrics to be hand-washed, 30°C for silk and «Miniprogramme».

3 Spin speed button "Spin"

Press this button repeatedly to change the spin speed, if you want your laundry to be spun at a speed different from the one proposed by the washing machine. The relevant light will light up. Maximum speeds are:

- for cotton: 1200 rpm for model ZWF 1240 W; 1400 rpm for model ZWF 1440 W; 1600 rpm for models ZWF 1640 W and ZWF 1640 S;
- for synthetic, wool, and fabrics to be handwashed: 900 rpm
- for delicate, silk fabrics, miniprogramme: 700 rpm

Rinse hold position : when you choose this option, the machine will not drain the water of the last rinse, so as not to crease the laundry.

At the end of the cycle, the light of the START/PAUSE button goes off, the light  and the "End" pilot light remain lit, a flashing zero appears on the display, to indicate that the water must be drained.

There are 2 possibilities to empty out water:

- Select programme "Drain":

The water is emptied out without spinning.

- Select programme "Spin" or "Delicate Spin". Select the spin speed by means of the relevant button and then depress the START/PAUSE button. The water is emptied out and the laundry is spun at the selected spin speed.

Attention! Before selecting "Drain", the "Spin" or the "Delicate Spin" programme the selector dial has to be positioned on **O** (cancelling).

4 OPTION buttons

Depending on the programme, different functions can be combined. These must be selected after choosing the desired programme and before depressing the START/PAUSE button.

When these buttons are pressed, the corresponding pilot lights come on. When they are pressed again, the pilot lights go out.

If an incorrect option is selected, the pilot lights flash for about 2 seconds and the message Err is displayed.

Press these buttons to select the following options:

- **PREWASH:** select this option if you wish your laundry to be prewashed before the main wash (not available for wool and handwash cycle, miniprogram and silk). The Prewash ends with a short spin at 650 rpm in programmes for cotton and synthetic fabrics, whereas in the programme for delicate fabrics the water is only drained.
- **EXTRA QUICK:** this option can be used for lightly soiled (not for wool, hand wash, silk and miniprogramme) in order to obtain a good washing programme in a short time. The washing time will be reduced according to the type of fabric and the selected temperature.

“Extra Quick” cannot be used with E-Cottons, 40° AA, E-Synthetics programmes.

- **SUPER RINSE:** this option can be selected with all programmes, except the wool programme and handwash. The machine will add 2 rinses for cottons and 1 rinse for synthetics, delicates and silk. This option is recommended for people who are allergic to detergents, and in areas where the water is very soft.
- **EASY IRON:** selecting this button the laundry is gently washed and spun to avoid any creasing. In this way ironing is easier. Furthermore the machine will perform 6 rinses instead of 3 for cotton and 4 rinses instead of 3 for synthetics. This function can be used for cotton and synthetic fabrics.

If this option is selected for cotton programmes, the spin speed automatically will reduce to 900 rpm.

If this option is selected for synthetic programmes with a temperature of 60°C or 50°C, the machine will perform a washing cycle at max 40°C.

5 DELAY START button

The wash programme can be delayed from 30 min - 60 min - 90 min, 2 hours and then by 1 hour up to a maximum of 23 hours by means of this button.

Selecting the delayed start

- Select the programme and the required options.
- Select the delay start.
- Depress START/PAUSE button: the machine starts its hourly countdown.

The programme will start after the selected delay has expired.

DELAY START cannot be used with “Drain”, “Spin” or “Delicate spin”.

Cancelling the delayed start

- Depress START/PAUSE button.
- Depress DELAY START button until “0” is displayed.
- Depress START/PAUSE button again.

6 DISPLAY

The display shows the following information:

Duration of the programme - Delayed start - Incorrect option selection - Alarm code - End of programme.

Duration of the selected programme

After selecting a programme, the duration is displayed in hours and minutes (for example 2.05).

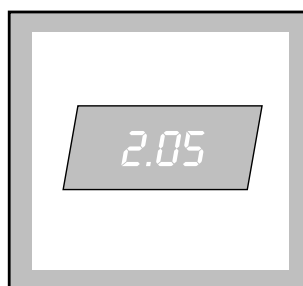

The duration is calculated automatically on the basis of the maximum recommended load for each type of fabric.

After the programme has started, the time remaining is updated every minute.

Delayed start

The selected delay (23 hours max) set by means of the relevant button appears on the display for 3 seconds, then the duration of the previously selected programme is displayed.

The countdown is updated every hour and when remain the last 2 hours each 30 min.

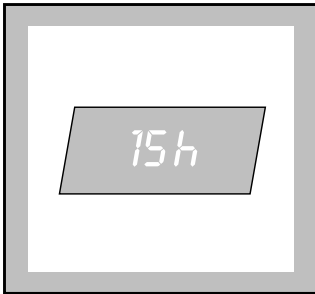

End of programme

When the programme has finished a **flashing zero** is displayed.

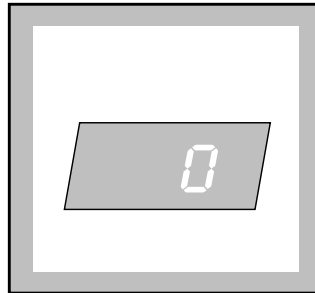

Incorrect option selection

If an option which is not compatible with the set wash programme is selected, the message **Err** is displayed for 2 seconds.

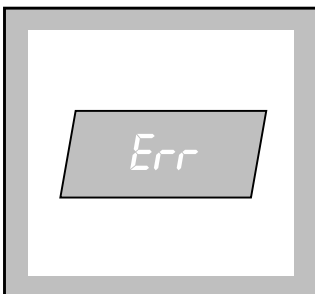

7 START/PAUSE button

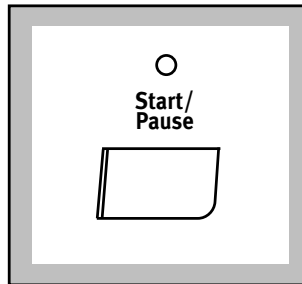

This button has two functions: Start - Pause.

- **Start:**

After having selected the required programme, press this button to start the machine; the corresponding pilot light stops flashing.

If you have selected the delayed start, the machine begins its countdown. The duration of the programme or the delay appears on the display.

- **Pause**

To interrupt a programme which is running, depress the Start/Pause button: the corresponding pilot light starts to flash.

To restart the programme from the point at which it was interrupted, press the START/PAUSE button again.

Alarm codes

In the event of operating problems, some alarm codes can be displayed, for example E20 (see paragraph "Something not working").

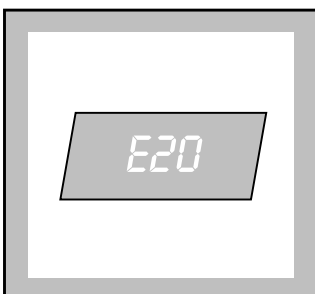

8 Programme phase indicator lights

By selecting the wash programme, the pilot lights corresponding to the various phases making up the programme come on.

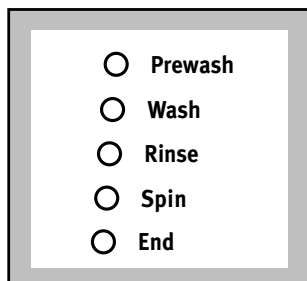

After you have started the programme, only the light relevant to the phase that is currently being carried out will remain lit.

At the end of the programme the “End” pilot light illuminates.

The “End” pilot light flashes in the event of operating problems. And the relative alarm code appears on the display.

E10 = the machine does not fill

E20 = the machine does not empty

E40 = the door has not been closed

To eliminate the problem, see paragraph “Something not working”.

Programme information

Rinse

With this programme it is possible to rinse and spin cotton garments which have been washed by hand. The machine performs 3 rinses, followed by a final spin at maximum speed. The spin speed can be reduced by depressing “Spin” button. The final spin is foreseen only for cotton items as in the spin programme.

Drain

For emptying out the water of the last rinse in programmes with the Rinse hold .

Turn first the programme selector dial to **O**, then select programme “Drain” and depress the START/PAUSE button.

Spin

Separate long spin at max.speed for hand washed garments. Use this for cotton items. You can reduce the speed by means of “Spin” button to adapt it to the fabrics to be spun.

Delicate Spin

Separate short spin at 700 rpm for hand washed garments. Use this for synthetic, delicate, wool/handwashed, silk items. You can reduce the speed by means of “Spin” button to adapt it to the fabrics to be spun (only in the model ZWF 1240 W).

Mini 30'

This is a complete programme that can be combined with the following options: spin speed reduction (only in the model ZWF 1240 W), rinse hold and delayed start.

To be used for laundry which is lightly soiled or which needs freshening up.

Max load 3 kg;

Washing temperature 30°C

Programme duration 30 minutes

Final spin speed 700 r.p.m.

O = Cancelling/OFF

To reset a programme and to switch off the machine turn the selector dial to **O**. Now a new programme can be selected.

i Operating Sequence

Before the first wash we recommend to run a cotton cycle at 60°C, with the machine empty, in order to remove any manufacturing residue from the drum and tub.

Pour half a measure of detergent into the main wash compartment and start up the machine.

1. Load the laundry

Open the door by carefully pulling the door handle outwards..

Place the laundry in the drum, one item at a time, shaking them out as much as possible.

Close the door.

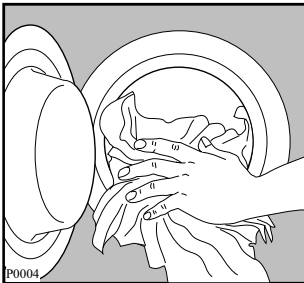

2. Measure out the detergent

Pull out the dispenser drawer until it stops. Measure out the amount of detergent required and pour it into the main wash compartment  .

If you wish to carry out the prewash, pour detergent into the appropriate compartment marked  .

3. Measure out the fabric softener

If required, pour fabric softener into the compartment marked  , **without exceeding the «MAX» mark.**

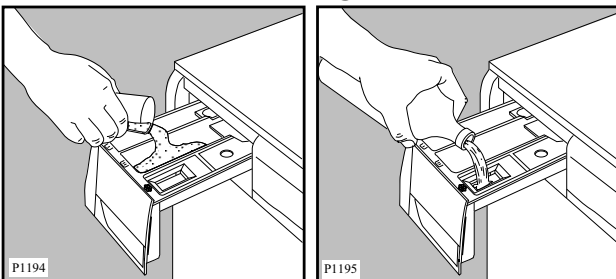

Close the drawer gently.

4. Switch the machine on

Turn the selector dial to the desired programme to switch the appliance on.

To switch the appliance off turn it to **O**.

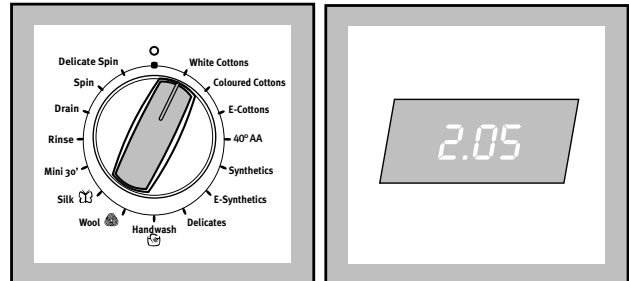

5. Select the desired programme

Turn the selector dial to the desired position: the lights corresponding to the different phases making up the selected programme illuminate.

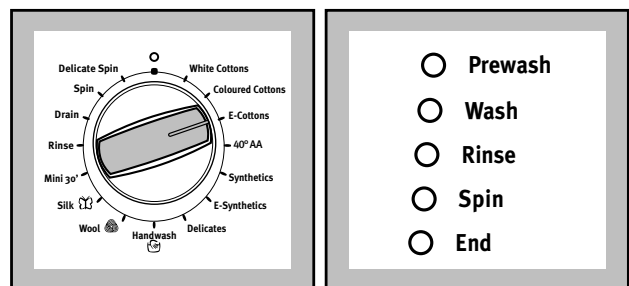

The duration of the programme appears in the display.

6. Select the temperature

Press the “Temp.” button if you wish to select a temperature value different from the one proposed by the washing machine. The relevant light will light up.

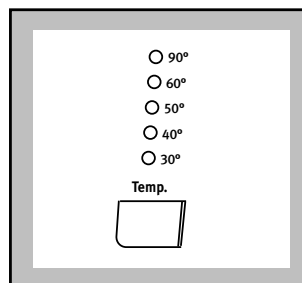

7. Select the spin speed or the RINSE HOLD option

Press the “Spin” button repeatedly, in order to select the desired spin speed or the  option. The relevant light will light up.

If you select the  option, the machine will stop at the end of the programme with the water still in the tub.

ZWF 1240 W

ZWF 1420 W

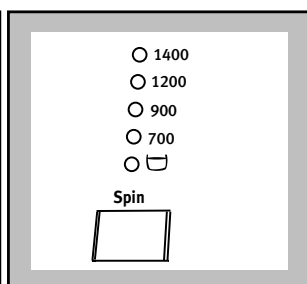
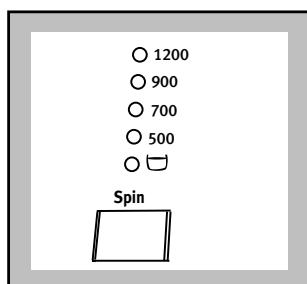

ZWF 1640 S - ZWF 1640 W

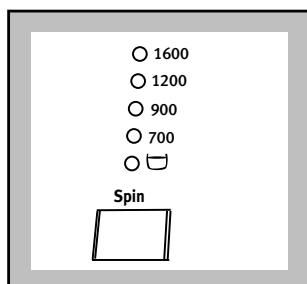

8. Select the desired options

If your laundry is very dirty, it may be advisable to select the “Prewash” option.

If you wish the laundry to undergo an extra rinse, select the “Super Rinse” option.

If your laundry is only slightly soiled, select the “Extra Quick” option.

Selecting the “Easy Iron” option your laundry is gently washed and spun to avoid any creasing.

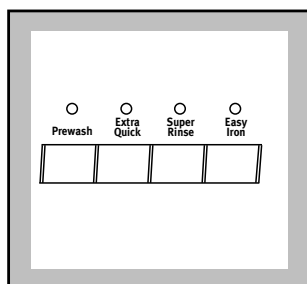

Select the OPTIONS button so as to cause one or few lights to light up.

9. Select the DELAY START

To delay starting of the programme, press the DELAY start button. The figures corresponding to the selected delay will be displayed for about 3 seconds, after which the duration of the selected programme will appear on the display.

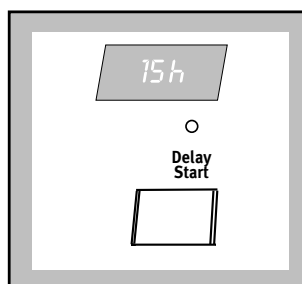

During this period it is possible to load other laundry:

- depress START/PAUSE button;
- load the laundry;
- close the door and depress START/PAUSE button again.

10. Start the programme

Press the START/PAUSE button. The relevant light will stop flashing, and only the light relevant to the phase that is in progress will remain lit.

If you have chosen a delayed start, the washing machine will begin the countdown.

The display will show the duration of the programme or the selected delay.

11. How to change a programme during its cycle

You can alter the programme before it starts.

When the programme has started, you can only reset it by turning the programme selector dial to O and then you can select the new programme. Start it by depressing the START/PAUSE button.

12. How to interrupt a programme during its cycle

Depress the START/PAUSE button to interrupt a programme which is running, the corresponding light starts to flash. Depress the same button again to restart the programme.

I 3. How to cancel a programme during its cycle

Turn the selector dial to **O** to cancel a programme which is running. Now you can select a new programme. The water in the drum will be not emptied out.

I 4. How to open the door during the cycle of a programme



First set the machine to PAUSE by pressing the START/PAUSE button.

If the door does not open, this means that the machine is already heating, that the water level is above the bottom edge of the door or that the drum is turning.

If you cannot open the door but you need to open it you have to switch the machine off turning the selector dial to **O** . After about 3 minutes the door can be opened (pay attention to the water level and temperature!). To restart the programme switch on the machine and select again the desired programme and options.

I 5. End of programme

The washing machine stops automatically.

If the Rinse hold  option has been selected, the light of the START/PAUSE button goes off, the light  and the “End” pilot light remain lit to indicate that the water must be drained before opening the door. The display shows a flashing zero.

To empty out the water you can select programme “Drain”, the water is emptied out without spinning or select programme “Spin” or “Delicate Spin”. Select the spin speed by means of the relevant button and then depress the START/PAUSE button. The water is emptied out and the laundry is spun at the selected spin speed.

Turn the programme selector dial to Reset **O** to switch the machine off.

Remove the laundry from the washing machine.

Check whether the drum is completely empty, by rotating it with your hand. The purpose of this is to prevent any items of laundry from remaining accidentally in the drum, where they might get damaged in a subsequent wash (e.g. by shrinking) or bleed colour into another load of laundry.

We advise you to close the water supply tap and disconnect the plug from the socket.

Leave the door ajar in order to air the washing machine.

Washing Hints

Do **NOT** overload the machine. Weigh the laundry the first few times you use the appliance.

The average weights of the most common items are listed below as a guide:

1000g = 1 kg

| | |
|----------------------|-------------|
| Sheet | 700-1000 g |
| Pillow case | 100-200 g |
| Tablecloth | 400-500 g |
| Serviette | 50-100 g |
| Tea towel | 70-120 g |
| Linen hand towel | 100-150 g |
| Towelling hand towel | 150-250 g |
| Towelling bath towel | 700-1000 g |
| Bath robe | 1000-1500 g |
| Man's shirt | 200-300 g |
| Apron | 150-200 g |

- Load the laundry loosely alternating large items with small ones.
- Sort the laundry according to the type of fabric, colour-fastness and how dirty it is.
- Avoid washing unhemmed or torn items as they may unravel.
- Before washing, empty all pockets of small objects which may have been left inside (coins, keys, screws etc) as these could damage the drain pump.
- When washing curtains, remove the hooks.
- Close poppers and zips and fasten loose buttons.
- It is essential to wash new coloured items separately when washing for the first time.
- When washing fabrics requiring different wash temperatures together, always select the lowest temperature.
- White items should not be washed with coloured items.
- Very small items (handkerchiefs, ribbons, socks etc) should be washed in a washing bag or a pillow case.
- Use a good quality detergent suitable for automatic washing machines.
- Use the correct quantities of detergent.
- For wool, use gentle detergent only in small quantities.
- Bleach is very corrosive; it should be used with care and kept out of reach of children.
- Some stains such as fruit, wine, grass, rust etc. are difficult to remove and should be treated before washing with specific products, which can be found in most household shops. In some cases it may help to soak the stain before washing with a special pre-soak product or biological detergent.
- Only wool marked "Pure New Wool - washable, preshrunk" can be washed in the the wool programme; other types of wool should be washed by hands.
- If you have used the machine to wash, rinse or spin only non-colour fast garments, there may be dye left in the sump. To ensure any subsequent wash is not contaminated with the dye, select and carry out a rinse and spin programme, without any garments, to ensure that any dye is removed from the sump.
- Once you have finished using the machine, you are advised to unplug it and turn off the water tap.

Which detergent?....

To ensure you obtain the best wash results from your appliance, it is important to use the right detergent in your everyday wash, and only detergents recommended for use in automatic machines.

To maintain the appearance of your clothes and household textiles and to make them last longer you should use different types of detergent for different washes, whether for whites, colours or delicates.

WHITES

We recommend the Ariel product range which is biological and designed to provide excellent cleaning and stain removal even at low temperatures.



NON BIOLOGICAL

If you prefer to use a non biological detergent, which does not contain enzymes we recommend Fairy. Fairy provides good cleaning and stain removal.



COLOURED

For coloured items you should use a detergent which is designed to clean while maintaining the original colour. Ariel Color does not contain bleach and therefore helps to preserve colours.



DELICATE ITEMS

When washing delicates such as woollens, you should use a product which is specially designed to care for fine fabrics.

Dreft Automatic is suitable for woollens and other delicates.



LAUNDRY BLEACH

For additional stain removal you may wish to use a product such as Ace Gentle Bleach which is used in addition to your chosen detergent. Ace is suitable for all washable fabrics including silks, woollens and coloureds.



And in which form?

Not only are there different types of detergent, but they are also available in different forms. Whether you chose a powder or liquid in traditional or compact form is your own personal choice.

TRADITIONAL POWDERS

Pour the powder directly into the dispenser drawer. Do not sprinkle powder onto clothes in the machine drum.

TRADITIONAL LIQUIDS

Liquid can be placed in the main wash compartment of the detergent drawer marked with the symbol , start the machine immediately upon placing the detergent in the dispenser drawer.

Alternatively the detergent is measured into the specially designed dosing device* which should be placed on top of the laundry, and at the back of the machine drum.

COMPACT POWDERS AND LIQUIDS

Compact detergents (or concentrates as they are also known) are available in liquid or powder form, and generally require a smaller dosage. Follow the manufacturer's instructions to ensure the most economical usage. Pour the detergent directly into the dispenser drawer, or alternatively measure the detergent into the specially designed dosing device* which should be placed on top of the laundry, and at the back of the machine drum.

* **If you use a dosing device in a washer dryer, please ensure the dosing device/ball is removed before carrying out a drying programme.**

FABRIC CONDITIONERS

These are ideal for improving 'softness', and also reduce static cling on synthetics and make ironing easier. They are available in two types:

For example Lenor liquid fabric softener, for use in the **washing machine/washer dryer**.

The liquid fabric softener should be poured into the compartment marked with the symbol .

Follow the manufacturer's dosage instructions and never exceed the MAX level.

















Bounce conditioning sheets for use in a **tumble dryer**. We recommend the conditioning sheets are pinned (using a safety pin) to an article of laundry and placed in the tumble dryer.



Wash Care Symbols

Wash care labels inside garments recommend how to launder your clothes with the best results. The care labelling code is in line with care labelling used in the rest of Europe. The symbols used make it easy to select the correct programme on your washing machine.

| WASHING SYMBOL | WASH ACTION | FABRIC |
|---|--|--|
|  | Normal (Maximum) | White Cotton or Linen without Special Finishes |
|  | Normal (Maximum) | Cotton, Linen or Viscose without Special Finishes Colourfast at 60°C. |
|  | Reduced (Medium) | Nylon, Polyester/Cotton, Viscose with Special Finishes, Cotton/Acrylic Mix. |
|  | Normal (Maximum) | Cotton, Linen or Viscose Colourfast at 40°C but not 60°C. |
|  | Reduced (Medium) | Acrylics, Acetate, Triacetate, Wool mixes, Polyester/wool blends. |
|  | Much Reduced (Minimum) | Wool, wool mixtures, Silks |
|  | Hand wash only | Do not machine wash |
| BLEACHING | | |
|  | Chlorine bleach may be used | |
| IRONING | | |
|  | Hot iron | Cotton, Linen, Viscose |
|  | Warm iron | Polyester mixtures, Wool |
|  | Cool iron | Acrylic, Nylon, Polyester |
| DRY CLEANING | | |
|  | May be dry cleaned. Other letters and/or a bar beneath the circle will indicate the required process to the dry cleaner. | |
| TUMBLE DRYING | | |
|  | with high heat setting | |
|  | with low heat setting | |
|  | May be tumble dried | |
| X | A cross through any symbol means «DO NOT» | |

Important Notes

For best results, always use the dispenser drawer for dispensing detergents and liquid additives. Once the dispenser has been filled, close it by pushing it in gently. This is particularly important if you are using

fabric conditioner to avoid the conditioner entering the machine prematurely.

When using liquid detergent and a prewash programme, place the detergent into the correct compartment in the dispenser drawer, after the prewash has finished.

Washing programmes

Programme for cotton, linen and synthetics

| Programme dial position | Type of laundry | Description | Possible options | Max. load | Progr. time mins. |
|-------------------------|---|---|---|-----------|--------------------------------------|
| White Cottons | White cotton, for example: sheets, household linen, underwear, towels. | Wash at 30°-90°C 3 rinses Long spin | PREWASH EXTRA QUICK SUPER RINSE EASY IRON SPIN/☪ | 6 kg | ZWF 1240W ZWF 1440W 140 |
| | | | | | ZWF 1640W ZWF 1640S 143 |
| Coloured-Cottons | Coloured cotton, for example: shirts, blouses, underwear, towels, house-hold linen. | Wash at 30°-60°C 3 rinses Long spin | PREWASH EXTRA QUICK SUPER RINSE EASY IRON SPIN/☪ | 6 kg | ZWF 1240W ZWF 1440W 119 |
| | | | | | ZWF 1640W ZWF 1640S 122 |
| E-Cottons* | Economy wash for whites or fast coloured cotton or linen fabrics, normally soiled, shirts, underwear, towels. | Wash at 40°-50°-60°C 3 rinses 2 rinses on ZWF 1640S - W) Long spin | PREWASH SUPER RINSE EASY IRON SPIN/☪ | 6 kg | ZWF 1240W ZWF 1440W 133 |
| | | | | | ZWF 1640W ZWF 1640S 99 |
| 40° AA** | Coloured cotton or linen fabrics, normally soiled, shirts, blouses, underwear. | Wash at 40 °C 3 rinses 2 rinses on ZWF 1640S - W) Long spin | PREWASH SUPER RINSE EASY IRON SPIN/☪ | 6 kg | ZWF 1240W ZWF 1440W 139 |
| | | | | | ZWF 1640W ZWF 1640S 135 |
| Synthetics | Synthetic or mixed fabrics, underwear, coloured garments, non-shrink shirts, blouses. | Wash at 30°-60°C 3 rinses Short spin | PREWASH EXTRA QUICK SUPER RINSE EASY IRON SPIN/☪ | 3 kg | ZWF 1240W ZWF 1440W 87 |
| | | | | | ZWF 1640W ZWF 1640S 90 |
| E-Synthetics | Economy wash for synthetic or mixed fabrics, normally soiled. | Wash at 40°C 3 rinses Short spin | PREWASH SUPER RINSE EASY IRON SPIN/☪ | 3 kg | ZWF 1240W ZWF 1440W 87 |
| | | | | | ZWF 1640W ZWF 1640S 90 |



The programme times are intended as a guide only. The actual time will vary depending on incoming water temperature and pressure.

* In compliance with EC directive 92/75 the consumption figures indicated on the Energy label refer to this programme E -Cottons at 60°C.

** Fabrics washed with this programme have a washing efficiency result of AA.

Washing programmes

Programme for delicates, handwash , wool , silk  and Mini 30'. Special programmes.

| Programme dial position | Type of laundry | Description | Possible options | Max. load | Progr. time mins. |
|---|---|--|---|-----------|-------------------------------------|
| Delicates | Delicate fabrics, for example acrylics, polyester mixtures. | Wash at 30°-40°C 3 rinses Short spin | PREWASH EXTRA QUICK SUPER RINSE SPIN/☐ | 3 kg | ZWF 1240W ZWF 1440W 58 |
| | | | | | ZWF 1640W-S 58 |
| Handwash  | Delicate fabrics, for example curtains, silks to be hand washed. | Wash at 30°-40°C 3 rinses Short spin | SPIN/☐ | 2 kg | ZWF 1240W ZWF 1440W 57 |
| | | | | | ZWF 1640W-S 57 |
| Wool  | Specially tested programme for wool garments bearing the “Pure new wool, non-shrink, machine washable” label. | Wash at 30°-40°C 3 rinses Short spin | SPIN/☐ | 2 kg | ZWF 1240W ZWF 1440W 57 |
| | | | | | ZWF 1640W-S 57 |
| Silk  | Silk fabrics. | Wash at 30 °C 3 rinses Short spin | SUPER RINSE SPIN/☐ | 1 kg | ZWF 1240W ZWF 1440W 39 |
| | | | | | ZWF 1640W-S 39 |
| Mini 30' | Special programme for extremely delicate items. | Wash at 30 °C 2 rinses Short spin | SPIN/☐ | 3 kg | ZWF 1240W ZWF 1440W 30 |
| | | | | | ZWF 1640W-S 31 |
| Rinse | Separate rinse cycle for hand washed cotton or linen items . | 3 rinses with liquid additive, if required. Long spin at max. speed. | SUPER RINSE EASY IRON SPIN/☐ | 6 kg | ZWF 1240W ZWF 1440W 45 |
| | | | | | ZWF 1640W-S 48 |
| Drain | For emptying out the last rinse water in programmes with the Rinse Hold ☐ option. | Draining of water | | - | ZWF 1240W ZWF 1440W 2 |
| | | | | | ZWF 1640W-S 2 |
| Spin | Separate spin for cottons. | Drain and spin at max. speed | SPIN | 6 kg | ZWF 1240W ZWF 1440W 10 |
| | | | | | ZWF 1640W-S 13 |
| Delicate Spin | Separate spin for all fabric. | Short spin | SPIN (only ZWF 1240 W) | 6 kg | ZWF 1240W ZWF 1440W 6 |
| | | | | | ZWF 1640W-S 6 |
| O Reset/off | For cancelling the wash programme which is running and for switching the machine off. | | | | |

Maintenance and Cleaning

Before any maintenance or cleaning is carried out you must **DISCONNECT** the appliance from the electricity supply.

Descaling

The water we use normally contains lime. It is a good idea to periodically use a water softening powder in the machine. Do this separately from any laundry washing, and according to the softening powder manufacturer's instructions. This will help to prevent the formation of lime deposits.

After each wash

Leave the door open for a while. This helps to prevent mould and stagnant smells forming inside the appliance. Keeping the door open after a wash will also help to preserve the door seal.

Maintenance Wash

With the use of low temperature washes it is possible to get a build up of residues inside the drum.

We recommend that a maintenance wash be performed on a regular basis.

To run a maintenance wash:

- The drum should be empty of laundry.
- Select the hottest cotton wash programme.
- Use a normal measure of detergent, must be a powder (such as Ariel Futur).

External cleaning

Clean the exterior cabinet of the appliance with mild washing up liquid and water only, and then dry thoroughly.

Cleaning the dispenser drawer

The washing powder and additive dispenser drawer should be cleaned regularly.

Remove the drawer by pressing the catch downwards and by pulling it out. Flush it out under a tap, to remove any traces of accumulated powder.

To aid cleaning, the top part of the additive compartment should be removed.

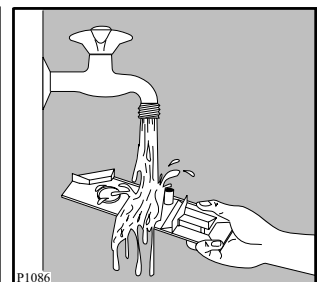
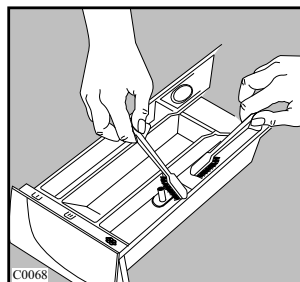
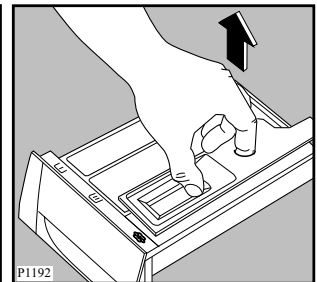
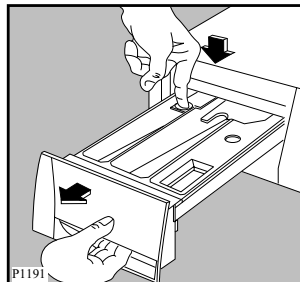

Cleaning the drawer recess

Having removed the drawer, use a small brush to clean the recess, ensuring that all washing powder residue is removed from the upper and lower part of the recess.

Replace the drawer and run the rinse programme without any clothes in the drum.

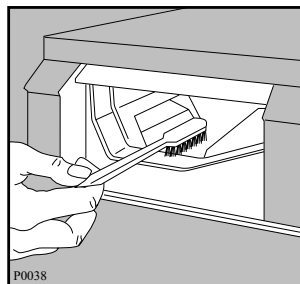

Cleaning the pump

The pump should be inspected if

- the machine does not empty and/or spin
- the machine makes an unusual noise during draining due to objects such as safety pins, coins etc. blocking the pump.

Proceed as follows:

- Disconnect the appliance.
- If necessary wait until the water has cooled down.
- Open the pump door.

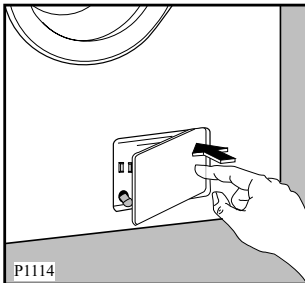

- Place a container close to the pump to collect any spillage.
- Pull out the emergency emptying hose, place it in the container and remove its cap.
- When no more water comes out, unscrew the pump cover and remove it. Always keep a rag nearby to dry up spillage of water when removing the cover.

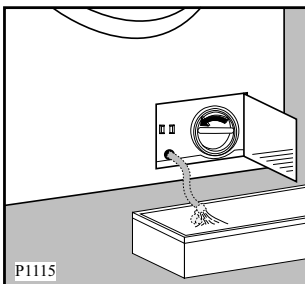

- Remove any objects from the pump impeller by rotating it.

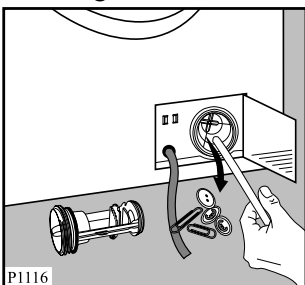

- Put the cap back on the emergency emptying hose and place the latter back in its seat.

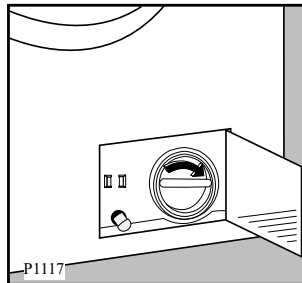

- Screw the pump cover fully in.
- Close the pump door.

Warning

When the appliance is in use and depending on the programme selected there can be hot water in the pump. Never remove the pump cover during a wash cycle, always wait until the appliance has finished the cycle, and is empty. When replacing the cover, ensure it is securely retightened so as to stop leaks and young children being able to remove it.

Cleaning the water inlet filter

If your water is very hard or contains traces of lime deposit, the water inlet filter may become clogged.

It is therefore a good idea to clean it from time to time.

Turn off the water tap. Unscrew the water inlet hose.

Clean the filter using a hard bristle brush.

Tighten up the inlet hose.

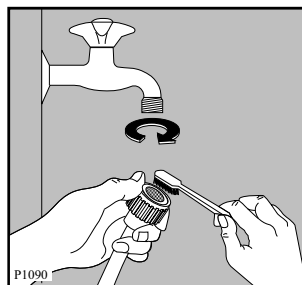

The dangers of freezing

If the machine is installed in a place where the temperature could drop below 0°C, proceed as follows:

- Remove the plug from the socket.
- Close the water tap and unscrew the water inlet hose from the tap.
- Place the end of the emergency emptying hose and that of the inlet hose in a bowl placed on the floor and let water drain out.
- Screw the water inlet hose back on and reposition the emergency emptying hose after having put the cap on again.

By doing this, any water remaining in the machine is removed, avoiding the formation of ice and, consequently, breakage of the affected parts. When you use the machine again, make sure that the ambient temperature is above 0°C.

Emergency emptying out

If the water is not discharged, proceed as follows to empty out the machine:

- pull out the plug from the power socket;
- close the water tap;
- if necessary, wait until the water has cooled down;
- open the pump door;
- place a bowl on the floor and place the end of the emergency emptying hose into the bowl. Remove its cap. The water should drain by gravity into the bowl. When the bowl is full, put the cap back on the hose. Empty the bowl. Repeat the procedure until water stops flowing out;
- clean the pump if necessary as previously described;
- replace the emergency emptying hose in its seat after having plugged it;
- screw the pump cover again and close the door.

Something Not Working

Certain problems are due to lack of simple maintenance or oversights, which can be solved easily without calling out an engineer. Before contacting your local Service Force Centre, please carry out the checks listed below.

IMPORTANT: if you call out an engineer to a fault listed below, or to repair a fault caused by incorrect use or installation, a charge will be made even if the appliance is under guarantee.

During machine operation it is possible that one of the following alarm codes appears on the display and the “End” light starts to flash:

- **E10**: problem with the water supply
- **E20**: problem with water draining
- **E40**: door open

Once the problem has been eliminated, press the START/PAUSE button to restart the programme. If after all checks, the problem persists, contact your local Service Force Centre.

| Symptom | Possible causes |
|---|---|
| The machine does not start | <ul style="list-style-type: none"> ● The door has not been closed. (E40) ● The plug is not properly inserted in the power socket. ● There is no supply at the socket. ● The main fuse or the fuse in the plug has blown. ● The START/PAUSE button has not been depressed. ● The DELAY START has been selected. |
| The machine does not fill | <ul style="list-style-type: none"> ● The water tap is closed. (E10) ● The filter in the inlet hose is blocked. (E10) ● The inlet hose may be squashed or kinked. (E10) ● The door has not been closed. (E40) |
| The machine fills then empties immediately | <ul style="list-style-type: none"> ● The end of the drain hose is too low. ● The end of the drain hose is submerged in water. ● There is no vent in the end of the drain hose. |
| The machine does not empty and/or does not spin | <ul style="list-style-type: none"> ● The drain hose may be squashed or kinked. (E20) ● The option  has been selected. ● The drain pump may be blocked. (E20) ● The drain hose extension, if fitted, is not correct. Follow the instructions for connecting to the waste. ● The drainage system pipes are blocked. ● The wash load is unbalanced: redistribute the clothes inside the drum to allow the machine to spin. |
| There is water on the floor | <ul style="list-style-type: none"> ● Too much detergent or unsuitable detergent has been used (creates too much foam). ● Check whether there are any leaks from the inlet hose fittings. It is not always easy to see this as the water runs down the hose; check to see if it is damp. ● The drain hose may be damaged or not securely positioned. ● The detergent dispenser drawer or recess is clogged. ● The drainage system pipes are blocked. ● The cap on the emergency emptying hose has not been replaced after cleaning the pump. |
| Unsatisfactory washing results | <ul style="list-style-type: none"> ● Too little detergent or unsuitable detergent has been used. An insufficient amount of detergent leaves the laundry looking grey and causes lime scale to form. ● Stubborn stains have not been treated prior to washing ● The correct wash programme/temperature has not been selected. ● Too much laundry has been placed in the drum. |

| Symptom | Possible causes |
|--|---|
| The machine vibrates when spinning | <ul style="list-style-type: none"> • The internal packing has not been removed. • The machine is in contact with the wall or furniture. • The machine is not level and stable (check diagonally). • The washing load is badly distributed in the drum. • Maybe there is very little laundry in the drum. |
| The door will not open | <ul style="list-style-type: none"> • The water level is above the bottom edge of the door. • The machine is heating the water. • The drum is turning. |
| Spinning starts late or the machine does not spin | <ul style="list-style-type: none"> • The electronic unbalance detection device has cut in because the laundry is not evenly distributed in the drum. The laundry is redistributed by reverse rotation of the drum. This may happen several times before the unbalance disappears and normal spinning can resume. If, after 10 minutes, the laundry is still not evenly distributed in the drum, the machine will not spin. In this case, redistribute the load manually and select the spin programme. |
| No water is visible in the drum | <ul style="list-style-type: none"> • Machines based on modern technology operate very economically using very little water without affecting performance. |

Service & Spare Parts **SERVICE FORCE**

In the event of your appliance requiring service, or if you wish to purchase spare parts, please contact your local Service Force Centre by telephoning:

0870 5 929929

Your telephone call will be automatically routed to the Service Force Centre covering your post code area.

For the address of your local Service Force Centre and further information about Service Force, please visit the website at www.serviceforce.co.uk.

For Customer Service in Ireland please contact us at the address below:

Zanussi Electrolux
Electrolux Group (Irl) Ltd
Long Mile Road
Dublin 12
Republic of Ireland

Tel: +353 (0)1 4090751

Email: service.eid@electrolux.ie

Before calling out an engineer, please ensure you have read the details under the heading "Something Not Working".

When you contact the Service Force Centre you will need to give the following details:

1. Your name, address and post code
2. Your telephone number
3. Clear and concise details of fault
4. The model and serial number of the appliance (found on the rating plate - see picture)
5. The purchase date.

Please note that a valid purchase receipt or guarantee documentation is required for in-guarantee service calls.

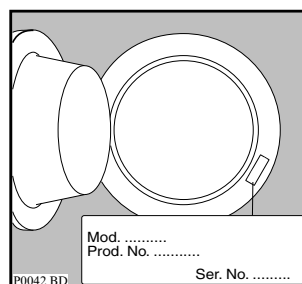

Customer Care Department

For general enquiries concerning your Zanussi Electrolux appliance or for further information on Zanussi Electrolux products, please contact our Customer Care Department by letter or telephone at the address below or visit our website at www.zanussi.co.uk

Customer Care Department
Zanussi Electrolux
55-77 High Street
Slough
Berkshire
SL1 1DZ
Tel 08705 727727*

* calls to this number may be recorded for training purposes.

Guarantee Conditions

Standard guarantee conditions

We, Zanussi Electrolux, undertake that if, within 12 months of the date of the purchase, this ZANUSSI ELECTROLUX appliance or any part thereof is proved to be defective by reason only of faulty workmanship or materials, we will, at our option repair or replace the same FREE OF ANY CHARGE for labour, materials or carriage on condition that:

- The appliance has been correctly installed and used only on the electricity supply stated on the rating plate.
- The appliance has been used for normal domestic purposes only, and in accordance with the manufacturer's instructions.
- The appliance has not been serviced, maintained, repaired, taken apart or tampered with, by any person not authorised by us.
- All service work under this guarantee must be undertaken by a Service Force Centre.
- Any appliance or defective part replaced shall become the Company's property.
- This guarantee is in addition to your statutory and other legal rights.

Home visits are made between **8.30am** and **5.30pm** Monday to Friday. Visits may be available outside these hours in which case a **premium** will be charged.

Exclusions

This guarantee does not cover:

- Damage or calls resulting from transportation, improper use or neglect, the replacement of any light bulbs or removable parts of glass or plastic.
- Costs incurred for calls to put right an appliance which is improperly installed or calls to appliances outside the United Kingdom.
- Appliances found to be in use within a commercial environment, plus those which are subject to rental agreements.
- Products of Zanussi Electrolux manufacture which are NOT marketed by Zanussi Electrolux.

European guarantee





If you should move to another country within Europe then your guarantee moves with you to your new home subject to the following qualifications:

- The guarantee starts from the date you first purchased your product.
- The guarantee is for the same period and to the same extent for labour and parts as exists in the new country of use for this brand or range of products.
- The guarantee relates to you and cannot be transferred to another user.
- Your new home is within the European Community (EC) or European Free Trade Area.
- The product is installed and used in accordance with our instructions and is only used domestically, i.e. a normal household.
- The product is installed taking into account regulations in your new country.

Before you move please contact your nearest Customer Care Centre, listed below, to give them details of your new home. They will then ensure that the local Service Organisation is aware of your move and able to look after you and your appliances.

| | | |
|---------|-----------|----------------------|
| France | Senlis | +33 (0) 344 62 29 29 |
| Germany | Nurnberg | +49 (0) 800 234 7378 |
| Italy | Pordenone | +39 0434 39 4700 |
| Sweden | Stockholm | +46 (0) 8 672 53 90 |
| UK | Slough | +44 (0) 1753 219897 |
| Ireland | Dublin | +44 (0)1 4090751 |

Installation Instructions

-  It is dangerous to alter the specifications or attempt to modify this product in any way.
-  Care must be taken to ensure that the appliance does not stand on the electrical supply cable.
-  Any electrical work required to install this appliance should be carried out by a qualified electrician or competent person.
-  Any plumbing work required to install this appliance should be carried out by a qualified plumber or competent person.

Technical Specifications

| | | |
|--|--|--|
| DIMENSIONS | Height Width Depth | 85 cm 60 cm 63 cm |
| POWER SUPPLY VOLTAGE TOTAL POWER ABSORBED | | 230-240 V/50 Hz 2050 W (10A) |
| WATER PRESSURE | Minimum Maximum | 50 kPa (0.5 bar) 800 kPa (8 bar) |
| MAXIMUM RECOMMENDED LOAD | Cotton, linen Synthetics Delicate fabrics Wool and handwash Silk | 6 kg 3 kg 3 kg 2 kg 1 kg |
| SPIN SPEED | Maximum | 1200 rpm (ZWF 1240 W) 1400 rpm (ZWF 1440 W) 1600 rpm (ZWF 1640 W-S) |
| CONSUMPTION DATA FOR WASHING 6 KG COTTONS WITH "E-COTTONS" AT 60°C | Energy Water Time | ZWF 1240-1440 W ZWF 1640 W-S) 1.02 kWh 1.02 kWh 49 litres 49 litres 130 minutes 99 minutes |

-  This appliance complies with the following E.E.C. Directives:
- 73/23 EEC of 19.2.73 (Low Voltage Directive) and subsequent modifications;
 - 89/336 EEC of 3.5.89 (Electromagnetic Compatibility Directive) and subsequent modifications.

Unpacking

 All transit bolts and packing must be removed before using the appliance.

You are advised to keep all the packaging for re-use in case the machine is to be transported again.

Using a spanner unscrew and remove the two rear bottom screws. Slide out the two plastic pins.

Lay the machine gently on its back, making sure that the hoses are not squashed.

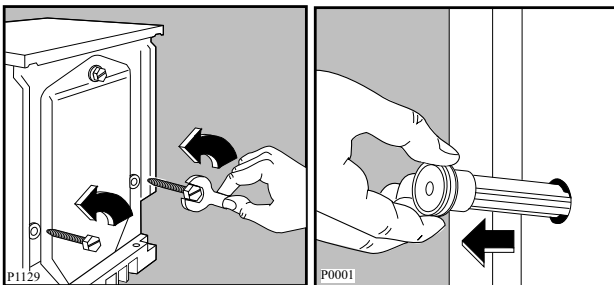

Remove the polystyrene block from the bottom of the machine and release the two plastic bags.

Very carefully slide out the left polythene bag, removing it towards the right and then downwards.

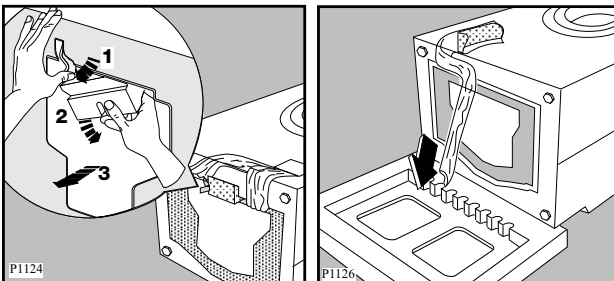

Repeat the operation for the right polythene bag, removing it towards the left and then upwards.

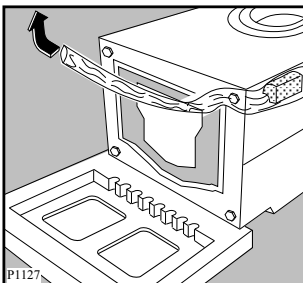

Remove the polystyrene base.

Set the machine upright and unscrew the remaining rear screw. Slide out the relevant pin.

Fill all the holes with the plastic plugs supplied with the instruction booklet.

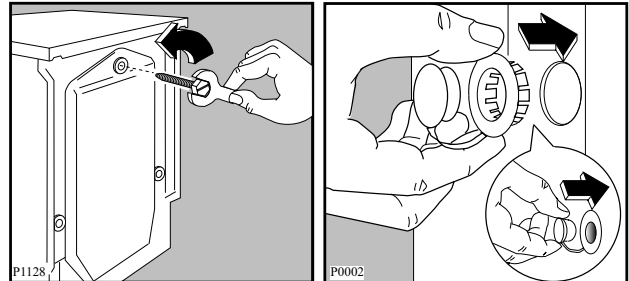

Positioning

Install the machine on a flat hard floor.

Make sure that air circulation around the machine is not impeded by carpets, rugs etc. Check that the machine does not touch the wall or other kitchen units.

Never place cardboard, wood or similar materials under the machine to compensate for any unevenness in the floor.

Your new washing machine has been designed to be permanently plumbed in to your home's water supply and drainage system. However, if this is not possible, it may be connected to a suitable existing tap with the drain hose discharging into a sink.

The appliance has an inlet hose, with female 3/4" BSP thread connector. If this connection is not compatible with the plumbing of the existing installation, a variety of connectors are available from good hardware stores and plumbers merchants to suit most domestic plumbing. Any alteration to your existing plumbing must be carried out by a competent person, or qualified plumber.

Installation on a Suspended Floor

Suspended wooden floors are particularly susceptible to vibration. To help prevent vibration we recommend you place a waterproof wood panel, at least 15 mm thick under the appliance, secured to at least 2 floor beams with screws. If possible install the appliance in one of the corners of the room, where the floor is more stable.

Water inlet

Connect the hose to a tap with a 3/4" thread. Always use the hose supplied with the appliance to connect to the water supply.

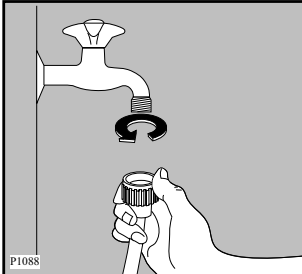

Installation should comply with local water authority and building regulations' requirements.

The appliance must be connected to a cold water supply.

A minimum water pressure of 50 kPa (0.5 bar) is required for safe operation of the appliance.

If you cannot make the cold water connection direct from the rising mains, you may be able to operate the appliance from your cold water storage system.

There should be a minimum distance of 5.02m (16.5 ft) between the appliance's inlet and the bottom of the water storage tank.

Set the hose correctly by loosening the ring nut. After positioning the inlet hose, be sure to tighten the ring nut again to prevent leaks.

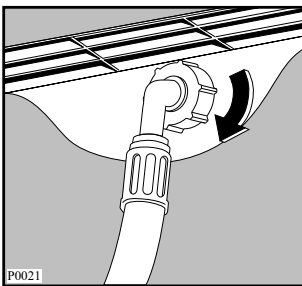

Water drainage

This appliance is designed to be permanently plumbed into your home's drainage system using one of the following methods.

1. Into a drainage standpipe.

Firstly form a hook in the end of the drain hose using the "U" piece" supplied.

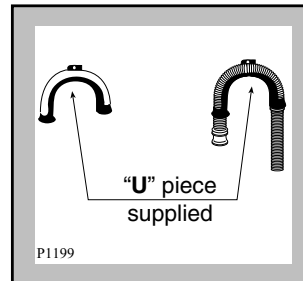

Place the drain hose into your standpipe, which should have an internal diameter of approximately 38mm thus ensuring there is an air break between the drain hose and standpipe.

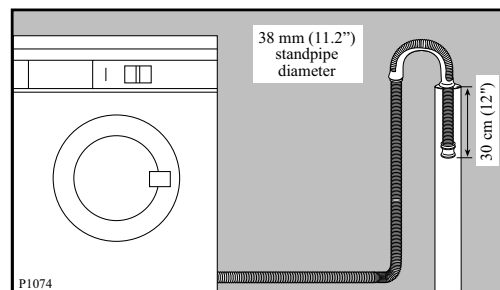

When discharging into a standpipe ensure that the top of the standpipe is no more than 90cm (35.4") and no less than 60cm (23.6") above floor level.

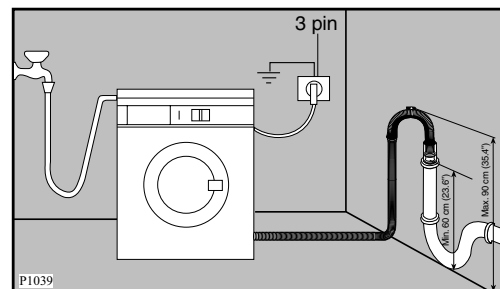

The drain hose may be extended to a maximum of 4 metres. An additional drain hose and joining piece is available from your local Service Force Centre. The joining piece must have an internal diameter of 18mm.

If your drain hose looks like this (see below) you do not require the “U” piece”. Just push the hose firmly into the standpipe.

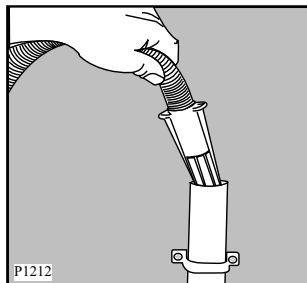

2. Onto a sink outlet spigot.

If the outlet spigot has not been used before, remove any blanking plug that may be in place.

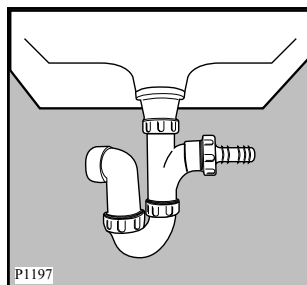

Push the drain hose onto the spigot and secure with a clip if required, ensure a loop is formed in the drain hose (see diagram) to prevent waste from the sink entering the washing machine.

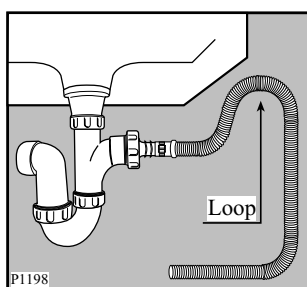

The drain hose may be extended to a maximum of 4 metres. An additional drain hose and joining piece is available from your local Service Force Centre. The joining piece must have an internal diameter of 18mm.

Important

Before connecting the machine to new pipework or to pipework that has not been used for some time, run off a reasonable amount of water to flush out any debris that may have collected in the pipes.

Levelling

Level the washing machine by raising or lowering the feet. The feet may be tight to adjust as they incorporate a self locking nut, but the machine **MUST** be level and stable (check diagonally).

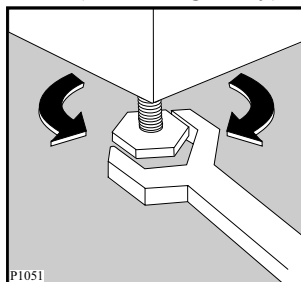

Any necessary adjustment can be made with a spanner. Accurate levelling prevents vibration, noise and displacement of the machine during operation.

Some vibration is inevitable, especially if mounted on a wooden floor.

Sprung wooden floors are particularly susceptible to vibration. For advice, consult a builder. If possible, always place the machine on a solid floor.

Special conditions

If the floor is carpeted or covered with crumbly or soft material, insert a rigid support base under the feet to prevent noise, vibration or displacement. The base should protrude a few centimetres beyond the edges of the machine.



Warning

The machine should **NOT** be placed on deep pile carpeting.

Note

Please ensure that when the appliance is installed it is easily accessible for the engineer in the event of a breakdown.

In the interest of the environment

Washing machines and dishwashers should be connected to the FOUL drainage system, the water will then be taken to a sewage works for treatment before being discharged safely into a river.

It is essential that these appliances are not connected to the surface water drainage system as this water is discharged directly into a river or stream and may cause pollution.

If you require any further advice please contact your local water authority.

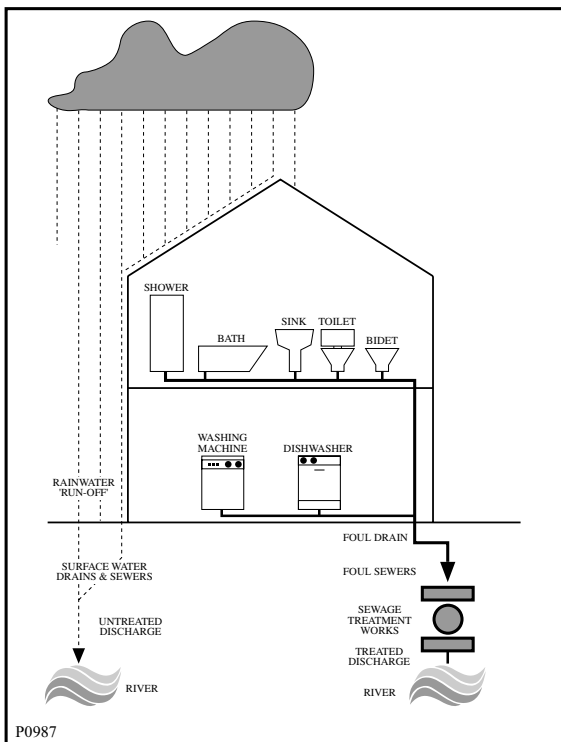

Electrical connection

Any electrical work required to install this appliance should be carried out by a qualified electrician or competent person.



WARNING: THIS APPLIANCE MUST BE EARTHED.

The manufacturer declines any liability should this safety measure not be observed.

Before switching on, make sure the electricity supply voltage is the same as that indicated on the appliance's rating plate. The rating plate is located at the top of the rim of the open door.

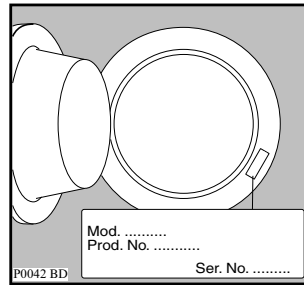

The appliance is supplied with a 13amp plug fitted. In the event of having to change the fuse in the plug supplied, a 13amp ASTA approved (BS1363/A) fuse must be used.

Should the plug need to be replaced for any reason, proceed as described below.

The wires in the mains lead are coloured in accordance with the following code:

- Green and Yellow - Earth
- Blue - Neutral
- Brown - Live

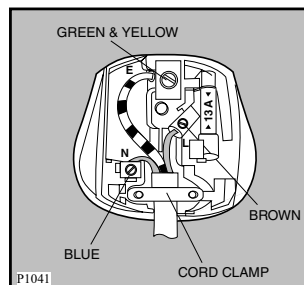

The wire coloured green and yellow must be connected to the terminal marked with the letter «E» or by the earth symbol \perp or coloured green and yellow.

The wire coloured blue must be connected to the terminal marked «N» or coloured black.

The wire coloured brown must be connected to the terminal marked «L» or coloured red.

Upon completion there must be no cut, or stray strands of wire present and the cord clamp must be secure over the outer sheath.



WARNING:

A cut off plug inserted into a 13 amp socket is a serious safety (shock) hazard.

Ensure that the cut off plug is disposed of safely.

The power supply cable must be easily accessible after installing the appliance.

Permanent connection

In the case of permanent connection it is necessary that you install a double pole switch between the appliance and the electricity supply (mains), with a minimum gap of 3mm between the switch contacts and of a type suitable for the required load in compliance with the current electrical regulations.

The switch must not break the yellow and green earth cable at any point.

 **From the Electrolux Group. The world's No. 1 choice.**

The Electrolux Group is the world's largest producer of powered appliances for kitchen, cleaning and outdoor use. More than 55 million Electrolux Group products (such as refrigerators, cookers, washing machines, vacuum cleaners, chain saws and lawn mowers) are sold each year to a value of approx. USD 14 billion in more than 150 countries around the world.