

# ZANUSSI

 Electrolux

## WASHING MACHINE

### ZWF 1011 W

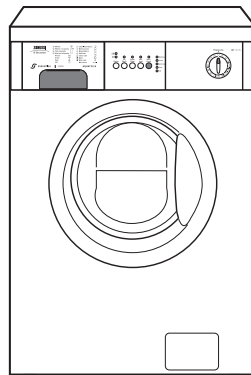



# Important Safety Information

It is most important that this instruction book should be retained with the appliance for future reference. Should the appliance be sold or transferred to another owner, or should you move house and leave the appliance, always ensure that the book is supplied with the appliance in order that the new owner can get to know the functioning of the appliance and the relevant warnings.

These warnings have been provided in the interest of safety. You **MUST** read them carefully before installing or using the appliance.

## Installation

- This appliance is heavy. Care should be taken when moving it.
- It is dangerous to alter the specifications or attempt to modify this product in any way.
- All packing and transit bolts must be removed before use. Serious damage can occur to the product and to property if this is not adhered to. See relevant section in instructions.
- Any plumbing work required to install this appliance should be carried out by a qualified plumber or competent person.
- Any electrical work required to install this appliance should be carried out by a qualified electrician or competent person.
- Care must be taken to ensure that the appliance does not stand on the electrical supply cable.
- If the machine is situated on a carpeted floor, please adjust the feet in order to allow air to circulate freely.

## Child Safety

- This appliance is designed to be operated by adults. Children should not be allowed to tamper with the controls or play with the product.
- Pets and children have been known to climb into washing machines. Please check your drum before use.
- The glass door becomes very hot during the washing cycle. Keep children away from the vicinity of the appliance whilst it is in operation.
- Keep all packaging well away from children.
- Keep all detergents in a safe place out of children's reach.

## Use

- Always unplug the appliance and turn off the water supply after use.
- Do not overload the appliance. See relevant section in the instruction book.

- Always look through the glass door to check if water has drained before opening the door.
- The user should always check that they have not left their gas lighter (disposable or otherwise) in their clothing.
- Only wash fabrics which are designed to be machine washed. If in doubt, consult the care label on the clothes.
- Before washing, ensure that all pockets are empty and buttons and zips are fastened. Avoid washing frayed or torn articles and treat stains such as paint, ink, rust, and grass before washing. Underwired bras must NOT be machine washed.
- Any objects such as coins, safety pins, nails, screws, stones or any other hard, sharp material can cause extensive damage and must not be placed into the machine.
- Garments which have been in contact with volatile petroleum products should not be machine washed. If volatile cleaning fluids are used, care should be taken to ensure that the fluid is removed from the garment before placing in the machine.
- Wash small items such as socks, laces, washable belts etc in a washing bag or pillow case as it is possible for such items to slip down between the tub and the inner drum.
- Only use the advised quantities of fabric softener. Damage to the fabric can ensue if you over-fill. Refer to the manufacturer's recommendations of quantities.
- As some duvets and eiderdowns should be washed in large commercial machines because of their bulk, please check with the manufacturer of the item before washing in a domestic machine.
- Leave the porthole door slightly ajar between washes to preserve the door seal.
- Under no circumstances should you attempt to repair the machine yourself. Repairs carried out by inexperienced persons may cause injury or serious malfunctioning. Contact your local Zanussi Electrolux Service Centre. Always insist on genuine Zanussi Electrolux spare parts.

# Contents

<b>For the User</b>			
<b>Important Safety Information</b>	2		
<b>Your New Washing Machine</b>	4		
<b>Description of the Appliance</b>	5		
Door locked light	5		
Detergent dispenser drawer	5		
Child Safety Feature	5		
<b>The Control Panel</b>	6-7		
Programme information	7		
<b>Operating sequence</b>	8-11		
Washing 5 kg of white cotton at 90°C	8		
Load the laundry	8		
Measure out the detergent	8		
Measure out the fabric softener	8		
Select the required programme	8		
Select spin speed reduction or no spin option	8		
Select the required option	8		
Start the programme	9		
Altering a programme	9		
Interrupting a programme	9		
Cancelling a programme	9		
Opening the door after the programme has started	9		
At the end of the programme	9		
Washing 2 kg of mixed fabrics at 50°C	10		
Load the laundry	10		
Measure out the detergent and the fabric softener	10		
Select the required programme	10		
Select spin speed reduction or no spin option	10		
Select the required option(s)	10		
Start the programme	10		
At the end of the programme	11		
<b>Washing Hints</b>	12-13		
Which detergent?....	13		
And in which form?	13		
<b>Wash Care Symbols</b>	14		
<b>Washing Programmes</b>	15-16		
		<b>Maintenance and Cleaning</b>	17-18
		Descaling	17
		After each wash	17
		Maintenance Wash	17
		External cleaning	17
		Cleaning the dispenser drawer	17
		Cleaning the drawer recess	17
		Cleaning the pump	17
		Cleaning the water inlet filter	18
		Emergency emptying out	18
		The dangers of freezing	18
		<b>Something Not Working</b>	19-20
		<b>Service and Spare Parts</b>	20
		<b>Guarantee Conditions</b>	21
		<b>For the Installer</b>	
		<b>Installation Instructions</b>	22
		<b>Technical Specifications</b>	22
		Unpacking	23
		Positioning	23
		Installation on a Suspended Floor	23
		Water inlet	24
		Water drainage	24-25
		Levelling	25
		Special conditions	25
		In the interest of the environment	25
		Electrical connection	26
		Permanent connection	26

## Guide to use the Instruction Book

The following symbols will be found in the text to guide you throughout the instructions:

 **Safety instructions**

 **Hints and tips**

 **Environmental information**



# Your New Washing Machine

Your new washing machine meets all modern requirements for effective treatment of laundry with low water, energy and detergent consumption.

- **The programme selector dial** combines the function of programme and temperature selection, making it easier to set the programme.
- **The programme progress display** shows the washing phase and the end of the programme.
- **The special wool programme** with its new delicate wash system treats your woollens with extreme care.
- **The ECO VALVE** allows total use of detergent and reduces water consumption so saving energy.

## Ecological hints

To save water and energy and help protect the environment, we recommend that you follow these hints:

- Adjust the quantity of detergent according to the hardness of your water supply, the amount of laundry and the degree of soiling.
- A programme without prewash is sufficient for normally soiled laundry.
- The machine works more economically if it is fully loaded.
- With adequate pre-treatment, stains and limited soiling can be removed; the laundry can then be washed at a lower temperature, so saving energy.



## In the interest of the environment

- Materials marked with the symbol  are recyclable.
- Check with your local Council or Environmental Health Office to see if there are facilities in your area for re-cycling this appliance.
- When the appliance is to be scrapped, cut off the power supply cable and make the door lock device unusable to prevent young children from being trapped inside.

The symbol  on the product or on its packaging indicates that this product may not be treated as household waste. Instead it shall be handed over to the applicable collection point for the recycling of electrical and electronic equipment. By ensuring this product is disposed of correctly, you will help prevent potential negative consequences for the environment and human health, which could otherwise be caused by inappropriate waste handling of this product. For more detailed information about recycling of this product, please contact your local city office, your household waste disposal service or the shop where you purchased the product.

**How do we help to protect the environment?  
We use recycled paper!**

## Important



Your machine is fitted with a balance control device, which ensures the machine is stable during the spin. If the wash load appears not to have been spun sufficiently at the end of the wash cycle, because it is not evenly distributed in the drum, the balance control device may have operated. It will therefore be necessary to redistribute the wash load manually and select a spin programme. For more detailed information see the section headed "Something Not Working".

# Description of the Appliance

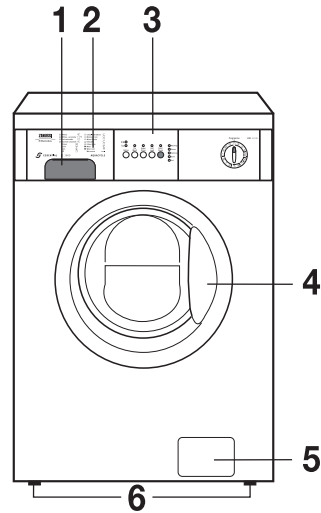
- 1 Detergent dispenser drawer
- 2 Programme guide
- 3 Control panel
- 4 Door opening handle
- 5 Drain pump
- 6 Adjustable feet



## Detergent dispenser drawer

-  Prewash
-  Main wash
-  Fabric softener

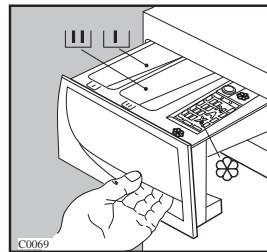

# The Control Panel

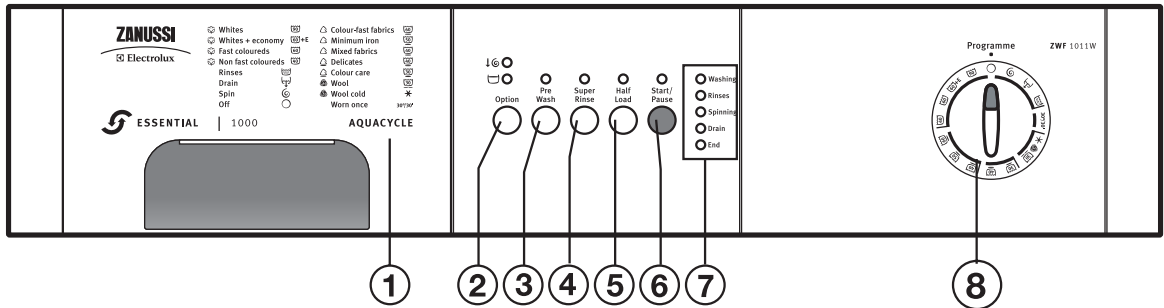

## I Programme guide

### Programme Option buttons

Depending on the programme, different functions can be combined. These must be selected after choosing the desired programme and before depressing the “Start / Pause” button.

When these buttons are pressed, the corresponding pilot lights come on. When they are pressed again, the pilot lights go out.

If an incorrect option is selected, the corresponding pilot light flashes for about 2 seconds.

### 2 ↓⊖ (Spin reduction)/ ⊔ (Rinse hold) button

By depressing this button you can reduce the final and the intermediate spin speeds or select the ⊔ (rinse hold) option:

- ↓⊖ (spin reduction): by selecting this option the speed will be reduced as follows:  
**Cotton:** from 1000 to 500 r.p.m.  
**Synthetics and wool:** from 900 to 450 r.p.m.  
**Delicates:** from 700 to 450 r.p.m.
- ⊔ (rinse hold): by selecting this option the water of the last rinse is not emptied out, to prevent the fabrics from creasing.  
 At the end of the programme the pilot light “End” illuminates. To drain the water, proceed as follows:
  - turn the programme selector dial to position “O”;
  - select programme ⊔ (drain) or ⊖ (spin). In this case reduce the spin speed by means of the relevant button to adapt it to the fabrics to be spun.
  - press “Start / Pause” button.

### 3 Prewash button

Select this option if you wish your laundry to be prewashed before the main wash (**not available for wool**). The prewash ends with a short spin in programmes for cotton and synthetic fabrics, whereas in the programme for delicate fabrics the water is only drained.

### 4 Super Rinse button

Can be used with all programmes, except wool.

The machine will add 2 rinses to the selected programme.

This option is recommended for people who are allergic to detergents and in areas where the water is very soft.

### 5 Half Load button

Select this button to reduce water consumption on the rinse cycle when washing a smaller load of cottons or linens (maximum load size = 2.25 kg).

The machine will perform 2 rinses instead of 3.

### 6 Start / Pause button

After having selected the required programme, press this button to start the machine; the corresponding pilot light stops flashing and illuminates continuously.

To interrupt a programme which is running, depress the “Start / Pause” button: the corresponding pilot light starts to flash.

To restart the programme from the point at which it was interrupted, **press the “Start / Pause” button again.**

### 7 Programme progress display

By selecting the wash programme, the pilot lights corresponding to the various phases making up the programme come on.

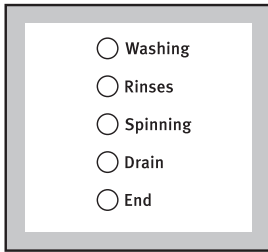

After the machine has started, only the running phase pilot light stays on.

The “**End**” pilot light flashes in the event of operating problems:

- 4 flashes = the door has not been closed
- 2 flashes = the machine does not empty
- 1 flash = the machine does not fill

To eliminate the problem, see paragraph “Something not working”.

The “**End**” pilot light comes on when the programme is finished and indicates that the door can be opened (see page 9).

## 8 Programme selector dial

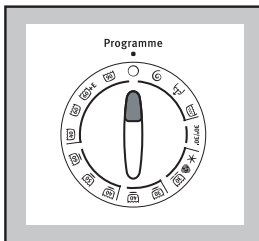

The selector dial can be turned either clockwise or anticlockwise.

Position **O** corresponds to Reset programme / Switching OFF of the machine.

### ATTENTION!

If you turn the programme selector dial to another programme when the machine is working, the lights of the programme progress display start to flash. The machine will not perform the new selected programme.

## Programme information



The wool wash cycles of this machine have been approved by Woolmark for the washing of machine washable Woolmark products provided that the garments are washed according to the instructions on the garment label and those issued by the manufacturer of this washing machine. M9604.



This is a complete programme to be used for lightly soiled laundry or for laundry which needs freshening up (not available for wool).

Max load: 2. kg .

Washing temperature: 30°C

Number of rinses: 2 .

Programme duration: 30 minutes.

Short spin at 700 r.p.m max.



With this programme it is possible to rinse and spin garments which have been washed by hand.

The machine performs 3 rinses, followed by a final short spin at the maximum speed that can be reduced by means of selecting the relevant button.



For emptying out the water of the last rinse in programmes with the  (rinse hold) option.

Turn first the programme selector dial to **O**, then select drain programme and depress the “**Start / Pause**” button.



Separate spin for hand washed garments and after programmes with  (rinse hold) option. Before selecting this programme the selector dial must be turned to “**O**”. You can choose the speed by means of the relevant button in order that to the fabrics are spun at the correct speed.

# **i** Operating Sequence

Before the first wash, we recommend that you pour 2 litres of water into the main wash compartment **[II]** of the detergent drawer in order to activate the ECO valve. Then run a cotton cycle at 90°C, without any laundry in the machine, to remove any manufacturing residue from the drum and tub.

Pour 1/2 a measure of detergent into the dispenser drawer and start the machine.

## WASHING 5 KG OF WHITE COTTON AT 90°C

Suppose you have 5 kg of heavy soiled laundry to wash. It is white cotton and is suitable for high temperature washing.

### 1. Load the laundry

Open the door by carefully pulling on the door handle outwards.

Place the laundry in the drum, one item at a time, shaking them out as much as possible. Close the door.

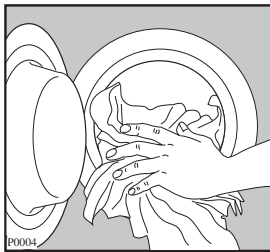

### 2. Measure out the detergent and the fabric softener

Pull out the dispenser drawer until it stops. Measure out the amount of detergent required, pour it into the main wash compartment **[II]** and into the compartment marked **[I]** if you have selected the “prewash” option.

If required, pour fabric softener into the compartment marked **[III]** (the amount used must not exceed the “MAX” mark in the drawer). Close the drawer gently.

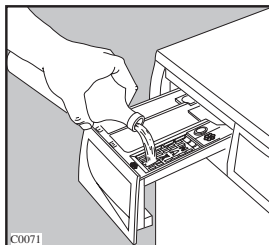
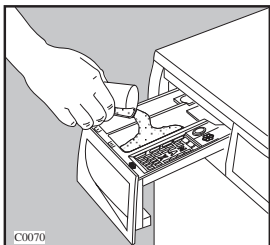

### 3. Select the required programme

Turn the programme selector dial to the programme **[90]**. The light “Start / Pause” starts to flash. The pilot lights corresponding to the various phases making up the programme come on.

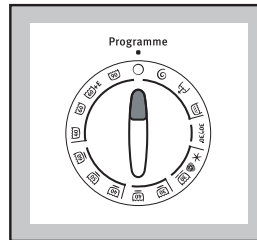

### 4. Select ↓⊙ (spin reduction) or ⊔ (rinse hold) option

Press the option button repeatedly, to select the desired option. The relevant light illuminates.

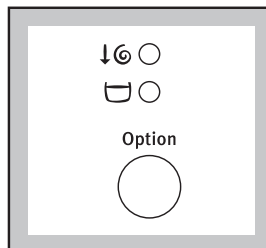

### 5. Select the required option

Select “Prewash”, “Super Rinse” or “Half Load” option if required, the corresponding light illuminates.

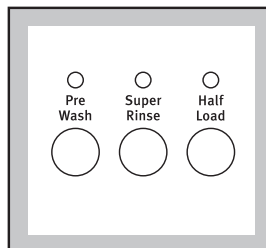



## 6. Start the programme

Before starting the machine check that:

- the appliance is plugged in
- the water supply tap is turned on
- the drain hose is correctly and securely positioned
- the door and the detergent dispenser drawer are closed.

To start the selected programme, press the **“Start / Pause”** button; the corresponding light stops flashing.

Only the **“washing”** light stays on.

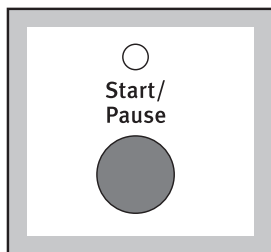

## 7. Altering a programme

You can alter the programme before it starts. When the programme has started, you can only reset it by turning the programme selector dial to **O** and then you can select the new programme. The washing water remains in the tub. Start the new programme by depressing the **“Start / Pause”** button.

## 8. Interrupting a programme

Depress the **“Start / Pause”** button to interrupt a programme which is running, the corresponding light starts to flash. Depress the button again to restart the programme.

## 9. Cancelling a programme

Turn the selector dial to **O** to cancel a programme which is running. Now you can select a new programme.

## 10. Opening the door after the programme has started

First set the machine to pause by pressing the **“Start / Pause”** button. Wait two or three minutes for the door lock to be released.

If the machine is already heating, or the water level is above the bottom edge of the door or the drum is turning, it means that the door can not be opened. If you cannot open the door but you need to open it you have to switch the machine off by turning the selector dial to **“O”**. After about 2 minutes the door can be opened (pay attention to the water level and temperature!).

## 11. At the end of the programme

The machine stops automatically.

If the **☒ (rinse hold)** option has been selected, the phase light **“End”** is on to indicate that the water must be emptied out before opening the door.

To do this first turn the programme selector dial to **“O”** and then to drain programme **☒** or spin programme **☉**. Release of the lock is indicated by the illumination of the **“End”** light.

Turn the programme selector dial to **“O”** to switch the machine off.

Remove the laundry from the drum and carefully check that the drum is empty.

If you do not intend to carry out another wash, close the water tap. Leave the door open to prevent the formation of mildew and unpleasant smells.

## WASHING 2 KG OF MIXED FABRICS AT 50°C

Suppose you have 2 kg of lightly soiled mixed fabrics to wash. They are rather delicate fabrics and should not be washed at a high temperature.



### 1. Load the laundry

Open the door by carefully pulling on the door handle outwards.

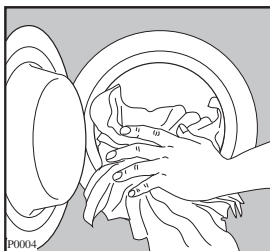
Place the laundry in the drum, one item at a time, shaking them out as much as possible. Close the door.



### 2. Measure out the detergent

Pull out the dispenser drawer until it stops. Measure out the amount of detergent required and pour it into the main wash compartment  and into the compartment marked  if you have selected the “prewash” option.

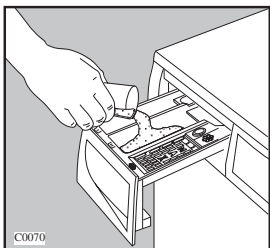

### 3. Measure out the fabric softener

If required, pour fabric softener into the compartment marked  (the amount used must not exceed the “MAX” mark in the drawer).

Close the drawer gently.

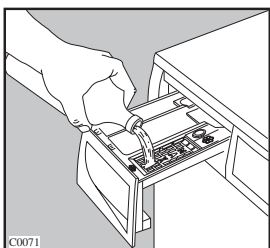

### 4. Select the required programme

Turn the programme selector dial to the programme . The “Start / Pause” light starts to flash. The pilot lights corresponding to the various phases making up the programme come on.

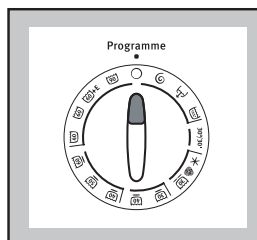

### 5. Select ↓⊙ (spin reduction) or (rinse hold) option

Press the option button repeatedly, to select the desired option. The relevant light illuminates.

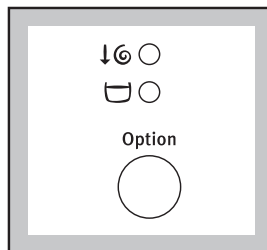

### 6. Select the required option

Select “Prewash” or “Super Rinse” option if required, the corresponding light illuminates.

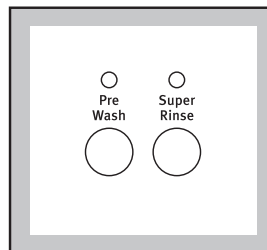

### 7. Start the programme

Before starting up the machine check that:

- the appliance is plugged in
- the water supply tap is turned on
- the drain hose is correctly and securely positioned
- the door and the detergent dispenser drawer are closed.

To start the selected programme, press the “**Start / Pause**” button; the corresponding light stops flashing.

Only the “**washing**” pilot light stays on.

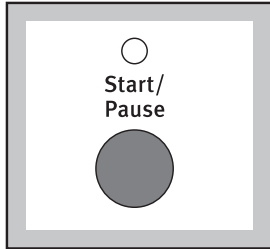

The machine starts operating.



## 8. At the end of the programme

The machine stops automatically.

If the  (**rinse hold**) option has been selected, the phase light “**End**” will illuminate to confirm that the water must be emptied out before opening the door.

To do this first turn the programme selector dial to “**O**” and then to drain programme  or spin programme .

In this case reduce the spin speed by means of the relevant button in order that the fabrics are spun at a suitable speed.

Release of the lock is indicated by the illumination of the “**End**” light.

Turn the programme selector dial to “**O**” to switch the machine off.

Remove the laundry from the drum and carefully check that the drum is empty.

If you do not intend to carry out another wash, close the water tap.

Leave the door open to prevent the formation of mildew and unpleasant smells.

# Washing Hints

Do **NOT** overload the machine. Weigh the laundry the first few times you use the appliance.

The average weights of the most common items are listed below as a guide:

## 1000g = 1 kg

Sheet	700-1000 g
Pillow case	100-200 g
Tablecloth	400-500 g
Serviette	50-100 g
Tea towel	70-120 g
Linen hand towel	100-150 g
Towelling hand towel	150-250 g
Towelling bath towel	700-1000 g
Bath robe	1000-1500 g
Man's shirt	200-300 g
Apron	150-200 g

- Load the laundry loosely alternating large items with small ones.
- Sort the laundry according to the type of fabric, colour-fastness and how dirty it is.
- Avoid washing unhemmed or torn items as they may unravel.
- Before washing, empty all pockets of small objects which may have been left inside (coins, keys, screws etc). as these could damage the drain pump.
- When washing curtains, remove the hooks.
- Close poppers and zips and fasten loose buttons.
- It is essential to wash new coloured items separately when washing for the first time.
- When washing fabrics requiring different wash temperatures together, always select the lowest temperature.
- White items should not be washed with coloured items.
- Very small items (handkerchiefs, ribbons, socks etc) should be washed in a washing bag or a pillow case.
- Use a good quality detergent suitable for automatic washing machines.
- Use the correct quantities of detergent.

- For wool, use gentle detergent only in small quantities.
- Bleach is very corrosive; it should be used with care and kept out of reach of children.
- Some stains such as fruit, wine, grass, rust etc. are difficult to remove and should be treated before washing with specific products, which can be found in most supermarkets. In some cases it may help to soak the stain before washing with a special pre-soak product or biological detergent.
- Only wool marked "Pure New Wool - washable, preshrunk" can be washed in the machine using the wool programme; other types of wool should be washed in HANDWASH programme.
- If you have used the machine to wash, rinse or spin only non-colour fast garments, there may be dye left in the sump. To ensure any subsequent wash is not contaminated with the dye, select and carry out a rinse and spin programme, without any garments, to ensure that any dye is removed from the sump.
- Once you have finished using the machine, you are advised to unplug it and turn off the water tap.

## Which detergent?....

To ensure you obtain the best wash results from your appliance, it is important to use the right detergent in your everyday wash, and only detergents recommended for use in automatic machines.

To maintain the appearance of your clothes and household textiles and to make them last longer you should use different types of detergent for different washes, whether for whites, colours or delicates.

### WHITES

We recommend the Ariel product range which is biological and designed to provide excellent cleaning and stain removal even at low temperatures.



### NON BIOLOGICAL

If you prefer to use a non biological detergent, which does not contain enzymes we recommend Fairy. Fairy provides good cleaning and stain removal.



### COLOURED

For coloured items you should use a detergent which is designed to clean while maintaining the original colour. Ariel Color does not contain bleach and therefore helps to preserve colours.



### DELICATE ITEMS

When washing delicates such as woollens, you should use a product which is specially designed to care for fine fabrics. Dreft Automatic is suitable for woollens and other delicates.



### LAUNDRY BLEACH

For additional stain removal you may wish to use a product such as Ace Gentle Bleach which is used in addition to your chosen detergent. Ace is suitable for all washable fabrics including silks, woollens and coloureds.



## And in which form?

Not only are there different types of detergent, but they are also available in different forms. Whether you chose a powder or liquid in traditional or compact form is your own personal choice.

### TRADITIONAL POWDERS

Pour the powder directly into the dispenser drawer. Do not sprinkle powder onto clothes in the machine drum.

### TRADITIONAL LIQUIDS

Liquid can be placed in the main wash compartment of the detergent drawer marked with the symbol , start the machine immediately upon placing the detergent in the dispenser drawer.

Alternatively the detergent is measured into the specially designed dosing device\* which should be placed on top of the laundry, and at the back of the machine drum.

### COMPACT POWDERS AND LIQUIDS

Compact detergents (or concentrates as they are also known) are available in liquid or powder form, and generally require a smaller dosage. Follow the manufacturer's instructions to ensure the most economical usage. Pour the detergent directly into the dispenser drawer, or alternatively measure the detergent into the specially designed dosing device\* which should be placed on top of the laundry, and at the back of the machine drum.

**\* If you use a dosing device in a washer dryer, please ensure the dosing device/ball is removed before carrying out a drying programme.**

### FABRIC CONDITIONERS

These are ideal for improving 'softness', and also reduce static cling on synthetics and make ironing easier. They are available in two types:

For example Lenor liquid fabric softener, for use in the **washing machine/washer dryer**. The liquid fabric softener should be poured into the compartment marked with the symbol . Follow the manufacturer's dosage instructions and never exceed the MAX level.

















Bounce conditioning sheets for use in a **tumble dryer**. We recommend the conditioning sheets are pinned (using a safety pin) to an article of laundry and placed in the tumble dryer.



# Wash Care Symbols

Wash care labels inside garments recommend how to launder your clothes with the best results. The care labelling code is in line with care labelling used in the rest of Europe. The symbols used make it easy to select the correct programme on your washing machine.

WASHING SYMBOL	WASH ACTION	FABRIC
	Normal (Maximum)	White Cotton or Linen without Special Finishes
	Normal (Maximum)	Cotton, Linen or Viscose without Special Finishes Colourfast at 60°C.
	Reduced (Medium)	Nylon, Polyester/Cotton, Viscose with Special Finishes, Cotton/Acrylic Mix.
	Normal (Maximum)	Cotton, Linen or Viscose Colourfast at 40°C but not 60°C.
	Reduced (Medium)	Acrylics, Acetate, Triacetate, Wool mixes, Polyester/wool blends.
	Much Reduced (Minimum)	Wool, wool mixtures, Silks
	Hand wash only	Do not machine wash
<b>BLEACHING</b>		
	Chlorine bleach may be used	
<b>IRONING</b>		
	Hot iron	Cotton, Linen, Viscose
	Warm iron	Polyester mixtures, Wool
	Cool iron	Acrylic, Nylon, Polyester
<b>DRY CLEANING</b>		
	May be dry cleaned. Other letters and/or a bar beneath the circle will indicate the required process to the dry cleaner.	
<b>TUMBLE DRYING</b>		
	with high heat setting	
	with low heat setting	
	May be tumble dried	
<b>X</b>	A cross through any symbol means « <b>DO NOT</b> »	

## Important Notes













For best results, always use the dispenser drawer for dispensing detergents and liquid additives. Once the dispenser has been filled, close it by pushing it in gently. This is particularly important if you are using

fabric conditioner to avoid the conditioner entering the machine prematurely.

When using liquid detergent and a prewash programme, place the detergent into the correct compartment in the dispenser drawer, after the prewash has finished.

# Washing Programmes

## Programmes for cotton and linen



























Wash programme/ Washing symbol	Degree of soil and type of laundry	Programme dial position	Description	Possible options	Max. load	Progr. time mins.
WHITES	For heavy soiled cotton items.		Wash at 90°C 3 rinses Long spin	  Prewash Super Rinse Half Load	5 kg	140
WHITES + ECONOMY	White cotton, for example normally soiled work garments, sheets, household linen, underwear, towels.	 (* )	Wash at 60 °C 3 rinses Long spin	  Prewash Super Rinse Half Load	5 kg	125
FAST COLOURED	Fast coloured cotton or linen fabrics, normally soiled, shirts, underwear, towels.		Wash at 60 °C 3 rinses Long spin	  Prewash Super Rinse Half Load	5 kg	115
NON FAST COLOURED	Non fast coloured cotton or linen fabrics, normally soiled, shirts, blouses, underwear.		Wash at 40 °C 3 rinses Long spin	  Prewash Super Rinse Half Load	5 kg	113
RESET / OFF	For cancelling the wash programme which is running and for switching the machine off					

(\* ) This programme is the reference programme for the Energy label according to EEC Directive 92/75.

The programme times are intended as a guide only. The actual time will vary depending on incoming water temperature and pressure.

# Washing Programmes

## Programmes for synthetics, mixed fabrics, delicates and wool

Wash programme/ Washing symbol	Degree of soil and type of laundry	Programme dial position	Description	Possible options	Max. load	Progr. time mins.
COLOUR-FAST FABRICS	Synthetic or mixed fabrics, underwear, coloured garments, non-shrink shirts, blouses.		Wash at 60 °C	  <b>PREWASH</b> <b>SUPER RINSE</b> <b>HALF LOAD</b>	2 kg	90
MINIMUM IRON			Wash at 50 °C			85
MIXED FABRICS			Wash at 40 °C			80
			3 rinses Short spin			
DELICATES	Delicate fabrics, for example curtains or colour care fabrics		Wash at 40 °C	  <b>PREWASH</b> <b>SUPER RINSE</b> <b>HALF LOAD</b>	2 kg	60
COLOUR CARE			Wash at 30 °C			55
			3 rinses Short spin			
WOOL 	Specially tested programme for wool garments bearing the “Pure new wool, non- shrink, machine washable” label.		Wash at 30 °C 3 rinses Short spin	  <b>HALF LOAD</b>	1 kg	50
WOOL COLD	Special programme for hand washing fabrics		Cold wash 3 rinses Short spin	  <b>HALF LOAD</b>	1 kg	43
WORN ONCE	Special short programme for lightly soiled synthetic, mixed fabrics and delicates	30°/30'	Wash at 30 °C 2 rinses Short spin	  <b>HALF LOAD</b>	2 kg	30
RINSES	Separate rinse cycle for hand washed items of all fabric		3 rinses Short spin	  <b>SUPER RINSE</b>	5 kg	30
DRAIN	For emptying out the last rinse water in programmes with the  ( <b>rinse hold</b> ) option.		Draining of water	-		4
SPIN	Separate spin for all fabric	 (*)	Spin		5 kg	1,5
RESET / OFF	For cancelling the wash programme which is running and for switching the machine off					

(\*) If the  (Spin reduction) option has been selected for this programme, the programme will perform a short spin.



# Maintenance and Cleaning

Before any maintenance or cleaning is carried out you must **DISCONNECT** the appliance from the electricity supply.

## Descaling

The water we use normally contains lime. It is a good idea to periodically use a water softening powder in the machine. Do this separately from any laundry washing, and according to the softening powder manufacturer's instructions. This will help to prevent the formation of lime deposits.

## After each wash

Leave the door open for a while. This helps to prevent mould and stagnant smells forming inside the appliance. Keeping the door open after a wash will also help to preserve the door seal.

## Maintenance Wash

With the use of low temperature washes it is possible to get a build up of residues inside the drum. We recommend that a maintenance wash be performed on a regular basis.

### To run a maintenance wash:

- The drum should be empty of laundry.
- Select the hottest cotton wash programme.
- Use a normal measure of detergent, must be a powder (such as Ariel Futur).

## External cleaning

Clean the exterior cabinet of the appliance with a mild solution of washing up liquid and water only, and then dry thoroughly.

## Cleaning the dispenser drawer

The washing powder and additive dispenser drawer should be cleaned regularly. Remove the drawer by pressing the catch downwards and by pulling it out. Flush it out under a tap, to remove any traces of accumulated powder. To aid cleaning, the top part of the additive compartment should be removed.

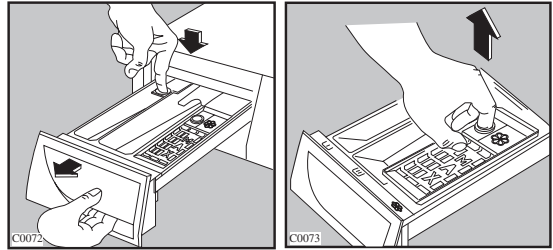

## Cleaning the drawer recess

Having removed the drawer, use a small brush to clean the recess, ensuring that all washing powder residue is removed from the upper and lower part of the recess. Replace the drawer and run the rinse programme without any clothes in the drum.

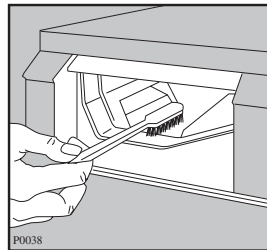

## Cleaning the pump

The pump should be inspected regularly and particularly if

- the machine does not empty and/or spin
- the machine makes an unusual noise during draining due to objects such as safety pins, coins etc. blocking the pump.

Proceed as follows:

- Disconnect the appliance.
- If necessary wait until the water has cooled down.
- Open the pump door.

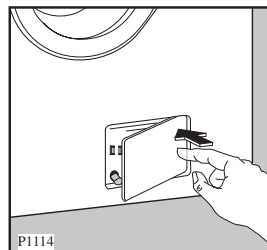

- Place a container close to the pump to collect any spillage.
- Pull out the emergency emptying hose, place it in the container and remove its cap.

- When no more water comes out, unscrew the pump cover and remove it. Always keep a cloth nearby to dry up spillage of water when removing the cover.

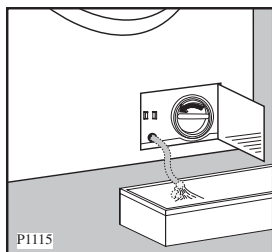

- Remove any objects from the pump impeller by rotating it.

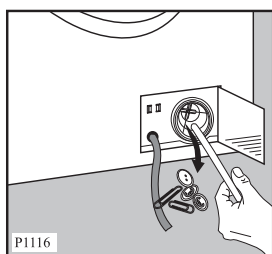

- Put the cap back on the emergency emptying hose and place the latter back in its seat.

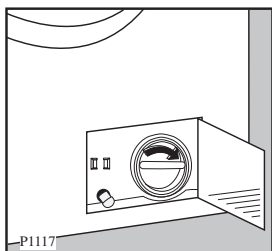

- Screw the pump cover fully in.
- Close the pump door.

### **Warning**

When the appliance is in use and depending on the programme selected there can be hot water in the pump. Never remove the pump cover during a wash cycle, always wait until the appliance has finished the cycle, and is empty. When replacing the cover, ensure it is securely retightened so as to stop leaks and young children being able to remove it.

## Cleaning the water inlet filter

If your water is very hard or contains traces of lime deposit, the water inlet filter may become clogged. It is therefore a good idea to clean it from time to time. Turn off the water tap. Unscrew the water inlet hose.

Clean the filter using a hard bristle brush. Tighten up the inlet hose.

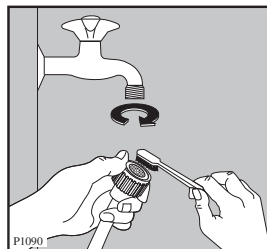

## The dangers of freezing

If the machine is exposed to temperatures below 0°C, certain precautions should be taken.

- Turn off the water tap.
- Unscrew the inlet hose.
- Place the end of the emergency emptying hose and that of the inlet hose in a bowl placed on the floor and let water drain out.
- Screw the water inlet hose back on and reposition the emergency emptying hose after having put the cap on again.
- When you intend to start the machine up again, make sure that the room temperature is above 0°C.

### **Important!**

Every time you drain the water through the emergency emptying hose you must pour 2 litres of water into the main wash compartment of the detergent drawer and then run the drain programme. This will activate the ECO valve avoiding that part of the detergent remains unused at next washing.

## Emergency emptying out

If the water is not discharged, proceed as follows to empty the machine:

- pull out the plug from the power socket;
- close the water tap;
- if necessary, wait until the water has cooled down;
- open the pump door;
- place a bowl on the floor and place the end of the emergency emptying hose into the bowl. Remove its cap. The water should drain by gravity into the bowl. When the bowl is full, put the cap back on the hose. Empty the bowl. Repeat the procedure until water stops flowing out;
- clean the pump if necessary as previously described;
- replace the emergency emptying hose in its seat after having plugged it;
- screw the pump cover again and close the door.

# Something Not Working

Certain problems are due to lack of simple maintenance or oversights, which can be solved easily without calling out an engineer. Before contacting your local Service Force Centre, please carry out the checks listed below.

During machine operation it is possible that the “End” light flashes to indicate that the machine is not working.

- 4 flashes = door open
- 2 flashes = the water is not drained
- 1 flash = there is no water filling

Once the problem has been eliminated, press the “Start / Pause” button to restart the programme. If after all checks, the problem persists, contact your local Service Centre.

**IMPORTANT: if you call out an engineer to a fault listed below, or to repair a fault caused by incorrect use or installation, a charge will be made even if the appliance is under guarantee.**

Symptom	Possible causes
<b>The machine does not start</b>	<ul style="list-style-type: none"> <li>• The door has not been closed.</li> <li>• The plug is not properly inserted in the power socket.</li> <li>• There is no supply at the socket</li> <li>• The main fuse or the fuse in the plug has blown.</li> <li>• The selector dial is not correctly positioned and the “Start / Pause” button has not been depressed.</li> </ul>
<b>The machine does not fill</b>	<ul style="list-style-type: none"> <li>• Ensure the water tap is open.</li> <li>• The filter in the inlet hose is blocked.</li> <li>• The inlet hose may be squashed or kinked.</li> <li>• The door has not been closed.</li> </ul>
<b>The machine fills then empties immediately</b>	<ul style="list-style-type: none"> <li>• The end of the drain hose is too low.</li> <li>• The end of the drain hose is submerged in water.</li> <li>• There is no vent in the end of the drain hose.</li> </ul>
<b>The machine does not empty and/or does not spin</b>	<ul style="list-style-type: none"> <li>• The drain hose may be squashed or kinked.</li> <li>• The  (rinse hold) option has been selected.</li> <li>• The drain pump may be blocked.</li> <li>• The drain hose extension, if fitted, is not correct. Follow the instructions for connecting to the waste.</li> <li>• The drainage system pipes are blocked.</li> <li>• The wash load is unbalanced: redistribute the clothes inside the drum to allow the machine to spin.</li> </ul>
<b>There is water on the floor</b>	<ul style="list-style-type: none"> <li>• Too much detergent or unsuitable detergent has been used (creates too much foam).</li> <li>• Check whether there are any leaks from one of the inlet hose fittings. It is not always easy to see this as the water runs down the hose; check to see if it is damp.</li> <li>• The drain hose may be damaged or not securely positioned.</li> <li>• The detergent dispenser drawer or recess is clogged.</li> <li>• The drainage system pipes are blocked.</li> <li>• The cap on the emergency emptying hose has not been replaced after cleaning the filter.</li> </ul>
<b>Unsatisfactory washing results</b>	<ul style="list-style-type: none"> <li>• Too little detergent or unsuitable detergent has been used. An insufficient amount of detergent leaves the laundry looking grey and allows lime scale to form.</li> <li>• Stubborn stains have not been treated prior to washing</li> <li>• The correct wash programme has not been selected.</li> <li>• Too much laundry has been placed in the drum.</li> </ul>

Symptom	Possible causes
<b>The machine vibrates when spinning</b>	<ul style="list-style-type: none"> <li>• The internal packing has not been removed.</li> <li>• The machine is in contact with the wall or furniture.</li> <li>• The machine is not stable and level (check diagonally).</li> <li>• The washing load is badly distributed in the drum.</li> <li>• Maybe there is very little laundry in the drum.</li> </ul>
<b>The door will not open</b>	<ul style="list-style-type: none"> <li>• The programme is still running.</li> <li>• The door lock has not yet released.</li> <li>• Water in the tub: the door cannot be opened if water is present in the tub.</li> </ul>
<b>Spinning starts late or the machine does not spin</b>	<ul style="list-style-type: none"> <li>• The electronic unbalance detection device has cut in because the laundry is not evenly distributed in the drum. The laundry is redistributed by reverse rotation of the drum. This may happen several times before the unbalance disappears and normal spinning can resume. If, after 10 minutes, the laundry is still not evenly distributed in the drum, the machine will not spin. In this case, redistribute the load manually and reselect the spin programme.</li> </ul>
<b>The machine makes an unusual noise</b>	<ul style="list-style-type: none"> <li>• The machine is fitted with a type of motor which makes an unusual noise compared with other traditional motors. This new motor ensures a softer start and more even distribution of the laundry in the drum when spinning, as well as increased stability of the machine.</li> </ul>
<b>No water is visible in the drum</b>	<ul style="list-style-type: none"> <li>• Machines based on modern technology operate very economically using very little water without affecting performance.</li> </ul>

## Service & Spare Parts

In the event of your appliance requiring service, or if you wish to purchase spare parts, please contact your local Zanussi Electrolux Service Force Centre by telephoning:

**0870 5 929929**

Your telephone call will be automatically routed to the Service Force Centre covering your post code area. For the address of your local Zanussi Electrolux Service Force Centre and further information about Service Force, please visit the website at [www.serviceforce.co.uk](http://www.serviceforce.co.uk).

For Customer Service in Ireland please contact us at the address below:

Zanussi Electrolux  
Electrolux Group (Irl) Ltd  
Long Mile Road  
Dublin 12  
Republic of Ireland  
Tel: +353 (0)1 4090751  
Email: [service.eid@electrolux.ie](mailto:service.eid@electrolux.ie)

Before calling out an engineer, please ensure you have read the details under the heading “Something Not Working”.

When you contact the Service Force Centre you will need to give the following details:

1. Your name, address and post code
2. Your telephone number
3. Clear and concise details of fault
4. The model and serial number of the appliance (found on the rating plate - see picture).
5. The purchase date

**Please note that a valid purchase receipt or guarantee documentation is required for in-guarantee service calls**

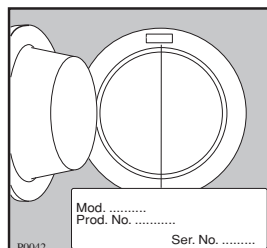

## Customer Care

For general enquiries concerning your Zanussi Electrolux appliance or for further information on Zanussi Electrolux products, please contact our Customer Care Department by letter or telephone as follows:

Zanussi Electrolux  
Customer Care (Major Appliances)  
Addington Way  
Luton  
Bedfordshire  
LU4 9QQ  
Tel 08705 727727\*  
or visit our website at: [www.zanussi-electrolux.co.uk](http://www.zanussi-electrolux.co.uk)  
\* calls to this number may be recorded for training purposes.

# Guarantee Conditions

## Standard guarantee conditions

We, Zanussi Electrolux undertake that if, within 12 months of the date of the purchase, this Zanussi Electrolux appliance or any part thereof is proved to be defective by reason only of faulty workmanship or materials, we will, at our option, repair or replace the same FREE OF ANY CHARGE for labour, materials or carriage on condition that:

- The appliance has been correctly installed and used only on the electricity supply stated on the rating plate.
- The appliance has been used for normal domestic purposes only, and in accordance with the manufacturer's instructions.
- The appliance has not been serviced, maintained, repaired, taken apart or tampered with, by any person not authorised by us.

All service work under this guarantee must be undertaken by a Zanussi Electrolux Service Force Centre.

Any appliance or defective part replaced shall become the Company's property.

This guarantee is in addition to your statutory and other legal rights.

Home visits are made between **8.30am** and **5.30pm** Monday to Friday. Visits may be available outside these hours in which case a **premium** will be charged.

## Exclusions

### This guarantee does not cover:

- Damage or calls resulting from transportation, improper use, neglect or removable parts of glass or plastic.
- Costs incurred for calls to put right an appliance which is improperly installed or calls to appliances outside the United Kingdom.

- Appliances found to be in use within a commercial environment, plus those which are subject to rental agreements.
- Products of Zanussi Electrolux manufacture which are NOT marketed by Zanussi Electrolux.

## European guarantee

If you should move to another country within Europe then your guarantee moves with you to your new home subject to the following qualifications:

- The guarantee starts from the date you first purchased your product.
- The guarantee is for the same period and to the same extent for labour and parts as exists in the new country of use for this brand or range of products.
- The guarantee relates to you and cannot be transferred to another user.
- Your new home is within the European Community (EC) or European Free Trade Area.
- The product is installed and used in accordance with our instructions and is only used domestically, i.e. a normal household.
- The product is installed taking into account regulations in your new country.

Before you move please contact your nearest Customer Care Centre, listed below, to give them details of your new home. They will then ensure that the local Service Organisation is aware of your move and able to look after you and your appliances.

France	Senlis	+33 (0)344 62 29 29
Germany	Nurnberg	+49 (0)800 234 7378
Italy	Pordenone	+39 (0)434 39 47 00
Sweden	Stockholm	+46 (0)8 672 53 90
UK	Luton	+44 (0)8705 727727

# Installation Instructions

- ⚠ It is dangerous to alter the specifications or attempt to modify this product in any way.
- ⚠ Care must be taken to ensure that the appliance does not stand on the electrical supply cable.
- ⚠ Any electrical work required to install this appliance should be carried out by a qualified electrician or competent person.
- ⚠ Any plumbing work required to install this appliance should be carried out by a qualified plumber or competent person.
- ⚠ Should the appliance power supply cable need to be replaced, this should be carried out by our Service Force Centre.

# Technical Specifications

DIMENSIONS	Height Width Depth	85 cm 60 cm 60 cm
POWER SUPPLY VOLTAGE TOTAL POWER ABSORBED		230-240 V/50 Hz 2100 W (10A)
WATER PRESSURE	Minimum Maximum	50 kPa (0.5 bar) 800 kPa (8 bar)
MAXIMUM RECOMMENDED LOAD	Cotton, linen Synthetics Delicate fabrics Wool	5 kg 2 kg 2 kg 1 kg
SPIN SPEED	Maximum	1000 rpm
CONSUMPTION DATA FOR WASHING 5 KG NORMALLY SOILED COTTON ITEMS AT 60°C (PROGR. <b>ECO WASH</b> )	Energy Water	0.95 kWh 49 litres



This appliance complies with the following E.E.C. Directives:

- 73/23 EEC of 19.2.73 (Low Voltage Directive) and subsequent modifications;
- 89/336 EEC of 3.5.89 (Electromagnetic Compatibility Directive) and subsequent modifications.

## Unpacking

**⚠ All transit bolts and packing must be removed before using the appliance**

You are advised to keep all the packaging for re-use in case the appliance has to be transported again.

- Unscrew and remove the three rear transit bolts (using a spanner).

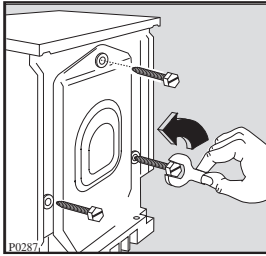

- Lay the machine gently on its back, making sure that the hoses are not squashed.

We suggest a polystyrene angle bracket from the packing is placed on the floor before tilting it back to avoid the hoses being spacers.

- Carefully remove the polyethylene bags located at the base of the machine by pulling them toward the centre of the machine.

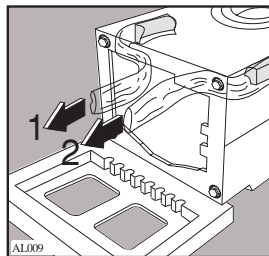
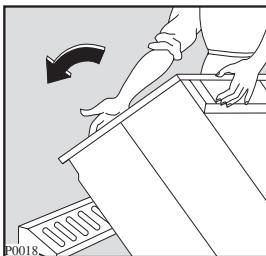

- Place the machine in an upright position and remove the three plastic spacers.

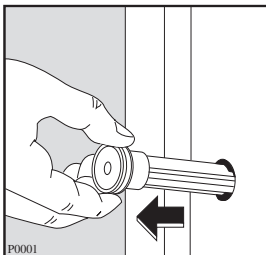

- Plug the 3 holes with the plastic plugs which you can find in the envelope containing the instruction booklet.

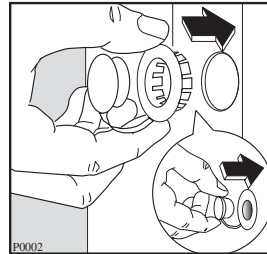

### Important !

**You are advised to keep all the packaging for re-use in case the machine is to be transported again. In case of moving out the same precautions as per paragraph “The dangers of freezing” must be taken i.e. the residual water in the hoses must be pumped out.**

## Positioning

Install the machine on a flat hard floor.

Make sure that air circulation around the machine is not impeded by carpets, rugs etc. Check that the machine does not touch the wall or other kitchen units.

Never place cardboard, wood or similar materials under the machine to compensate for any unevenness in the floor.

Your new washing machine has been designed to be permanently plumbed in to your home's water supply and drainage system. However, if this is not possible, it may be connected to suitable existing tap with the drain hose discharging into a sink.

The appliance has one inlet hose, with female 3/4" BSP thread connector. If this connection is not compatible with the plumbing of the existing installation, a variety of connectors are available from good hardware stores and plumbers merchants to suit most domestic plumbing. Any alteration to your existing plumbing must be carried out by a competent person, or qualified plumber.

## Installation on a Suspended Floor

Suspended wooden floors are particularly susceptible to vibration. To help prevent vibration we recommend you place a waterproof wood panel, at least 15 mm thick under the appliance, secured to at least 2 floor beams with screws. If possible install the appliance in one of the corners of the room, where the floor is more stable.

## Water inlet

Connect the hose to a tap with a 3/4" thread.  
Do not use previously used hoses for water connection.

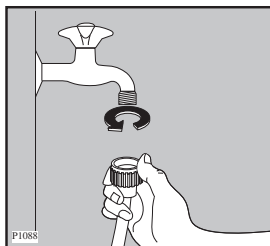

Installation should comply with local water authority and building regulations' requirements.

### The appliance must be connected to a cold water supply.

A minimum water pressure of 50 kPa (0.5 bar) is required for safe operation of the appliance.

If you cannot make the cold water connection direct from the rising mains, you may be able to operate the appliance from your cold water storage system.

There should be a minimum distance of 5.02m (16.5 ft) between the appliance's inlet and the bottom of the water storage tank.

Set the hose correctly by loosening the ring nut. After positioning the inlet hose, be sure to tighten the ring nut again to prevent leaks.

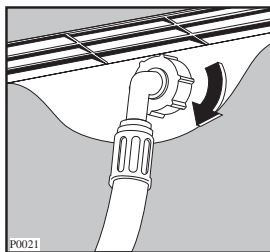

## Water drainage

This appliance is designed to be permanently plumbed into your home's drainage system using one of the following methods.

### 1. Into a drainage standpipe.

Firstly form a hook in the end of the drain hose using the "U" piece supplied.

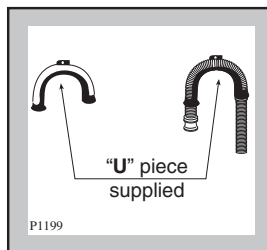

Place the drain hose into your standpipe, which should have an internal diameter of approximately 38mm thus ensuring there is an air break between the drain hose and standpipe.

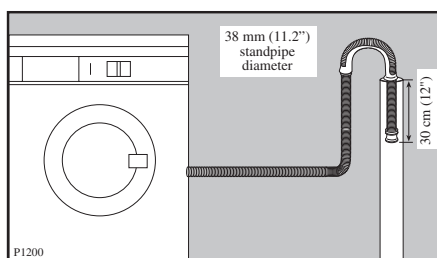

When discharging into a standpipe ensure that the top of the standpipe is no more than 90cm (35.4") and no less than 60cm (23.6") above floor level.

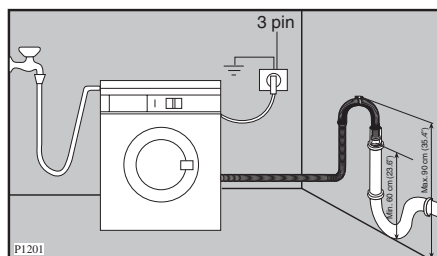

The drain hose may be extended to a maximum of 4 metres. An additional drain hose and joining piece is available from your local Service Force Centre. The joining piece must have an internal diameter of 18mm.

If your drain hose looks like this (see below) you do not require the "U" piece". Just push the hose firmly into the standpipe.

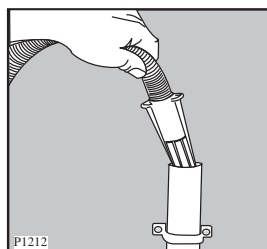



## 2. Onto a sink outlet spigot.

If the outlet spigot has not been used before, remove any blanking plug that may be in place.

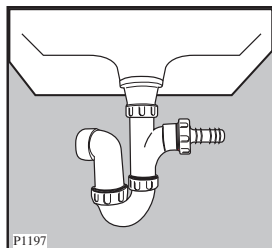

Push the drain hose onto the spigot and secure with a clip if required, ensure a loop is formed in the drain hose (see diagram) to prevent waste from the sink entering the washing machine.

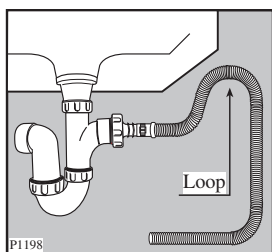

The drain hose may be extended to a maximum of 4 metres. An additional drain hose and joining piece is available from your local Service Force Centre. The joining piece must have an internal diameter of 18mm.

### Important

- Before connecting the machine to new pipework or to pipework that has not been used for some time, run off a reasonable amount of water to flush out any debris that may have collected in the pipes.

### Levelling

Level the washing machine by raising or lowering the feet.

The feet may be tight to adjust as they incorporate a self locking nut, but the machine **MUST** be level and stable.

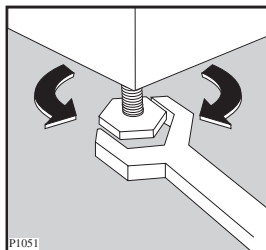

Any necessary adjustment can be made with a spanner. Accurate levelling prevents vibration, noise and displacement of the machine during operation.

Some vibration is inevitable, especially if mounted on a wooden floor.

Sprung wooden floors are particularly susceptible to vibration. For advice, consult a builder. If possible, always place the machine on a solid floor.

### Special conditions

If the floor is carpeted or covered with crumbly or soft material, insert a rigid support base under the feet to prevent noise, vibration or displacement. The base should protrude a few centimetres beyond the edges of the machine.



#### Warning

The machine should **NOT** be placed on deep pile carpeting.

#### Note

Please ensure that when the appliance is installed it is easily accessible for the engineer in the event of a breakdown.

### In the interest of the environment

Washing machines and dishwashers should be connected to the FOUL drainage system, the water will then be taken to a sewage works for treatment before being discharged safely into a river.

It is essential that these appliances are not connected to the surface water drainage system as this water is discharged directly into a river or stream and may cause pollution.

If you require any further advice please contact your local water authority.

## Electrical connection

Any electrical work required to install this appliance should be carried out by a qualified electrician or competent person.

**! WARNING: THIS APPLIANCE MUST BE EARTHED.**

**The manufacturer declines any liability should this safety measure not be observed.**

Before switching on, make sure the electricity supply voltage is the same as that indicated on the appliance's rating plate. The rating plate is located at the top of the rim of the open door.

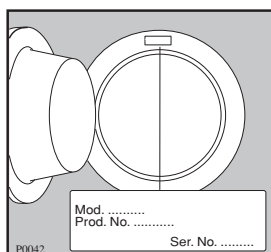

The appliance is supplied with a 13amp plug fitted. In the event of having to change the fuse in the plug supplied, a 13amp ASTA approved (BS1363A) fuse must be used.

Should the plug need to be replaced for any reason, proceed as described below.

The wires in the mains lead are coloured in accordance with the following code:

- Green and Yellow - Earth
- Blue - Neutral
- Brown - Live

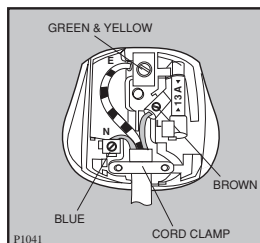

The wire coloured green and yellow must be connected to the terminal marked with the letter «E» or by the earth symbol  $\perp$  or coloured green and yellow.

The wire coloured blue must be connected to the terminal marked «N» or coloured black.

The wire coloured brown must be connected to the terminal marked «L» or coloured red.

Upon completion there must be no cut, or stray strands of wire present and the cord clamp must be secure over the outer sheath.

### WARNING:

**! A cut off plug inserted into a 13 amp socket is a serious safety (shock) hazard. Ensure that the cut off plug is disposed of safely.**

**Should the appliance power supply cable need to be replaced, this should be carried out by your local Zanussi Electrolux Service Force Centre.**

### Note

When the appliance is installed the power supply cable must be accessible.

## Permanent connection

In the case of permanent connection it is necessary that you install a double pole switch between the appliance and the electricity supply (mains), with a minimum gap of 3mm between the switch contacts and of a type suitable for the required load in compliance with the current electrical regulations.

The switch must not break the yellow and green earth cable at any point.



 **From the Electrolux Group. The world's No. 1 choice.**

*The Electrolux Group is the world's largest producer of powered appliances for kitchen, cleaning and outdoor use. More than 55 million Electrolux Group products (such as refrigerators, cookers, washing machines, vacuum cleaners, chain saws and lawn mowers) are sold each year to a value of approx. USD 14 billion in more than 150 countries around the world.*