

INSTRUCCIONES PARA INSTALACION Y USO  
INSTALLATION AND INSTRUCTION MANUAL

**ZANUSSI**

**LAVADORA  
WASHING MACHINE**

**FL 1014 V1**

This new washing machine meets all requirements for a modern washing of laundry with reduced consumption of water, energy and detergent.

- **The temperature selector dial** allows you to choose personally the suitable washing temperature for your laundry.
- **The automatic cooling** of the washing water from 90°C to 60°C before draining will prevent plastic pipes of your drainage system from being deformed.

### Ecological hints

In order to obtain water and energy savings and to protect the environment, we advise you to follow these instructions:

- Always wash full loads for maximum savings. Do not overload the appliance.
- Use a programme with prewash only for heavy soiled items.
- Measure out detergent according to the water hardness, degree of soiling and quantity of laundry being washed.



### Protection of the environment

- Materials marked with the  symbol are recyclable. To enable them to be recycled, they must be placed in the appropriate collection areas (or containers). Check with your local authorities.
  - >PE<= polyethylene
  - >PS<= polystyrene
  - >PP<=polypropylene
- When the appliance is to be scrapped, cut off the power supply cable and make the door closing device inoperative to avoid it becoming a death trap for a child.

The appliance which you have just bought is supplied not only with this instruction book, but also with a Guarantee Card, on the back of which are written the relative conditions.

Please fill in the necessary details on the Card and send it to the **ZANUSSI Centre** relative to the area in which the appliance is to be installed, within twenty days of the date of purchase. (See list of Zanussi network centres).

#### We congratulate you on your choice.

**Carefully read** this instruction book and follow attentively the recommendations it provides, and thus benefit from years of excellent service.

The appliance which you have just purchased has been **very accurately controlled** throughout the entire manufacturing process. Nevertheless, should any problem arise during usage, whether it be during the **warranty** period, or when such period has expired, please **directly** contact your nearest **ZANUSSI Service Centre**.

The address and telephone number of said Centre can be easily found in the enclosed **List**.

Our **ZANUSSI Service Network** is at your complete disposal, to serve you with **maximum speed and efficiency**, all you have to do is call.

# CONTENTS

<b>Important information</b> .....	.23	<b>Maintenance</b> .....	.36
<b>Description of the appliance</b> .....	.24	■ Bodywork .....	.36
■ Detergent dispenser drawer .....	.24	■ Detergent dispenser drawer .....	.36
<b>Technical specifications</b> .....	.24	■ Water inlet filter .....	.36
<b>Installation</b> .....	.25	■ Drain filter .....	.37
■ Unpacking .....	.25	■ The dangers of freezing .....	.37
■ Positioning .....	.25	<b>Something not working</b> .....	.38-39
■ Water inlet .....	.26		
■ Water drainage .....	.26		
■ Electrical connection .....	.26		
■ Door reversal & Fitting a door panel .....	.27		
<b>Use</b> .....	.28		
■ Control panel .....	.28		
■ Washing hints .....	.29		
Sorting the laundry .....	.29		
Temperatures .....	.29		
Before loading the laundry .....	.29		
Maximum loads .....	.29		
Laundry weights .....	.29		
Removing stains .....	.29		
Detergents and additives .....	.30		
■ International wash code symbols .....	.31		
■ Washing programmes .....	.32-33		
■ Operating sequence .....	.34-35		



## IMPORTANT INFORMATION

*It is important that this instruction book be kept with the appliance for future reference. If you sell or give the appliance away, make sure that the book is passed to the new owners so that they can familiarise themselves with its operation and relevant warnings.*

*The following warnings are provided in the interests of overall safety. You must read them carefully before installing or using the appliance.*

### Installation

- When unpacking the appliance, check that it is not damaged. If in doubt, do not use it and contact the Service Centre.
- All internal packing must be removed before using the appliance. Serious damage may be caused to the machine or adjacent furniture if the protective transit devices are not removed or are not completely removed. Refer to the relevant paragraph in the instruction book.
- Any electrical work required to install this appliance must be carried out by a qualified electrician.
- Any plumbing work required to install this appliance must be carried out by a qualified plumber.
- After having installed the machine, check that it is not standing on its electrical supply cable.
- If the appliance is placed on a carpeted floor, ensure that air can circulate freely between the adjustable feet and the floor.

### Use

- This appliance is designed for domestic use. It must not be used for purposes other than those for which it was designed.
- Do not overload the appliance. Follow the instructions in the instruction book.
- Only wash fabrics which are designed to be machine washed. Follow the instructions on each garment label.
- Make sure that all pockets are empty. Objects such as coins, safety pins, pins and screws can cause extensive damage.
- Do not machine wash garments saturated with petroleum, methylated spirits, trichlorethylene, etc. If such fluids have been used to remove stains prior to washing, wait until they have completely evaporated from the fabric before placing garments in the appliance.

- Place small items such as socks, belts, etc. in a cloth bag or pillowcase to prevent them getting trapped between the drum and the tub.
- Use only the recommended quantities of fabric softener. An excessive amount could damage the laundry.
- Leave the porthole door slightly ajar when the appliance is not in use. This preserves the door seal and prevents the formation of musty smells.
- Always check that water has emptied out before opening the door. If not, drain the water following the instructions in the instruction book.
- Always unplug the appliance and shut the water tap after use.

### Service/repair

- In the event of a fault, do not attempt to repair the appliance yourself. Repairs carried out by inexperienced persons may cause damage.
- If repairs are needed, contact an authorised service centre and ask for genuine spare parts.

### Safety

- This appliance is designed to be used by adults. Children must not be allowed to touch the controls or play with the product.
- During high temperature wash cycles the glass door becomes very hot. Do not touch it.
- Pets sometimes climb into washing machines. Check the drum before each use.



## DESCRIPTION OF THE APPLIANCE

- 1 Detergent dispenser drawer
- 2 Programme chart
- 3 Spin speed selector dial
- 4 ON/OFF button
- 5 Option buttons
- 6 Temperature selector dial
- 7 Operating pilot light
- 8 Programme selector dial
- 9 Door handle
- 10 Drain filter
- 11 Adjustable feet

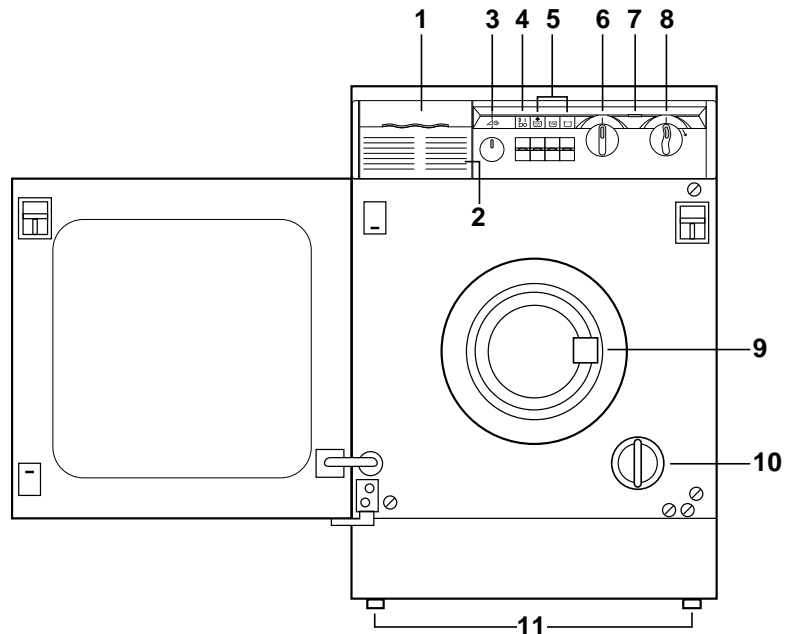

### Detergent dispenser drawer

#### Symbols



Prewash



Main wash



Bleaching agent



Fabric softener

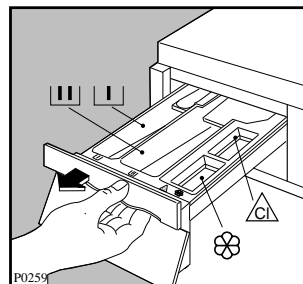

## TECHNICAL SPECIFICATIONS

DIMENSIONS	Height	85 cm
	Width	60 cm
	Depth	57 cm
POWER SUPPLY VOLTAGE/FREQUENCY		220-230V/50 Hz
TOTAL POWER ABSORBED		2200 W
MINIMUM FUSE PROTECTION		10 A
WATER PRESSURE	Minimum	5 N/cm <sup>2</sup>
	Maximum	80 N/cm <sup>2</sup>
MAXIMUM LOAD	Cotton	4.5 kg
	Synthetics, delicate fabrics	2 kg
	Woollens	1 kg
SPIN SPEED		1000 rpm



This appliance complies with the following EEC Directives:  
 73/23/EEC of 19/02/73 relating to low voltage  
 89/336/EEC of 03/05/89 relating to electromagnetic compatibility

# INSTALLATION

## Unpacking



All transit bolts and packing must be removed before using the appliance.

You are advised to keep all transit devices so that they can be refitted if the machine ever has to be transported again.

1. Using a spanner, unscrew and remove the rear right-hand bolt and lay the machine on its back, taking care not to squash the hoses. This can be avoided by placing one of the corner packing pieces between the machine and the floor.
2. Remove the polystyrene block from the bottom of the machine and release the two plastic bags by removing the adhesive strip.
3. Carefully remove the right-hand bag (1) then the left-hand bag (2) by pulling them towards the centre of the machine.
4. Set the machine upright and remove the two remaining bolts from the back.
5. Pull out the three plastic spacers from the holes into which the bolts were fitted.
6. Plug the open holes with the plugs which you will find at the back of the appliance.

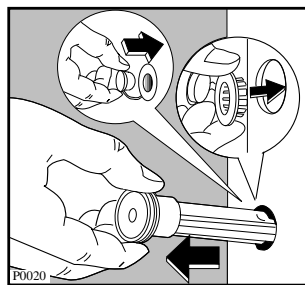
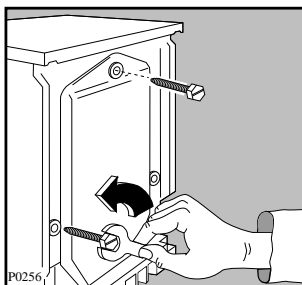
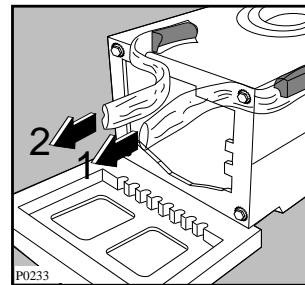
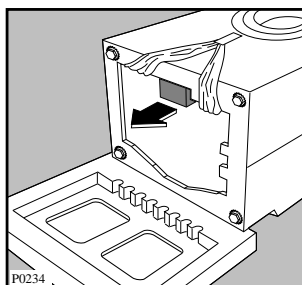
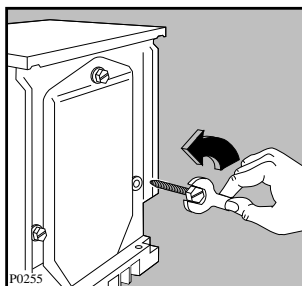

## Positioning

Install the machine on a flat hard floor. Make sure that air circulation around the machine is not impeded by carpets, rugs etc. Check that the machine does not touch the wall or other kitchen units. Carefully level by screwing the adjustable feet in or out. Never place cardboard, wood or similar materials under the machine to compensate for any unevenness in the floor. After having levelled the machine, tighten the lock nuts.

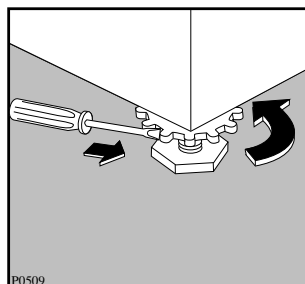
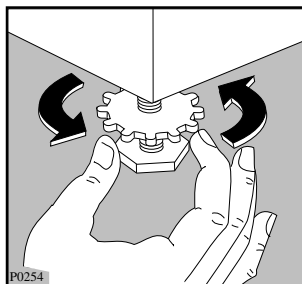

## Water inlet

Connect the water inlet hose to a tap with a 3/4" thread after having inserted the small filter "A" supplied with the machine.

The inlet hose must not be lengthened. If it is too short and you do not wish to move the tap, you will have to purchase a new, longer hose specially designed for this type of use.

The other end of the inlet hose which connects to the machine can be turned in any direction. Simply loosen the fitting, rotate the hose and retighten the fitting, making sure there are no water leaks.

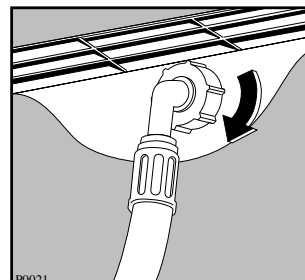
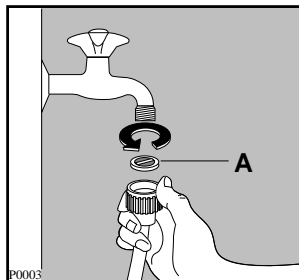

## Water drainage

The end of the drain hose can be positioned in three ways:

**Hooked over the edge of a sink using the plastic hose guide supplied with the machine.**

In this case, make sure the end cannot come unhooked when the machine is emptying. This could be done by tying it to the tap with a piece of string or attaching it to the wall.

**In a sink drain pipe branch.** This branch must be above the trap so that the bend is at least 60 cm above the ground.

**Directly into a drain pipe at a height** of not less than 60 cm and not more than 90 cm.

The end of the drain hose must always be **ventilated**, i.e. the inside diameter of the drain pipe must be larger than the outside diameter of the drain hose.

The drain hose must not be kinked. Run it along the floor; only the part near the drainage point must be raised.

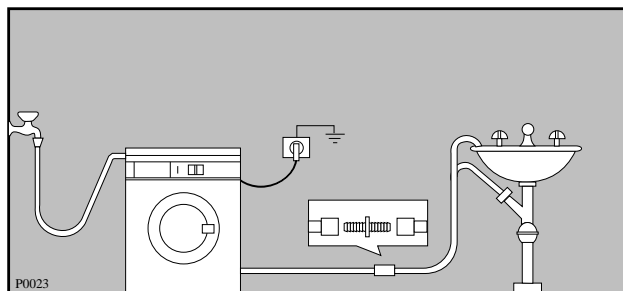
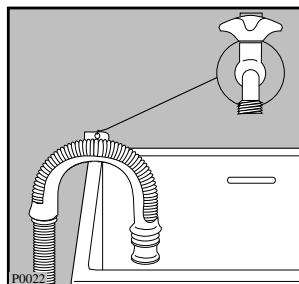

## Electrical connection

This machine is designed to operate on a 220-230 V, single-phase, 50 Hz supply.

Check that your domestic electrical installation can take the maximum load required (2.2 kW), also taking into account any other appliances in use.

**Connect the machine to an earthed socket.**



The manufacturer declines any responsibility for damage or injury through failure to comply with the above safety precaution.

## Door reversal

The opening direction of the outer door on this washing machine can be reversed. To carry out this operation, proceed as follows:

- 1) Disengage the end of the catch (1) from the door and turn it through 90° to remove it from its seat (Fig. A).
- 2) Using a screwdriver, turn plastic plug (2) through 90° to remove it from its seat (Fig. A).
- 3) Fit plug (2) in the hole left free by catch (1) and turn it through 90° to lock it in place (Fig. B).
- 4) Fit catch (1) into the hole from which plug (2) was removed and turn it through 90°, making sure that the latching tooth is facing towards the right (Fig. B).
- 5) Remove the door by unscrewing the screws securing it to the bottom hinge (3 - Fig. A).
- 6) Unscrew the two plastic screws (4 - Fig. A) and fit them on the opposite side (4 - Fig. B).
- 7) Remove the catch hook (5 - Fig. A) by inserting a screwdriver into the upper hole and pushing downwards.
- 8) Remove plate (6) by inserting a screwdriver into the bottom hole and pushing upwards (Fig. A).
- 9) Refit the catch hook (5) and plate (6) on the opposite sides (Fig. B).
- 10) Remove the door catch (7) and plate (8) as explained in paragraph 7.
- 11) Turn the door through 180°.
- 12) Refit the door catch (7) and plate (8), reversing their position and pressing firmly to engage the hook (Fig. B).
- 13) Fit the door onto the washing machine. Insert the top pin first, then the bottom pin into the hinge (3- Fig. B); finally screw the hinge onto the washing machine.
- 14) Check that the door is aligned with the appliance. To do this, loosen screw (9 - Fig. B) by a couple of turns and re-tighten when alignment is correct.
- 15) Fit the flexible end of the door catch (1 - Fig. B) into the location provided in the door.

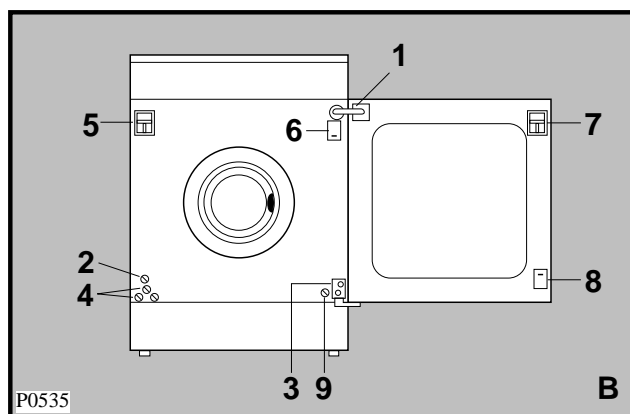
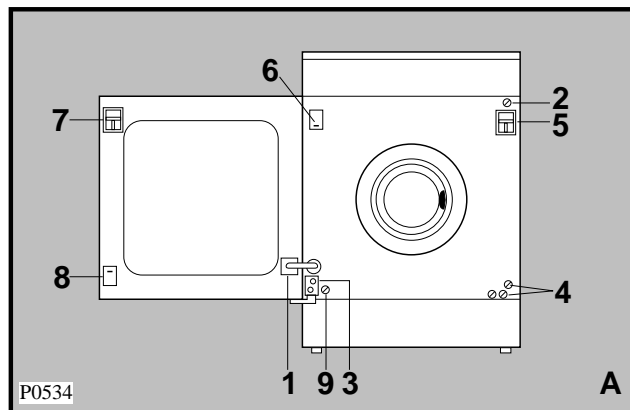

## Fitting a door panel

The door of this washing machine has mouldings to allow fitting of a decorative panel (stainless steel sheet, laminated plastic, wood etc.) to match with the existing kitchen units.

The dimensions of the panel must be as follows:

Width	588 mm
Height	588 mm
Maximum thickness	4 mm

To fit the panel, remove the moulding by unscrewing its fixing screws. Position the panel, then refit the moulding, making sure that it comes into contact with and firmly clamps the panel.



# USE

## Control panel

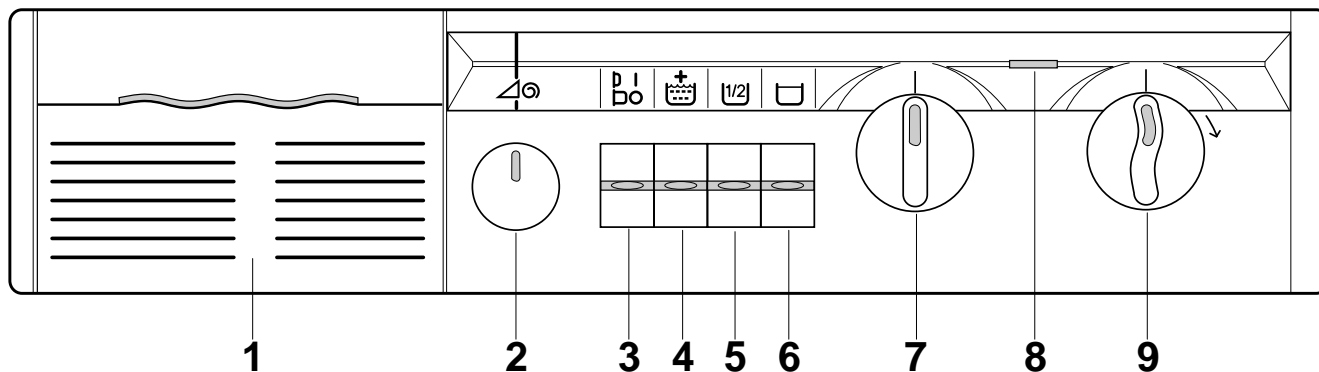

### 1 Programme chart

There is a programme guide in Spanish language on the handle of the detergent dispenser drawer.

### 2 Spin speed selector dial

This dial has the following positions:

- 1000 = MAX to 300 = MIN
-  = no spin

For linen and cotton items you can select a spin speed from 1000 to 300 rpm. For synthetics, delicates and wool from 550 (MAX) to 300 rpm (MIN). In the intermediate positions the machine will spin at decreasing speeds.

### 3 On/Off button

Press this button to start the machine: the «pilot» light will come on. The same button is used to switch the machine off.

**Before selecting a programme or changing an ongoing programme the machine must be switched off by depressing the same button.**

### 4 Intensive rinse button

By depressing this button on programmes for cotton and linen the machine will rinse with more water.

To be used in areas where the water is very soft or for people allergic to detergents or who have very delicate skin.

### 5 Half load button

Select this button to reduce water consumption on the rinse cycle when washing a smaller load of cottons or linens (max. load size=2.25 kg).

### 6 Rinse hold button

Press this button to make the machine stop with water in the drum after the synthetic or delicate wash cycles.

This prevents any creasing which may take place if the clothes are left damp in the drum. When it is convenient for you to empty the machine, simply press this button again so that the machine can proceed to drain and spin, or turn the dial to the drain programme "N".

### 7 Temperature selector dial

Turn this dial to select the washing temperature. Position  = cold wash.

### 8 Operating pilot light

This light is on whilst the machine is operating and goes out at the end of the programme.

### 9 Programme selector dial

To select the required programme, turn this dial **clockwise** until the programme letter is exactly opposite the pointer.

## **i** Washing hints

### Sorting the laundry

Follow the wash code symbols on each garment label and the manufacturer's washing instructions.

Sort the laundry as follows:

whites, coloureds, synthetics, delicates, woollens.

### Temperatures

**90°** for normally soiled white cottons and linen (e.g. tea cloths, towels, tablecloths, sheets...)

**60°** for normally soiled, colour fast garments (e.g. shirts, night dresses, pyjamas...) in linen, cotton or synthetic fibres and for lightly soiled white cotton (e.g. underwear).

**✕ (cold) 30°-40°** for delicate items (e.g. net curtains), mixed laundry including synthetic fibres and woollens bearing the label «pure new wool, machine washable, non-shrink»

### Before loading the laundry

Never wash whites and coloureds together. Whites may lose their "whiteness" in the wash.

New coloured items may run in the first wash; they should therefore be washed separately the first time.

**Make sure that no metal objects are left in the laundry (e.g. hair clips, safety pins, pins).**

Button up pillowcases, close zip fasteners, hooks and poppers. Tie any belts or long tapes.

Remove persistent stains before washing. Rub particularly soiled areas with a special detergent or detergent paste.

Treat curtains with special care. Remove hooks or tie them up in a bag or net.

### Maximum loads

Recommended loads are indicated in the programme charts.

General rules:

**cotton, linen:** drum full but not too tightly packed

**synthetics:** drum no more than half full

**delicate fabrics and woollens:** drum no more than one third full

Washing a maximum load makes the most efficient use of water and energy.

For heavily soiled laundry, reduce the load size.

### Laundry weights

The following weights are indicative:

bathrobe	1200 g
napkin	100 g
quilt cover	700 g
sheet	500 g
pillow case	200 g
tablecloth	250 g
towelling towel	200 g
tea cloth	100 g
night dress	200 g
ladies' briefs	100 g
man's work shirt	600 g
man's shirt	200 g
man's pyjamas	500 g
blouse	100 g
men's underpants	100 g

### Removing stains

Stubborn stains may not be removed by just water and detergent. It is therefore advisable to treat them prior to washing.

**Blood:** treat fresh stains with cold water. For dried stains, soak overnight in water with a special detergent then rub in the soap and water.

**Oil based paint:** moisten with benzine stain remover, lay the garment on a soft cloth and dab the stain; treat several times.

**Dried grease stains:** moisten with turpentine, lay the garment on a soft surface and dab the stain with the fingertips and a cotton cloth.

**Rust:** oxalic acid dissolved in hot water or a rust removing product used cold. Be careful with rust stains which are not recent since the cellulose structure will already have been damaged and the fabric tends to hole.

**Mould stains:** treat with bleach, rinse well (whites and fast coloureds only).

**Grass:** soap lightly and treat with bleach (whites and fast coloureds only).

**Ball point pen and glue:** moisten with acetone (\*), lay the garment on a soft cloth and dab the stain.

**Lipstick:** moisten with acetone as above, then treat stains with methylated spirits. Remove any residual marks from white fabrics with bleach.

**Red wine:** soak in water and detergent, rinse and treat with acetic or citric acid, then rinse. Treat any residual marks with bleach.

**Ink:** depending on the type of ink, moisten the fabric first with acetone (\*), then with acetic acid; treat any residual marks on white fabrics with bleach and then rinse thoroughly.

**Tar stains:** first treat with stain remover, methylated spirits or benzine, then rub with detergent paste.

**(\*) do not use acetone on artificial silk**

## Detergents and additives

Good washing results also depend on the choice of detergent and use of the correct quantities to avoid waste and protect the environment. Although biodegradable, detergents contain substances which, in large quantities, can upset the delicate balance of nature.

The choice of detergent will depend on the type of fabric (delicates, woollens, cottons, etc.), the colour, washing temperature and degree of soiling.

All commonly available washing machine detergents may be used in this appliance:

- powder detergents for all types of fabric,
- powder detergents for delicate fabrics (60°C max) and woollens,
- liquid detergents, preferably for low temperature wash programmes (60°C max) for all types of fabric, or special for woollens only.

The detergent and any additives must be placed in the appropriate compartments of the dispenser drawer before starting the wash programme.

If using concentrated powder or liquid detergents, a programme **without** prewash must be selected.

Pour liquid detergent into the dispenser drawer compartment marked  **just before** starting the programme.

Any fabric softener or starching additives must be poured into the compartment marked  before starting the wash programme.

The bleaching agent (chlorine) can be used only for white or fast coloured cotton and linen items. Pour it into the compartment marked .

Follow the product manufacturer's recommendations on quantities to use.

## Quantity of detergent to be used

The type and quantity of detergent will depend on the type of fabric, load size, degree of soiling and hardness of the water used.

Water hardness is classified in so-called "degrees" of hardness. Information on hardness of the water in your area can be obtained from the relevant water supply company, or from your local authority.

Follow the product manufacturers' instructions on quantities to use.

Use less detergent if:













- you are washing a small load
- the laundry is lightly soiled
- large amounts of foam form during washing.



## Degrees of water hardness





Level	Characteristic	Degrees	
		German °dH	French °T.H.
1	soft	0- 7	0-15
2	medium	8-14	16-25
3	hard	15-21	26-37
4	very hard	more than 21	more than 37





## **i** Wash code symbols







These symbols appear on fabric labels, in order to help you choose the best way to treat your laundry.

<b>Energetic wash</b>   <b>Delicate wash</b>	 Max. wash temperature 95°C	 Max. wash temperature 60°C	 Max. wash temperature 40°C	 Max. wash temperature 30°C	 Hand wash	 Do not wash at all
	   					

 <b>Bleaching</b>	 Bleach in cold water	 Do not bleach
---	---	--











 <b>Ironing</b>	 Hot iron max 200°C	 Warm iron max 150°C	 Lukewarm iron max 110°C	 Do not iron
---	---	--	--	--

 <b>Dry cleaning</b>	 Dry cleaning in all solvents	 Dry cleaning in perchlorethylene, petrol, pure alcohol, R 111 & R 113	 Dry cleaning in petrol, pure alcohol and R 113	 Do not dry clean
--	---	--	---	---

 <b>Drying</b>	 Flat	 On the line	 On clothes hanger	 high temperature  low temperature Tumble dry	 Do not tumble dry
--	---	--	--	---	--

## Energetic programmes for cotton and linen

Maximum load: 4.5 kg







Progr.	Temp.	Type of laundry	Cycle description	Possible options
<b>A</b>	<b>60°-90°</b>	Whites with prewash (heavily soiled)	Prewash Wash at 60°-90°C Rinses Spin	 
<b>B(•)</b>	<b>60°-90°</b>	Whites without prewash (normally soiled)	Wash at 60°-90°C Rinses Spin	 
<b>B</b>	<b>40°-60°</b>	Fast coloureds without prewash (normally soiled)	Wash at 40°-60°C Rinses Spin	 
<b>C</b>	<b>30°-40°</b>	No fast coloureds (normally soiled)	Wash at 30°-40°C Rinses Spin	 
<b>D</b>		Rinses/Bleaching	Rinses with liquid additives, if required Spin	 
<b>F</b>		Spin	Drain and spin	

The temperatures indicated are the optimum temperatures for each programme and depend on the type of laundry and degree of soiling.

(•) This programme at 60°C is the reference programme for the Energy label according to the EEC Directive 92/75.

## Gentle programmes for synthetics, mixed fibres, delicates and woollens

Maximum load: 2 kg, woollens: 1kg

Progr.	Temp.	Type of laundry	Cycle description	Possible option
<b>G</b>	40°-60°	Synthetics with prewash (heavy soiled)	Prewash Wash at 40°-60°C Rinses Short spin	
<b>H</b>	40°-60°	Synthetics without prewash (normally soiled)	Wash at 40°-60°C Rinses Short spin	
<b>J</b>	30°-40°	Delicate fabrics - Silk	Wash at 30°-40°C Rinses Short spin	
<b>K</b>	40°	Woollens 	Wash at 40°C Rinses Short spin	
<b>L</b>		Rinses	Rinses with fabric softener Short spin	
<b>M</b>		Short spin		
<b>N</b>		Drain		

The temperatures indicated are the optimum temperatures for each programme and depend on the type of laundry and degree of soiling.

## Operating sequence



Before washing your first load of laundry, we recommend that you run a cotton cycle at 60°C, **with the machine empty**, in order to remove any manufacturing residue from the drum and tub. Pour half a measure of detergent into the main wash compartment and start up the machine.

### 1. Place the laundry in the drum

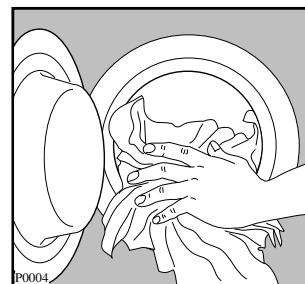
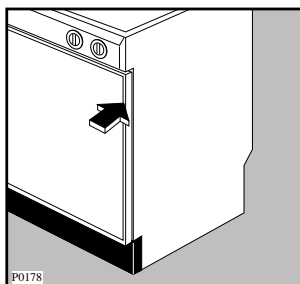
Open the door.  
Place the laundry in the drum, one item at a time, shaking them out as much as possible.  
Close the door.



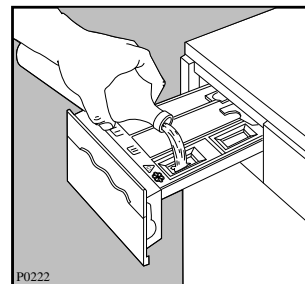
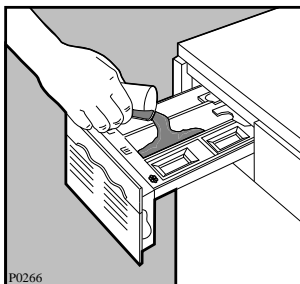

### 2. Measure out the detergent

Pull out the dispenser drawer until it stops.  
Measure out the amount of detergent recommended by the manufacturer in a graduated cup and pour it into the main wash compartment . If you wish to carry out a prewash, pour detergent into the appropriate compartment marked .



### 3. Measure out the additives

If required, pour fabric softener into the compartment marked  and the bleaching agent into the compartment marked  without exceeding the «MAX» mark.

### 4. Select the desired option(s) and the spin speed

### 5. Select the temperature

Turn the selector dial to the required temperature setting.

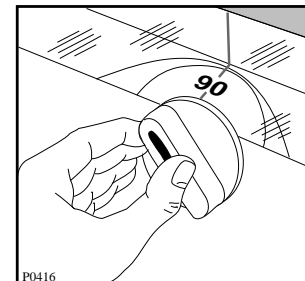
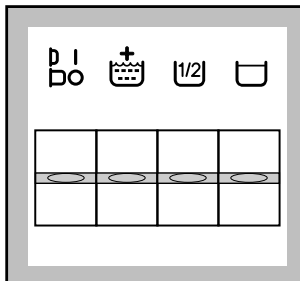

## 6. Select the programme and start it

Turn the programme selector dial clockwise to the required wash programme and press the start/stop button  $\text{P}_{\text{Do}}$ : the operating pilot light comes on and the machine starts to operate.

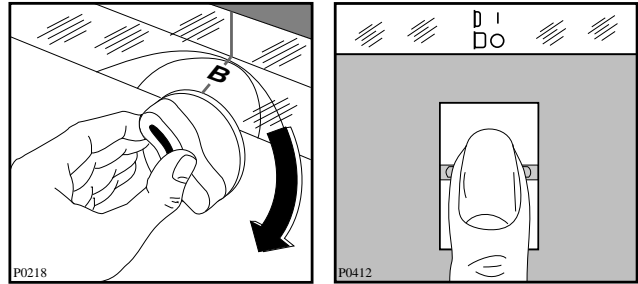

## 7. At the end of the programme

The machine stops automatically, the operating pilot light goes out.

If you have selected a gentle programme with the anticrease option , drain the water before opening the door.

It is normal to have to wait for about 2 minutes before being able to open the door to allow the safety lock to release.

Press the start/stop button again.

Remove the laundry.

Turn the drum by hand to make sure it is completely empty, so as to avoid any forgotten items being damaged in a subsequent wash (e.g. shrinking) or their colour running into a load of whites.

Release any buttons which have been pressed.

Turn the water tap off and unplug the machine.

Leave the door ajar to air the machine.



# MAINTENANCE

## 1. Bodywork

Clean the outside of the machine with warm water and a neutral, non-abrasive household detergent. Rinse with clean water and dry with a soft cloth.

**Important:** do not use methylated spirits, solvents or similar products to clean the bodywork.

## 2. Detergent dispenser drawer

After a while, detergents and fabric softeners leave deposits in the drawer.

Clean the drawer from time to time by rinsing it under a running tap. To remove the drawer from the machine, press the button in the rear left-hand corner.

To facilitate cleaning, the top part of the additive compartments can be removed.

Detergent can also eventually accumulate inside the drawer recess: clean it with an old toothbrush. Refit the drawer after cleaning.

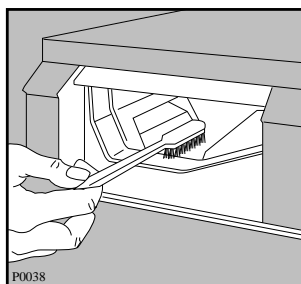
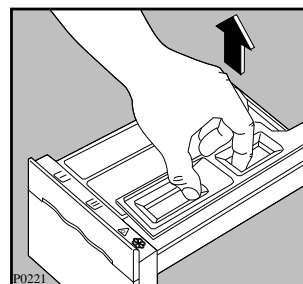
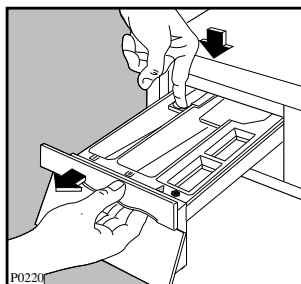

## 3. Water inlet filter

If you notice that the machine is taking longer to fill, check that the filter in the water inlet hose is not blocked.

Turn off the water tap.

Unscrew the hose from the tap and remove the filter.

Clean it with a stiff brush.

Refit the filter and screw the hose back onto the tap.

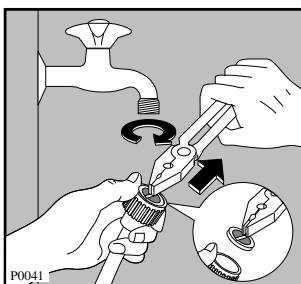

## 4. Drain filter

The drain filter collects threads and small objects inadvertently left in the laundry. Check regularly that the filter is clean.

Open the door of the machine.

Place a container under the filter and unscrew it.

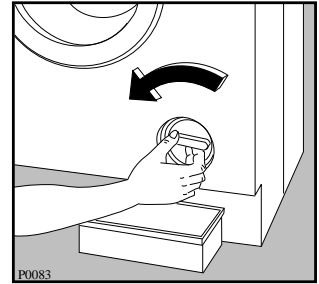
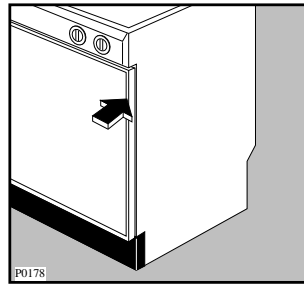

Pull out the filter.

Clean the filter under a running tap, then refit it, screwing it fully in.

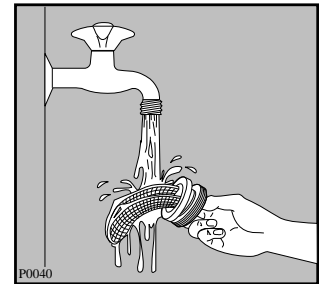
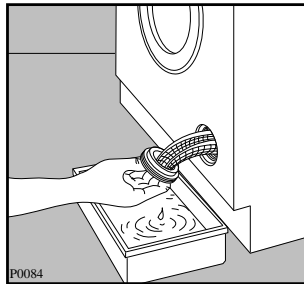

## 5. The dangers of freezing

If the machine is exposed to temperatures below 0°C, certain precautions should be taken.

- Turn off the water tap.
- Unscrew the inlet hose.
- Unhook the drain hose from the rear support and position the end of this hose and that of the inlet hose in a bowl. Run the draining programme until the selector dial is in the "Stop" position.
- Disconnect the appliance.
- Screw the inlet hose and reposition the drain hose.
- When you intend to start the machine up again, make sure that the room temperature is above 0°C.

## SOMETHING NOT WORKING

*Problems which you can resolve yourself*

<b>■ Problem</b>	<b>Possible cause</b>
<b>■ The machine does not start up:</b>	<ul style="list-style-type: none"> <li>■ Check that the door is firmly closed.</li> <li>■ Check that the machine is plugged in and that there is power at the socket.</li> <li>■ Check that the main fuse has not blown.</li> <li>■ Check that the programme selector dial is positioned correctly and that the start/stop button has been depressed.</li> </ul>
<b>■ The machine does not fill:</b>	<ul style="list-style-type: none"> <li>■ Check that the water tap is open.</li> <li>■ Check that water is coming out of the tap.</li> <li>■ Check that the inlet hose is not squashed or kinked.</li> <li>■ Check that the filter in the inlet hose is not blocked.</li> <li>■ Check that the door is closed.</li> </ul>
<b>■ The machine fills then empties immediately</b>	<ul style="list-style-type: none"> <li>■ The end of the drain hose is too low. Refer to relevant paragraph in "water drainage" section.</li> </ul>
<b>■ The machine does not empty and/or does not spin:</b>	<ul style="list-style-type: none"> <li>■ Check that the drain hose is not squashed or kinked.</li> <li>■ The drain filter is blocked. Clean it.</li> <li>■ The anticrease or no spin option has been selected.</li> <li>■ The wash load is unbalanced. Redistribute the clothes inside the drum to allow the machine to spin.</li> </ul>
<b>■ There is water on the floor:</b>	<ul style="list-style-type: none"> <li>■ Too much detergent or unsuitable detergent (creates too much foam) has been used.</li> <li>■ Check whether there are any leaks from one of the inlet hose fittings. It is not always easy to see this as the water runs down the hose; check to see if it is damp.</li> <li>■ Check that the drain hose is not damaged.</li> <li>■ Check that the drain filter has been refitted correctly after cleaning.</li> </ul>
<b>■ Unsatisfactory washing results</b>	<ul style="list-style-type: none"> <li>■ Too little detergent or unsuitable detergent has been used.</li> <li>■ Stubborn stains have not been treated prior to washing.</li> <li>■ The correct temperature or programme was not selected.</li> </ul>

■ Problem	Possible cause
■ The machine vibrates or is noisy:	<ul style="list-style-type: none"> <li>■ Check that all the transit bolts and packing have been removed.</li> <li>■ Check that the machine is not resting against anything.</li> <li>■ Check that the support feet are resting firmly on the ground and that the lock nuts are securely tightened.</li> <li>■ Check that the laundry is evenly distributed in the drum.</li> <li>■ Maybe there is very little laundry in the drum.</li> </ul>
■ The door will not open:	<ul style="list-style-type: none"> <li>■ The programme is still running.</li> <li>■ The door lock has not yet been released.</li> </ul>

If you are unable to identify or solve the problem, contact our service centre. Before telephoning, make a note of the model, serial number and purchase date of your machine: the Service Centre will require this information.

