

Models LA7000XK;  
Super Capacity

# Whirlpool AUTOMATIC WASHER

## Use & Care Guide

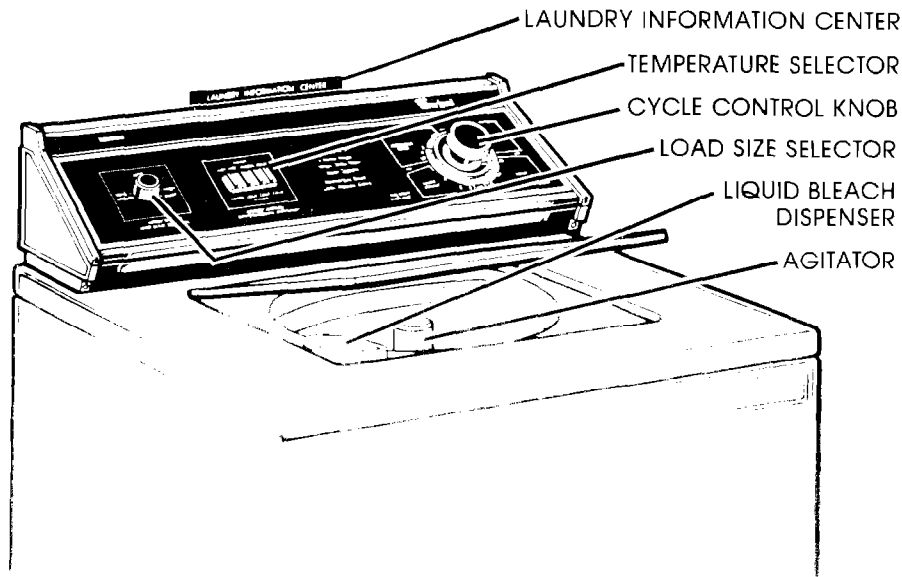

### Copy Your Model and Serial Numbers Here

When you need service, or call with a question, have this information ready:

1. **Complete** Model and Serial Numbers (from the plate under the lid near the hinge).
2. Purchase date from sales slip (or date installed).

Copy this information in these spaces. Keep this book in the Laundry Information Center with your *Laundry Guide*, sales slip and warranty.

Model Number \_\_\_\_\_

Serial Number \_\_\_\_\_

Purchase Date \_\_\_\_\_

Installation Date \_\_\_\_\_

# Before using your Washer

Please read this booklet to be sure your washer is installed and used properly. It will help you get the best results and longest life your washer was designed to give.

**You are personally responsible for making sure that your washer...**

- is installed by a qualified installer.
- is properly installed and leveled on a floor that can support the weight.
- is connected to the right kind of outlet, electric supply, water supply and drain.
- is properly electrically grounded.
- is used only for loads normally expected of home automatic washers.
- is properly maintained.
- is protected from the weather.
- is not run by children or anyone unable to operate it properly.

**Remove** the Consumer Buy Guide label. It will be easier to remove before the washer is used.

You may want to wipe out the basket with a damp cloth before using to remove dust from storing or shipping.

**SPECIAL INSTRUCTIONS: See the Laundry Guide for tips on detergents, other laundry aids and instructions for washing special items.**

See the Installation Instructions for complete information.

## SAFETY FIRST

Do not permit children to operate or play with the washer.

**CAUTION:** Store laundry detergent and additives in a cool, dry place where children can't reach them.

## SPINNING SAFETY

If the lid is opened while the basket is spinning, the basket will automatically stop in a few seconds. **DO NOT ADD OR REMOVE ITEMS UNTIL THE BASKET STOPS COMPLETELY.**

## SPECIAL CAUTION

Flammable gases may build up in hot water pipes and heater. This can happen when hot water hasn't been used for a while (usually two weeks or more).

To prevent injury or damage, allow any gases to escape by running hot water from the faucet nearest the washer for several minutes. Don't smoke near the faucet while it is open, and turn off any open flame.

## Contents

|                                 |    |
|---------------------------------|----|
| Before Using Your Washer        | 2  |
| Loading Your Washer             | 3  |
| MAGIC CLEAN® Lint Filter        | 3  |
| Using Your Washer               | 4  |
| Water Levels and Load Sizes     | 5  |
| Liquid Bleach Dispenser         | 5  |
| Important Detergent Information | 6  |
| For Rinsing Only                | 7  |
| For Spinning Only               | 7  |
| Cycle Operation                 | 8  |
| PERMANENT PRESS                 | 8  |
| KNITS GENTLE                    | 8  |
| REGULAR HEAVY                   | 8  |
| SOAK CYCLE                      | 10 |
| SUPER WASH                      | 10 |
| For a Pre Wash                  | 10 |
| If You Need Service or Help     | 10 |
| 1. Before Calling for Service   | 10 |
| 2. If You Need Service          | 12 |
| 3. If You Have a Problem        | 12 |

## Loading your Washer



For best washing results and energy savings, sort the laundry carefully.

### 1. Sort the Laundry into Loads.

- Group the laundry into loads that can be washed and dried together. See the Laundry Guide for information and samples of typical loads.
- Try to mix large and small items for best movement in the washer.

### 2. Measure Detergent; Add to Washer Basket.

- See detergent information on page 6 and in Section IV of the Laundry Guide.

### 3. Load the Washer.

- Load without packing so items can move freely for best cleaning and least wrinkling.
- Spread the load evenly. (Don't put all the towels on one side and a few wash cloths on the other.) An unbalanced load can cause the washer to shake during spinning.

### 4. Pour Liquid Bleach into the Dispenser.

- See page 5 and the "Laundry Aids" section of the Laundry Guide for more information.

### 5. Add Diluted Fabric Softener only to the Deep Rinse Cycle.

- **DO NOT ADD FABRIC SOFTENER TO THE WASH.** Fabric softeners can combine with soap or detergent to make greasy stains on fabrics.

## MAGIC CLEAN® Lint Filter

The lint filter is self-cleaning. It filters water used in both the wash and the rinse. When the washer drains, lint collected is flushed away.

If your washer drains into a tub, watch the drain strainer for the lint. A linty load can plug the tub drain and cause an overflow.

# Using your Washer

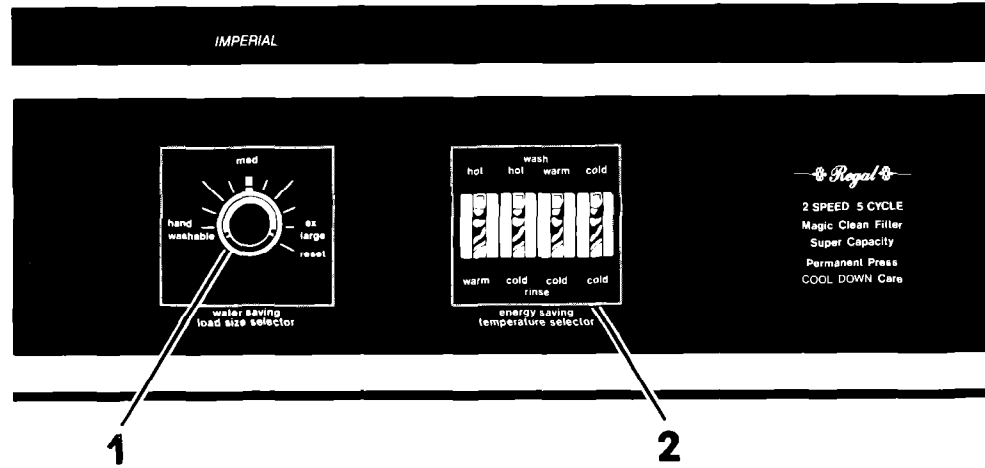

Start your washer after you put in detergent, the load, and any other laundry aids according to information on page 3 and page 6.

## 1. Set the LOAD SIZE SELECTOR.

- Select the water level that matches the size of the load. See page 5 for more information.
- To change the setting on the **LOAD SIZE SELECTOR**, first move it to RESET. Then move it back to the setting you want.

**IMPORTANT:** For the best cleaning results with the least wrinkling, make sure the load has enough water for items to move freely.

## 2. Set the TEMPERATURE SELECTOR.

- Match the wash and rinse water temperatures to the type of fabrics and soils being washed. (See the instructions under the washer lid and on page 14 in your *Laundry Guide*.)
- Be sure to use a cold rinse for PERMANENT PRESS and KNITS GENTLE Cycles.

**Cold water rinses save energy and help prevent wrinkles from setting into fabrics.**

## 3. Select a Cycle and Start the Washer.

- Push the Cycle Control Knob in and turn it to the right (clockwise).
- Stop when the pointer is on the number of minutes of washing you want in the cycle you want.
- Instructions for which cycles to use for each fabric type are under the lid.
- To start the washer, pull the Cycle Control Knob out. When the cycle is over, the washer will stop.
- **To stop the washer at any time during a cycle, push the Control Knob in.** Pull it out to restart the washer.
- **To change a setting,** push the Control Knob in to stop the washer. Then turn the Control Knob to the right (clockwise) to the setting you want. Pull the knob out to start the washer.
- Pages 8-11 show what happens in each cycle.



## Important Detergent Information

Detergents and soaps clean by loosening soil, and by holding it in the water so it drains away. If not enough detergent is used, soil and lint can settle back on the items in the load.

**SOAP** works best in *soft water* (0-4 grains hardness). In harder water, both the wash and rinse water should be softened. Use enough soap to make about 1½ to 2 inches (3.8 to 5.5 cm) of suds.

**DETERGENT** works in *hard or soft water*. Package directions are usually based on soft water and

washers with normal-size tubs. **Use more detergent...**

1. for hard water.
2. for loads and water levels larger than MEDIUM.
3. for heavy greasy or oily soils.
4. if the detergent is low phosphate.
5. for cold-water washes.

**DETERGENT SUDS.** There are high, normal and low sudsing powdered detergents. If the recommended amount of detergent makes too much suds, switch to a lower sudsing brand. **DO NOT REDUCE THE AMOUNT** of detergent.

Use the following chart as beginning suggestions for powdered and liquid detergent amounts. **See your Laundry Guide for more information (pages 14-22).**

### RECOMMENDED AMOUNT OF DETERGENT\* – FULL TUB

|                     | WATER HARDNESS IN GRAINS  |                  |                        |
|---------------------|---|------------------|------------------------|
|                     | 0-4 Grains  | 4-10 Grains      | 10-20 Grains           |
| Powdered Detergents |   |                  |                        |
| Low Suds            | 1¼ cups (300 mL)  | 1½ cups (350 mL) | 1¾-2 cups (425-475 mL) |
| Normal Suds         | 1¾ cups (425 mL)  | 2½ cups (600 mL) | 3 cups (700 mL)        |
| High Suds           | 2 cups (475 mL)   | 3 cups (700 mL)  | 3½ cups (825 mL)       |
| No phosphate        | – Follow package recommendations –  |                  |                        |
| Liquid Detergents   | 1/3 to 1½ cups (80 to 325 mL), depending on the brand and amount of soil. Follow package recommendations. |                  |                        |

\* These recommendations do not apply...

- In areas where phosphates are banned.
- In areas with laws limiting (by weight or percentage) the amount of detergent used in a wash load.

## For Rinsing Only

Your washer can be set to rinse only. Use the setting for an extra rinse, or for laundry that only needs a rinse and spin.

There is a dot just after the numbers in PERMANENT PRESS, REGULAR HEAVY and KNITS GENTLE. If you push in on the Cycle Control knob, turn the pointer to one of those dots and pull the Control Knob out, the washer will fill, agitate, drain and spin.

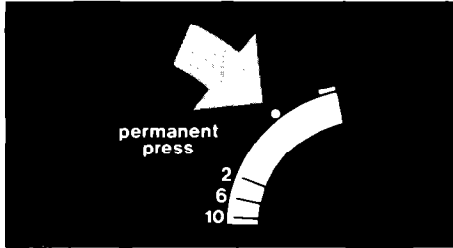

If you want high agitation and spin, use the dot in REGULAR HEAVY. If you want low agitation and spin, use the dot in KNITS GENTLE. Use the dot in PERMANENT PRESS if you want high agitation and a low-speed spin.

## For Spinning Only

There may be times when you want to drain out all the wash water and start over. To stop the washer at any time, just push in on the Cycle Control knob.

To set the washer so it drains and spins water out of the load, push in on the Control Knob, turn the dial to the right (clockwise) so the pointer is touching the bar just before OFF in any cycle.

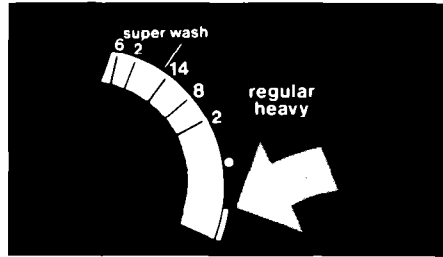

The washer will drain, spin out water and stop. If you want a low-speed spin, use the bar on PERMANENT PRESS or KNITS GENTLE. All the other cycle settings have a high-speed spin.

# Cycle Operation

Your washer has five cycles on the Cycle Control Dial. Each cycle is designed to match the fabric type with pre-set agitation and spin speeds.

The numbers in each cycle are for the number of minutes you want the washer to agitate before it drains and fills for the rinse. You will want longer agitation times for heavily soiled loads. You choose the wash and rinse

## WHAT HAPPENS IN EACH CYCLE:

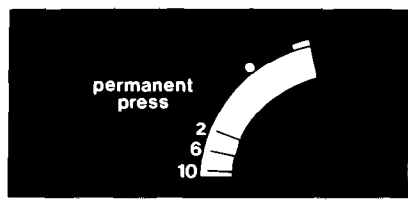

**permanent press**

- SET LOAD SIZE
- SET WATER TEMPERATURES
- PUSH IN KNOB, TURN TO CYCLE AND TIME
- PULL OUT TO START

### PERMANENT PRESS CYCLE

Use for permanent press fabrics. Cooling of the wash water and low spin speeds help prevent the setting of wrinkles.

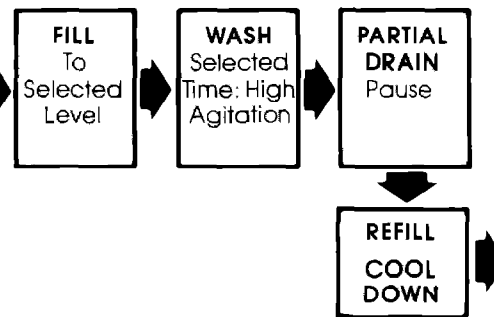
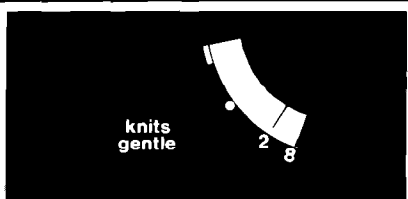



**knits gentle**

- SET LOAD SIZE
- SET WATER TEMPERATURES
- PUSH IN KNOB, TURN TO CYCLE AND TIME
- PULL OUT TO START

### KNITS GENTLE CYCLE

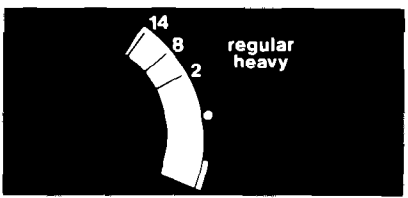
Use for delicate items and washable synthetic knits such as polyester, nylon, acrylic. Wash nylon hose or panty hose in a net laundry bag.

**regular heavy**

- SET LOAD SIZE
- SET WATER TEMPERATURES
- PUSH IN KNOB, TURN TO CYCLE AND TIME
- PULL OUT TO START

### REGULAR HEAVY CYCLE

Use for sturdy white and colorfast cottons, and for heavy work clothes. High agitation and spin speeds are pre-set for best cleaning results.





water temperatures you want with the **TEMPERATURE SELECTOR**.

You set the amount of water that fills the tub with the **LOAD SIZE SELECTOR**.

**NOTE:** You may notice that some of the **SPIN** cycles have **SPRAY RINSES**. Cold water is sprayed on the spinning load to help rinse and remove detergent residue.

*If you turn to a cycle and start the washer but change your mind, push in on the Cycle Control Knob and turn to the right (clockwise) to the setting you want. Then pull out to start.*

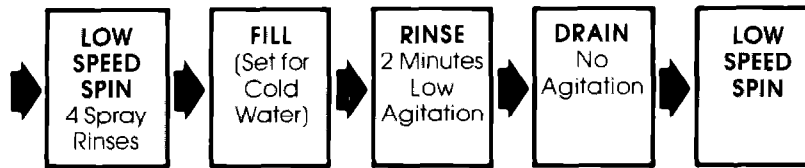
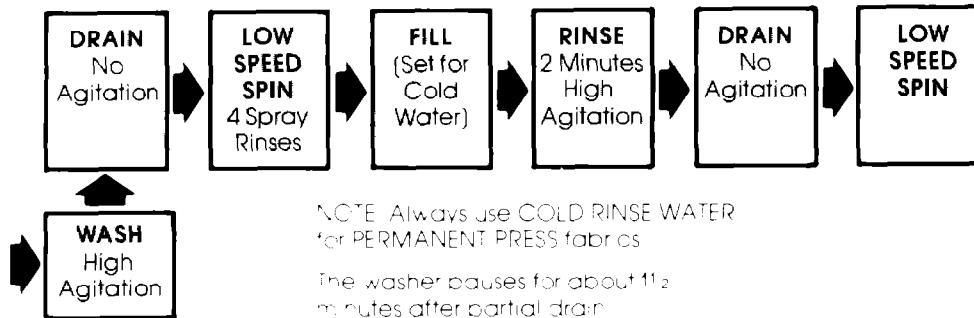

**NOTE:** Always use COLD RINSE WATER for Knits and Delicate items.

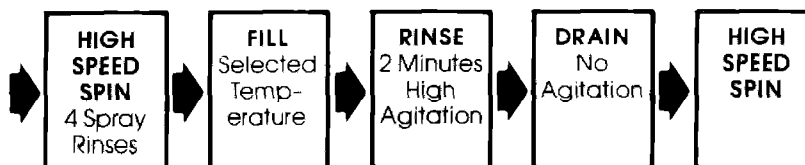

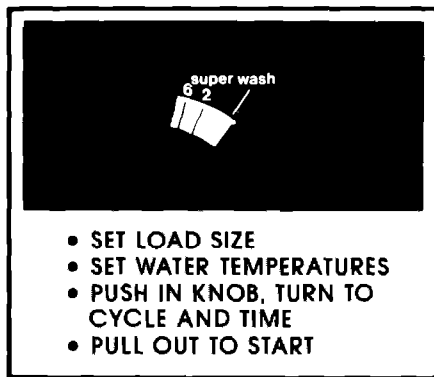

## SUPER WASH CYCLE

Use as a double wash for heavily soiled loads. Use enough detergent for two washes. (SUPER WASH and REGULAR HEAVY.)

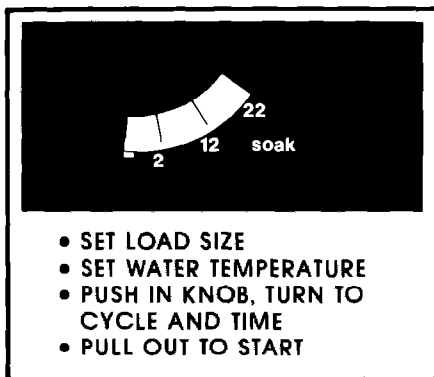

## SOAK CYCLE

This cycle is not for washing, it soaks, agitates, spins out the water and stops (no rinse). Use it for stained, yellowed, grey or heavily soiled laundry with a detergent or pre-soak product. Chlorine bleach, if wanted, should be added to the cycle you use after the SOAK Cycle is over.



## For a Pre Wash

Use this setting for a shorter SOAK CYCLE (no rinse). Use enough detergent for a single wash. Add the load.

- Set the **LOAD SIZE SELECTOR**.
- Set wash water temperature.

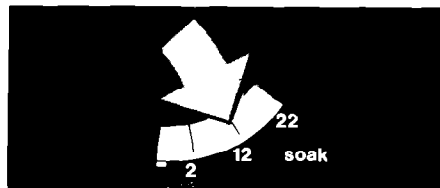

- Push the Cycle Control Knob in and turn it to the 12 minute mark in the SOAK CYCLE.
- Pull the Control Knob out to start the washer.
- The washer will fill, agitate for two minutes, soak for eight minutes, agitate for two more, drain, drain and spin. (see SOAK CYCLE description on page 10.)
- After filling, the washer may pause before starting to agitate.

## If You Need Service or Help, We suggest You Follow These Three Steps:

### 1. Before calling for service\*...

Problems are sometimes caused by little things you can correct without tools. Check this list before you call for service.

#### IF YOUR WASHER DOES NOT FILL:

- Is the power supply cord plugged in?

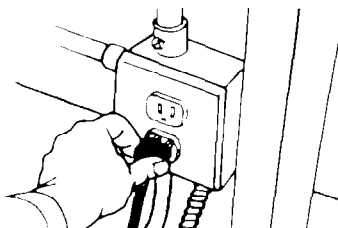

**\* Dissolve enzyme pre-soak and detergent powders to help prevent spot fading on colored items. If you use chlorine bleach, it MUST be diluted with a quart of warm water and added after the washer fills. Do not use bleach dispenser. See *Laundry Guide* for more information.**



The washer will go on with the PERMANENT PRESS cycle if you want a different cycle to follow SUPER WASH. Turn the Cycle Control knob to the cycle and time you want, push it in

**\* Dissolve enzyme pre-soak and detergent powders to help prevent spot fading on colored items. If you use chlorine bleach, it MUST be diluted with a quart of warm water and added after the washer fills. Do not use bleach dispenser. See *Laundry Guide* for more information.**

Before adding detergent for washing, dissolve in a quart of warm water (or use liquid detergent).

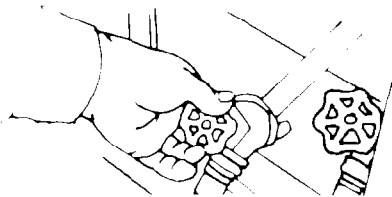
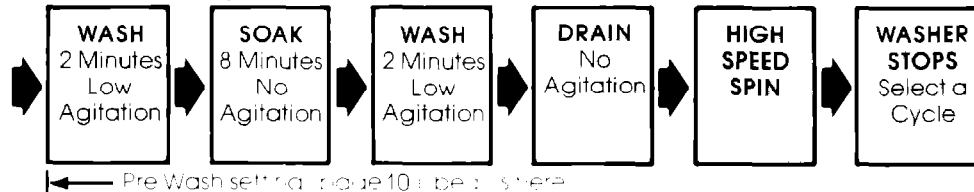

- Are both water faucets open?
- Is a fuse blown or circuit breaker tripped?
- Are the water supply hoses kinked?
- Is the Cycle Control Knob set and pulled out?

**IF YOUR WASHER DOES NOT SPIN:**

- Is the lid closed?
- Is the power supply cord plugged in?
- Is a fuse blown or circuit-breaker tripped?

**IF WASHER FILLS AND DRAINS WITHOUT RUNNING:**

- Make sure that the Cycle Control Knob is pointing to a number in the cycle.

**IF YOUR WASHER STOPS DURING THE PERMANENT PRESS CYCLE.**

- Remember, the washer will stop for about 1 1/2 minutes after the partial drain during the cool-down period in this cycle.

**MAKE SURE THE DRAIN HOSE IS HIGHER THAN THE WATER LEVEL IN THE WASHER. IF IT ISN'T...**

- The washer may seem to be draining during wash and rinse cycles.
- Water can siphon out. (See Installation Instructions.)

CYCLE OPERATION/PRE WASH / BEFORE CALLING FOR SERVICE

## 2. If you need service :



If your WHIRLPOOL® appliance ever needs service anywhere in the United States, help is just a phone call away... to your nearest Whirlpool franchised TECH-CARE® service representative.

Whirlpool maintains a nationwide network of franchised TECH-CARE service companies to fulfill your warranty and provide after-warranty service and maintenance to keep your WHIRLPOOL appliance in peak condition.

You'll find your nearest TECH-CARE service company listed in your local telephone book Yellow Pages under APPLIANCES — HOUSEHOLD — MAJOR — SERVICE & REPAIR. **Should you not find a listing, dial the Whirlpool COOL-LINE® service assistance toll-free telephone number:**

**Continental**

**U.S. .... Dial (800) 253-1301**

**In Michigan ... Dial (800) 632-2243**

**Alaska and**

**Hawaii ..... Dial (800) 253-1121**

**If you move...** To make sure that your appliance is correctly installed and to insure its continued satisfactory operation, please telephone your nearest TECH-CARE® service company for installation or to get the name of a

qualified installer. (Installation cost will, of course, be paid by you.)

**Helpful hints...** You can help your TECH-CARE service representative give you faster service if you include the model and serial number of your appliance when requesting service. Also, retain your sales slip and warranty to verify your warranty status.

**Remember...** Your TECH-CARE service representative is specially trained in the expert repairing and servicing of your WHIRLPOOL appliances. He can help you maintain the quality originally built into your WHIRLPOOL appliance. So why not take the time, now, to look up his telephone number and jot it down in the space provided on the cover.

## 3. If you have a problem :

Call Whirlpool Corporation in Benton Harbor at the COOL-LINE service assistance telephone number (see Step 2) or write:

Mr. Guy Turner, Vice President  
Whirlpool Corporation  
Administrative Center  
2000 U.S. 33 North  
Benton Harbor, Michigan 49022

If you must call or write, please provide: your name, address, telephone number, type of appliance, brand, model, serial number, date of purchase, the dealer's name, and a complete description of the problem. This information is needed in order to better respond to your request for assistance.



FSP is a registered trademark of Whirlpool Corporation for quality parts. Look for this symbol of quality whenever you need a replacement part for your Whirlpool appliance. FSP replacement parts

will fit right and work right because they are made to the same exacting specifications used to build every new Whirlpool appliance.



Benton Harbor, Michigan. Automatic Washers. Clothes Dryers. Freezers. Refrigerator-Freezers. Ice Makers. Dishwashers. Built-in Ovens and Surface Units. Ranges. Microwave Ovens. Compactors. Room Air Conditioners. Dehumidifiers. Central Heating and Air Conditioning Systems.

Quality. Our way of life.