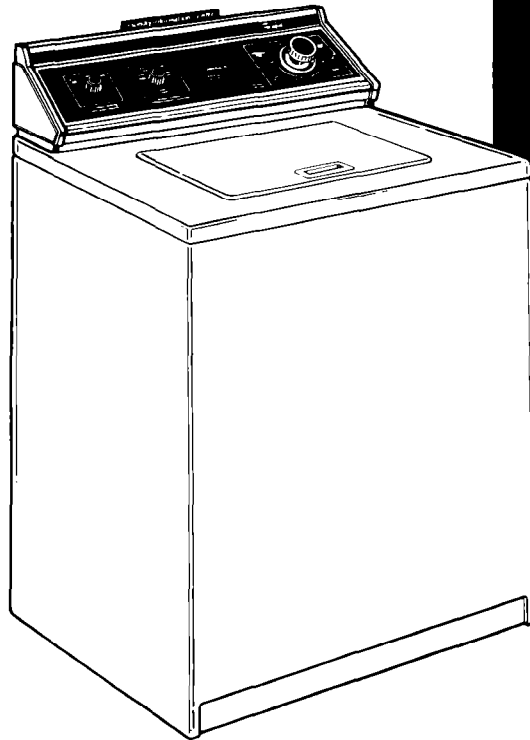
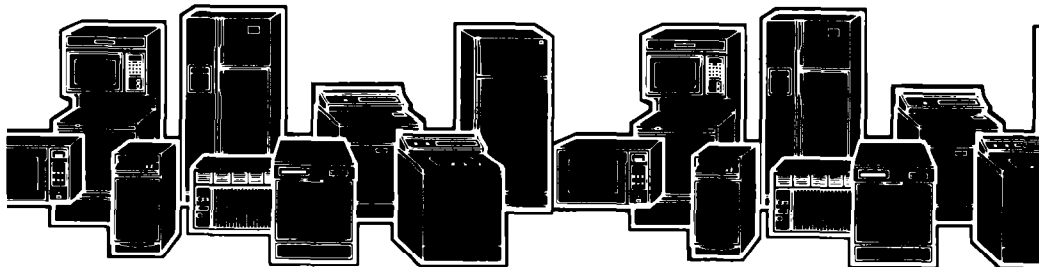

use & care guide

The Whirlpool logo, consisting of a stylized swirl above the word "Whirlpool" in a serif font, all set against a black rectangular background.

AUTOMATIC WASHER

**Large Capacity
Models
LA5700XM
and
LA5705XM**

Wave Ovens, Trash Compactors, Room Air Conditioners, Dehumidifiers, Automatic Washers, Clothes Dryers, Freezers, Refrigerator-Freezers



Parts and features

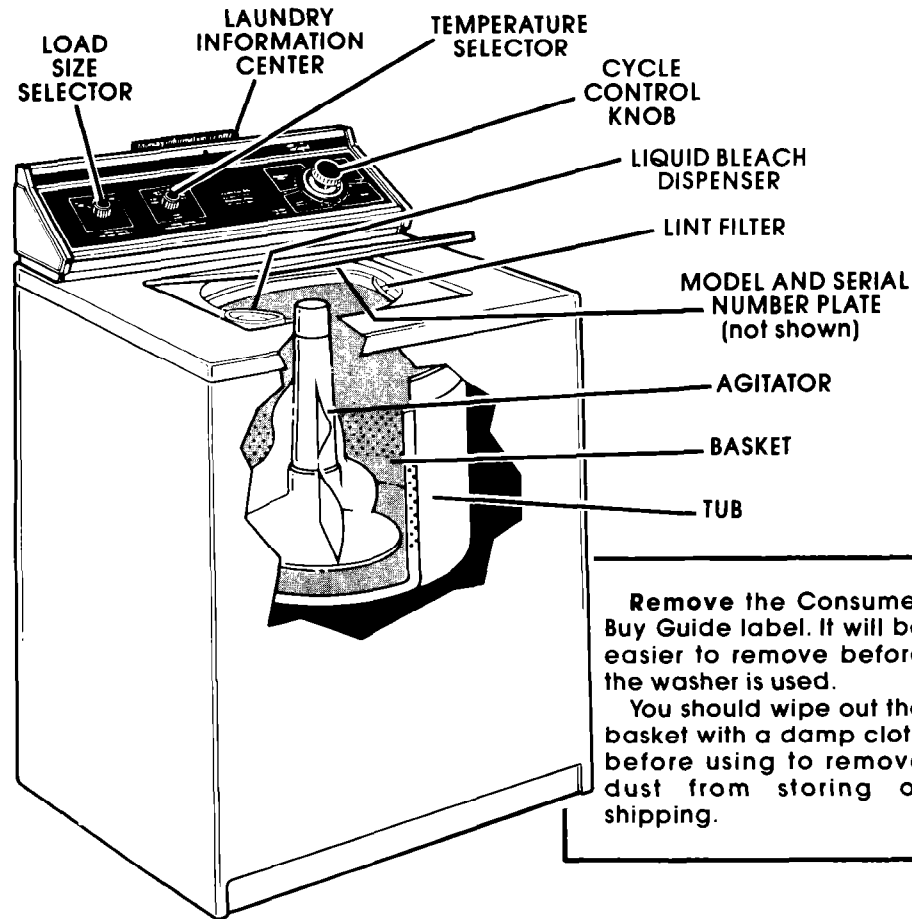

Copy your Model and Serial Numbers here

When you need service or call with a question, have this information ready:

1. **Complete Model and Serial Numbers** (from plate under the lid near the hinge).
2. Purchase date from sales slip.

Copy this information in these spaces. Keep this book in the Laundry Information Center with your "Laundry Guide," sales slip and warranty.

There is no warranty registration to return. Proof-of-purchase is all that is required for in-warranty service.

_____ Model Number

_____ Serial Number

_____ Purchase Date

_____ Service Company/
Phone Number

Your responsibilities

Read this "Use and Care Guide" and your "Laundry Guide" carefully for important use and safety information.

You are personally responsible for making sure that your washer...

- is installed by a qualified installer.
- is properly installed and leveled on a floor that can support the weight.*
- is connected to the right kind of outlet, electric supply, water supply and drain.*
- is properly grounded.*
- is used only for jobs normally expected of home automatic washers.
- is properly maintained.
- is protected from the weather and kept where the temperature will not fall below freezing.
- is not run by children or anyone unable to operate it properly.

*See the "Installation Instructions" for complete information.

Contents

	Page
PARTS AND FEATURES	2
YOUR RESPONSIBILITIES	3
SAFETY FIRST	3
STARTING YOUR WASHER	4
WHAT HAPPENS IN EACH CYCLE	6
OTHER OPERATING INSTRUCTIONS	8
For a Rinse and Spin	8
For a Drain and Spin	8
For a Soak or Pre-Wash	8
Liquid Bleach Dispenser	9
Cleaning the Lint Filter	9
Suds-Miser® System (Model LA5705XM only)	10
CARING FOR YOUR WASHER	11
IF YOU NEED SERVICE OR ASSISTANCE	13

Safety first

ALWAYS unplug the power supply cord before attempting to service the washer.

NEVER put flammable fluids (dry-cleaning solvents, gasoline, kerosene) into your washer. **NEVER** use them near your washer.

ALWAYS hand launder or air dry fabrics treated with flammable fluids before putting them into your washer.

NEVER put your hands into the washer until all motion stops. If the lid is opened while the basket is spinning, the basket will automatically stop in a few seconds.

DO NOT allow children to operate or play with the washer.

ALWAYS store detergent, laundry aids and other materials in a cool, dry place where children can't reach them – in a locked cabinet, if possible.

ALWAYS read and follow instructions on packages of detergent and laundry aids – especially warnings and precautions.

POISON GAS can be formed if chlorine bleach is used in the same wash as ammonia or acids such as vinegar or rust remover.

DO NOT machine wash glass fiber materials. Small particles can stick to fabrics washed in following loads and cause skin irritation.

SPECIAL CAUTION: If hot water has not been used recently (usually two weeks or longer), flammable hydrogen gases may build up in the water heater and hot water pipes. To prevent injury or damage, turn on all hot water faucets and allow water to run for several minutes. This will allow gases to escape. Do not smoke or use any open flame near the faucet while it is open.

Starting your washer

Before starting your washer:



1. Measure and add detergent.
2. Place sorted load in washer.
3. Start washer.

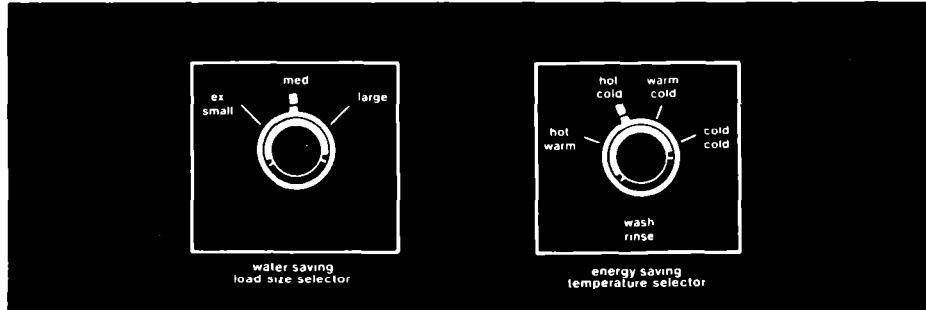

1. LOAD SIZE

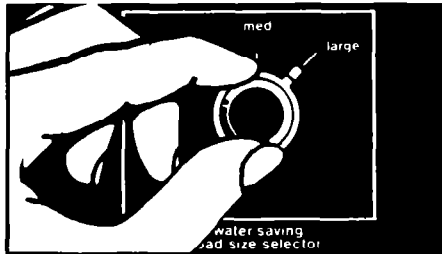

- Turn the knob to point at a setting that describes the size of load you want to wash.
- Set the knob on or between EX SMALL (a few items) and LARGE (a full load).

See your "Laundry Guide" for details on load sizes.

2. TEMPERATURES

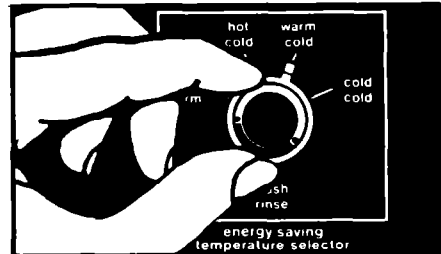

- Match the wash and rinse water temperatures to the type of fabrics and soils being washed.
- This drawing shows a warm wash (top temperature) and cold rinse (bottom temperature) selection.

Recommended wash temperatures can be found in your "Laundry Guide" and printed under the washer lid.

LOAD SIZES AND WATER LEVELS

Use less than a full tub of water when you have less than a full load to wash.

For best cleaning results, the load must be able to move freely in the water. Too big a load or too little water can tear items.

LARGE (16.9 gals./64.0 L)*
 MEDIUM (13.5 gals./51.1 L)*
 EX SMALL (9.9 gals./37.5 L)*

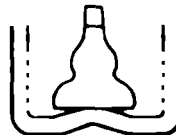

*Approximate fill with load.

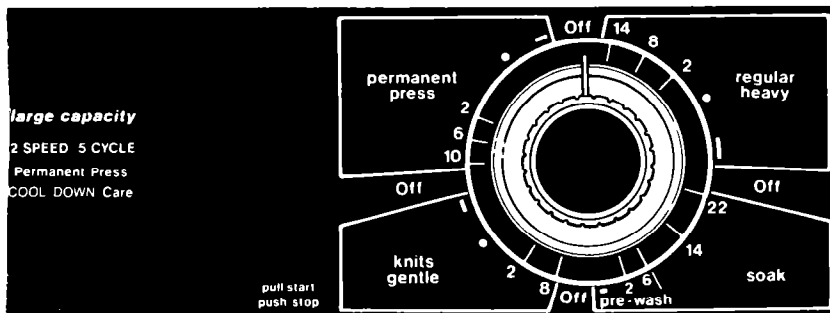

Select CYCLE and WASH TIME; 3. Start the washer

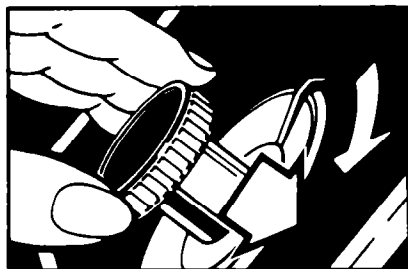

A. Push in the Control Knob and turn it to the right. It must be pushed in and turned only clockwise.

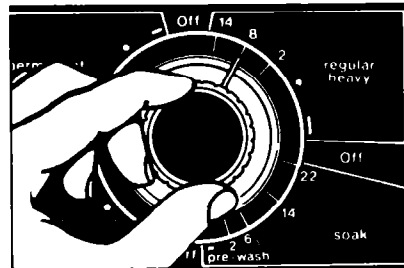

B. Stop on a number in the cycle you want. The numbers are minutes of wash time. The drawing shows 8 minutes of agitation in the REGULAR HEAVY Cycle.

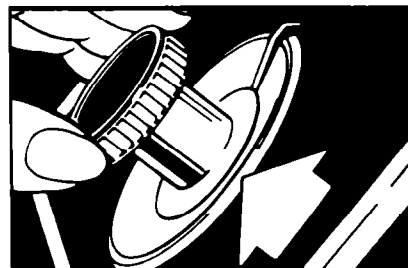

C. Start the washer by pulling out the Control Knob. The washer will fill to the level you set with wash water of the selected temperature. After filling, the washer will agitate for the selected number of minutes.

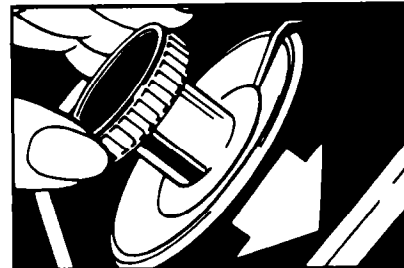

D. To stop the washer at any time push in the Control Knob. To restart the washer, pull out the Control Knob.
To set the controls for a rinse and spin, a drain and spin, or a soak or pre-wash, see page 8.

What happens in each cycle

Each cycle has different agitation and spin speeds designed for different kinds of fabrics. Numbers on the dial in each cycle are the minutes of WASH agitation time.

When the Cycle Control Knob is set to a number and pulled out, the washer fills before agitation and timing start. After agitation starts, the knob turns

REGULAR HEAVY Cycle

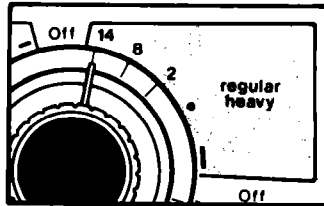

High agitation and spin speeds help remove heavy soils and spin water from heavy or sturdy cotton fabrics.

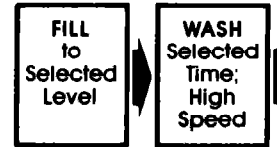

PERMANENT PRESS Cycle

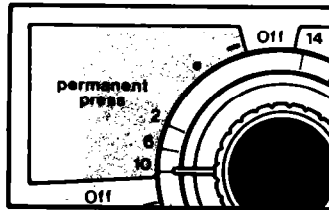

High-speed agitation, low-speed spin and cooling of the wash water before the spin help clean clothing and keep wrinkles from setting into permanent press fabrics.

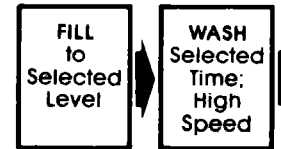

KNITS/GENTLE Cycle

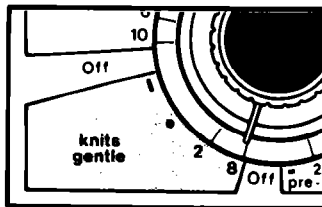

Low agitation and spin speeds and shorter wash time gently wash delicate items and washable synthetic knits.

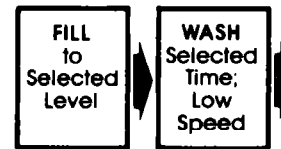

SOAK AND PRE-WASH Cycles

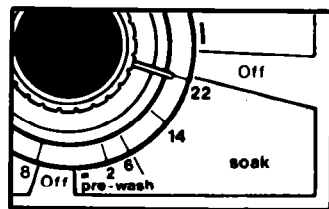

Periods of agitation and soaking time clean stained, yellowed, gray or heavily soiled laundry. Use recommended amount of detergent.

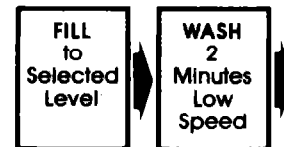

clockwise until it points to OFF and the cycle ends.

NOTE: You may hear the sound of water spraying during the spin parts of some cycles. In some cycles, cold water is sprayed on the spinning load to help with the rinsing.

WHAT HAPPENS IN EACH CYCLE

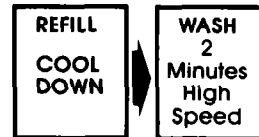
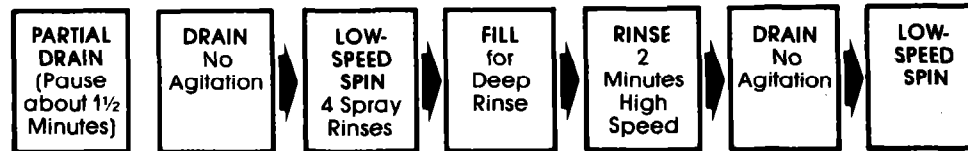
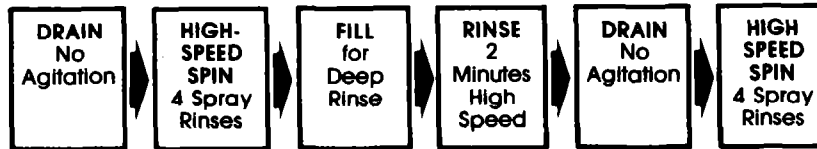

NOTE: Always use **cold rinse water** for permanent press fabrics.

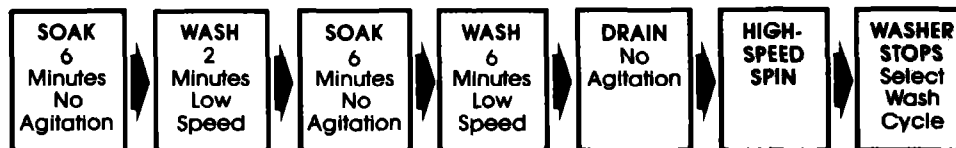
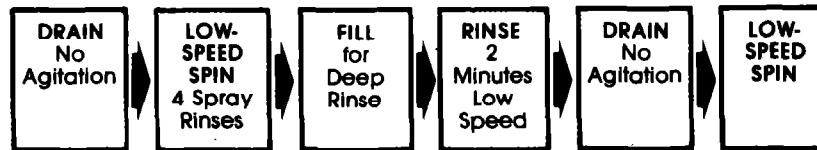

← Pre-wash setting begins here (see page 8)

Special care is needed when soaking or pre-washing laundry. See your "Laundry Guide" for proper use of this cycle.

Other operating instructions

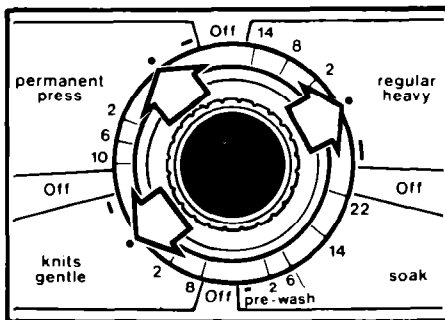

For a rinse and spin

You may need an extra rinse and spin for heavily soiled loads which need more detergent. (Extra detergent can require an extra rinse.)

- Push Control Knob in.
- Turn clockwise to any ● on the dial. **See above drawing.**
- Pull Control Knob out.
- The washer will fill to selected level with cold water, agitate 2 minutes, drain and spin.

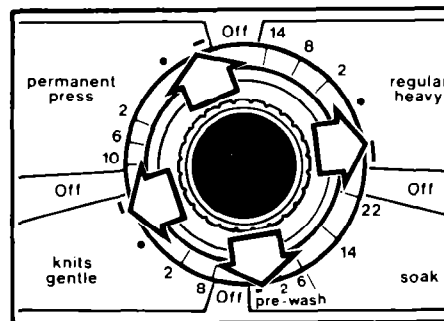

For a drain and spin

Your washer can be set to drain and spin out water.

- Push Control Knob in.
- Turn clockwise to the bar just before OFF in any cycle. **See above drawing.**
- Pull Control Knob out.
- The washer will drain and spin.

For agitation and spin speeds in each cycle, see pages 6 and 7.

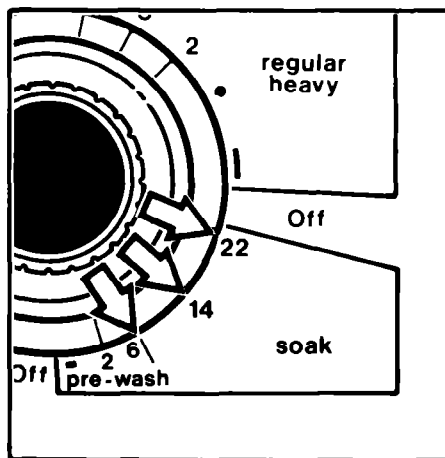

For a soak or pre-wash

For best results, use warm water for soaking or pre-washing stained laundry.

- Use enough detergent or pre-soak product for a single load.
- Push Control Knob in.
- Turn clockwise to point at a **number** in the SOAK Cycle.
- Pull Control Knob out.
- When the cycle is over, add detergent for the next selected wash cycle. **Important: See additional care information on page 7 of your "Laundry Guide."**
- Set the washer and start the next selected wash cycle.

To start the soak or pre-wash with agitation, the Cycle Control Knob must point to a number in the Cycle.

Liquid bleach dispenser

Always measure bleach. Do not guess. Follow directions on the bottle for the amount to use. **Never use more than 1 cup (250 mL) for a full load.** Use less with lower water level settings. Use a cup with a pouring spout to avoid spilling.

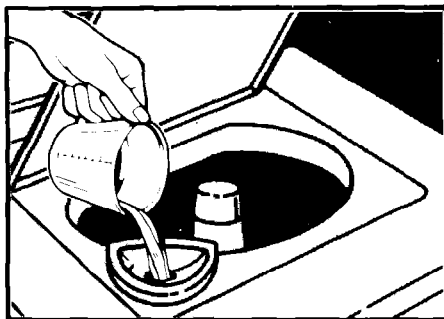
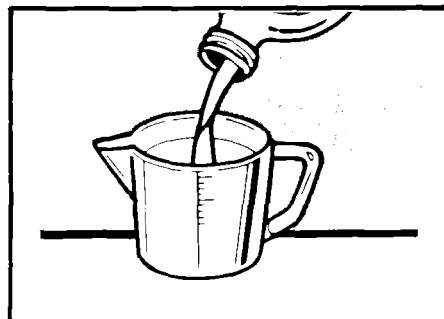

For more information on bleaching, see "Laundry Guide" page 11.

Cleaning the lint filter

Water runs through the lint filter whenever the washer agitates. Check it often to make sure it's clean and is filtering at its best.

To remove it for cleaning, press the release and pull straight out. Instructions for cleaning are printed on the bottom of the filter.

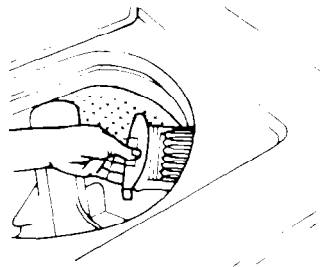

For Model LA5705XM

The SUDS-MISER[™] System

Your washer has the SUDS-MISER[™] System. It has two drain hoses. One hose moves a portion of used wash water into a storage tub and moves it back into the washer for use during the next wash. The other hose carries water to another tub with an open drain, or to a standpipe drain.

If you do not want to re-use wash water for a load, leave the stopper out of the storage tub so the water drains away.

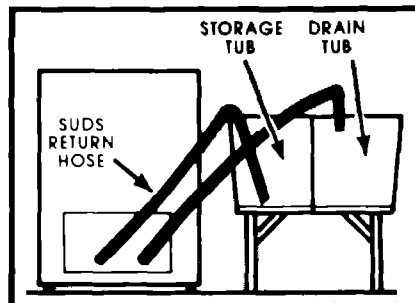
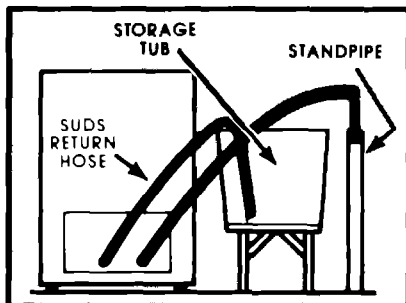

The SUDS-MISER[™] System stores a portion of the wash water.

If you have a storage tub big enough to hold 25 gallons (95 liters) of water, you can have a qualified installer convert your washer to save more of the water.

To save wash water

Be sure the stopper is in the storage tub. The SUDS-MISER System does not save rinse water from any cycle, nor does it save wash water from the PERMANENT PRESS Cycle.

To re-use wash water

1. Set Cycle Control Knob on SUDS (see illustration).
2. Pull the Control Knob out. The washer will pump **most** of the water from the storage tub back into the washer basket. **Do not add clothes at this time.** The washer will finish filling with fresh water.
3. When the water has been pumped back into the washer, **push in the Cycle Control Knob.**
4. Add about $\frac{1}{2}$ the recommended amount of detergent.
5. Put in the clothes.
6. Pull out the Cycle Control Knob to start the washer.
7. Drain the storage tub. **Water still in the tub will have any soil that has settled out. The hose is cut on an angle to leave behind about an inch of water and any soil from previous wash.**

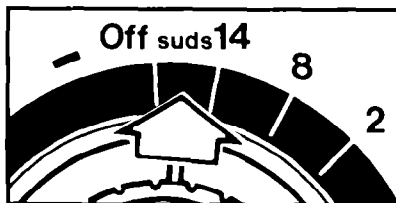

If you want a cycle other than REGULAR HEAVY to follow SUDS, push in the Cycle Control Knob after the water has been pumped back into the washer. Turn the knob right (clockwise) to the cycle and wash time you want.

Caring for your washer

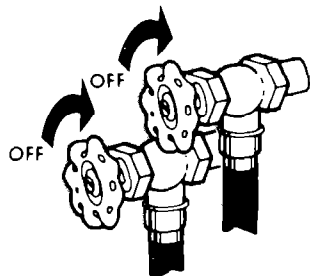

WHEN NOT WASHING, keep both water faucets turned off. This takes the pressure off the water inlet valve and hoses.

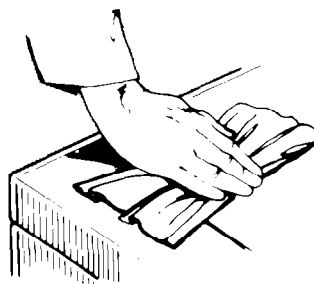

AFTER WASHING, use a soft dry cloth to wipe the outside and inside dry. Leave the lid up until the basket is dry. **Wipe up spills right away.** Spills can dull or damage the finish.

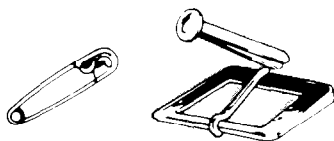

REMOVE SHARP OBJECTS such as pins, buckles, etc., from clothes before washing. Close metal zippers.

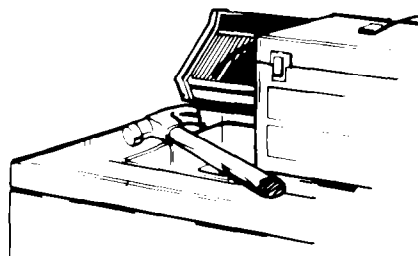

SHARP OR HEAVY OBJECTS should never be put on or in the washer. Check pockets for bolts, nuts, tools, etc.

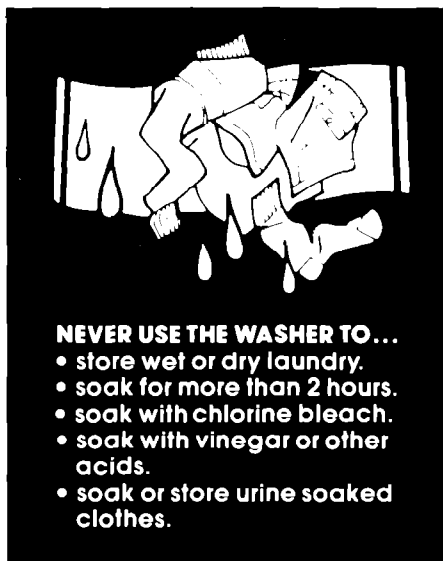

NEVER USE THE WASHER TO...

- store wet or dry laundry.
- soak for more than 2 hours.
- soak with chlorine bleach.
- soak with vinegar or other acids.
- soak or store urine soaked clothes.

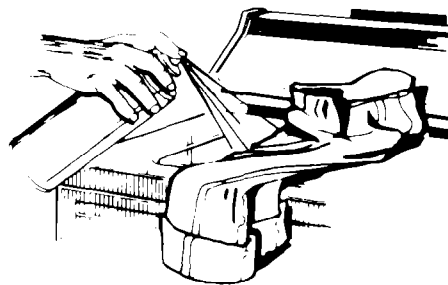

SOME PRETREATMENT PRODUCTS can damage washer and dryer dials, consoles and finishes. Do not use these products on or near your washer or dryer.

SUDS-MISER® SYSTEM (FOR MODEL LA5705XM ONLY) • CARING FOR YOUR WASHER

Service or performance problems caused by the use of any product not manufactured by Whirlpool Corporation are the responsibility of the manufacturer of that product.

Winterizing

Because some water stays in the washer, freezing can cause a lot of damage. If your washer is **stored or moved** during the cold weather...

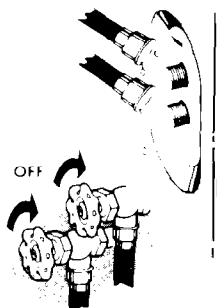
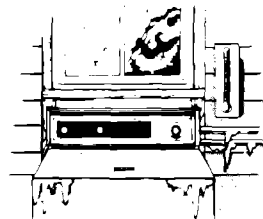

1. Shut off both water faucets. Disconnect and drain water inlet hoses.



2. Put a quart of automobile-type antifreeze in the basket.

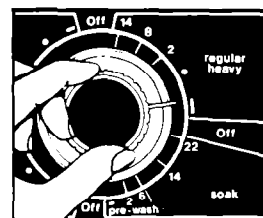

3. Set the washer for a DRAIN and SPIN (see page 8). Let it run for about 30 seconds to mix the antifreeze and water.

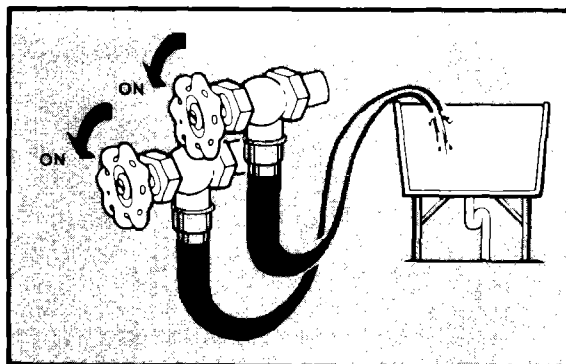

To use the washer again...

1. Flush water pipes and hoses.
2. Connect hoses to the washer.
3. Turn on the water faucets.

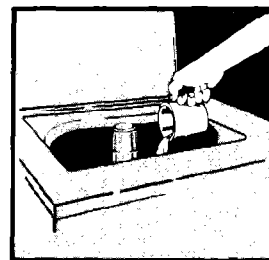

4. Run the washer through a complete cycle with one cup of detergent to clean out the antifreeze.

If you need service or assistance, we suggest you follow these four steps:

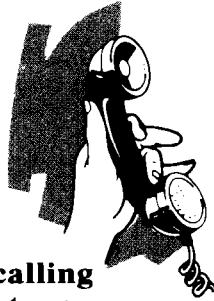

1. Before calling for assistance...

Performance problems often result from little things you can find and fix yourself without tools of any kind.

IF YOUR WASHER DOES NOT FILL:

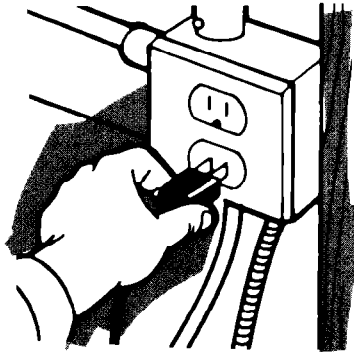

- Is the power supply cord plugged in?

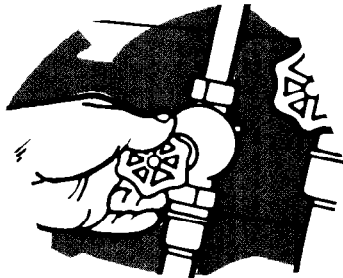

- Are both water faucets open?

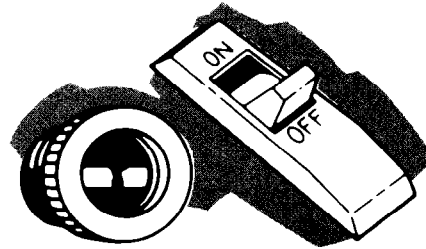

- Are fuses blown or circuit-breaker tripped?
- Are the water supply hoses kinked?
- Is the Cycle Control Knob set and pulled out?

IF YOUR WASHER DOES NOT SPIN:

- Is the lid closed?
- Is the power supply cord plugged in?
- Is a fuse blown or circuit-breaker tripped?

IF YOUR WASHER STOPS DURING THE PERMANENT PRESS CYCLE:

- Remember, the washer will stop for about 1½ minutes after the partial drain during the cool-down period in this cycle.

IF WASHER FILLS AND DRAINS WITHOUT RUNNING:

- Make sure that the Cycle Control Knob is pointing to a number in the cycle.

MAKE SURE THE DRAIN HOSE IS HIGHER THAN THE WATER LEVEL IN THE WASHER. IF IT ISN'T...

- The washer may seem to be draining during wash and rinse cycles.
- Water can siphon out. (See "Installation Instructions.")

2. If you need assistance*...

Call Whirlpool COOL-LINE™ service assistance telephone number. Dial free from:

Continental U.S. . (800) 253-1304
Michigan (800) 632-2243
Alaska & Hawaii (800) 253-1121

and talk with one of our trained Consultants. The Consultant can instruct you in how to obtain satisfactory operation from your appliance or, if service is necessary, recommend a qualified service company in your area.

3. If you need service*...



Whirlpool has a nationwide network of franchised TECH-CARE® Service Companies. TECH-CARE service technicians are trained to fulfill the product warranty and provide after-warranty service, anywhere in the United States. To locate TECH-CARE service in your area, call our COOL-LINE service assistance telephone number (see Step 2) or look in your telephone directory Yellow Pages under:

APPLIANCES - HOUSEHOLD - MAJOR - SERVICE & REPAIR
OR
ELECTRICAL APPLIANCES - MAJOR - REPAIRING & PARTS
WHIRLPOOL APPLIANCES FRANCHISED TECH-CARE SERVICE
OR
WHIRLPOOL APPLIANCES FRANCHISED TECH-CARE SERVICE
SERVICE COMPANIES
XYZ SERVICE CO
123 Maple 999-9999
OR
WASHING MACHINES, DRYERS & IRONERS - SERVICING
WHIRLPOOL APPLIANCES FRANCHISED TECH-CARE SERVICE
SERVICE COMPANIES
XYZ SERVICE CO
123 Maple 999-9999

4. If you have a problem*...

Call our COOL-LINE service assistance telephone number (see Step 2) and talk with one of our Consultants, or if you prefer, write to:

Mr. Guy Turner, Vice President
Whirlpool Corporation
Administrative Center
2000 US-33 North
Benton Harbor, MI 49022

*If you must call or write, please provide: model number, serial number, date of purchase, and a complete description of the problem. This information is needed in order to better respond to your request for assistance.



FSP is a registered trademark of Whirlpool Corporation for quality parts. Look for this symbol of quality whenever you need a replacement part for your Whirlpool appliance. FSP replacement parts

will fit right and work right, because they are made to the same exacting specifications used to build every new Whirlpool appliance.



Making your world a little easier.

Part No. 385025 Rev. B
©1984 Whirlpool Corporation

Printed in U.S.A.

Automatic Washers, Clothes Dryers, Freezers, Refrigerator-Freezers, Ice Makers, Dishwashers, Built-In Ovens and Surface Units, Ranges, Mi

