

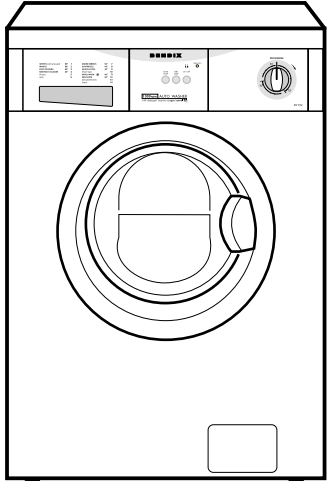

**OPERATING & INSTALLATION
INSTRUCTIONS**

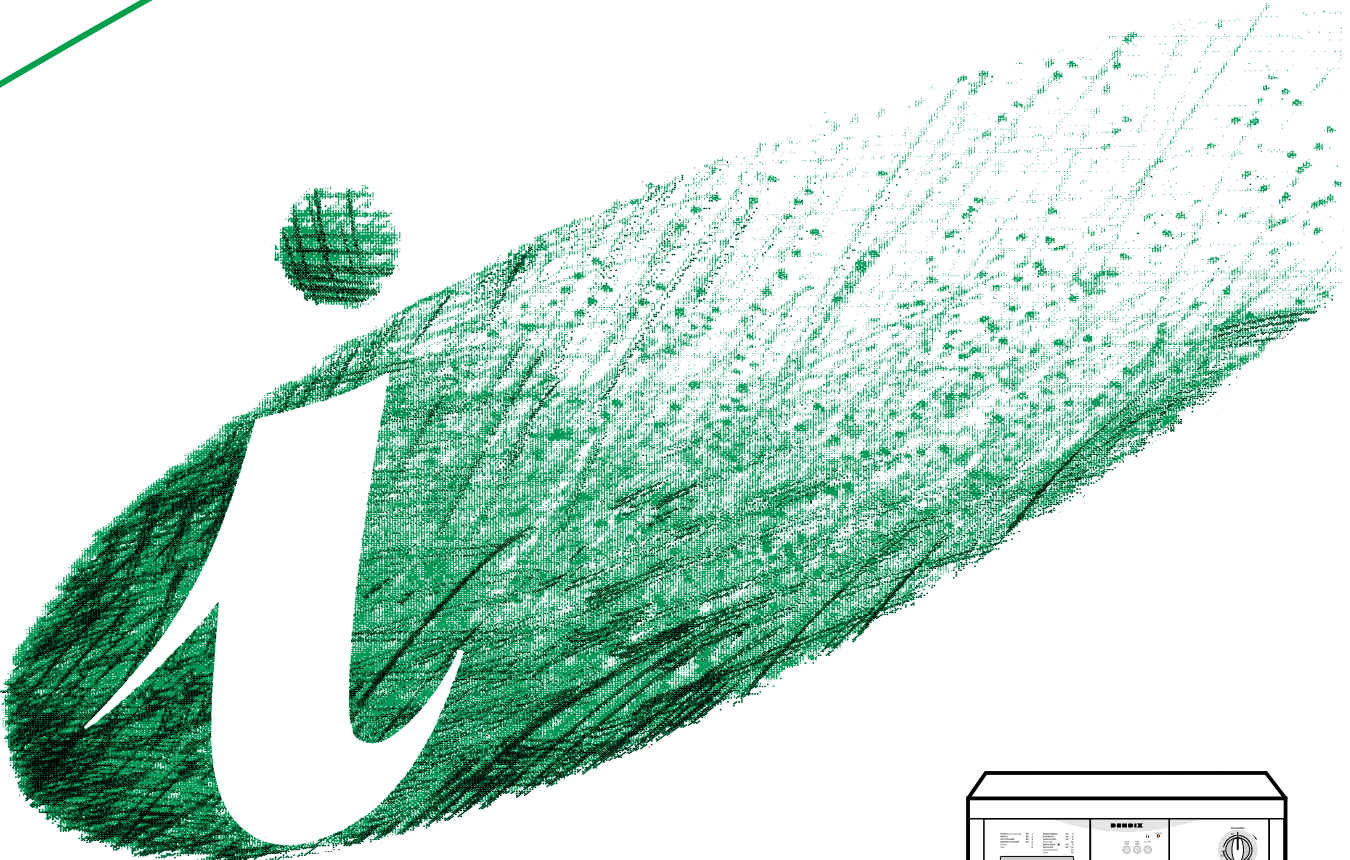

WASHING MACHINE

BIW 103 W



Important Safety Information

It is most important that this instruction book should be retained with the appliance for future reference. Should the appliance be sold or transferred to another owner, or should you move house and leave the appliance, always ensure that the book is supplied with the appliance in order that the new owner can get to know the functioning of the appliance and the relevant warnings.

These warnings have been provided in the interest of safety. You **MUST** read them carefully before installing or using the appliance.

Installation

- This appliance is heavy. Care should be taken when moving it.
- It is dangerous to alter the specifications or attempt to modify this product in any way.
- All packing and transit bolts must be removed before use. Serious damage can occur to the product and to property if this is not adhered to. See relevant section in instructions.
- Any plumbing work required to install this appliance should be carried out by a qualified plumber or competent person.
- Any electrical work required to install this appliance should be carried out by a qualified electrician or competent person.
- Care must be taken to ensure that the appliance does not stand on the electrical supply cable.
- If the machine is situated on a carpeted floor, please adjust the feet in order to allow air to circulate freely.

Child Safety

- This appliance is designed to be operated by adults. Children should not be allowed to tamper with the controls or play with the product.
- Pets and children have been known to climb into washing machines. Please check your drum before use.
- The glass door becomes very hot during the washing cycle. Keep children away from the vicinity of the appliance whilst it is in operation.
- Keep all packaging well away from children.
- Keep all detergents in a safe place out of children's reach.

Use

- Always unplug the appliance and turn off the water supply after use.
- Do not overload the appliance. See relevant section in the instruction book.

- Always look through the glass door to check if water has drained before opening the door.
- The user should always check that they have not left their gas lighter (disposable or otherwise) in their clothing.
- Only wash fabrics which are designed to be machine washed. If in doubt, consult the care label on the clothes.
- Before washing, ensure that all pockets are empty and buttons and zips are fastened. Avoid washing frayed or torn articles and treat stains such as paint, ink, rust, and grass before washing. Underwired bras must NOT be machine washed.
- Any objects such as coins, safety pins, nails, screws, stones or any other hard, sharp material can cause extensive damage and must not be placed into the machine.
- Garments which have been in contact with volatile petroleum products should not be machine washed. If volatile cleaning fluids are used, care should be taken to ensure that the fluid is removed from the garment before placing in the machine.
- Wash small items such as socks, laces, washable belts etc in a washing bag or pillow case as it is possible for such items to slip down between the tub and the inner drum.
- Only use the advised quantities of fabric softener. Damage to the fabric can ensue if you over-fill. Refer to the manufacturer's recommendations of quantities.
- As some duvets and eiderdowns should be washed in large commercial machines because of their bulk, please check with the manufacturer of the item before washing in a domestic machine.
- Leave the porthole door slightly ajar between washes to preserve the door seal.
- Under no circumstances should you attempt to repair the machine yourself. Repairs carried out by inexperienced persons may cause injury or serious malfunctioning. Contact your local Bendix Service Centre. Always insist on genuine Bendix spare parts.

Contents

For the User

Important Safety Information	2
Your New Washing Machine	4
Description of the Appliance	5
Detergent dispenser drawer	5
The Control Panel	6
Operating sequence	7-10
Washing 4.5 kg of white cotton at 90°C	7
Load the laundry	7
Measure out the detergent	7
Measure out the fabric softener	7
Select the required option	7
Select the required programme	7
Start the machine	8
At the end of the programme	8
Washing 2 kg of mixed fabrics at 50°C	9
Load the laundry	9
Measure out the detergent	9
Measure out the fabric softener	9
Select the required option	9
Select the required programme	9
Start the machine	9
At the end of the programme	9
Washing Hints	10-11
Which detergent?....	11
And in which form?	11
Wash Care Symbols	12
Washing Programmes	13-14
Maintenance and Cleaning	15-16
Descaling	15
After each wash	15
Maintenance Wash	15
External cleaning	15
Cleaning the dispenser drawer	15
Cleaning the drawer recess	15
Cleaning the pump	15
Cleaning the water inlet filters	16
The dangers of freezing	16
Emergency emptying out	16

Something Not Working	17-18
Service and Spare Parts	18
Customer Care	18
Guarantee Conditions	19

For the Installer

Installation Instructions	20
Technical Specifications	20
Unpacking	21
Positioning	22
Installation on a Suspended Floor	22
Water inlet	22
Water drainage	23
Levelling	24
Special conditions	24
In the interest of the environment	24
Electrical connection	25
Permanent connection	25

Guide to use the Instruction Book

The following symbols will be found in the text to guide you throughout the instructions:



Safety instructions



Hints and tips



Environmental information



Your New Washing Machine

Your new washing machine meets all modern requirements for effective treatment of laundry with low water, energy and detergent consumption.

- **Automatic cooling of the wash water to 60°C** before draining, with the 90°C programme. This reduces thermal shock to fabrics, helping to prevent creasing.
- **The special wool programme** with its new delicate wash system treats your woollens with extreme care.
- **The ECO VALVE** allows total use of detergent and reduces water consumption so saving energy.



Ecological hints

To save water and energy and help protect the environment, we recommend that you follow these hints:

- Adjust the quantity of detergent according to the hardness of your water supply, the amount of laundry and the degree of soiling.
- A programme without prewash is sufficient for normally soiled laundry.
- The machine works more economically if it is fully loaded.
- With adequate pre-treatment, stains and limited soiling can be removed; the laundry can then be washed at a lower temperature, so saving energy.



In the interest of the environment

- Materials marked with the symbol  are recyclable.
- Check with your local Council or Environmental Health Office to see if there are facilities in your area for re-cycling this appliance.
- When the appliance is to be scrapped, cut off the power supply cable and make the door lock device unusable to prevent young children from being trapped inside.
- Help to keep your country tidy - use authorised disposal sites for your old appliance.

**How do we help to protect the environment?
We use recycled paper!**

Important



Your machine is fitted with a balance control device, which ensures the machine is stable during the spin. If the wash load appears not to have been spun sufficiently at the end of the wash cycle, because it is not evenly distributed in the drum, the balance control device may have operated. It will therefore be necessary to redistribute the wash load manually and select a spin programme. For more detailed information see the section headed "Something Not Working".

Description of the Appliance

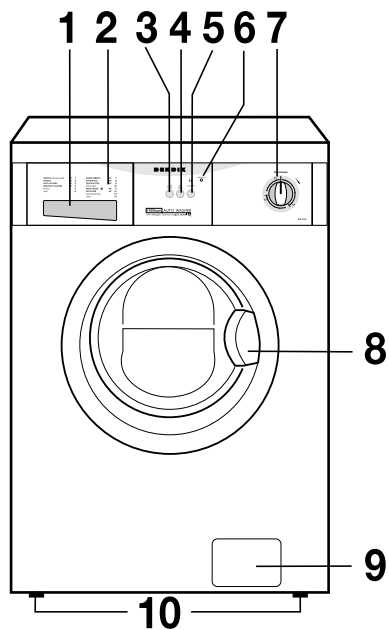
- 1 Detergent dispenser drawer
- 2 Programme guide
- 3 Rinse hold button
- 4 Half load button
- 5 ON/OFF button
- 6 Mains-on light
- 7 Programme selector dial
- 8 Door opening handle
- 9 Drain pump
- 10 Adjustable feet



Detergent dispenser drawer

-  Prewash
-  Main wash
-  Fabric softener

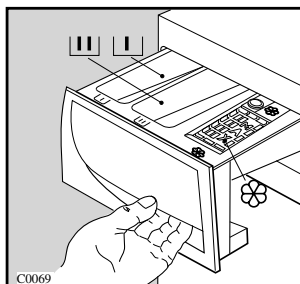

The Control Panel

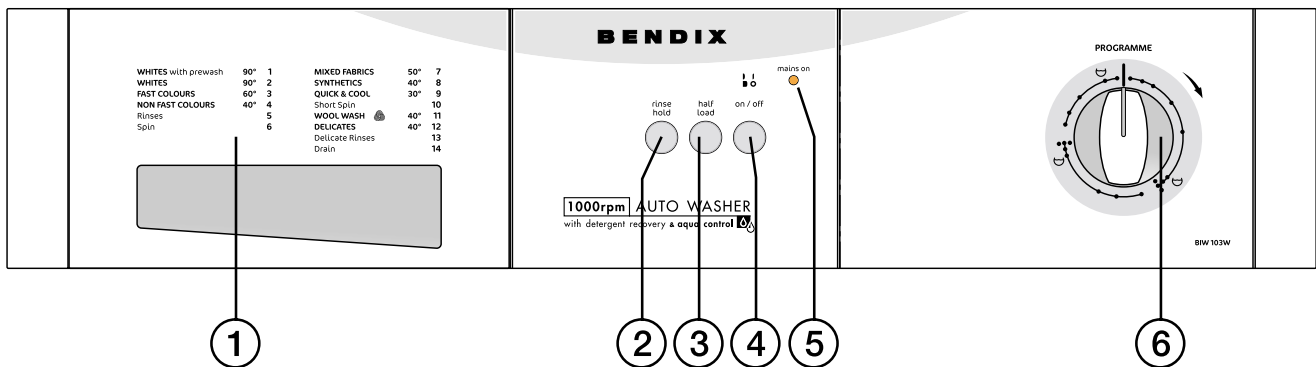

1 Programme guide

2 RINSE HOLD button

Press this button to make the machine stop with water in the drum after the wash cycle. This prevents any creasing which may take place if the clothes are left damp in the drum. When it is convenient for you to empty the machine, simply press this button again so that the machine can proceed to drain and short spin, or turn the dial to the drain programme **14**. If this button is not activated, the washing programmes will end with a short spin.

3 HALF LOAD button

Select this button to reduce water consumption on the rinse cycle when washing a smaller load of cottons or linens (maximum load size = 2.25 kg).

4 On/Off button

By depressing this button the machine starts operating. When depressed again, the machine stops.

5 Mains-on light

This light illuminates when the machine starts working and goes out when the machine is switched off.

6 Programme selector dial

To select the required program turn the control clockwise until the marker on the top coincides with the number of the required program (reference mark on the control panel). If at any chance you pass by the required number **NEVER TURN THE CONTROL ANTICLOCKWISE** just continue clockwise until the required number is reached again.

Before setting the dial to any position ensure that the machine is switched off.

i Operating Sequence

Before the first wash, we recommend that you run a cotton cycle at 60°C, without any laundry in the machine, to remove any manufacturing residue from the drum and tub.

Pour 1/2 a measure of detergent into the dispenser drawer and start the machine.

WASHING 4.5 KG OF WHITE COTTON AT 90°C

Suppose you have 4.5 kg of normally soiled laundry to wash. It is white cotton and is suitable for high temperature washing.

1. Load the laundry

Open the door by pulling the door handle outwards. Place the laundry in the drum, one item at a time, shaking them out as much as possible. Close the door.

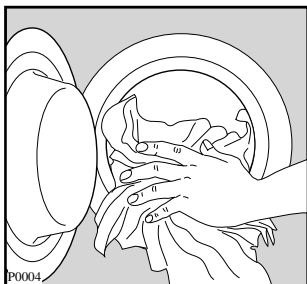

2. Measure out the detergent

Pull out the dispenser drawer until it stops. Measure out the amount of detergent required and pour it into the main wash compartment **II**. If you wish to carry out the prewash, pour detergent into the compartment marked **I**.

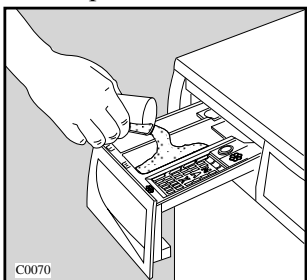

3. Measure out the fabric softener

If required, pour fabric softener into the compartment marked **III** (the amount used must not exceed the MAX mark in the drawer).

Close the drawer gently.

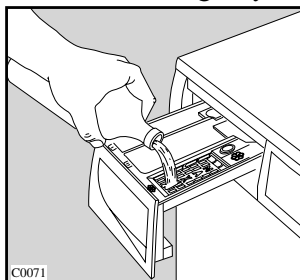

4. Select the required option

Depress RINSE HOLD button or HALF LOAD if required.

5. Select the required programme

Turn the programme selector dial **clockwise** until the marker on the top coincides with the programme **2** or **1** (if you wish to perform a prewash).

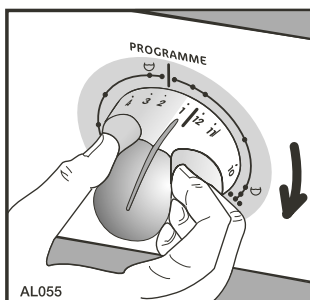

6. Start the machine

Before starting up the machine check that:

- the appliance is plugged in
- the water supply taps are turned on
- the drain hose is correctly and securely positioned
- the door and the detergent dispenser drawer are closed.

Depress the ON/OFF button: the mains-on light will illuminate and the machine starts operating.

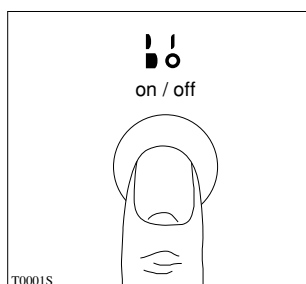

7. At the end of the programme

The machine stops automatically.

The door is controlled by a safety device which releases 2 minutes after the end of the programme.

Switch the machine off by depressing the ON/OFF button again. The mains-on light goes out.

When the programme has finished you are advised to unplug the appliance and turn off the water taps.

WASHING 2 KG OF MIXED FABRICS AT 50°C

Suppose you have 2 kg of Mixed fabrics to wash. They are rather delicate fabrics and should not be washed at a high temperature.

1. Load the laundry

Open the door by pulling the door handle outwards. Place the laundry in the drum, one item at a time, shaking them out as much as possible. Close the door.

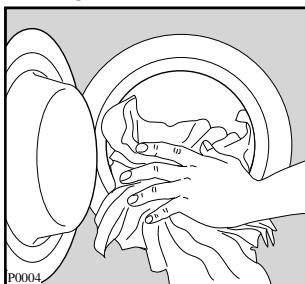

2. Measure out the detergent

Pull out the dispenser drawer until it stops. Measure out the amount of detergent required and pour it into the main wash compartment **II**.

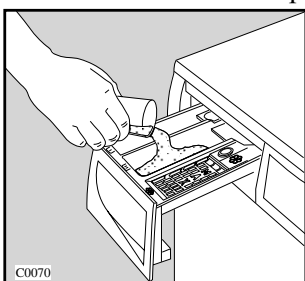

3. Measure out the fabric softener

If required, pour fabric softener into the compartment marked  (the amount used must not exceed the MAX mark in the drawer).

Close the drawer gently.

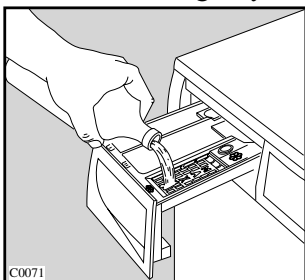

4. Select the required option

Depress the RINSE HOLD button if required.

5. Select the required programme

Turn the programme selector dial **clockwise** until the marker on the top coincides with the programme 7.

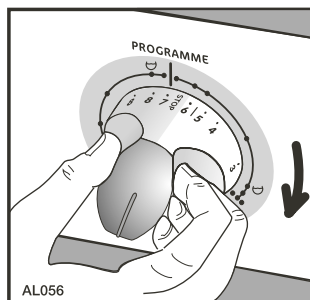

6. Start the machine

Before starting up the machine check that:

- the appliance is plugged in
- the water supply taps are turned on
- the drain hose is correctly and securely positioned
- the door and the detergent dispenser drawer are closed.

Depress the ON/OFF button: the mains-on light will illuminate and the machine starts operating.

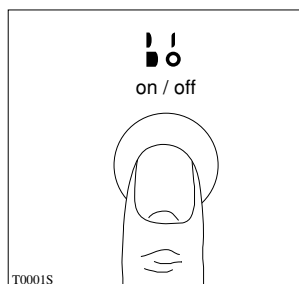

7. At the end of the programme

After the last rinse, the machine stops with the water left in the wash tub, to prevent the fabric from creasing.

To drain the water, select programme **10** (short spin) or **14** (drain).

The door is controlled by a safety device which releases 2 minutes after the end of the programme.

Switch the machine off by depressing the ON/OFF button again. The mains-on light goes out.

When the programme has finished you are advised to unplug the appliance and turn off the water taps.

Washing Hints

Do **NOT** overload the machine. Weigh the laundry the first few times you use the appliance.

The average weights of the most common items are listed below as a guide:

1000g = 1 kg

Sheet	700-1000 g
Pillow case	100-200 g
Tablecloth	400-500 g
Serviette	50-100 g
Tea towel	70-120 g
Linen hand towel	100-150 g
Towelling hand towel	150-250 g
Towelling bath towel	700-1000 g
Bath robe	1000-1500 g
Man s shirt	200-300 g
Apron	150-200 g

- Load the laundry loosely alternating large items with small ones.
- Sort the laundry according to the type of fabric, colour-fastness and how dirty it is.
- Avoid washing unhemmed or torn items as they may unravel.
- Before washing, empty all pockets of small objects which may have been left inside (coins, keys, screws etc). as these could damage the drain pump.
- When washing curtains, remove the hooks.
- Close poppers and zips and fasten loose buttons.
- It is essential to wash new coloured items separately when washing for the first time.
- When washing fabrics requiring different wash temperatures together, always select the lowest temperature.
- White items should not be washed with coloured items.
- Very small items (handkerchiefs, ribbons, socks etc) should be washed in a washing bag or a pillow case.
- Use a good quality detergent suitable for automatic washing machines.
- Use the correct quantities of detergent.

- For wool, use gentle detergent only in small quantities.
- Bleach is very corrosive; it should be used with care and kept out of reach of children.
- Some stains such as fruit, wine, grass, rust etc. are difficult to remove and should be treated before washing with specific products, which can be found in most household shops. In some cases it may help to soak the stain before washing with a special pre-soak product or biological detergent.
- Only wool marked Pure New Wool - washable, preshrunk can be washed in the machine using the wool programme; other types of wool should be washed by hand or dry cleaned.
- If you have used the machine to wash, rinse or spin only non-colour fast garments, there may be dye left in the sump. To ensure any subsequent wash is not contaminated with the dye, select and carry out a rinse and spin programme, without any garments, to ensure that any dye is removed from the sump.
- Once you have finished using the machine, you are advised to unplug it and turn off the water taps.

Which detergent?....

To ensure you obtain the best wash results from your appliance, it is important to use the right detergent in your everyday wash, and only detergents recommended for use in automatic machines.

To maintain the appearance of your clothes and household textiles and to make them last longer you should use different types of detergent for different washes, whether for whites, colours or delicates.

WHITES

We recommend the Ariel product range which is biological and designed to provide excellent cleaning and stain removal even at low temperatures.



NON BIOLOGICAL

If you prefer to use a non biological detergent, which does not contain enzymes we recommend Fairy. Fairy provides good cleaning and stain removal.



COLOURED

For coloured items you should use a detergent which is designed to clean while maintaining the original colour. Ariel Color does not contain bleach and therefore helps to preserve colours.



DELICATE ITEMS

When washing delicates such as woollens, you should use a product which is specially designed to care for fine fabrics.

Dreft Automatic is suitable for woollens and other delicates.



LAUNDRY BLEACH

For additional stain removal you may wish to use a product such as Ace Gentle Bleach which is used in addition to your chosen detergent. Ace is suitable for all washable fabrics including silks, woollens and coloureds.



And in which form?

Not only are there different types of detergent, but they are also available in different forms. Whether you chose a powder or liquid in traditional or compact form is your own personal choice.

TRADITIONAL POWDERS

Pour the powder directly into the dispenser drawer. Do not sprinkle powder onto clothes in the machine drum.

TRADITIONAL LIQUIDS

Liquid can be placed in the main wash compartment of the detergent drawer marked with the symbol , start the machine immediately upon placing the detergent in the dispenser drawer.

Alternatively the detergent is measured into the specially designed dosing device* which should be placed on top of the laundry, and at the back of the machine drum.

COMPACT POWDERS AND LIQUIDS

Compact detergents (or concentrates as they are also known) are available in liquid or powder form, and generally require a smaller dosage. Follow the manufacturer's instructions to ensure the most economical usage. Pour the detergent directly into the dispenser drawer, or alternatively measure the detergent into the specially designed dosing device* which should be placed on top of the laundry, and at the back of the machine drum.

* **If you use a dosing device in a washer dryer, please ensure the dosing device/ball is removed before carrying out a drying programme.**

FABRIC CONDITIONERS

These are ideal for improving softness, and also reduce static cling on synthetics and make ironing easier. They are available in two types:

For example Lenor liquid fabric softener, for use in the **washing machine/washer dryer**. The liquid fabric softener should be poured into the compartment marked with the symbol . Follow the manufacturer's dosage instructions and never exceed the MAX level.



















Bounce conditioning sheets for use in a **tumble dryer**. We recommend the conditioning sheets are pinned (using a safety pin) to an article of laundry and placed in the tumble dryer.



Wash Care Symbols

Wash care labels inside garments recommend how to launder your clothes with the best results. The care labelling code is in line with care labelling used in the rest of Europe. The symbols used make it easy to select the correct programme on your washing machine.

WASHING SYMBOL	WASH ACTION	FABRIC
	Normal (Maximum)	White Cotton or Linen without Special Finishes
	Normal (Maximum)	Cotton, Linen or Viscose without Special Finishes Colourfast at 60°C.
	Reduced (Medium)	Nylon, Polyester/Cotton, Viscose with Special Finishes, Cotton/Acrylic Mix.
	Normal (Maximum)	Cotton, Linen or Viscose Colourfast at 40°C but not 60°C.
	Reduced (Medium)	Acrylics, Acetate, Triacetate, Wool mixes, Polyester/wool blends.
	Much Reduced (Minimum)	Wool, wool mixtures, Silks
	Hand wash only	Do not machine wash
BLEACHING		
	Chlorine bleach may be used	
IRONING		
	Hot iron	Cotton, Linen, Viscose
	Warm iron	Polyester mixtures, Wool
	Cool iron	Acrylic, Nylon, Polyester
DRY CLEANING		
	May be dry cleaned. Other letters and/or a bar beneath the circle will indicate the required process to the dry cleaner.	
TUMBLE DRYING		
	with high heat setting	
	with low heat setting	
	May be tumble dried	
	A cross through any symbol means DO NOT	

Important Notes





For best results, always use the dispenser drawer for dispensing detergents and liquid additives. Once the dispenser has been filled, close it by pushing it in gently. This is particularly important if you are using

fabric conditioner to avoid the conditioner entering the machine prematurely.

When using liquid detergent and a prewash programme, place the detergent into the correct compartment in the dispenser drawer, after the prewash has finished.

Washing Programmes

Programmes for cotton and linen

Wash programme	Degree of soil and type of laundry	Programme dial position	Description	Possible options	Max. load	Progr. time mins.
 Whites+Prewash	White cotton, for example heavy soiled garments, sheets, household linen, underwear, towels.	1	Prewash at 40 °C Wash at 90°C 3 rinses Long spin (**)	rinse hold half load	4.5 kg	145
 Whites	White cotton, for example normally soiled garments, sheets, household linen, underwear, towels.	2	Wash at 90°C 3 rinses Long spin (**)	rinse hold half load	4.5 kg	120
 Fast coloureds	Fast coloured cotton or linen fabric, shirts, underwear, towels. (normally soiled)	3 (*)	Wash at 60°C 3 rinses Long spin (**)	rinse hold half load	4.5 kg	135
 Non fast coloureds	Non fast coloured cotton or linen fabrics, shirts, blouses, underwear.	4	Wash at 40°C 3 rinses Long spin (**)	rinse hold half load	4.5 kg	115
Rinses	Separate rinse cycle for hand washed garments.	5	4 rinses Long spin (**)	rinse hold	4.5 kg	58
Spin	Separate spin for cotton and linen items	6	Long spin		4.5 kg	12

(*) This programme at 60°C with cold water filling and a wash load of 4.5 kg is the reference programme for the Energy label according to EEC Directive 92/75.

Water filling: 30i-40i programmes: **cold** water filling
50i-60i programmes: **hot** and **cold** filling
90i programmes: **hot** water filling

The programme times are intended as a guide only. The actual time will vary depending on incoming water temperature and pressure.

(**) If the rinse hold button has not been depressed.

Important!

¥Some programmes when selected may start with a short drain. This is quite normal and not a fault with the appliance.

When a programme is selected, the selector dial will advance to the water filling position. E.g. Programme 2 is selected, there is a short drain. The appliance takes in water and the selector will appear to move to the 3 position.

The appliance will have memorised the programme selected, in this case 2, and will run the correct programme even though the selector dial appears to be at position 3.

¥We recommend you not to switch the appliance off and on during its operation. This would modify the memorised programme in progress with unsatisfactory washing results.

Washing Programmes

Programmes for synthetics, delicates and wool

Wash programme	Degree of soil and type of laundry	Programme dial position	Description	Possible options	Max. load	Progr. time mins.
 Mixed fabrics	Synthetic or mixed fabrics, underwear, coloured garments, non-shrink shirts, blouses.	7	Prewash Wash at 50°C 3 rinses Short spin (*)	rinse hold	2 kg	60
 Synthetics	Synthetic or mixed fabrics, underwear, coloured garments, non-shrink shirts, blouses.	8	Wash at 40°C 3 rinses Short spin (*)	rinse hold	2 kg	60
 Quick & Cool	Lightly soiled synthetic or delicate items	9	Wash at 30°C 3 rinses Short spin (*)	rinse hold	2 kg	30
Short spin	Separate spin for synthetics and delicates	10	Draining of water and short spin (*)		2 kg	6
 Wool wash	Specially tested programme for wool garments	11	Wash at 40°C 3 rinses Short spin (*)	rinse hold	1 kg	50
 Delicates	Delicate fabrics, for example curtains.	12	Wash at 40°C 3 rinses Short spin (*)	rinse hold	2 kg	45
Delicate Rinses	Separate rinse cycle for hand washed garments	13	3 rinses (with fabric softener if required) Short spin (*)	rinse hold	2 kg	20
Drain	For emptying out the last rinse water in programmes with Rinse Hold option	14	Draining of water		-	1

(*) If the rinse hold button has not been depressed.

Important!

¥Some programmes when selected may start with a short drain. This is quite normal and not a fault with the appliance.

When a programme is selected, the selector dial will advance to the water filling position.

¥We recommend you not to switch the appliance off and on during its operation. This would modify the memorised programme in progress with unsatisfactory washing results.

Maintenance and Cleaning

Before any maintenance or cleaning is carried out you must **DISCONNECT** the appliance from the electricity supply.

Descaling

The water we use normally contains lime. It is a good idea to periodically use a water softening powder in the machine. Do this separately from any laundry washing, and according to the softening powder manufacturer's instructions. This will help to prevent the formation of lime deposits.

After each wash

Leave the door open for a while. This helps to prevent mould and stagnant smells forming inside the appliance. Keeping the door open after a wash will also help to preserve the door seal.

Maintenance Wash

With the use of low temperature washes it is possible to get a build up of residues inside the drum. We recommend that a maintenance wash be performed on a regular basis.

To run a maintenance wash:

- The drum should be empty of laundry.
- Select the hottest cotton wash programme.
- Use a normal measure of detergent, must be a powder (such as Ariel Futur).

External cleaning

Clean the exterior cabinet of the appliance with soap and water only, and then dry thoroughly.

Cleaning the dispenser drawer

The washing powder and additive dispenser drawer should be cleaned regularly.

Remove the drawer by pressing the catch downwards and by pulling it out. Flush it out under a tap, to remove any traces of accumulated powder.

To aid cleaning, the top part of the additive compartment should be removed.

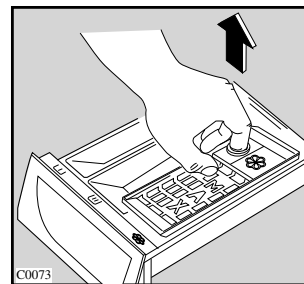
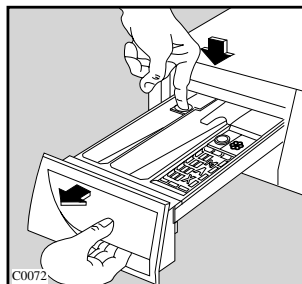

Cleaning the drawer recess

Having removed the drawer, use a small brush to clean the recess, ensuring that all washing powder residue is removed from the upper and lower part of the recess. Replace the drawer and run the rinse programme without any clothes in the drum.

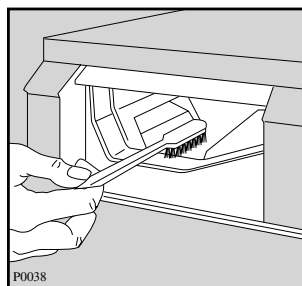

Cleaning the pump

The pump should be inspected regularly and particularly if

- ✘ the machine does not empty and/or spin
- ✘ the machine makes an unusual noise during draining due to objects such as safety pins, coins etc. blocking the pump.

Proceed as follows:

- ✘ Disconnect the appliance.
- ✘ If necessary wait until the water has cooled down.
- ✘ Open the pump door.

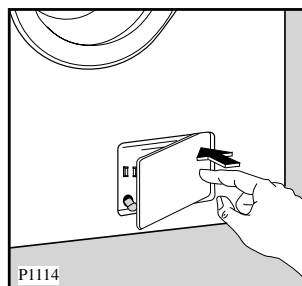

- ✘ Place a container close to the pump to collect any spillage.
- ✘ Pull out the emergency emptying hose, place it in the container and remove its cap.

☞ When no more water comes out, unscrew the pump cover and remove it. Always keep a rag nearby to dry up spillage of water when removing the cover.

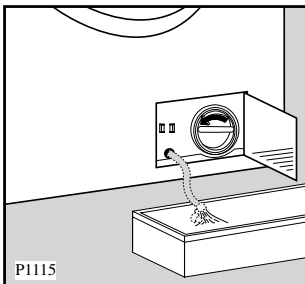

- Remove any objects from the pump impeller by rotating it.

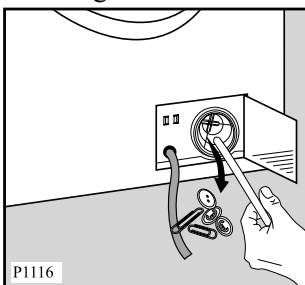

☞ Put the cap back on the emergency emptying hose and place the latter back in its seat.

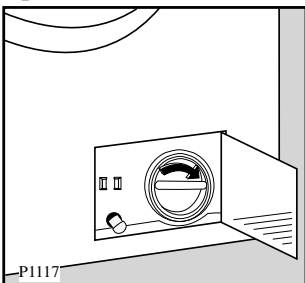

☞ Screw the pump cover fully in.
☞ Close the pump door.

Warning

When the appliance is in use and depending on the programme selected there can be hot water in the pump circuit. Never remove the pump cover during a wash cycle, always wait until the appliance has finished the cycle, and is empty. When replacing the pump cover, after a cleaning inspection, ensure it is securely retightened so as to stop leaks and young children being able to remove it.

Cleaning the water inlet filters

If your water is very hard or contains traces of lime deposit, the water inlet filters may become clogged.

It is therefore a good idea to clean it from time to time. Turn off the water taps. Unscrew the water inlet hoses.

Clean the filters using a hard bristle brush.

Tighten up the inlet hoses.

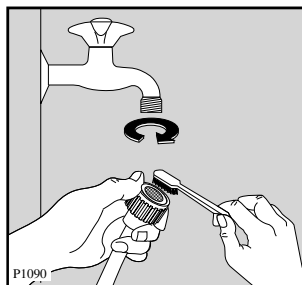

The dangers of freezing

If the machine is exposed to temperatures below 0°C, certain precautions should be taken.

- Turn off the water taps.
- Unscrew the inlet hoses.
- Place the end of the emergency emptying hose and that of the inlet hoses in a bowl placed on the floor and let water drain out.
- Screw the water inlet hoses back on and reposition the emergency emptying hose after having put the cap on again.
- When you intend to start the machine up again, make sure that the room temperature is above 0°C.

Important!

Every time you drain the water through the emergency emptying hose you must pour 2 litres of water into the main wash compartment of the detergent drawer and then run the drain programme. This will activate the ECO valve avoiding that part of the detergent remains unused at next washing.

Emergency emptying out

If the water is not discharged, proceed as follows to empty out the machine:

- ☞ pull out the plug from the power socket;
- ☞ close the water tap;
- ☞ if necessary, wait until the water has cooled down;
- ☞ open the pump door;
- ☞ place a bowl on the floor and place the end of the emergency emptying hose into the bowl. Remove its cap. The water should drain by gravity into the bowl. When the bowl is full, put the cap back on the hose. Empty the bowl. Repeat the procedure until water stops flowing out;
- ☞ clean the pump if necessary as previously described;
- ☞ replace the emergency emptying hose in its seat after having plugged it;
- ☞ screw the pump cover again and close the door.

Something Not Working

Certain problems are due to lack of simple maintenance or oversights, which can be solved easily without calling out an engineer. Before contacting your local Service Force Centre, please carry out the checks listed below.

IMPORTANT: if you call out an engineer to a fault listed below, or to repair a fault caused by incorrect use or installation, a charge will be made even if the appliance is under guarantee.

Symptom	Possible causes
The machine does not start	<ul style="list-style-type: none"> • The door has not been closed. • The plug is not properly inserted in the power socket. • There is no supply at the socket • The main fuse or the fuse in the plug has blown. • The selector dial is not correctly positioned. • The ON/OFF button has not been depressed.
The machine does not fill	<ul style="list-style-type: none"> • Ensure the water taps are open. • The filters in the inlet hoses are blocked. • The inlet hoses may be squashed or kinked. • The door has not been closed.
The machine fills then empties immediately	<ul style="list-style-type: none"> • The end of the drain hose is too low. • The end of the drain hose is submerged in water. • There is no vent in the end of the drain hose.
The machine does not empty and/or does not spin	<ul style="list-style-type: none"> • The drain hose may be squashed or kinked. • The drain pump may be blocked. • The drain hose extension, if fitted, is not correct. Follow the instructions for connecting to the waste. • The drainage system pipes are blocked. <p>The wash load is unbalanced: redistribute the clothes inside the drum to allow the machine to spin.</p> <ul style="list-style-type: none"> • The RINSE HOLD option has been selected.
There is water on the floor	<ul style="list-style-type: none"> • Too much detergent or unsuitable detergent has been used (creates too much foam). • Check whether there are any leaks from one of the inlet hose(s) fittings. It is not always easy to see this as the water runs down the hose; check to see if it is damp. • The drain hose may be damaged or not securely positioned. • The detergent dispenser drawer or recess is clogged. • The drainage system pipes are blocked.
Unsatisfactory washing results	<ul style="list-style-type: none"> • Too little detergent or unsuitable detergent has been used. An insufficient amount of detergent leaves the laundry looking grey and causes lime scale to form. • Stubborn stains have not been treated prior to washing • The correct wash programme has not been selected. • Too much laundry has been placed in the drum.
The machine vibrates when spinning	<ul style="list-style-type: none"> • The internal packing has not been removed. • The machine is in contact with the wall or furniture. • The machine is not stable and level (check diagonally). • The washing load is badly distributed in the drum. • Maybe there is very little laundry in the drum.

Symptom	Possible causes
The door will not open	<ul style="list-style-type: none"> • The programme is still running. • The door lock has not yet released. • Water in the tub: the door cannot be opened if water is present in the tub.
Spinning starts late or the machine does not spin	<ul style="list-style-type: none"> • The electronic unbalance detection device has cut in because the laundry is not evenly distributed in the drum. The laundry is redistributed by reverse rotation of the drum. This may happen several times before the unbalance disappears and normal spinning can resume. If, after 10 minutes, the laundry is still not evenly distributed in the drum, the machine will not spin. In this case, redistribute the load manually and reselect the spin programme.
The machine makes an unusual noise	<ul style="list-style-type: none"> • The machine is fitted with a type of motor which makes an unusual noise compared with other traditional motors. This new motor ensures a softer start and more even distribution of the laundry in the drum when spinning, as well as increased stability of the machine.
No water is visible in the drum	<ul style="list-style-type: none"> • Machines based on modern technology operate very economically using very little water without affecting performance.

If after the above checks, there is still a fault, call your local Bendix Service Force Centre.

Service & Spare Parts

If you require an engineer or wish to purchase spare parts contact your local Bendix Service Force Centre by telephoning:

08705 929929

Your telephone call will be routed to the Service Centre covering your post code area.

For the address of your local Service Force Centre and further information about Service Force please visit the website at www.serviceforce.co.uk

When you call the Service Force centre please make sure you give the model and serial number of the appliance.

This information can be found on the rating plate (see picture).

In-guarantee customers should ensure that the above checks have been made as the engineer will make a charge if the fault is not a mechanical or electrical breakdown. Please note that proof of purchase is required for any in-guarantee service calls.

Customer care

For general enquiries concerning your Bendix appliance or for further information on Bendix products, please contact our Customer Care Department by letter or telephone as follows:

Customer Care Department

Bendix

55-77 High Street

Slough

Berkshire

SL1 1DZ

Tel 08705 950950 *

* Calls to this number may be recorded for training purposes

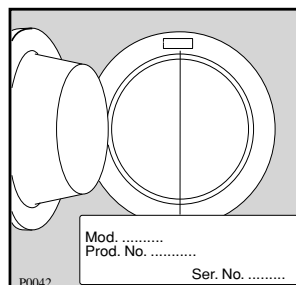

Guarantee Conditions

Standard guarantee conditions

This guarantee is in addition to your statutory and other legal rights.

We, Bendix, undertake that if, within 12 months of the date of the purchase, this BENDIX appliance or any part thereof is proved to be defective by reason only of faulty workmanship or materials, we will, at our option, repair or replace the same **FREE OF ANY CHARGE** for labour, materials or carriage on condition that:

- The appliance has been installed correctly and used only on the electricity supply stated on the rating plate.
- The appliance has been used for normal domestic purposes only, and in accordance with the manufacturer's operating and maintenance instructions.
- The appliance has not been serviced, maintained, repaired, taken apart or tampered with, by any person not authorised by us.
- All service work under this guarantee must be undertaken by a Bendix service representative or authorised agent

Any appliance or defective part replaced shall become our property.

Home visits are made between **8.30am** and **5.30pm** Monday to Friday. Visits may be available outside these hours in which case a **charge** will be made.

Exclusions

This guarantee does not cover:

- Damage or calls resulting from transportation, improper use or neglect, the replacement of any light bulbs or removable parts of glass or plastic.
- Costs incurred for calls to put right an appliance which is improperly installed or calls to appliances outside the United Kingdom.
- Appliances found to be in use within a commercial environment, plus those which are subject to rental agreements.
- Products of Bendix manufacture which are NOT marketed by Bendix.

European guarantee

If you should move to another country within Europe then your guarantee moves with you to your new home subject to the following qualifications:

- The guarantee starts from the date you first purchased your product
- The guarantee is for the same period and to the same extent for labour and parts as exists in the new country of use for this brand or range of products
- This guarantee relates to you and cannot be transferred to another user
- Your new home is within the European Community (EC) or European Free Trade Area
- The product is installed and used in accordance with our instructions and is only used domestically, i.e. a normal household

Before you move please contact your nearest Customer Care Centre, listed below, to give them details of your new home. They will then ensure that the local Service Organisation is aware of your move and able to look after you and your appliances.

France	Senlis	+33 (0)3 44 62 28 28
Germany	Nurnberg	+49 (0)911 323 2600
Italy	Pordenone	+39 (0) 1678 47053
Sweden	Stockholm	+46 (0)20 78 77 50
UK	Slough	+44 (0)1753 219 898

Installation Instructions

- ⚠ It is dangerous to alter the specifications or attempt to modify this product in any way.
- ⚠ Care must be taken to ensure that the appliance does not stand on the electrical supply cable.
- ⚠ Any electrical work required to install this appliance should be carried out by a qualified electrician or competent person.
- ⚠ Any plumbing work required to install this appliance should be carried out by a qualified plumber or competent person.
- ⚠ Should the appliance power supply cable need to be replaced, this should be carried out by our Service Force Centre.

Technical Specifications

DIMENSIONS	Height Width Depth	85 cm 60 cm 60 cm
POWER SUPPLY VOLTAGE TOTAL POWER ABSORBED		230-240 V/50 Hz 2100 W (10A)
WATER PRESSURE	Minimum (cold) Minimum (hot) Maximum	5 N/cm ² (7 psi) 3 N/cm ² (4 psi) 80 N/cm ² (110 psi)
MAXIMUM RECOMMENDED LOAD	Cotton, linen Synthetics Delicate fabrics Wool	4.5 kg 2 kg 2 kg 1 kg
SPIN SPEED	Maximum	1000 rpm
CONSUMPTION DATA FOR WASHING 4.5 KG NORMALLY SOILED COTTON ITEMS AT 60°C (PROGR. 3) WITH COLD WATER FILLING	Energy Water	0,85 KWh 56 litres

- CE** This appliance complies with the following E.E.C. Directives:
- 73/23 EEC of 19.2.73 (Low Voltage Directive) and subsequent modifications;
 - 89/336 EEC of 3.5.89 (Electromagnetic Compatibility Directive) and subsequent modifications.

Unpacking

⚠ All transit bolts and packing must be removed before using the appliance

You are advised to keep all the packaging for re-use in case the appliance has to be transported again.

- Unscrew and remove the three rear transit bolts (using a spanner).

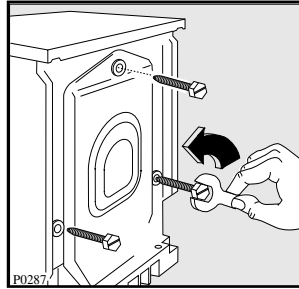

- Lay the machine gently on its back, making sure that the hoses are not squashed.

We suggest a polystyrene angle bracket from the packing is placed on the floor before tilting it back to avoid the hoses being squashed.

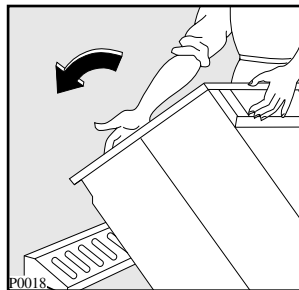

- Carefully remove the polyethylene bags located at the base of the machine by pulling them toward the centre of the machine.

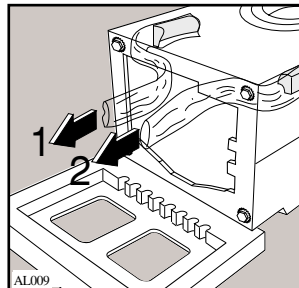

- Place the machine in an upright position and remove the three plastic spacers.

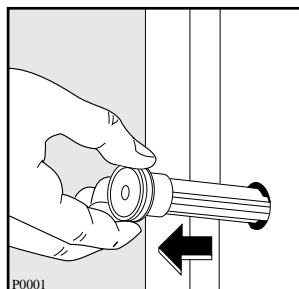

- Plug the 3 holes with the plastic plugs which you can find in the envelope containing the instruction booklet.

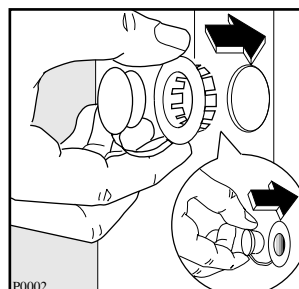

Important !

You are advised to keep all the packaging for re-use in case the machine is to be transported again.

If the appliance is to be moved, the precautions listed under **The dangers of freezing** must be carried out i.e. the residual water in the hoses must be pumped out.

Positioning

Install the machine on a flat hard floor.

Make sure that air circulation around the machine is not impeded by carpets, rugs etc. Check that the machine does not touch the wall or other kitchen units.

Never place cardboard, wood or similar materials under the machine to compensate for any unevenness in the floor.

Your new washing machine has been designed to be permanently plumbed in to your home's water supply and drainage system. However, if this is not possible, it may be connected to suitable existing taps with the drain hose discharging into a sink.

The appliance has two inlet hoses, hot and cold, with female 3/4 BSP thread connectors. If this connection is not compatible with the plumbing of the existing installation, a variety of connectors are available from good hardware stores and plumbers merchants to suit most domestic plumbing. Any alteration to your existing plumbing must be carried out by a competent person, or qualified plumber.

Installation on a Suspended Floor

Suspended wooden floors are particularly susceptible to vibration. To help prevent vibration we recommend you place a waterproof wood panel, at least 15 mm thick under the appliance, secured to at least 2 floor beams with screws. If possible install the appliance in one of the corners of the room, where the floor is more stable.

Water inlet

The inlets on the back of the appliance are colour coded, blue for cold and red for hot.

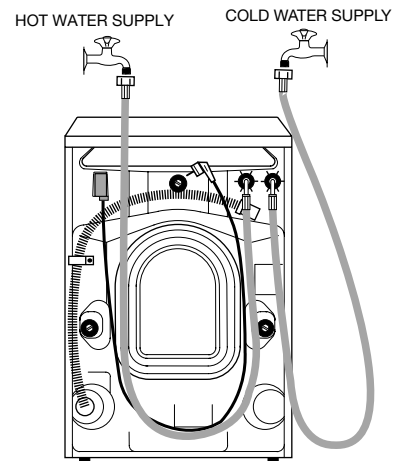

Connect the hoses to a tap with a 3/4 thread.

Do not use already employed inlet hoses.

If only a cold water supply is available, connect the two hoses to a cold water outlet by means of a 'Y' connection piece.

Installation should comply with local water authority and building regulations requirements.

The appliance must be given a separate cold water supply and not be connected to a mixer tap, a single outlet water heater or a booster pump. A minimum water pressure of 0.48 bar is required for safe operation of the appliance.

If you cannot make the cold water connection direct from the rising mains, you may be able to operate the appliance from your cold water storage system.

There should be a minimum distance of 5.02m (16.5 ft) between the appliance's inlet and the bottom of the water storage tank.

There will be sufficient pressure for the hot water supply, providing there is a minimum height of 2.74 metres (9 ft) between the bottom of the cold water storage tank and the bottom of the hot water cylinder.

Set the hoses correctly by loosening the ring nuts. After positioning the inlet hoses, be sure to tighten the ring nuts again to prevent leaks.

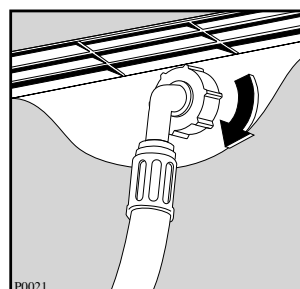

Water drainage

This appliance is designed to be permanently plumbed into your home's water supply and drainage system.

The appliance drain hose should hook into a standpipe, the hook in the drain hose is formed using the plastic U-Piece supplied.

The standpipe should have an internal diameter of approximately 38mm (see diagram) thus ensuring there is an air break between the drain hose and standpipe.

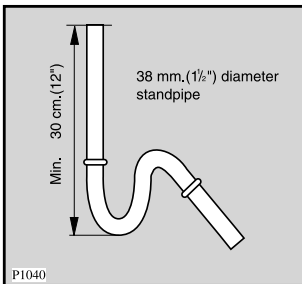

When discharging into a standpipe ensure that the top of the curve in the hose end is no more than 90cm (35.4 inches) and no less than 60cm (23.6 inches) above floor level. The upright standpipe should have a minimum length of 30cm (12 inches) from the bottom of the elbow to the top of the pipe (see diagram).

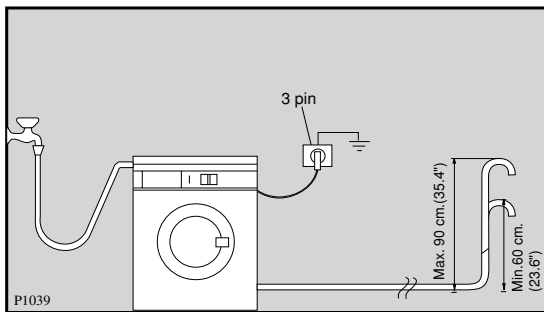

Make sure that it is designed in such a way, that the end of the drain hose cannot be covered with water.

The drain hose may be extended to a maximum of 4 metres. An additional drain hose and joining piece is available from your local Service Force Centre. The joining piece must have an internal diameter of 18mm.

If you intend the drain hose to empty into a sink, make sure that the sink is empty and the plug hole is not blocked. Use the plastic U-Piece supplied.

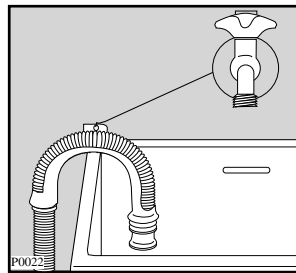

The drain hose must not be kinked.

Important

- Before connecting up the machine to new pipework or to pipework that has not been used for some time, run off a reasonable amount of water to flush out any debris that may have collected in the pipes.
- For a correct functioning of the machine the drain hose must be hooked on the proper support piece situated on the top of the back side of the appliance.

Levelling

Level the washing machine by loosening or tightening the feet. Once in the right position fix the feet by pushing the nuts against the base of the case.

Accurate levelling prevents vibration, noise and displacement of the machine during operation. After levelling the machine, secure the feet by tightening the ring nuts with the aid of a screwdriver.

Some vibration is inevitable, especially if mounted on a wooden floor.

Sprung wooden floors are particularly susceptible to vibration. For advice, consult a builder. If possible, always place the machine on a solid floor.

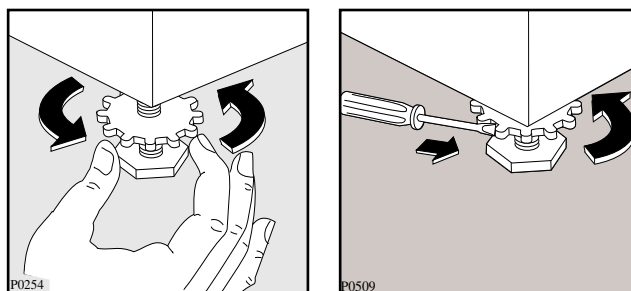

Special conditions

If the floor is carpeted with a deep-pile carpet or covered with crumbly or soft material, insert a rigid support base under the feet to prevent noise, vibration or displacement. The base should protrude a few centimetres beyond the edges of the machine.



Warning

The machine should NOT be placed on deep pile carpeting.

Note

Please ensure that when the appliance is installed it is easily accessible for the engineer in the event of a breakdown.

In the interest of the environment

Washing machines and dishwashers should be connected to the FOUL drainage system, the water will then be taken to a sewage works for treatment before being discharged safely into a river.

It is essential that these appliances are not connected to the surface water drainage system as this water is discharged directly into a river or stream and may cause pollution.

If you require any further advice please contact your local authority drainage department.

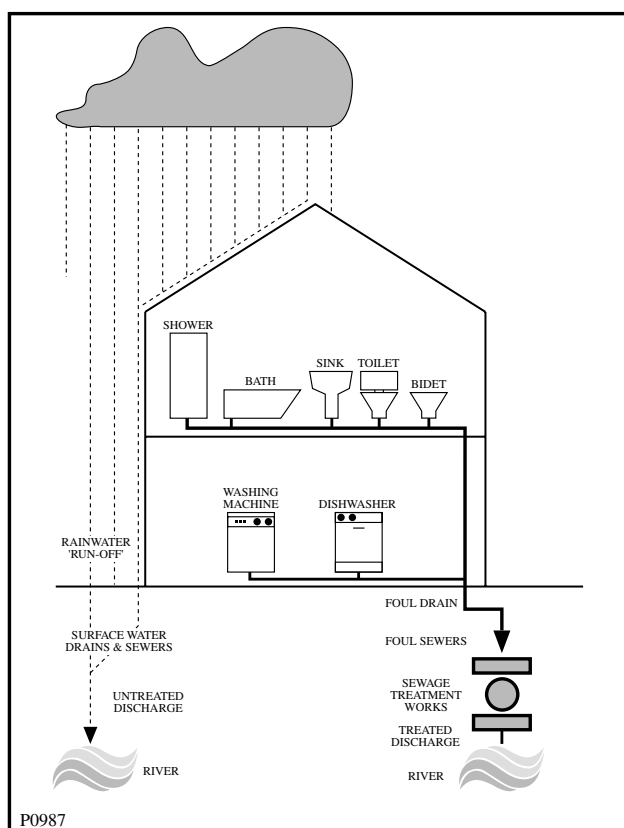

Electrical connections

Any electrical work required to install this appliance should be carried out by a qualified electrician or competent person

WARNING: THIS APPLIANCE MUST BE EARTHED.



The manufacturer declines any liability should this safety measure not be observed.

Before switching on, make sure the electricity supply voltage is the same as that indicated on the appliance rating plate (the plate is adhered to the rear of the appliance).

The appliance is supplied with a 13 amp plug fitted. In the event of having to change the fuse in the plug supplied, use a 13 Amp BS1362 fuse. Only ASTA or BSI approved fuses must be used.

Should the plug need to be replaced for any reason, proceed as described below.

The wires in the mains lead are coloured in accordance with the following code:

Green and Yellow	- Earth
Blue	- Neutral
Brown	- Live

Connect the green and yellow (earth) wire to the terminal in the plug which is marked with the letter «E» or the earth symbol \perp or coloured green and yellow.

Connect the blue (neutral) wire to the terminal in the plug which is marked with the letter «N» or coloured black.

Connect the brown (live) wire to the terminal in the plug which is marked with the letter «L» or coloured red.

The plug must not be used if the fuse cover/carrier is lost. The cover/carrier is indicated by the coloured insert at the base of the plug.

A replacement cover/carrier must be obtained from your local Bendix Service Centre.

WARNING: a cut off plug inserted into a 13 amp socket is a serious safety (shock) hazard.



Ensure that the cut off plug is disposed of safely.

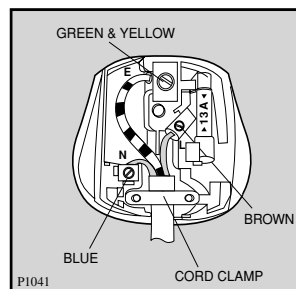

Permanent connection

In the case of permanent connection it is necessary that you install a double pole switch between the appliance and the electricity supply (mains), with a minimum gap of 3 mm between the switch contacts and of a type suitable for the required load in compliance with the current electrical regulations.

The switch must not break the yellow and green earth cable at any point.



Bendix, 55-77 High Street, Slough, Berkshire SL1 1DZ

Consumer care telephone number 08705 950 950

The Electrolux Group is the world's largest producer of powered appliances for kitchen, cleaning and outdoor use. More than 55 million Electrolux Group products (such as refrigerators, cookers, vacuum cleaners, chain saws and lawn mowers) are sold each year to a value of approx. 14 billion USD in more than 150 countries around the world.

 ***From the Electrolux Group. The world's No.1 choice.***