Washing Machine

Thank you for your trust and for buying this appliance.
We hope it will successfully serve its purpose for many years.

This washing machine was designed for home use.

It meets all the requirements of modern washing: it is economical, it uses less water, less energy and washing agent.

Before Use	52	Washing	60
Tips for Energy Savings		Control Light	
Important	53	Programme Selection Knob	
Removing the Transport Brackets	54	Temperature Selection Knob	
Placing and Installation	55	Spinning-OFF Knob	
Connection to the Water Supply		Pump Stop Pushbutton	
Water Outlet		Extra Rinsing Switch	
Connection to Power Supply		Higher water level pushbutton	
The Door	56	Half Programme Switch	
Direction of Opening the Door		Cold Wash - Switch	
Preparing the Laundry	57	ON/OFF switch	
Type of Fabrics		Prepare your machine for washing	
Colour Fastness		After Washing	
Degree of Soil		Table of Washing Programmes - Cold Water	
Loading		Table of Washing Programmes - Hot/cold Water	
Washing Agents and How Much to Use	58	Cleaning and Maintenance	64
Dispenser		Housing	
Fabric Conditioner and Starching Agent		Interior of the drum	
Liquid Washing Agents		Dispenser	
		Wire Net in the Inlet Hose	
		Door Gasket	
		Filter	
		Trouble Shooting Guide	66

i Before Use

This instruction manual was prepared for the user of the washing machine. Read the manual carefully and get to know your washing machine so that you will know how to use it safely and correctly.

This instruction manual was prepared for various models of washing machine, and they vary in function and design. Make sure to consider only those switches and knobs your machine is equipped with.

- When you find your appliance is out of use and no longer needed, try not to burden the environment with it. Call your nearest authorized "collecting service for used appliances".

Tips for Energy Savings

Through correct use and considering our recommendations, you can make substantial energy savings.

For economical washing, always refer to the table of programmes with recommended wash loads.

- Skip the pre-wash whenever possible (if laundry is lightly soiled).
- Laundry which was usually washed at 95°C may be washed at 60°C when using either the TAED washing agent (bleaching agent activator) or concentrated washing agents (any of the ...SUPER or ...ULTRA).
- Use an adequate washing agent, and always consider the recommended amount, and pay attention to water hardness and degree of soiling.
- In the course of time (depending on water hardness) lime deposits on the heater and inside the appliance. This increases the consumption of energy for heating water. Occasionally remove the lime deposit with a special agent.

Important

Before putting the machine into use, don't forget to remove the transport brackets. Switching on a blocked machine may damage the machine. Our guarantee does not cover such damage.

- Before switching the machine on, check that the transport brackets has been removed.
 - Don't place the appliance in a room where the temperature may fall below 0°C, causing individual parts of the machine to freeze and become damaged (hose may crack).
 - The appliance should stand firmly and horizontally on a solid base (a machine standing on an uneven floor is very likely to vibrate during the spinning cycle).
 - Always consider the instructions for correct placing and installation of the machine to the mains and water supply. This will help you avoid accidents and protect your machine against damage.
 - The appliance is to be connected to the water mains using new hose-sets and that old hose-sets should not be reused.
 - **The appliance may not be built-in under the kitchen worktop in a row of cabinets, because the use of the appliance without the top cover is not allowed for safety reasons. Likewise, the removal of the rear panel and the bottom of the appliance are also not allowed.**
 - The appliance should be positioned in such way to provide normal ventilation.
 - The end of the outlet hose should not be immersed in the discharge water (the machine may pump the discharge water back).
 - During the washing cycle, the door of the machine cannot be opened. It can only be opened 2 minutes after washing is finished.
 - The glass door gets very hot during washing, so take care of children.
 - Use only washing powder and other agents specially designed for machine washing.
We do not take any responsibility for damage caused by the improper use of bleaching or colouring agents (coloured gasket and other plastic parts).
 - Lime dissolving agents contain acid, so only use those containing rust-protection agents. Always consider the manufacturer's instructions. When you have finished removing lime deposit, run a few rinse cycles to make sure that the acid is thoroughly rinsed. Even traces of acid can cause substantial damage to component parts.
 - Never use washing agents containing solvents - individual component parts may be damaged or toxic gases may be produced. There is also a risk of ignition or explosion.
- When washing is finished, remember to close the tap.
 - Your washing machine can only be transported with transport brackets. It is usually enough to use only one of the rods, that is the upper one. It is much easier to insert the rod if you remove the top cover. Before doing anything, however, don't forget to disconnect the machine from the power supply.
 - Data plate with essential information on the appliance is fitted above the opening for laundry insertion under the door frame.

Removing the Transport Brackets

The washing assembly is blocked with two metal rods which protect the machine during transport (fig.1).

- Undo the screws on the rear wall (fig. 2).
- Remove the squares, rotate them 180° and use them to pull out the rods (fig. 3).
- Disengaged parts may remain at the bottom since they do not obstruct the operation of the machine (4 rubber hoses and 4 paper spools).
- Use the enclosed plastic caps to plug the holes (fig. 4).

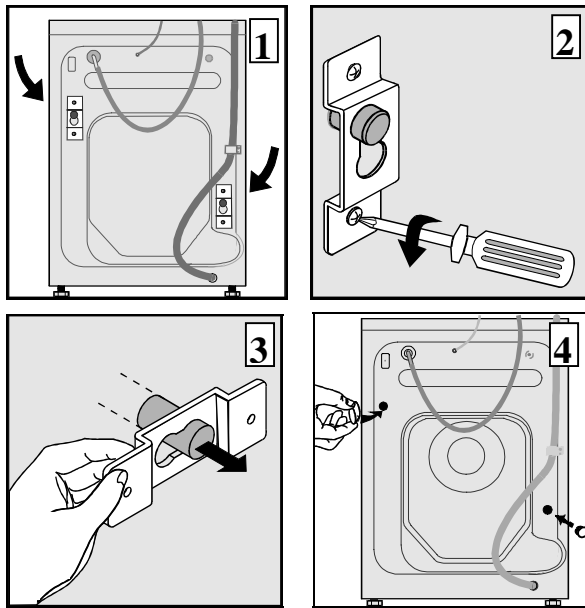

Save the brackets: you may need them later.

Placing and Installation

If the floor is uneven, use the adjustable feet to level the machine.

- Undo the nuts. Rotate the feet to level the machine (fig. 5).
- Fix the nuts (fig. 5.1).

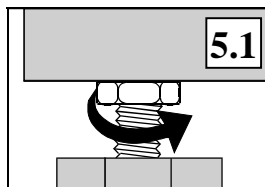
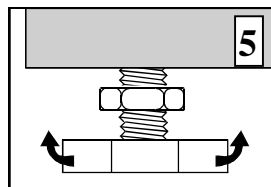

Maximum height of the washing machine is 850 mm.

IMPORTANT

The floor on which the machine stands should be dry, otherwise the machine may slide during the spinning cycle.

Connection to the Water Supply

The elbow connection of the inlet hose is fixed to the coupling on the rear wall of the appliance.

Insert a rubber washer with a net (filter) into a nut on the other end of the hose, and fix the hose to a tap. To ensure efficient operation, the water pressure of the water supply should be between 0.5 and 8.0 bars.

If the pressure exceeds the maximum allowed limit, fit a pressure regulator. (Open the tap fully - in 15 seconds, 3 litres of water should pour out; and this is the minimum pressure of the water supply).

Connection to cold water

Insert the enclosed washer with filter into the loose end of the hose and connect the hose to water tap (fig. 6).

Connection to hot/cold water

Washing machines designed for the connection to hot/cold water are equipped with two inlet hoses. The attachment and the inlet hose for hot water are marked with red colour.

Insert the enclosed washers with filter into the loose ends of the hoses and connect the red marked hose to hot water tap and the other hose to cold water tap (fig. 6.1).

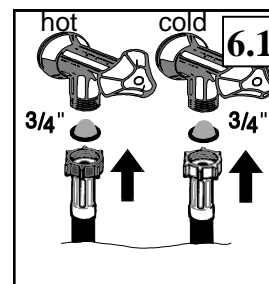
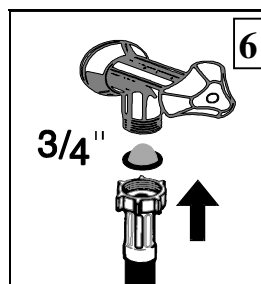

IMPORTANT

The highest allowed temperature of hot water is 60°C.

Water Outlet

Hook the outlet hose securely over the edge of the washbasin or bath tub. The outlet hose can also be connected directly to the plumbing outlet, the diameter of which should be not less than 4 cm (fig. 7).

Wall siphon drain must be correctly fitted in such manner to enable cleaning.

If water is drained through a washbasin, always check it is drained quickly enough, otherwise an overflow may occur or the machine may pump the water back. Pull a string through the hole on the plastic knee, and secure the outlet hose to prevent it from falling off (fig. 8).

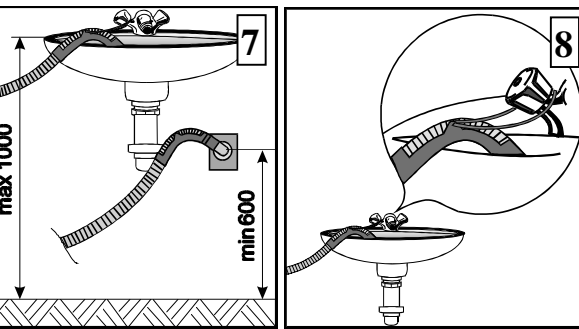
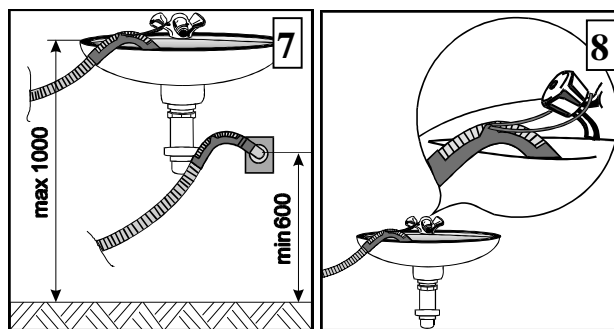

The end of the outlet hose should be raised from the floor by not more than 100 cm and not less than 60 cm. If the hose is positioned higher than recommended, the machine will not pump out the water.

Connection to Power Supply

Connect the appliance to the power supply with a cable cord. The wall socket should be equipped with an earth contact (safety socket).

Fixed connection should be carried out by an expert.

Rated voltage, frequency and other data are listed on the rating plate of the machine.

Your washing machine should be grounded and connected to the power supply according to local electricity board regulations and standards.

WARNING!

In the **supply cord** is damaged, it must be replaced by the manufacturer or his service agent or a qualified person in order to avoid hazard.

- The appliance should be placed in the position, where the plug is within reach.

The Door

The door can only be opened two minutes after the washing programme has finished.

Open the door by pulling the door handle (fig. 9).

When closing the door, push it towards the machine until it locks (fig. 10).

If the door is not correctly closed, the machine will not operate.

Direction of Opening the Door

Certain models of appliances allow the possibility of changing the direction of door opening. This is an option that has to be ordered separately and paid for by the customer.

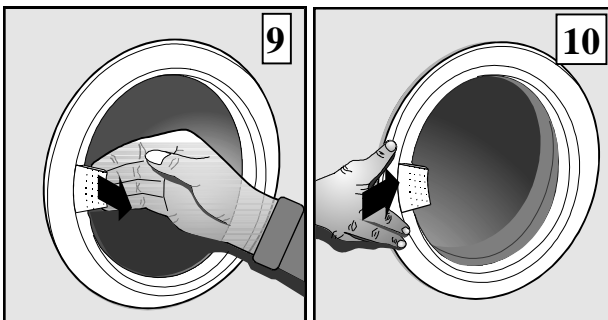

IMPORTANT

- When closing the door, be careful not to trap fabric between the door glass and the rubber gasket.
- If you need to open the door after the machine has been switched on, first switch it off and wait for about two minutes.
When opening the door, be careful, as the water level may be high and water may pour out when you open the door.
- Don't even try to open the door while the machine is operating.
- If the machine won't start after switching on, push the door once again towards the machine (at handle).
- An inadequately closed door is the most common cause of malfunctions.

Preparing the Laundry

Sort the laundry before washing according to the type, quality, colour and soil degree of the laundry.

Type of Fabrics

Most clothes nowadays have labels describing the type of fabric they are made of, the kind of recommended wash, and the recommended washing temperature.

These labels will help you choose the most suitable washing programme for your clothes.

Put delicate laundry (stockings, fine underwear...) into a sack or into a pillow case if washed together with other laundry.

°C	WASHING
95°	White laundry - resistant.
80° 40° 30°	Coloured laundry - resistant
80° 40° 30°	Fine and delicate laundry
	Hand wash.
	No washing.
	DRY CLEANING
	Dry cleaning.
	Dry cleaning not allowed.
	DRYING
	Drying in tumble drier allowed.
	Higher temperature (resistant laundry)
	Lower temperature (delicate laundry)
	Drying in tumble drier not allowed.
	IRONING
	Ironing: up to 200°C - up to 150°C - up to 110°C
	No ironing

Colour Fastness

Pay special attention to colour fastness, and always choose the correct washing temperature. When washing new clothes, always check colour fastness first - wash separately the first time.

Degree of Soil

Stained and heavily soiled laundry should be washed in small loads or with a larger amount of washing powder.

Heavily stained or soiled areas on the fabric can be treated before washing using special agents.

Use the energy-saving programme for lightly soiled laundry (no pre-wash, economic programme, lower washing temperature).

Loading

The maximum load of dry laundry is stated in the table.

Excessive loads cause creases and decrease the washing effect.

Always check the pockets before loading the laundry. Remove keys, coins, hair-pins and similar objects that may clog the water outlet hose.

Zip the zippers and remove metal pins that may damage the laundry or even the drum (fig. 11).

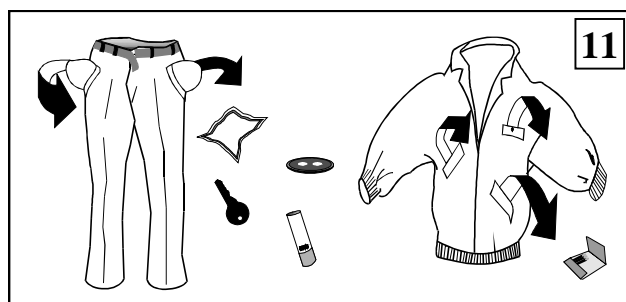

Folded clothes should be loosened before loading.

The best washing effect is obtained by mixing larger and smaller items of laundry in one load.

Washing Agents and How Much to Use

Use only washing powder for machine washing. Use special washing agents for delicate and woollen fabrics.



This washing machine was designed for washing powder as well as for liquid detergent. As to the quantity of the washing agent, refer to the manufacturer's recommendation. The quantity of washing agent recommended on the packaging is usually sufficient for 4.5 to 5 kg of normally soiled laundry, depending on the hardness degree.

Hardness degrees (Water hardness)	Degrees of hardness			
	°dH(°N)	m mol/l	°fH(°F)	p.p.m.
(soft)	0-7	0-1,3	0-12	0-120
(medium)	7-14	1,3-2,5	12-25	120-250
(hard)	14-21	2,5-3,8	25-37	250-370
(wery hard)	>21	>3,8	>37	>370

If your water is hard, we recommend using water softener. This means that you can then use the same quantity of washing powder as if the water was soft (hardness degree 1). Follow manufacturer's instruction.

Dispenser

The detergent dispenser is divided into three sections (fig. 12). The table of the programme shows which section to use.

	These sections are used for washing powder
	This section is used for fabric conditioner and starching agent.

Always add washing agents before switching on and keep the dispenser clean and dry, so that the washing agent can be efficiently rinsed from the ispenser.

With programmes without a pre-wash cycle, the washing powder can be put directly in the drum. This is especially convenient if:

- you use larger amounts of washing powder (very hard water),
- you use washing powder which is hard to rinse from the dispenser,
- water pressure is low,
- you use a concentrated washing powder special dosing sack which should be inserted directly in the drum.

Not enough washing powder causes

- the laundry to turn grey,
- greasy clots,
- lime deposit in the machine and on the laundry.

Too much washing powder causes

- bubbling,
- reduced agitation and washing effect,
- inadequate rinsing.

We recommend that you gradually decrease or increase the quantity of washing agent and at the same time pay attention to the linen.

Fabric Conditioner and Starching Agent

When using fabric conditioner or starching agent, always follow the manufacturer's instructions, but never fill higher than the level marked on the dispenser. The excess is immediately poured out before washing and is therefore pure waste.

When using the high density liquid agent we recommend mixing it with water before filling, as otherwise the dispenser outlet may clog.

In case the dispenser is clogged and the liquid is not flushed, the dispenser should be washed. Remove level indicator and wash with brush and lukewarm water or rinse under the tap (fig. 13).

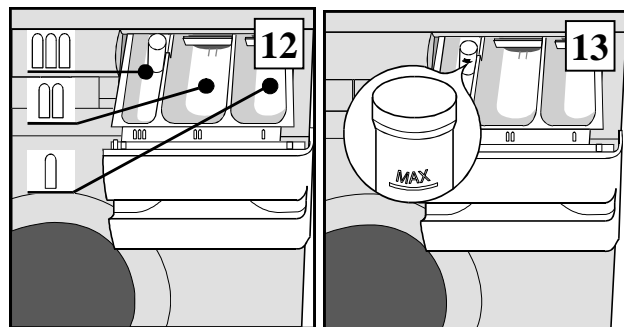

Never use both fabric conditioner and starching agent together, as clots may clog the dispenser opening.

Liquid Washing Agents

(for some models only)

If the washing machine is equipped with partition plate, the middle section may also be used for liquid washing agents.

Lift the partition plate when using washing powders and push it in when using liquid detergent.

We recommend using liquid detergent with washing programme without prewash.

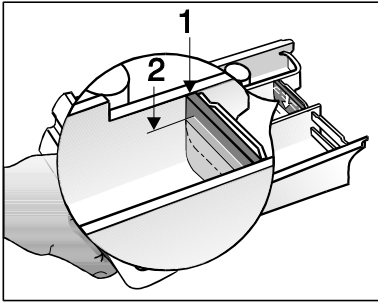

1. Washing powder
2. Liquid detergent

Washing

Before washing, select the washing programme and prepare the machine for washing.

The control panel incorporates various switches and pushbuttons for selecting washing programmes, a control light, and a dispenser.

This instruction manual was prepared for various models of washing machine. You may therefore find in it descriptions of some functions that your appliance doesn't have.

Control Light

Control light is lit when the machine is switched on.

Programme Selection Knob

When the machine is switched off, turn the knob clockwise.

Washing programmes are divided into three groups and are marked with letters (A knob).

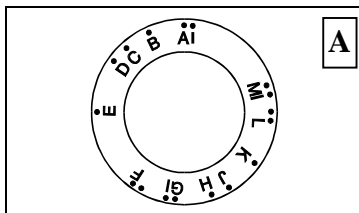
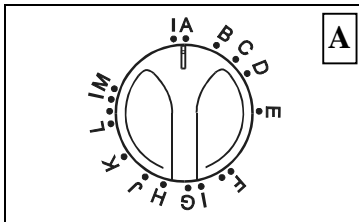

Programmes for non-delicates (A-F)

Programmes are intensive and concluded with 6-minutes spin cycle.

Programmes for delicates (G-L)

Programmes with gentle tumbling and are concluded with short spin cycle (2 minutes).

Programme for Woolens (M)

Programme for woolens may as well be used for washing delicates and specials. Laundry is washed with higher water level and gentle tumbling. The programme is concluded with 2 minutes spin cycle.

Spinning with interruptions

(only for models with 800 rpm. or more)

On programmes for resistant laundry the first two spinning cycles are three times interrupted at the beginning. This prevents excessive foaming of the washing powder and improves spinning results.

Temperature Selection Knob

Turn the knob clockwise (B knob).

Washing temperature may be optionally selected up to 95°.

Programmes from A to B may be used as economic programme, if the selected temperature is lower than 95°C. This feature will help you save energy up to 40%.

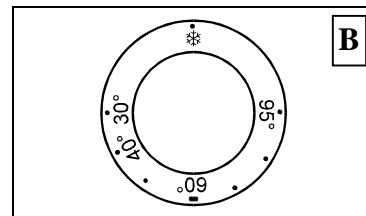
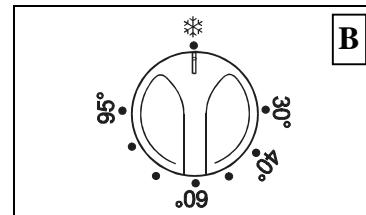

On the position marked with a snow flake, the heaters are switched off and you can select cold wash on all programmes. The duration of the programme is the same as if the heaters are on.

Spinning-OFF Knob



Switch the spinning-OFF knob, if you want either:

- to switch off the spin cycle on all the programmes for delicates and woolens; or
- the programmes for delicates to rinse without spinning and with short end spin cycle (2 minutes).

Pump Stop Pushbutton



Use this switch for all programmes, except for programmes for woolens, if you want your laundry to remain in the last rinsing water.

When this pushbutton is off, the washing programme end with spin cycle.

Extra Rinsing Switch



All washing programmes are designed for the optimum use of water, during the washing as well as during the rinsing cycle.

Use the extra rinsing cycle if you are allergic to washing agents. The switch may be pressed either before washing or before rinsing.

Higher water level pushbutton



Washing under programmes for resistant laundry (programmes A and B) is carried out with a low water level, the quantity of water is automatically adjusted to the amount of laundry. This guarantees successful and economic washing, regardless of the amount of laundry.

When you are washing laundry that is heavily soiled or stained, press this pushbutton for a higher water level for the pre-wash and the main wash.

It is impossible to change the water level in programmes for delicate linens and woolens.

Half Programme Switch

1/2 If the amount of laundry you intend to wash is smaller, use the half programme (up to 2.5 kg).

This will help you save energy and water. Don't forget to use less washing powder as well.

Washing machine without temperature selection knob

Half programme switch may be used only with programmes for non-delicates (95°C).

If you use the half programme switch for other programmes, the washing temperature will be higher than marked for individual programme.

Washing machine with temperature selection knob

Half programme switch may be used with all programmes for non-delicates. On programmes for delicates and woolens, this switch won't work.

Cold Wash - Switch



If you switch the cold wash switch, the heaters are off and all programmes are washing with cold water. The duration of the programme is the same as if the heaters were on.

ON/OFF switch



Select suitable washing programme, prepare the laundry for washing and press the ON/OFF switch to switch the machine on.

Prepare your machine for washing

- Select laundry and load a suitable amount.
- Close the door (push it towards the machine).
- Fill the dispenser (in the correct sections).
- Check water inlet and outlet.
- Choose the right programme.
- If your machine is equipped with switches, use them, as appropriate.
- Select the washing temperature, if your washing machine is equipped with this option.
- Switch the machine on.

After Washing

- Switch off the machine (the control lamp turns off).
- Check that the washing is finished and that water is pumped out of the machine to avoid unnecessary flooding. If there is still water in the machine, select one of the programmes for pumping or spinning.
- Some two minutes after the washing is finished you can open the door.
- Take the laundry out of the machine and turn the drum once or twice with hand to make sure it is really empty.
- Check the rubber gasket on the door and remove objects that might have deposited (buttons, pins..) (fig. 14).
- Leave the door open and allow the interior to dry.
- Disengage any pushbuttons you used.
- Close the water tap.
- Check the dispenser and clean it if necessary and dry it well.
- Every now and then, check and clean the lint filter.

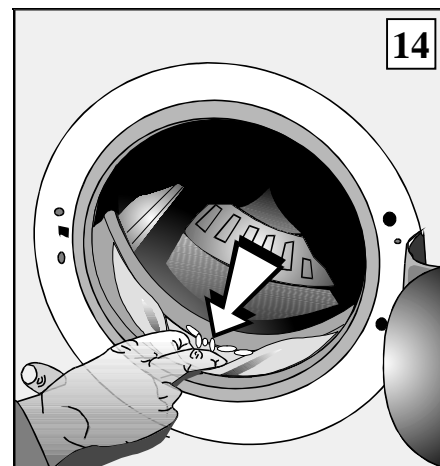





Table of Washing Programmes - Cold Water



Programme		Washing temperature (°C)		Dispenser-washing agents	Dry laundry (kg)			
A ⋮ M	Type of fabric, laundry	①	②					
NON-DELICATES (cotton, linen)								
	A B	Whites/Coloureds	95	40 - 95	<input type="checkbox"/>	<input type="checkbox"/>	<input type="checkbox"/>	5,0
			95	*40 - 95	<input type="checkbox"/>	<input type="checkbox"/>	<input type="checkbox"/>	
	C D	Coloureds	*60	40 - 60	<input type="checkbox"/>	<input type="checkbox"/>	<input type="checkbox"/>	
			40	❄ - 40	<input type="checkbox"/>	<input type="checkbox"/>	<input type="checkbox"/>	
	E	Rinse			<input type="checkbox"/>	<input type="checkbox"/>	<input type="checkbox"/>	
	F	Conditioner, spin dry			<input type="checkbox"/>	<input type="checkbox"/>	<input type="checkbox"/>	
DELICATES (surface finished cotton, mixture of cotton with synthetics)								
	G H J	Delicates (surface finished), Fine delicates	60	❄ - 60	<input type="checkbox"/>	<input type="checkbox"/>	<input type="checkbox"/>	2,5
			60	*❄ - 60	<input type="checkbox"/>	<input type="checkbox"/>	<input type="checkbox"/>	
			*40	❄ - 40	<input type="checkbox"/>	<input type="checkbox"/>	<input type="checkbox"/>	
	K	Rinse			<input type="checkbox"/>	<input type="checkbox"/>	<input type="checkbox"/>	
	L	Conditioner, short spin			<input type="checkbox"/>	<input type="checkbox"/>	<input type="checkbox"/>	
WOOLEN (non-shrinkable, mixtures of wool with synthetics, silk)								
	M	Woolen	40	❄ - 40	<input type="checkbox"/>	<input type="checkbox"/>	<input type="checkbox"/>	1,0

Legend:

①	No temperature selection knob (washing temperature is determined with programme selection).
②	Models with temperature selection knob (recommended washing temperature).

* Programmes for testing according to EN 60456.

Table of Washing Programmes - Hot/cold Water

Programme		Washing temperature (°C)	Dispenser-washing agents	Dry laundry (kg)			
A ⋮ M	Type of fabric, laundry						
NON-DELICATES (cotton, linen)							
	A B	Whites/Coloureds	60 - 95	<input type="checkbox"/>	<input checked="" type="checkbox"/>	<input type="checkbox"/>	5,0
			60 - 95	<input type="checkbox"/>	<input checked="" type="checkbox"/>	<input type="checkbox"/>	
	C D	Coloureds	40 - 60	<input type="checkbox"/>	<input checked="" type="checkbox"/>	<input type="checkbox"/>	
			❄ - 40	<input type="checkbox"/>	<input type="checkbox"/>	<input type="checkbox"/>	
	E	Rinse		<input type="checkbox"/>	<input type="checkbox"/>	<input type="checkbox"/>	
	F	Conditioner, spin dry		<input type="checkbox"/>	<input type="checkbox"/>	<input type="checkbox"/>	
DELICATES (surface finished cotton, mixture of cotton with synthetics)							
	G H J	Delicates (surface finished), Fine delicates	40 - 60	<input type="checkbox"/>	<input checked="" type="checkbox"/>	<input type="checkbox"/>	2,5
			40 - 60	<input type="checkbox"/>	<input checked="" type="checkbox"/>	<input type="checkbox"/>	
			❄ - 40	<input type="checkbox"/>	<input type="checkbox"/>	<input type="checkbox"/>	
	K	Rinse		<input type="checkbox"/>	<input type="checkbox"/>	<input type="checkbox"/>	
	L	Conditioner, short spin		<input type="checkbox"/>	<input type="checkbox"/>	<input type="checkbox"/>	
WOOLEN (non-shrinkable, mixtures of wool with synthetics, silk)							
	M	Woolen	❄ - 40	<input type="checkbox"/>	<input type="checkbox"/>	<input type="checkbox"/>	1,0

Water:	Cold	Hot	Hot/Cold
---------------	-------------	------------	-----------------

Cleaning and Maintenance

Warning:

- Before cleaning disconnect the machine from mains supply.
- There is a danger of burning when hot water is in the machine. Wait until it cools.

Housing

Clean the housing of your washing machine with a soft cloth and mild detergent. Do not use coarse cleaning agents which could damage the surface.

Interior of the drum

Lumps of grease can occur in the inside of the drum, on the door seal as well as on clothes washed, which is due to incorrect washing procedure. Prior to next washing, clean the machine by setting the appliance to the programme whites/coloureds 60°C and do the washing without laundry using only half quantity of detergent or better a liquid washing agent.

Dispenser

Check the dispenser after each washing. If there is a residue of washing powder, clean it. Pull it out of the machine, clean it with a brush and warm water, and dry it (fig. 15).

If necessary clean the interior of the detergent dispenser casing, in case you detect the remainings of washing powder inside.

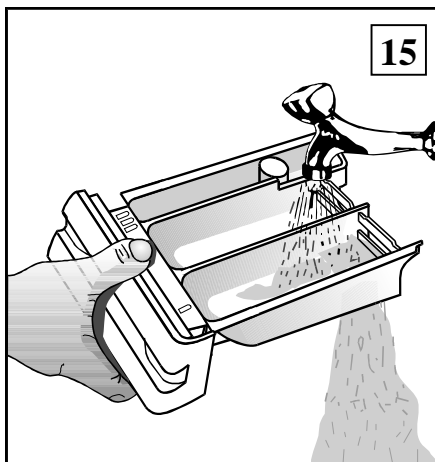

Wire Net in the Inlet Hose

The wire net in the inlet hose should be frequently cleaned.

Shut off the water supply and remove the inlet hose. Clean the net under a tap, replace it and fix the inlet hose (fig. 16).

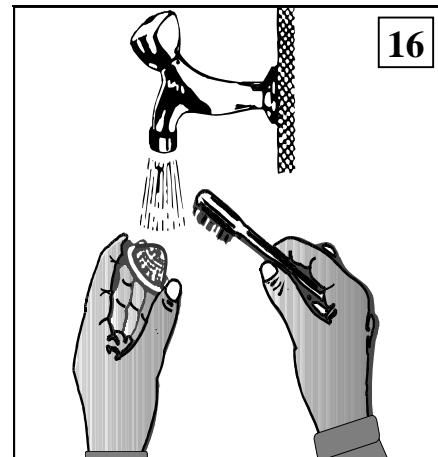

Door Gasket

Wipe the gasket after each washing; the gasket will last longer.

Filter

Filter is located under the cap at the bottom of the machine.

If you use the machine correctly, there is no need to clean the filter.

You have to open and clean the filter when solid objects trap in it and obstruct the outlet. (The laundry is not rinsed enough, still wet, water is not pumped out of the machine).

Before cleaning the filter, mind to pump the water out of the machine. The best method to do that is to place the outlet hose as low as possible (near the floor).

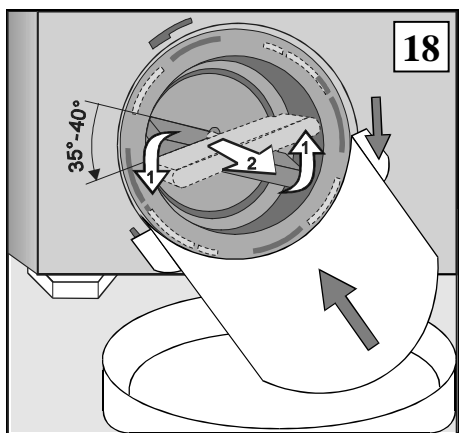
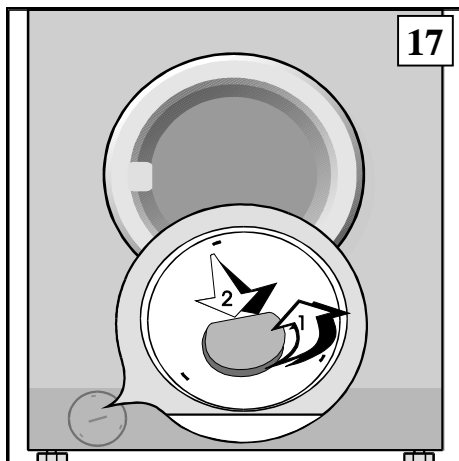

- Remove the cover (with coin inserted into the notch (fig. 17).
- Insert the funnel attached to the machine into the bottom cut-outs between the filter cover and cabinet and fix it by turning clockwise.
- Place a shallow pan underneath to allow the excess water to pour out. Remove the filter, by turning it counter-clockwise (35-40°) (fig. 18).
- Replace the filter in the reverse order and screw it down firmly. Check it for sealing prior to washing.

❓ Trouble Shooting Guide

The user can come across troubles appearing during the operation of the appliance. We are listing some of troubles, which in most cases

result from improper handling of the appliance and can be eliminated by yourself.

Problem:	Check the following:
The machine doesn't operate (the control lamp is off).	<ul style="list-style-type: none"> – Check the power supply and fuses. – Is the plug correctly plugged in the socket?
Water is not pumped into the machine.	<ul style="list-style-type: none"> – Is the machine switched on? – Is the water tap open? – Is the wire-net filter on the inlet hose clean? – Is the door well closed?
The machine jumps during operation.	<ul style="list-style-type: none"> – Are the transport brackets removed? – Is the machine correctly levelled? (if not, use the adjustable legs) – Check the load (perhaps you are washing only one large item).
The machine is leaking.	<ul style="list-style-type: none"> – Is the lint filter properly fixed? – Is the inlet hose properly secured to the tap and to the machine?
The laundry is too wet.	<ul style="list-style-type: none"> – Is the lint filter clean (free of solid particles)? – Check whether the wall siphon drain is clogged (clean it).
Too much bubbling during washing.	<ul style="list-style-type: none"> – Check the water hardness and/reduc the quantity of washing powder you are using.
Washing was not efficient (stains, greasy clots).	<ul style="list-style-type: none"> – Have you chosen the correct wash programme? Use larger quantities of washing powder for heavily soiled laundry, or wash smaller loads.
Laundry is not well rinsed (wash powder residues).	<ul style="list-style-type: none"> – Is the lint filter clean (free of solid particles)? – Perhaps you overloaded the machine (especially delicate fabrics) and used too much washing powder. – Check whether the wall siphon drain is clogged (clean it).

After you have considered all the above stated instructions and the malfunction still cannot be eliminated, call the nearest authorised service. Any claim or malfunction caused by improper installation or misuse is not covered by the guarantee. All repair costs shall be covered by the user.

WE RESERVE THE RIGHT TO ALTER THE SPECIFICATIONS WITH NO INFLUENCE ON THE OPERATION OF THE APPLIANCE. THIS INSTRUCTION MANUAL CAN NOT BE A REASON FOR CLAIM.