

**FULL ELECTRONIC
WASHING MACHINE
USER MANUAL**

THE CONTENTS

SECTION 1:BEFORE USING

- Safety warnings
- Recommendations

SECTION 2:INSTALLATION

- Removal of transportation screws
- Adjustment of feet
- Electrical connection
- Water supply connection
- Water drain connection

SECTION 3:TECHNICAL SPECIFICATIONS

SECTION 4:CONTROL PANEL

- Start/Pause button
- Function indicator lights
- Function buttons
- Program knob

SECTION 5:WASHING YOUR LAUNDRY

- Before washing
- Running the machine

SECTION 6:MAINTENANCE AND CLEANING

- Water inlet filters
- Pump filter
- Detergent drawer
- Siphon plug
- The cabinet
- The drum
- Remove of your machine from lime

SECTION 7: PRACTICAL INFORMATION

SECTION 8:AVOIDING MINOR FAULTS

SECTION 9:AUTOMATIC FAILURE DETECTION SYSTEM

SECTION 10:INTERNATIONAL WASHING SIGNS

SECTION 1:BEFORE USING

SAFETY WARNINGS

- Do not use a multiple socket or extension cord.
- Do not insert a plug with damaged or broken cord into the socket.
- If the cord is damaged it should be replaced by the manufacturer or appointed service agent in order to avoid a hazard.
- Never remove the plug from the socket by pulling from the cord section. Remove the plug by holding.
- Do not plug the power supply with wet hands.
- Never touch the machine with wet hands or feet.
- Never open the detergent drawer while the device is running.
- Never force to open the door of the machine while the machine is running.
- Since the machine can reach high temperatures while running, do not touch the drain hose and water during draining.
- In case of any failure, first unplug the device and close the water tap. Do not attempt to repair. Please apply to the nearest authorized service station.
- Do not forget that the packing material of your machine may be hazardous for children.
- Do not let your children play with the washing machine.
- Keep your pet away from your machine.
- Your machine should only be used by adults within the information written in this manual.
- Your machine is designed for use in house environment. Warranty will be invalid if you use it for commercial purposes.
- The appliance should not be put on a carpet which can block the air ventilation on the bottom side.

RECOMMENDATIONS

- The detergent or softener in contact with air for a long time will dry and stick to your detergent drawer. To avoid this put your detergent and softener into the detergent drawer just before washing.
- It is recommended that you use pre-washing program for only very dirty clothes.
- Please do not exceed the maximum loading capacity.

- If you will not use your machine for a long time, unplug your machine, close the water supply and leave the door open in order to keep the inside of the machine dry and for prevention from unpleasant odour.
- As a result of the quality control procedures, a certain amount of water may remain in your machine. This is not harmful for your machine.

SECTION 2: INSTALLATION

You must pay attention to the following issues before using your washing machine.

REMOVAL OF TRANSPORTATION SCREWS

- Transportation screws, which are located at the back side of the machine, must be removed before running the machine.
- Loosen the screws by rotating counterclockwise by a suitable wrench. (DIAGRAM-1)
- Remove the screws by pulling them. (DIAGRAM-2)
- To the holes where the transport screws have been removed, insert the plastic transport screw taps found in the accessories bag. (DIAGRAM-3)
- The transportation screws, that have been removed from the machine should be kept in hand for any other transportation necessities.



DIAGRAM-1

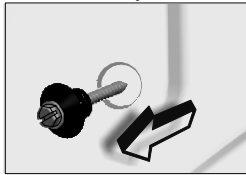

DIAGRAM-2

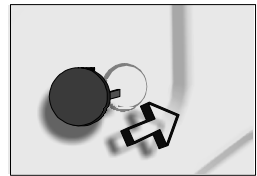
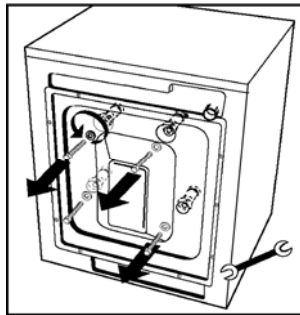
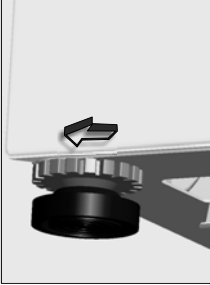

DIAGRAM-3



ADJUSTMENT OF FEET

- Do not install your machine on rugs or similar surfaces.
- For your machine to work silently and without any vibration, it should be settled on a flat, non-slippery and tough ground.
- You can adjust the balance of your machine from its feet.
- First, loosen the plastic adjustment nut.
- Adjust by rotating the feet upwards or downwards.
- After the balance has been reached, tighten the plastic adjustment nut again by rotating it upwards.
- Never put cartons, wooden blocks or similar materials under the machine to balance the irregularities on the level of the ground.



ELECTRICAL CONNECTION

- Your washing machine works with 220-240V and 50Hz.
- A special grounded plug has been attached to the network cable of your washing machine. This plug must definitely be inserted to a grounded socket with 10 ampere. The fuse flow value of the electricity line attached to this should also be 10 ampere. If you have no such sockets and fuses in your house, let it be made by a qualified electrician.
- **Our company will not be responsible for any damages that may occur as a result of usage without grounding.**
- **Insert the machine's plug to a grounded socket which you can easily reach.**

WATER SUPPLY CONNECTION

- Depending on the features your machine, may be with single water inlet (cold) or double water inlet (cold/hot). The white headed hose is for cold water inlet and red headed hose is for hot water inlet (valid for machines with hot&cold water inlet).
- To prevent leakage from the connection joints, 1 (valid for cold water inlet) or 2 (valid for machines with hot&cold water inlet) seals are included in the hose packing. Fit these seals at the end of water inlet hoses on the tap side.
- Connect the white headed hose to the water inlet valve with white filter and connect the red headed hose to the water inlet valve with red filter (latter is valid in machines with hot&cold water inlet). Tighten the plastic parts of the connections with your hand. Please call a qualified plumber for safer connections.

- Water pressure of 1-10 bars from your tap will enable your machine to work more efficiently.(1 bar pressure means water flow of more than 8 liters in 1 minute from a fully opened tap).
- After connections are completed, check for the non-leakage of the connection joints by turning on your tap completely.
- Be sure that water inlet hoses are not folded, broken or crushed.
- Mount the water inlet hoses to a 3"/4, geared water tap.

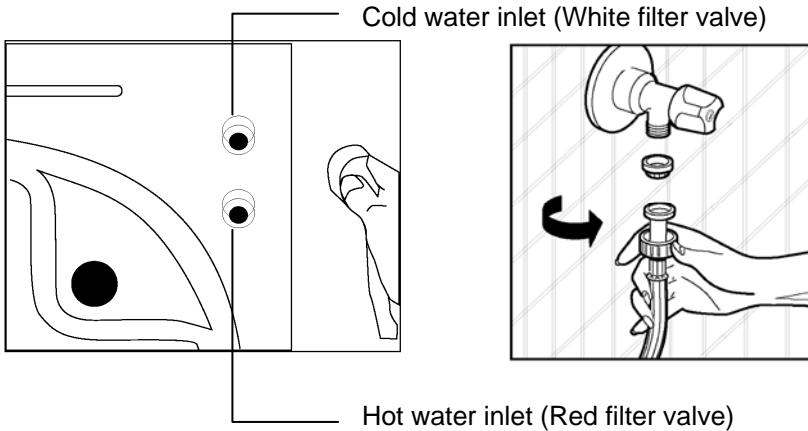

WATER DRAIN CONNECTION

- Be sure that water inlet hoses are not folded, twisted, crushed or elongated by stretching.
- Water drain hose should be mounted at a height of minimum 60 cm, maximum 100 cm from the ground.
- The end of the water drain hose may directly be fitted to the dirty water outlet hole or a special apparatus mounted on the outlet bracket of the wash-stand.
- Never attempt to extend the water drain hose by adding extra parts.

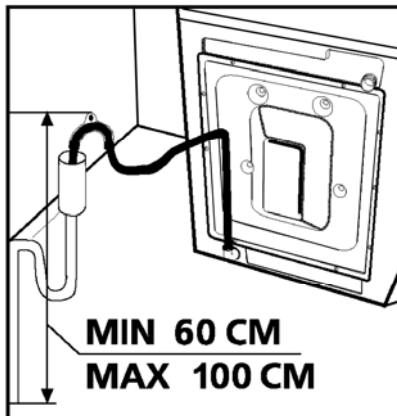

SECTION 3: TECHNICAL SPECIFICATIONS

	32 LT	40 LT	42 LT	47 LT	52 LT	57 LT
Maximum dry laundry capacity (kg)	3,5	5	5	6	7	7,5
Recommended loading (kg)	3	4,5	4,5	5,5	6,5	7
Height (cm)	85	85	85	85	85	85
Width (cm)	59,6	59,6	59,6	59,6	59,6	59,6
Depth (cm)	37	42	51	54	57	60
Maximum spin cycle (rpm)	800/ 1000/1200	800/ 1000/1200	600/800/ 1000/1200/ 1400/1600	600/800/ 1000/1200/ 1400/1600	600/800/ 1000/1200/ 1400/1600	600/800/ 1000/1200/ 1400/1600

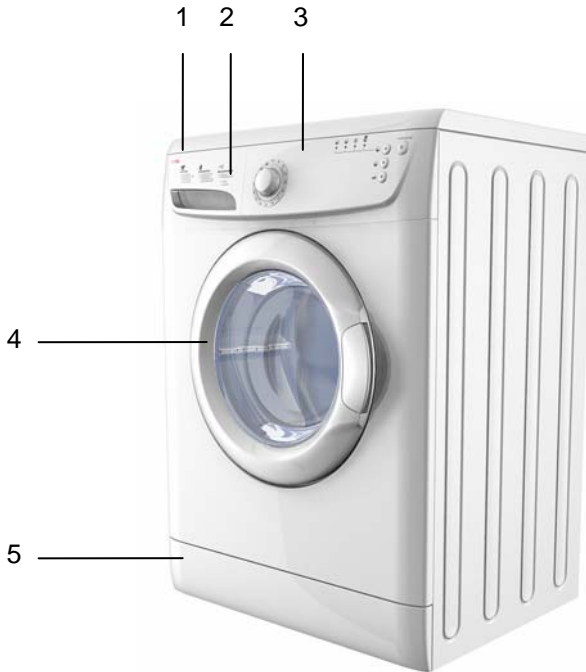

- 1-Upper tray
- 2-Detergent drawer
- 3-Control panel
- 4-Door

5-Kickplate

These technical specifications written above for single water inlet (cold) and double water inlet (cold/hot) in machines.

SECTION 4:CONTROL PANEL

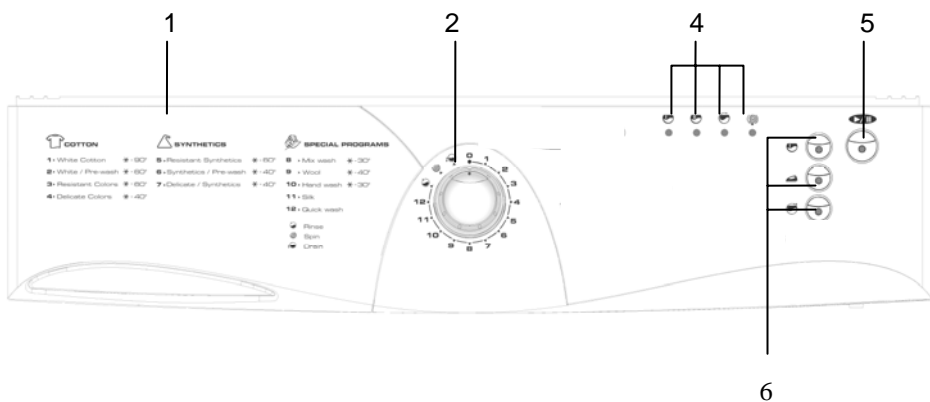

- 1- Detergent drawer
- 2- Program knob
- 4- Washing operation light

- 5- Start/pause and cancel button
- 6- Function buttons



START/PAUSE BUTTON

This button is used for starting a selected programme or putting a programme in progress on pause.

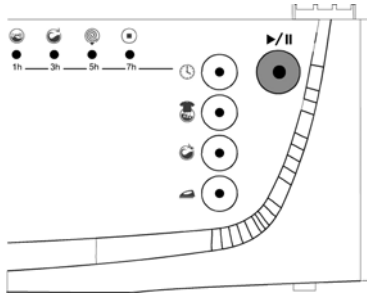

FUNCTION INDICATOR LAMPS

Pressing the start/hold button or any other function button switches on the lamps found above the buttons and the control panel, which indicate the wash stages of programmes. When any one of these lamps is on it means that certain programme is in use. The lamp is off when any function button or the start/hold button is pressed, or the selected function has finished its operation.

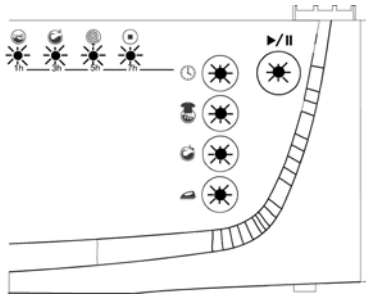

FUNCTION BUTTONS



Rinse hold

This function is recommended to be used when the clothes cannot be taken immediately after the end of the program. This will prevent occurrence of wrinkles. When this button is pressed, the last rinsing water is not drained. For the program to continue from the same point, repress the same button.

If you do not want your sensitive clothes to be spinned or you want them to be spinned sensitively, turn the program knob to O (off) position. Bring the program knob on one of the draining or spinning programs you desire and press the start/pause button. If the program you have selected is a drain program, your machine will draining the water inside. If you have selected a spinning program, your machine will perform a spinning operation and then end the program.



Extra rinse

You can have one more rinsing done in addition to the rinses which your machine has made in all washing programs by using this function.



Easy ironing

By using this function, you can ensure your clothes to come out less wrinkled after the washing.



Economy wash

This function serves for saving energy via decreasing the temperature value and increasing the wash time of the selected wash programme by a certain level.

Your machine has also an automatical load detection system. If you load your machine with half load or less than half load, your machine can detect this lower load and change the program flow. If it happens, your “rapid wash” option lamp will be on to show you that lower load is detected. If you don’t want your program flow to be changed, then you can press “rapid wash” option button again and cancel detection. This time machine will work with normal program flow and it will not be possible to activate “rapid wash” for this cycle again.



The prewash

With this function you can start an additional wash operation for heavily soiled laundry. When you use this function you must put detergent into the prewash compartment of the detergent drawer. If the additional function features of your machine contain this option and you will wash your laundry in a prewash programme, the lamp above the function button will automatically light up. Even if you press the function button to cancel this feature it will not be cancelled at a wash function with a prewash operation.



Plus water

By using this function, you can enable your machine to take in some more water than the amount in the normal washing operation. This will decrease the friction that occurs between your clothes. This function is recommended to be used for your sensitive clothes or for the ones you desire to be rinsed really well.



Timer

The timer function enables you to set your machine to start its wash operation with delay. Depending on the delay time you wish the programme to start at press the function button until the desired delay timer lamp (1h/3h/5h/7h) lights up on the control panel. The lamp above the function button will flash. Start the programme by pressing the start/hold button. If the function button is pressed once more, this option is cancelled and you go back to the selection mode. After pressing the start/pause button, the countdown of the time delay begins. When the programme starts, the start delay indicator light goes off and is replaced by the programme sequence indication.

WARNING!

If you have forgotten to use an additional function and the machine has started the wash operation press the button of the additional function you wish to select; if the indicator lamp above it keeps lighting the additional function you selected will become active. If the lamp stays lit for a certain while and then goes out the additional function you selected will not become active.

NOTE: Our products contain electronic cards and touchscreen buttons. Lightly pressing on the buttons will suffice to activate the functions.

PROGRAM KNOB

With the program knob, you can select the program with which you desire to wash your clothes. You can adjust the program selection process by turning the program knob in both directions. You must be careful that the adjustment sign of the program knob is exactly on the program you want to select. When you bring the programme knob to STOP (off) position, your machine will carry out the drain operation in order to finish (cancel) programme cycle. After drain is finished, machine will go into Standby Mode. You can now select another programme you wish to start.

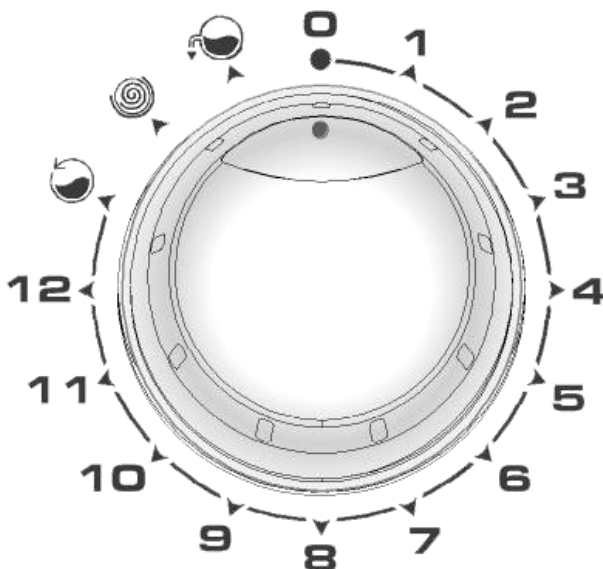

STOP

1-Cotton 90°

2-Cotton 60° (prewash)

3-Cotton 60°

4-Cotton 40°

5-Synthetic 60°

6-Curtain wash

7-Synthetic 40°

8-Synthetic 30°

9-Wool 40°

10-Wool 30°

11-Wool cold

12-Quick wash

 Rinsing

 Spinning

 Draining

SECTION 5: WASHING YOUR LAUNDRY

- Plug the machine.
- Open the tap water.

First wash cycle

There may be water left inside your machine after factory tests and trials. It is recommended that the first wash cycle should be made without any laundry so that carry out this water; pour half a measuring cup of normal allpurpose detergent into compartment 2 and select cotton program at 90°C.

BEFORE WASHING

Discrimination of your laundry

- Discriminate your clothes according to their types (cotton, synthetic, sensitive, woolen, etc.), washing temperatures and level of dirtiness.
- Never wash your white and coloured clothes together.
- Since your new coloured clothes may shed dye on the first wash, wash them separately.
- Be careful that no metal pieces are found on or in the pockets of your clothes, remove if there is any.
- Zip and button your clothes.
- Remove the plastic or metal hooks of the curtains and laces or place them inside a washing bag and tie.

- Pull the textiles like trousers, knitted fabric, t-shirt and sweat shirt inside out.
- Wash your small clothes like socks and handkerchiefs in a washing bag.



Wash up to 90 °C Wash up to 60 °C Wash up to 30 °C Not washable in washing machine

Placement of the clothes into the machine

- Open the door of your machine.
- Fill your clothes in your machine in a well-spread manner.
- Place each cloth separately.
- When you shut the door of your machine, be careful that no cloth is jammed between the cover and the gasket.
- Shut the door of your machine tightly otherwise your machine will not start the washing process.

Filling detergent in the machine

The quantity of the detergent that you will fill in your machine depends on the following criteria:

- Your detergent consumption will change according to the dirtiness level of your clothes. For your slightly dirty clothes, do not pre-wash and put a small amount of detergent in the compartment no.2 of the detergent drawer.
- For your excessively dirty clothes, select a program with pre-washing, fill ¼ portion of the detergent you will put in compartment 1 in the detergent drawer and the remaining portion in compartment 2.
- In your machine, use the detergents developed especially for automatic washing machines. The quantities that will be used for your clothes are written on the packing of the detergents.
- As the hardness of your water increases, the amount of the detergent to be consumed will also increase.
- As the amount of your clothes increases, the amount of the detergent to be consumed will also increase.
- Fill your softener in the softener compartment in your detergent drawer. Do not exceed the MAX level. Otherwise, the softener will diffuse in the washing water via the siphon.
- The softeners with high density should be diluted with some water before filling in the drawer. That is because the softener with high density obstructs the siphon and prevents the flow of the softener.

- You can use fluid detergents in all programs without pre-washing. For this, mount the fluid detergent level plate in the second compartment of the detergent drawer and arrange the amount of fluid detergent according to the levels on this plate.

RUNNING THE MACHINE

Program selection and features

Select programmes and additional functions appropriate for your laundry with the help of the tables shown on pages 19.

Just for the first run please choose a program and press Start/pause button for 4 seconds, before putting your load in. This is necessary for unloading the water that is left after the production and tests.

Start/Pause button

Pressing this button you can start the programme you selected or put the programme in progress on pause.

When the programme you selected starts its operation the lamp above the start/pause button will start lighting.

When you wish to put the selected programme on pause press the start/pause button once. The lamp above it will start to flash. In order to restart the programme from the point it was put on pause at you will have to press the start/pause button once again.

Starting the program

- Adjust the programme button to a programme you wish to select.

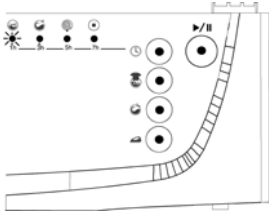

- If the programme you selected is a wash programme the wash operation lamp will flash.

- If the programme you selected is a rinse/spin or drain programme the lamps indicating the related selection will flash.

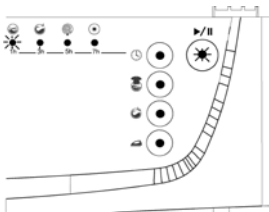
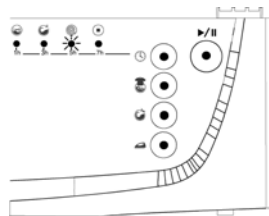
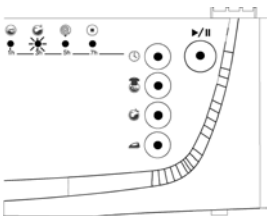

- Start the selected programme by pressing the start/pause button.
- When you start the programme by pressing the start/pause button the lamps will light up indicating that the start/pause button is active and the wash operation is in progress.

Selecting an additional function button

- Adjust the programme button to a programme you wish to select.
- If the programme you selected is a wash programme the wash operation lamp will light up.

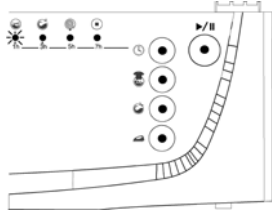

- If the programme you selected is a rinse/spin or drain programme the lamps indicating the related selection will light up.

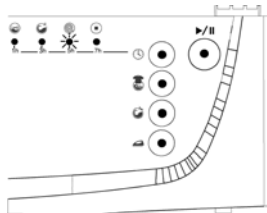
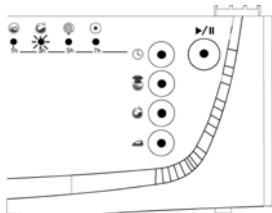

In order to select an additional function:

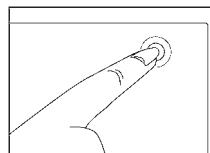

- Press once the additional function button you wish to select.

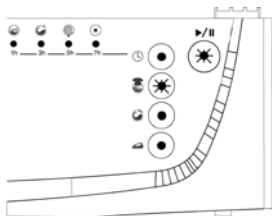

- If the lamp above the function button keeps lighting it means you have selected the function you wished to select.
- If the lamp above the function button is flashing it means you cannot use that additional function for the wash programme you selected.

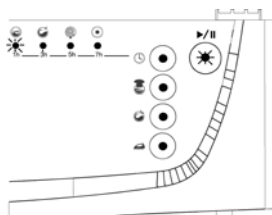

- Start the selected programme by pressing the start/pause button.
- When you start the programme by pressing the start/pause button the lamps will light up indicating that the start/pause button is active and the wash operation is in progress.

Cancelling a programme

If you wish a certain programme in progress to finish early:

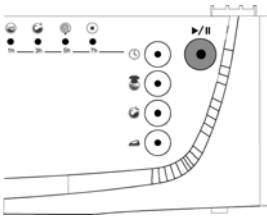

- Press the start/pause button for 4 seconds.

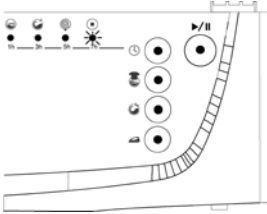

- Your machine will carry out the drain operation necessary for the programme to finish, and then end the programme.
- The programme end lamp will be on.
- You can now select another programme you wish to select.

Programme end

- Your machine will stop automatically when the programme you selected has finished.

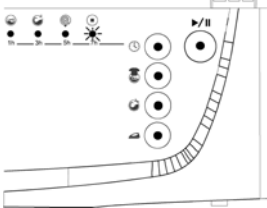

- The programme end lamp will light up.

- Bring the programme button to the STOP (off) position.
- The door lock of your machine will automatically release about two minutes after the programme has finished. You can open the door and take out the laundry by pulling the door handle towards yourself.
- After you have taken out the laundry leave the door open so that the machine interior can dry.
- Unplug the machine.
- Turn off the water tap.

WARNING!

In the event power is cut off at any stage of the wash programmes and then resupplied after a certain while your machine will continue the programme from the point it was interrupted at. Such a situation will not cause any harm to your machine.



In the event power is cut off during the wash operation the door lock mechanism will release its hold after two minutes. If there is water in the machine do not open the door or the water will pour out. If you wish to take out your laundry you can do so by draining the water inside the machine following the instructions explained in the section “cleaning the pump filter” on pages 20 and 21.

Child lock

Your machine is equipped with a child lock in order to prevent a programme's operation from being affected by a push on a button during a wash operation. The child lock will become active after the first and second function buttons on the control panel are pressed at the same time and for longer than three seconds.

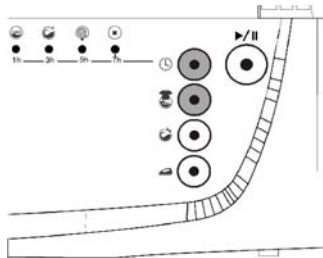
You can notice the activation of the child lock by checking out the programme wash,rinse and spin lamps which will flash for two seconds. In order to deactivate it you will have to press the same buttons for longer than three seconds. If you press any button when child lock is active, button will not be activated and you can see wash,rinse and spin lamps flashing for two seconds in order to show child lock is active. You can notice the deactivation by checking out the programme end lamp which will flash for two seconds. When the programme has finished, child lock will automatically be deactivated.



PROGRAM	Detergent Compart.	Max. Dry Load Capacity (kg)						Type of Laundry	Explanations
		32 LT	40 LT	42 LT	47 LT	52 LT	57 LT		
1-COTTON 90°	2	3,5	5	5	6	7	7,5	Dirty, boil, cotton and linen textile	Underwears, sheet, table cloth, t-shirt, shirt, towel
2- COTTON 60° (PREWASH)	1+2	3,5	5	5	6	7	7,5	Very dirty, cotton, coloured and linen textile	
3- COTTON 60°	2	3,5	5	5	6	7	7,5	Dirty, cotton, coloured and linen textile	
4- COTTON 40°	2	3,5	5	5	6	7	7,5	Slightly dirty, paint to get out, cotton, coloured and linen textile	
5-SYNTHETIC 60°	2	2	3	3	3	3,5	4	Dirty, synthetic or synthetic mixture textile	Nylon socks, blouse
6-CURTAIN WASH	1+2	2	3	3	3	3,5	4	Very dirty, synthetic or synthetic mixture textile	
7- SYNTHETIC 40°	2	2	3	3	3	3,5	4	Dirty, synthetic or synthetic mixture textile	
8- SYNTHETIC 30°	2	2	3	3	3	3,5	4	Slightly dirty, cotton, coloured and linen textile	T-shirt, nylon socks, shirt,
9-WOOL 40°	2	1	2	2	2	2	2,5	Dirty, hand and machine to wash wool laundry	All wool laundry
10-WOOL 30°	2	1	2	2	2	2	2,5	Very slightly dirty, cold water, hand and machine to wash wool laundry	
11-WOOL COLD	2	1	2	2	2	2	2,5	Very slightly dirty, cold water, hand and machine to wash wool laundry	Silk mixture laundry
12-QUICK WASH	2	2	2,5	2,5	3	3	3,5	Slightly dirty, cotton, coloured and linen textile	Underwears, sheet, table cloth, t-shirt, shirt, towel
RINSE		When you need an additional rinsing to be done to your clothes after the washing process, you can use this program for all kinds of clothes.							
SPIN		You can use this program, when you need an additional spinning to be done to your clothes after the washing process. Please do not use this program for your delicate or woolen laundry.							
DRAIN		This program is used to drain the dirty water inside after the washing process of your machine. If you want the water inside your machine to be drained before the program ends, you can use this program.							

SECTION 6: MAINTENANCE AND CLEANING

- Unplug your machine.
- Close the water tap.

WATER INLET FILTERS

On the tap part of your machine's water inlet hose and at the ends of water inlet valves, there are filters to prevent entrance of the dirt and foreign materials in the water to the machine. If the machine is unable to receive sufficient water although your water tap is opened, these filters should be cleaned.

- Remove the water inlet hose.
- Remove the filters found on the water inlet valves by using a pincer and wash thoroughly with a brush.
- Clean the filters of the water inlet hoses located on the tap side by removing manually together with the seal.
- After you clean the filters, you can fit them the same way as you have removed.

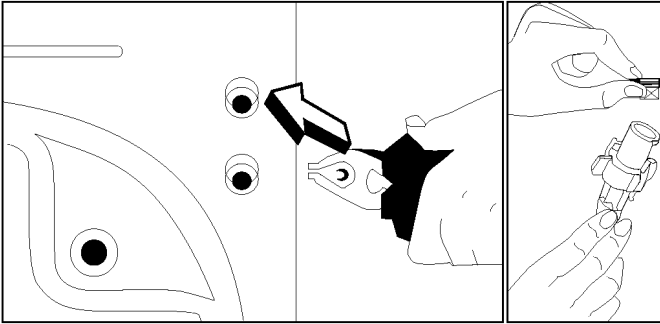

PUMP FILTER

The pump filter system elongates the life of your pump, which is used to drain the dirty water. It prevents lint to enter the pump. Cleaning of your pump filter in every 2-3 months is recommended. To clean your pump filter:

- Remove the kickplate by pushing with your hand upwards from the lower claws and pulling towards yourself.
- Before opening the filter cover, place a cup in front of the filter cover to prevent flow of the remaining water in the machine.
- Loosen the filter cover by rotating it counter clockwise and drain the water.
- Remove the foreign materials from the filter.
- Check for the rotation of the pump manually.
- After you have cleaned the pump, fit the filter cover by rotating clockwise.
- Fit in the kickplate by holding from the claws and push it.
- Do not forget that if you do not fit in the filter cover properly, it will leak water.

⚠ WARNING!

Danger of being scalded!

Since the water inside the pump maybe hot, wait for it to cool.

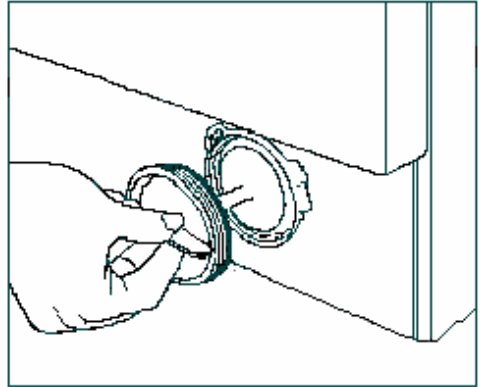
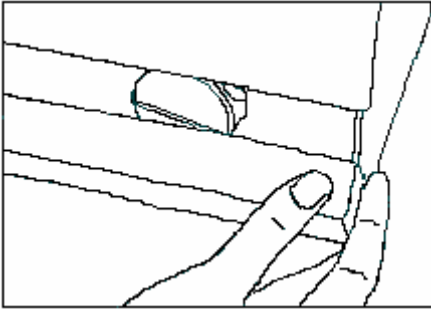

DETERGENT DRAWER

Detergents may cause residue buildup in the detergent drawer and in its slot over time. Take out the detergent drawer periodically to clean up the accumulated residue. In order to take out the drawer:

- Pull the drawer to its end (DIAGRAM-1).
- Keep pulling by pressing on the siphon lid inside the drawer pulled to its end, and remove the drawer from its place (DIAGRAM-2).
- Wash it up with water with the help of an old toothbrush.
- Collect the residues inside the drawer slot without letting them drop into the machine.
- After thoroughly drying the drawer put it back in its place reversing the removal procedure.

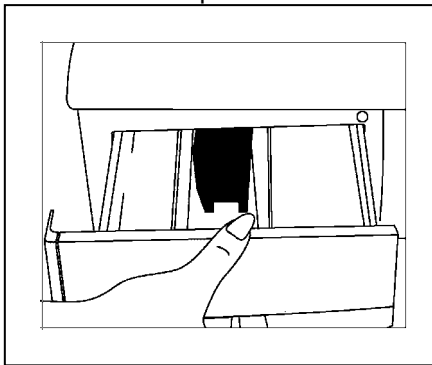

DIAGRAM-1

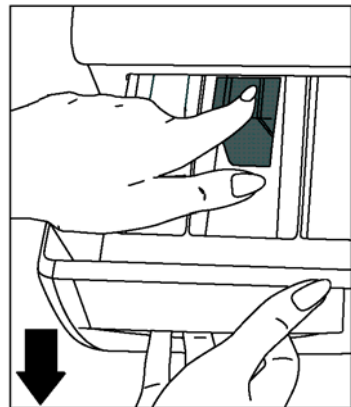
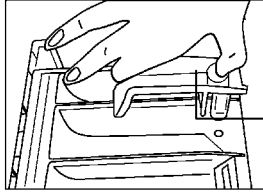

DIAGRAM-2

SIPHON PLUG

Pull out the detergent drawer. Remove the siphon plug and clean the residues of the softener thoroughly. Fit the cleaned siphon plug in its location. Check if it placed properly.



Siphon plug

THE CABINET

Clean the exterior surface of the cabinet of your machine with lukewarm water and a cleaning substance that will not irritate the cabinet. After rinsing with clean water, wipe it with a soft and dry cloth.

WARNING!

If the machine is installed in a location where the ambient temperature can fall below 0 °C, do the following when it will not be in use:

- Plug in the machine.
- Close the water tap and pull out the water inlet hose or hoses from the tap.
- Place the ends of the water drain and water inlet hoses in a cup on the ground.
- Adjust the program knob to “Draining” program.
- The program ready light will be on.
- Run the program by pressing the start/pause button.
- Unplug your machine when the program is over (program end light is on).

When you complete these proces, the remaining water inside the machine will be drained and thus formation of ice in the machine will be prevented. When you operate your machine again, be sure that the ambient temperature is above 0 °C.

THE DRUM

Do not leave metal parts like needles, staples or coins inside your machine. These pieces cause formation of rust stains in the drum. To eliminate these stains of rust, use a cleaning substance without chlorium and follow the warnings of the cleaning substance producer. For cleaning of the rust stains, never use dish-washing wires or similar rough objects.

REMOVE OF LIME FROM YOUR MACHINE

If you arrange the amount of the detergent you use in your machine properly, there will be no need for lime removal. However, if you desire to apply the removal procedure, use the lime protectors in the market and pay attention to their warnings.

WARNING!

The lime eliminating substances contain acids and this may cause colour modifications in your clothes along with an adverse effect on your machine.

SECTION 7:PRACTICAL INFORMATION



Alcoholic beverages: The stain point, should first be washed with cold water, than should be wiped with glycerine and water and be rinsed with water mixed with vinegar.



Shoe Polish: The stain should be slightly scratched without ruining the cloth, rubbed with detergent and rinsed. In case it is not eliminated, it should be rubbed with 1 unit of pure alcohol (96 degrees) mixed in 2 units of water and then washed with lukewarm water.



Tea and coffee: Stretch the stained area of your cloth on the top of a container and pour water as hot as the type of your cloth can endure on it. If the type of your cloth is suitable, wash it with lye.



Chocolate and cocoa: By leaving your clothes in cold water and rubbing with soap or detergent, wash it in the highest temperature that the type of your cloth can endure. If there is still a stain of oil left, wipe with oxygenated water (in proportion of 3%).



Tomato paste:After scraping the dried pieces without ruining the cloth, leave in cold water for about 30 minutes and wash by rubbing with detergent.



Meat broth-egg: Eliminate the dried stain residues and wipe with a sponge or soft cloth wetted in cold water. Rub with detergent and wash with diluted lye.



Grease and oil stains: First wipe the residues. Rub the stain with detergent and then wash with lukewarm soapy water.



Mustard: First apply glycerine to the stained area. Rub with detergent and then wash. If the stain still does not disappear, wipe with alcohol (On synthetic and coloured cloth, a mixture of 1 unit alcohol, 2 units water should be used)



Blood stain: Lay your clothes in cold water for 30 minutes. If the stain still does not disappear, lay in mixture of water and ammonia (3 table-spoons of ammonia in 4 liters of water)for 30 minutes.



Cream, ice-cream and milk: Lay your clothes in cold water and rub the stained area with detergent. If the stain has still not disappeared, apply lye on the fabric of your clothes in proper proportion.(Do not use lye on coloured clothes.)



Mould: Mould stains should be cleaned as soon as possible. The stain should be washed with detergent, and if it does not disappear, it should be wiped with oxygenated water (in proportion of 3%).



Ink: Hold the stained area under cold water and wait until the inky water completely runs off. Then rub with water diluted with lemon juice and detergent, wash after waiting for 5 minutes.



Fruit: Stretch the stained area of your clothes on the top of a container and pour cold water on it. Do not pour hot water on the stain. Wipe with cold water and apply glycerine. Wait for 1-2 hours and rinse after wiping with a few drops of white vinegar.



Grass stain: Rub the stained part with detergent. If the type of fabric is suitable for use of lye, wash it with lye. Rub your woolen clothes with alcohol. (For coloured ones, a mixture of 1 unit pure alcohol and 2 units of water).



Oil Paint: The stain should be eliminated before it dries by applying thinner on it. Then it should be rubbed with detergent and washed.



Burnt stain: If your cloth is suitable for use of lye, you can add lye into your washing water. For woolen fabric, a cloth damped in oxygenated water should be covered on the stain and it should be ironed with a dry cloth on it. It should be washed after rinsing well.

SECTION 8: AVOIDING MINOR FAULTS

All repairing which must be done on the machine should be done by authorized service. When a repairing is required for your machine or you are unable to eliminate the failure with the help of the information given below:

- Unplug the machine.
- Close the water tap.
- Apply to the nearest authorized service station.

FAILURE	PROBABLE CAUSE	METHODS OF ELIMINATION
Your machine does not operate.	It is unplugged.	Insert the plug into the socket.
	Your fuse is defected.	Change your fuse.
	The electric power is off.	Check the electric power.
	Start/pause button has not been pressed.	Press the start/pause button.
	The program knob is in O(off) status.	Bring the program knob on the desired status.
	The door is not shut properly.	Shut the door properly. You should hear the click.
Your machine does not receive water.	Water tap is closed.	Open water tap.
	The water inlet hose may be bent.	Check the water inlet hose.
	The water inlet hose is obstructed.	Clean the filters of water inlet hose. (*)
	The valve inlet filter is obstructed.	Clean the valve inlet filters. (*)
	The door is not shut properly.	Shut the door properly. You should hear the click.
Your machine is not draining water.	The drain hose is obstructed or bent.	Check the drain hose.
	The pump filter is obstructed.	Clean the pump filter. (*)
	The clothes are not placed inside the machine in a well-balanced manner.	Spread the clothes inside the machine in an orderly and well-balanced manner.
Your machine is vibrating.	The feet of your machine are not adjusted.	Adjust the feet. (**)
	Transportation screws are not removed.	Remove transportation screws. (**)

(*)See the section concerning the maintenance and cleaning of your machine.

(**)See the section concerning installations your machine.

FAILURE	PROBABLE CAUSE	METHODS OF ELIMINATION
Your machine is vibrating.	There is a small amount of clothes in the device.	It does not prevent operation of the machine.
	Excessive amount of clothes are filled in the machine or the clothes are not placed in a well-balanced manner.	Do not exceed the recommended quantity of clothes and spread your clothes in the machine in a well-balanced manner.
	Your machine touches a rigid object.	Prevent your machine's leaning on a tough place .
Excessive foam in the detergent drawer.	Too much detergent has been used.	Press the start/pause button. In order to stop the foam, dilute one table-spoon of softener in half liter of water and pour it in the detergent drawer. Press the start/pause button after 5-10 minutes. Arrange the amount of the detergent properly in the next washing process.
	Wrong detergent has been used.	Use only the detergents produced for full automatic machines.
The washing result is bad.	Your laundry too dirty for the program you have selected.	Select a suitable program. (see Table-1)
	The amount of detergent used is not sufficient.	Use more detergent according to the detergent.

FAILURE	PROBABLE CAUSE	METHODS OF ELIMINATION
The washing result is not good.	Clothes exceeding the maximum capacity has been filled in your machine.	Put the clothes in your machine in a manner not to exceed its maximum capacity.
	Your water may be hard.	Use the amount of detergent according to the declaration of the detergent producer.
	Distribution of the clothes in your machine is not well-balanced.	Spread the clothes inside the machine in an orderly and well-balanced manner .
The water is drained from the machine as soon as it is filled.	The end of the water drain hose is in a position too low according to the machine.	Place the water drain hose in an appropriate height.(**)
No water is seen in the drum during washing.	No failure. The water is at the lower part of the drum.	-
There are residues of detergent on the clothes.	The pieces of some detergents which do not dissolve in water may stick to your clothes as white stains.	By calibrating your machine for "Rinsing" program,make an additional rinsing or eliminate the stains After drying with the help of a brush.
There are gray stains on the clothes.	These stains may be caused by oil,cream or ointment .	In the next washing operation, use the maximum detergent amount declared by the detergent producer.

(**) See the section concerning instalations your machine.

FAILURE	PROBABLE CAUSE	METHODS OF ELIMINATION
<p>The spinning process is not done or starts with delay .</p>	<p>No failure. The unbalanced load control may works in that way.</p>	<p>The unbalanced load control system will try to distribute your clothes in a homogenous manner. After your clothes are distributed, passage to spinning process will be realized. In the next washing process, place your clothes into the machine in a well-balanced manner.</p>

SECTION 9: AUTOMATIC FAILURE DETECTION SYSTEM

Your machine is equipped with systems which will both take the necessary precautions and warn you in case of any failure by controlling it self constantly during the washing processes.

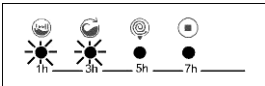
FAILURE CODE	FAILURE INDICATOR	PROBABLE FAILURE	THE PROCESS TO BE DONE
<p>E01</p> 	<p>The 1 and 2 number light blinks.</p>	<p>The door is not shut properly.</p>	<p>Shut the door properly so that you hear the click. If the problem persists, turn off the machine unplug and apply to the nearest authorized service immediately.</p>

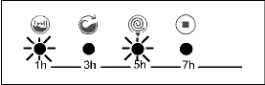
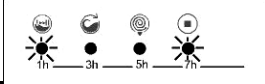
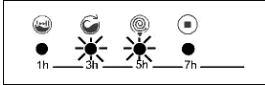

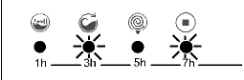
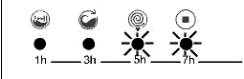
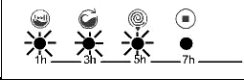
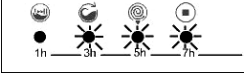

FAILURE CODE	FAILURE INDICATOR	PROBABLE FAILURE	THE PROCESS TO BE DONE
<p style="text-align: center;">E02</p> 	<p>The 1 and 3 number light blinks.</p>	<p>The water level in your machine is below heater. The pressure of your water supply may be low or locking.</p>	<p>Turn on the tap to the end. Water may be cut, check it. If the problem is still continuing, your machine will automatically stop after a while. Unplug your machine, turn off the tap and apply to the nearest authorized service.</p>
<p style="text-align: center;">E03</p> 	<p>The 1 and 4 number light blinks .</p>	<p>The pump has failed or the pump filter is obstructed or drain pump is in open circuit.</p>	<p>Clean the pump filter. If the problem persists, apply to the nearest authorized service. (*)</p>
<p style="text-align: center;">E04</p> 	<p>The 2 and 3 number light blinks.</p>	<p>There is an excessive amount of water in your machine.</p>	<p>Your machine will automatically drain the water. After your machine has completed the draining process, shut down your machine and unplug. Close the tap and apply to the nearest authorized service.</p>

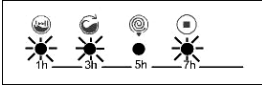
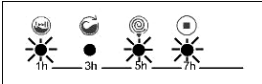



(*) See the section regarding the maintenance and cleaning of your machine.





FAILURE CODE	FAILURE INDICATOR	PROBABLE FAILURE	THE PROCESS TO BE DONE
<p style="text-align: center;">E05</p> 	<p>The 2 and 4 number light blink.</p>	<p>The heater of your machine or the heat sensor has failed.</p>	<p>Shut down your machine and unplug. Turn off your tap and apply to the nearest authorized service.</p>
<p style="text-align: center;">E06</p> 	<p>The 3 and 4 number light blink.</p>	<p>The motor has failed.</p>	<p>Shut down your machine and unplug. Turn off the tap and apply to the nearest authorized service.</p>
<p style="text-align: center;">E07</p> 	<p>The 1,2 and 3 number light blink.</p>	<p>Electronic card has failed.</p>	<p>Shut down your machine and unplug. Turn off the tap and apply to the nearest authorized service.</p>
<p style="text-align: center;">E08</p> 	<p>The 2,3 and 4 number light blink.</p>	<p>The motor has failed.</p>	<p>Shut down your machine and unplug. Turn off the tap and apply to the nearest authorized service.</p>



FAILURE CODE	FAILURE INDICATOR	PROBABLE FAILURE	THE PROCESS TO BE DONE
<p style="text-align: center;">E09</p> 	<p>The 1,2 and 4 number light blink.</p>	<p>The network voltage is too high or too low.</p>	<p>If the network voltage is lower than 150V or higher than 260V, your machine will automatically stop. When the network voltage is recovered, your machine will continue its operation.</p>
<p style="text-align: center;">E10</p> 	<p>The 1,3 and 4 number light blink.</p>	<p>Communication error.</p>	<p>Shut down your machine and unplug. Turn off the tap and apply to the nearest authorized service.</p>

SECTION 10: INTERNATIONAL WASHING SIGNS

			
Washing temperature.	Do not wash (hand wash)	Lukewarm iron.	Medium hot iron.

			
Hot iron.	Do not iron.	Do not tumble dry.	Hang to dry.

			
Drip dry.	Dry flat.	Do not bleach.	Handy to bleach.

		
<p>All of these are dry cleaning symbols. The letters are to instruct the cleaner what type of solvent to be used. Garments bearing these symbols should not be washed in your machine unless the label says otherwise.</p>		

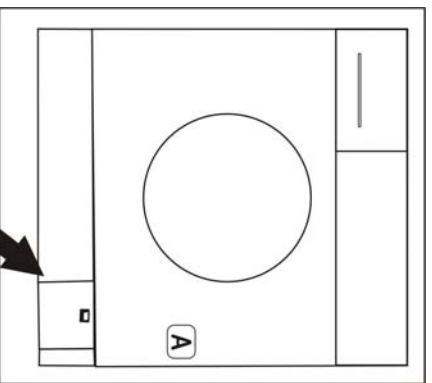

1-A

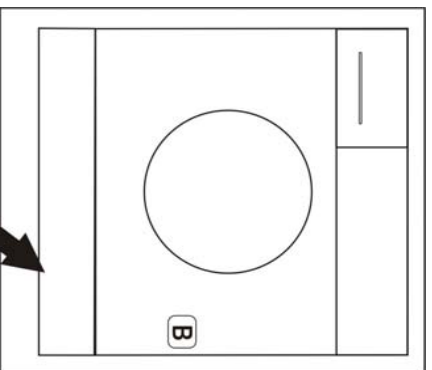

1-B

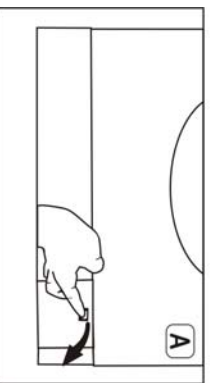

2-A

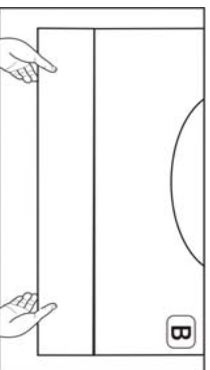

2-B

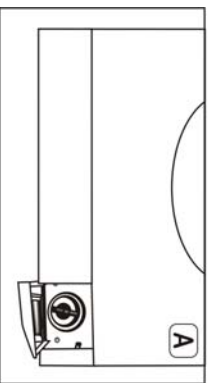

3-A

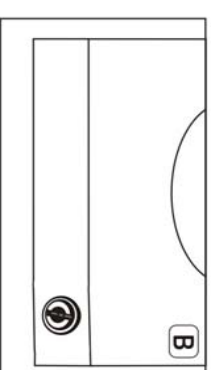

3-B

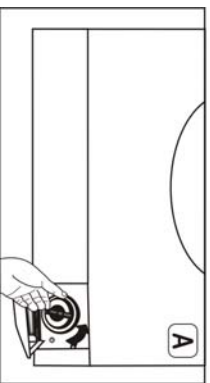

4-A

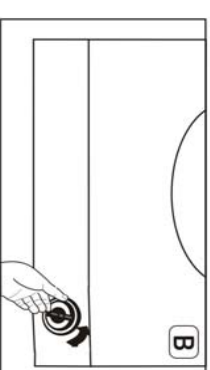

4-B

PUMP FILTER

The pump filter system elongates the life of your pump, which is used to drain the dirty water. It prevents lint to enter the pump. Cleaning of your pump filter in every 2-3 months is recommended. To clean your pump filter:

- * Open the kickplate's cover, by pulling the handle.
- * Before opening the filter cover, place a cup in front of the filter cover to prevent flow of the remaining water in the machine.
- * Loosen the filter cover by rotating it counter clockwise and drain the water.
- * Remove the foreign materials from the filter.
- * Check for the rotation of the pump manually.
- * After you have cleaned the pump, fit the filter cover by rotating clockwise.
- * Put the kickplate cover into the place.
- * Do not forget that if you do not fit in the filter cover properly, it will leak water.

A

PUMP FILTER

The pump filter system elongates the life of your pump, which is used to drain the dirty water. It prevents lint to enter the pump. Cleaning of your pump filter in every 2-3 months is recommended. To clean your pump filter:

- * Remove the kickplate by pushing with your hand upwards from the lower claws and pulling towards yourself.
- * Before opening the filter cover, place a cup in front of the filter cover to prevent flow of the remaining water in the machine.
- * Loosen the filter cover by rotating it counter clockwise and drain the water.
- * Remove the foreign materials from the filter.
- * Check for the rotation of the pump manually.
- * After you have cleaned the pump, fit the filter cover by rotating clockwise.
- * Fit in the kickplate by holding from the claws and push it.
- * Do not forget that if you do not fit in the filter cover properly, it will leak water.

B

FILTRE DE POMPE DE VIDANGE

Le système de pompe filtre prolonge la durée de vie de votre pompe, qui est utilisée pour évacuer l'eau sale. Il empêche la poussière de pénétrer dans la pompe. Il est recommandé de nettoyer votre pompe tous les 2 à 3 mois. Pour nettoyer le filtre de pompe :

- * Ouvrez le couvercle de la plaque de protection en tirant sur la poignée.
- * Avant d'ouvrir le couvercle du filtre, mettez une tasse devant le couvercle du filtre pour empêcher l'écoulement de l'eau restante dans la machine.
- * Desserrez le couvercle du filtre en le faisant pivoter dans le sens antihoraire et videz l'eau.
- * Enlevez les corps étrangers au filtre.
- * Procédez à une vérification manuelle de la rotation de la pompe.
- * Après nettoyage de la pompe, fixez à nouveau le couvercle du filtre en le faisant pivoter dans le sens horaire.
- * Remettez le couvercle de la plaque de protection en place.
- * N'oubliez pas que si vous ne fixez pas bien le couvercle du filtre, il y aura fuite d'eau.

A

FILTRE DE POMPE DE VIDANGE

Le filtre de pompe prolonge la durée de vie de votre pompe de vidange. Il empêche les peluches de pénétrer dans la pompe. Il est recommandé de nettoyer le filtre de pompe tous les 2 à 3 mois. Pour nettoyer le filtre de pompe :

- * Retirez la plinthe en la poussant manuellement vers le haut à l'aide des griffes, puis en la tirant vers vous (Fig. 12).
- * Avant de dévisser le filtre, placez un récipient sous le filtre pour laisser s'écouler l'eau résiduelle de la machine.
- * Dévissez le filtre en tournant dans le sens inverse des aiguilles d'une montre et vidangez (Fig.13).
- * Éliminez les impuretés sur le filtre.
- * Vérifiez manuellement la rotation de la pompe.
- * Après avoir nettoyé la pompe, revissez le filtre en tournant dans le sens des aiguilles d'une montre.
- * Il est important de bien revisser le filtre pour éviter tout risque de fuite.
- * Remettez la plinthe en place en la tenant par les griffes et poussez.

B

FILTRO DELLA POMPA

Il filtro della pompa consente di prolungare la durata di vita della pompa di scarico dell'acqua sporca. In questo modo si impedisce l'ingresso nella pompa di eventuali sfilacciate dei tessuti. La pulizia del filtro della pompa andrebbe effettuata ogni 2-3 mesi. Per pulire il filtro della pompa:

- * Aprire il coperchio dello zoccolo protettivo, tirando la maniglia.
- * Prima di aprire il coperchio del filtro, posizionare un contenitore davanti al filtro, per impedire la fuoriuscita dell'acqua rimasta nella macchina.
- * Allentare il coperchio del filtro ruotandolo in senso antiorario e far scaricare l'acqua.
- * Togliere eventuali corpi estranei dal filtro.
- * Controllare manualmente la rotazione della pompa.
- * Pulire la pompa, riposizionare il coperchio e ruotare in senso orario.
- * Rimettere il coperchio dello zoccolo protettivo in posizione.
- * E' opportuno ricordare che se non si posiziona il coperchio del filtro correttamente, vi saranno perdite di acqua.

A

FILTRO DELLA POMPA

Il filtro della pompa consente di prolungare la durata di vita della pompa di scarico dell'acqua sporca. In questo modo si impedisce l'ingresso nella pompa di eventuali sfilacciate dei tessuti. La pulizia del filtro della pompa andrebbe effettuata ogni 2-3 mesi. Per pulire il filtro della pompa:

- * Togliere lo zoccolo protettivo sollevandolo. Per farlo, far leva sulle griffe inferiori tirando contemporaneamente verso se stessi.
- * Prima di aprire il coperchio del filtro, posizionare un contenitore davanti al filtro, per impedire la fuoriuscita dell'acqua rimasta nella macchina.
- * Allentare il coperchio del filtro ruotandolo in senso antiorario e far scaricare l'acqua.
- * Togliere eventuali corpi estranei dal filtro.
- * Controllare manualmente la rotazione della pompa.
- * Pulire la pompa, riposizionare il coperchio e ruotare in senso orario.
- * Riposizionare lo zoccolo protettivo agendo sulle griffe e spingendolo in posizione.
- * E' opportuno ricordare che se non si posiziona il coperchio del filtro correttamente, vi saranno perdite di acqua.

B