

WF7704N6(W/V/S/C/R) WF7608N6(W/V/S/C/R)
WF7702N6(W/V/S/C/R) WF7522N6(W/V/S/C/R)
WF7700N6(W/V/S/C/R) WF7520N6(W/V/S/C/R)
WF7700N6(W/V/S/C/R)1 WF7528N6(W/V/S/C/R)
WF7708N6(W/V/S/C/R) WF7452N6(W/V/S/C/R)
WF7708N6(W/V/S/C/R)1 WF7450N6(W/V/S/C/R)
WF7604N6(W/V/S/C/R) WF7458N6(W/V/S/C/R)
WF7602N6(W/V/S/C/R) WF7350N6(W/V/S/C/R)
WF7600N6(W/V/S/C/R) WF7358N6(W/V/S/C/R)

Washing Machine user manual

imagine the possibilities

Thank you for purchasing a Samsung product.
To receive a more complete service,
please register your product at
www.samsung.com/global/register



features

- **Ceramic Heater for Durability & Energy Saving**

Our truly innovative Ceramic Heater is twice as durable as regular heaters. That saves you money on repairs. Plus, it eliminates the scale of hard water and save energy.

- **Child Lock**

The Child Lock function keeps curious little hands out of the washer. This safety feature ensures, that children do not toy with the operation of the washer. It also alerts you when it is activated.

- **Handwash for wool**

Clothes susceptible to damage, such as those made of linen or silk, can be washed just as if they were being washed by hand.

- **Delay Start**

This function enables uses to delay the washing machine's starting time for up to 24 hours.

- **Heavy Soil**

This Program is for stained of heavily soiled cottons, bed linen, table linen, underwear, towels, shirts, jeans, etc

- **My Favourite selection button**

You can program your wash cycle to best suit your needs. The memory function allows you to select rinse cycles, water temperatures, and spin cycles for each and every load. You can save your preferences, retrieve them another time...press and go! It's tailor-made washing only by Samsung!

safety information



Throughout this manual, you'll see Warning and Caution notes.

These warnings, cautions, and the important safety instructions that follow do not cover all possible conditions and situations that may occur.

It's your responsibility to use common sense, caution, and care when installing, maintaining, and operation your washer. Samsung is not liable for damages resulting from improper use.

IMPORTANT SAFETY SYMBOLS AND PRECAUTIONS

What the icons and signs in this user manual means:

 WARNING	Hazards or unsafe practices that may result in severe personal injury or death .
 CAUTION	Hazards or unsafe practices that may result in minor personal injury or property damage .
 CAUTION	To reduce the risk of fire, explosion, electric shock, or personal injury when using your washer, follow these basic safety precautions:

BEFORE USING THE APPLIANCE



The appliance is designed for home use only.

Make sure that water and electrical connections are made by qualified technicians, observing the manufacturer's instructions (see "Installing the Washing Machine") and local safety regulations.

All packaging and shipping bolts must be removed before the appliance is used. Serious damage may occur if they are not removed. See "Removing the shipping bolts".

Before washing clothes for the first time, you must run a complete cycle without clothes. See "Washing for the first time".

If this appliance is supplied from a cord extension set or electrical portable outlet device, the cord extension set or electrical portable outlet device must be positioned so that it is not subject to splashing or ingress of moisture.

safety information

SAFETY INSTRUCTIONS



Before cleaning or carrying out maintenance, unplug the appliance from the electrical outlet or set the dial to Off.

Make sure that the pockets of all clothing to be washed are empty. Hard, sharp objects, such as coins, safety pins, nails, screws, or stones can cause extensive damage to the appliance.

Always unplug the appliance and turn off the water after use.

Before you open the door of the appliance, check that the water has drained. Do not open the door if you can still see water.

Pets and small children may climb into the appliance. Check the appliance before each use.

The glass door becomes very hot during the washing cycle. Keep children away from the appliance while it is in use.

Do not attempt to repair the appliance yourself. Repairs made by inexperienced or unqualified persons may cause injury and/or make more serious repairs to the appliance necessary.

If the plug (power supply cord) is damaged, it must be replaced by the manufacturer or its service agent or a similar qualified person in order to avoid a hazard.

This appliance should only be serviced by an authorized service center, and only genuine spare parts should be used.

This appliance is not intended for use by persons (including children) with reduced physical, sensory or mental capabilities, or lack of experience and knowledge, unless they have been given supervision or instruction concerning use of the appliance by a person responsible for their safety.

This appliance has to be connected to the plug endurable to proper power consumption.

This appliance has to be positioned so that the plug is accessible after installation.

Do not use processed water containing oil, cream or lotion, which is usually found in skin-care shops or massage clinics.

- Otherwise this will cause the packing to be deformed, which causes a malfunction or water leak.

Packing materials can be dangerous to children; keep all packing material (plastic bags, polystyrene, etc.) well out of the reach of children.

A stainless washing tube does not usually rust. However if some metal such as a hair pin is left in the tube for an extended time, the tube could rust.

- Do not leave water or bleach containing chlorine in the tube for an extended period of time.
- Do not regularly use or leave water containing iron in the tube for an extended period of time.
- If rust starts appearing on the surface of the tube, apply a cleansing agent (neutral) to the surface and use a sponge or soft cloth to clean it. (Under no circumstances use a metal brush)

For washing machines with ventilation openings in the base, that a carpet must not obstruct the openings. Use the new hose-sets and old hose-sets should not be reused.

contents

INSTALLING THE WASHING MACHINE

6

- 6 Unpacking the Washing Machine
- 6 Overview of the washing machine
- 7 Selecting a location
- 7 Adjusting the leveling feet
- 7 Removing the shipping bolts
- 8 Connecting the water supply hose (Option)
- 9 Connecting the water supply hose
- 9 Positioning the drain hose
- 9 Environment

WASHING A LOAD OF LAUNDRY

10

- 10 Overview of the control panel
- 12 Washing for the first time
- 13 Putting detergent in the washing machine
- 13 Washing clothes using Fuzzy Logic
- 14 Washing clothes manually
- 14 Using delay start
- 15 Washing tips and hints

MAINTAINING THE WASHING MACHINE

16

- 16 Draining the washing machine in an emergency
- 16 Repairing a frozen washing machine
- 16 Cleaning the exterior
- 17 Cleaning the detergent drawer and recess
- 17 Cleaning the debris filter
- 18 Cleaning the water hose mesh filter

TROUBLESHOOTING

19

- 19 Problems and solutions
- 19 Understanding error messages

PROGRAMME CHART

20

- 20 Programme chart

APPENDIX

21

- 21 Fabric care chart
- 21 Electrical warnings
- 21 Protecting the environment
- 22 Declaration of conformity
- 22 Specification

installing the washing machine

UNPACKING THE WASHING MACHINE

Unpack your washing machine and inspect it for shipping damage. Also make sure that you have received all of the items shown below. If the washing machine was damaged during shipping or you do not have all of the items, contact your Samsung dealer immediately.

OVERVIEW OF THE WASHING MACHINE

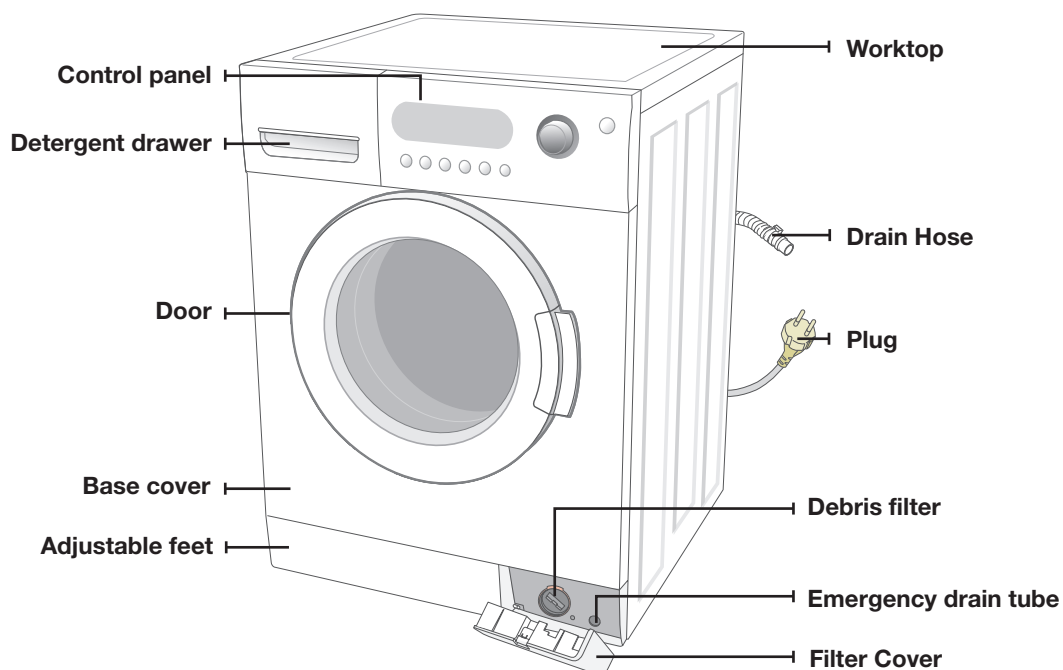

Wrench

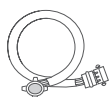

Cold water supply hose



Hose guide

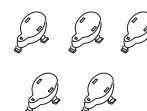

Bolt hole covers

SELECTING A LOCATION

Before you install the washing machine, select a location with the following characteristics:

- A hard, level surface (if the surface is uneven, see “Adjusting the leveling feet,” below)
- Away from direct sunlight.
- Adequate ventilation
- Room temperature that will not fall below 0 °C
- Away from sources of heat such as coal or gas

Make sure that the washing machine does not stand on its power cord.

Ventilation openings must not be obstructed by carpeting when the washing machine is installed on a carpeted floor.

ADJUSTING THE LEVELING FEET

If the floor is uneven, adjust the feet (do not insert pieces of wood or any other objects under the feet):

1. Loosen the leg bolt by turning it with your hand until it is at the desired height.
2. Tighten the locking nut by turning it with the supplied wrench.
 - **Place the washer on a sturdy, flat surface.** If the washer is placed on an uneven or weak surface, noise or vibration occurs. (Only a 1 degrees angle is allowed.)

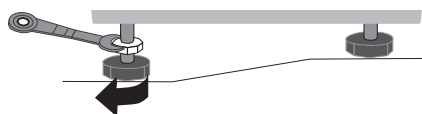

REMOVING THE SHIPPING BOLTS

Before installing the washing machine, you must remove the five shipping bolts from the back of the unit.

1. Loosen all the bolts with the supplied wrench.

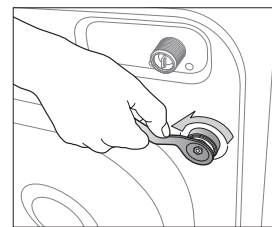

2. Hold the bolt with the spanner and pull it through the wide section of the hole. Repeat for each bolt.

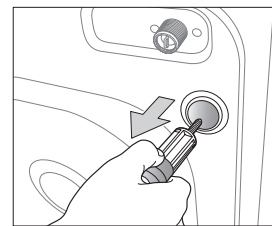

3. Fill the holes with the supplied plastic covers.

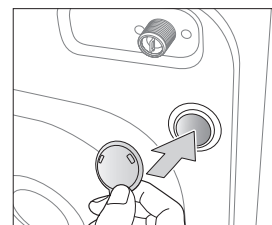

4. Store the shipping bolts away safely in case you have to move the washing machine in the future.



Packaging materials can be dangerous to children; keep all packaging material (plastic bags, polystyrene, etc.) well out of the reach of children.

installing the washing machine

CONNECTING THE WATER SUPPLY HOSE (OPTION)

1. Remove the adaptor from the water supply hose.

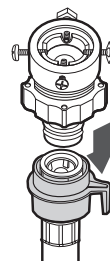

2. First, using a '+' type screw driver, loosen the four screws on the adaptor. Next, take the adaptor and turn part(b) following the arrow until there is a 5mm gap.

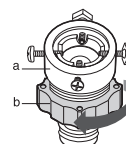

3. Connect adaptor to the water tap by tightening the screws firmly. Then, turn part (b) following the arrow and put (a) and (b) together.

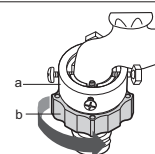

4. Connect the water supply hose to the adaptor. Pull down part (c) of the water supply hose. When you release part (c) the hose automatically connects to the adaptor making a 'click' sound.

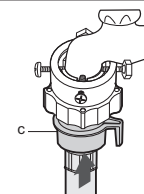

5. Connect the other end of the water supply hose to the inlet water valve at the top of the washer. Screw the hose clockwise all the way in.

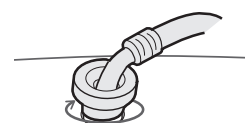

- If the water tap has a screw type faucet, connect the water supply hose to the tap as shown.

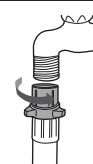

-  After completing connection, if water leaks from the hose, then repeat the same steps. Use the most conventional type of faucet for water supply. In case the faucet is square or too big, remove the spacing ring before inserting the faucet into the adaptor.

CONNECTING THE WATER SUPPLY HOSE

The water supply hose must be connected to the washing machine at one end and to the water faucet at the other. Do not stretch the water supply hose. If the hose is too short and you do not wish to move the water faucet, replace the hose with a longer, high pressure hose.

To connect the water supply hose:

1. Take the L-shaped arm fitting for the cold water supply hose and connect to the cold water supply intake on the back of the machine. Tighten by hand.

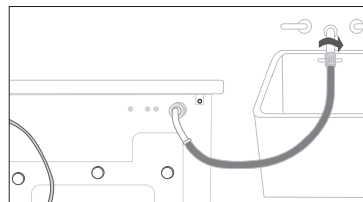

2. Connect the other end of the cold water supply hose to your sink's cold water faucet and tighten it by hand. If necessary, you can reposition the water supply hose at the washing machine end by loosening the fitting, rotating the hose, and retightening the fitting.

Option:

1. Take the red L-shaped arm fitting for the hot water supply hose and connect to the red hot water supply intake on the back of the machine. Tighten by hand.
2. Connect the other end of the hot water supply hose to your sink's hot water faucet and tighten it by hand.
3. Use a Y-piece if you only want to use cold water.

 The appliance is to be connected to the water mains using new hose-sets and that old hose-sets should not be used.

POSITIONING THE DRAIN HOSE

The end of the drain hose may be positioned in three ways:

Over the edge of a sink

The drain hose must be placed at a height of between 60 and 90 cm. To keep the drain hose spout bent, use the supplied plastic hose guide. Secure the guide to the wall with a hook or to the faucet with a piece of string to prevent the drain hose from moving.

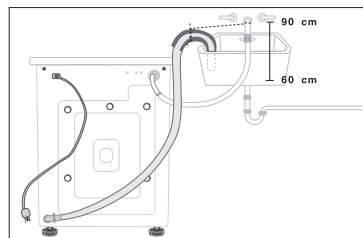

In a sink drain pipe branch

The drain pipe branch must be above the sink siphon so that the end of the hose is at least 60 cm above the ground.

In a drain pipe

Samsung recommends that you use a 65 cm high vertical pipe; it must be no shorter than 60 cm and no longer than 90 cm.

ENVIRONMENT

Please dispose of the packaging materials for this product in an "environmentally friendly" manner. For further detail, please contact your local area authority.

washing a load of laundry

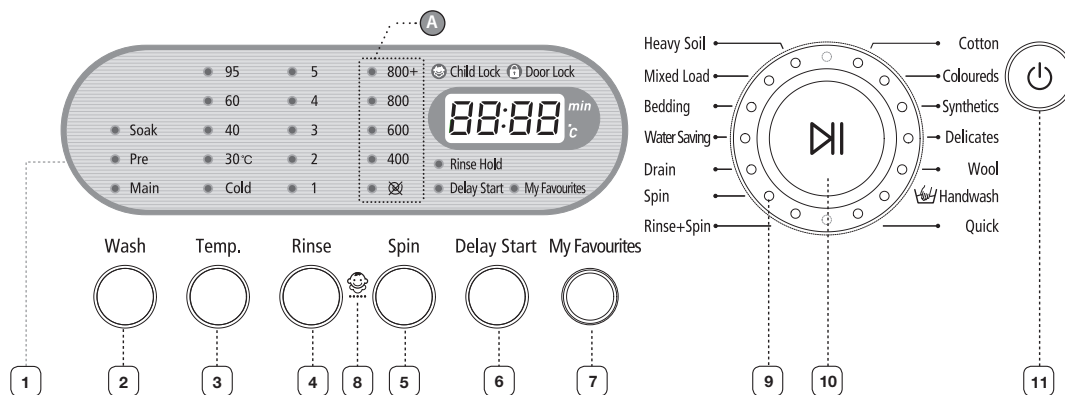

OVERVIEW OF THE CONTROL PANEL



This is a general manual. The INLAY system may be different from that of the product you purchased. For (A), see item 5 below to select the right specifications that match your product.

1	Digital graphic display Displays the remaining wash cycle time, all of washing information and error messages.								
2	Wash selection button Press the button to select wash. Wash is available only with Baby Cotton, Heavy Soil, Mixed Load, Water Saving, Cotton, Coloureds, Synthetics, Delicates.								
3	Temperature selection button Press the button repeatedly to cycle through the available water temperature options (cold water (☹), 30 °C, 40 °C , 60 °C and 95 °C).								
4	Rinse selection button Press the rinse button to add rinse cycles. Maximum number of rinse cycles is five.								
5	<p>Press the button repeatedly to cycle through the available spin speed options.</p> <table border="1" data-bbox="457 1248 1276 1479"> <tr> <td data-bbox="457 1248 851 1295">WF7704N6/WF7604N6</td> <td data-bbox="851 1248 1276 1295">Rinse hold, ☹, 400, 800, 1200, 1400 rpm</td> </tr> <tr> <td data-bbox="457 1295 851 1351">WF7702N6/WF7602N6/WF7522N6/ WF7452N6</td> <td data-bbox="851 1295 1276 1351">Rinse hold, ☹, 400, 800, 1000, 1200 rpm</td> </tr> <tr> <td data-bbox="457 1351 851 1406">WF7700N6/WF7600N6/WF7520N6/ WF7450N6/WF7350N6</td> <td data-bbox="851 1351 1276 1406">Rinse hold, ☹, 400, 600, 800, 1000 rpm</td> </tr> <tr> <td data-bbox="457 1406 851 1479">WF7708N6/WF7608N6/WF7528N6/ WF7458N6/WF7358N6</td> <td data-bbox="851 1406 1276 1479">Rinse hold, ☹, 400, 600, 800, 800+ rpm</td> </tr> </table> <p>No spin - The laundry remains wet without spinning after final Rinse. Rinse Hold - The laundry remains soaking in the final rinse water. Before the laundry can be unloaded, either "Drain" or the "Spin" program must be run.</p>	WF7704N6/WF7604N6	Rinse hold, ☹, 400, 800, 1200, 1400 rpm	WF7702N6/WF7602N6/WF7522N6/ WF7452N6	Rinse hold, ☹, 400, 800, 1000, 1200 rpm	WF7700N6/WF7600N6/WF7520N6/ WF7450N6/WF7350N6	Rinse hold, ☹, 400, 600, 800, 1000 rpm	WF7708N6/WF7608N6/WF7528N6/ WF7458N6/WF7358N6	Rinse hold, ☹, 400, 600, 800, 800+ rpm
WF7704N6/WF7604N6	Rinse hold, ☹, 400, 800, 1200, 1400 rpm								
WF7702N6/WF7602N6/WF7522N6/ WF7452N6	Rinse hold, ☹, 400, 800, 1000, 1200 rpm								
WF7700N6/WF7600N6/WF7520N6/ WF7450N6/WF7350N6	Rinse hold, ☹, 400, 600, 800, 1000 rpm								
WF7708N6/WF7608N6/WF7528N6/ WF7458N6/WF7358N6	Rinse hold, ☹, 400, 600, 800, 800+ rpm								
6	Delay Start selection button Press the button repeatedly to cycle through the available delayed start options (from 3 hour to 24 hours in one hour increments). Displayed hours means the time of finished washing-cycle.								
7	My Favourite selection button My Favourite button is very simple so that you can use it very easily. Press the Power button, then press the My Favourite button, and then turn the dial to the Wash Program. Select the washing way which is frequently used, for example, rinse cycle, water temperature, and spin cycles. This way the settings are saved. If you select the Wash Program for your next wash, you can wash your clothes as the same way as just previous one.								



10_ Installing the washing machine

<p>8 Child Lock selection button</p>	<p>This is a button for preventing children from manipulating the washing machine.</p> <p>On/Off - To set the program on: Press the Start/Pause button to turn on the washing machine.</p> <p>Press and hold down the [Rinse] + [Spin] button for 2-3 seconds. It can only be activated when the machine is turned on. Once you set the Child Lock function while in washing, no button is activated until you set it off. Only POWER button can activate. The Child Lock lamp lights on and off. To set the program off: Press and hold down the [Rinse] + [Spin] button again for 2-3 seconds, then the lamp lights off and is set off.</p> <p> Check out the Baby Program button first when no button is activated while the washing machine is working.</p>
<p>9 Fuzzy Control dial</p>	<p>Turn the dial to select one of the 14 available wash programs.</p> <p>Cotton, Coloureds, Synthetics, Delicates, Wool, Hand wash, Quick, Rinse+Spin, Spin, Drain, Heavy Soil, Mixed Load, Bedding, Water Saving.</p>
<p>10 Start/Pause selection button</p>	<p>Press to pause and restart programs.</p> <p>Press the Start/Pause button before adding the laundry. This can only be selected within 5 minutes of the start.</p>
<p>11  (On/Off) selection button</p>	<p>Press once to turn the washing machine on, press again to turn the washing machine off. If the washing machine power is left on for longer than 10 minutes without any buttons being touched, the power automatically turns off.</p>

washing a load of laundry

WASHING FOR THE FIRST TIME

Before washing clothes for the first time, you must run a complete cycle without clothes.

1. Press the  (On/Off) button.
2. Pour a little detergent into compartment  in the detergent drawer.
3. Turn on the water supply to the washing machine.
4. Press the Temperature button repeatedly until 40 °C is displayed.
5. Press the Start/Pause button.
 - This will remove any water from the manufacturer's test run remaining in the machine.

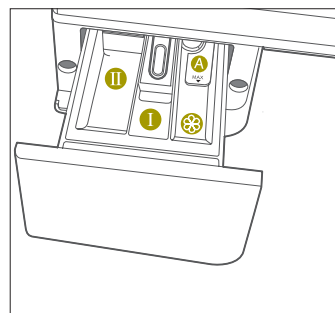
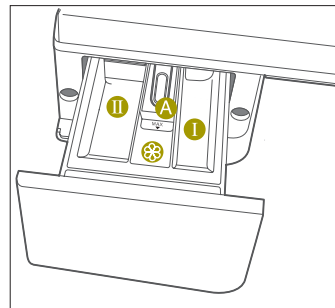

Dispenser : Detergent for prewash or starch.

Dispenser : Detergent for main wash, water softener, pre-soaking agent, bleach and stain removal product.

Dispenser : Additives, e.g. fabric softener or former (fill no higher than lower edge of insert "A")

PUTTING DETERGENT IN THE WASHING MACHINE

1. Pull out the detergent drawer.
2. Add laundry detergent into compartment (II).
3. Add softener into compartment (⊗) (if you desire).
4. Add prewash detergent into compartment (I) (if you desire).



Concentrated or thick fabric softener and conditioner must be diluted with a little water before being poured into the dispenser (prevents the overflow from becoming blocked).

When using dry detergent it is recommended to pre dissolve the dry powder in some warm water before adding to the detergent dispenser or tub.

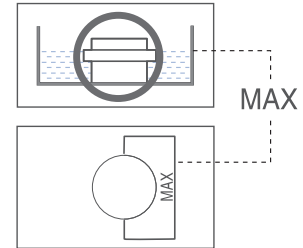

WASHING CLOTHES USING FUZZY LOGIC

Your new washing machine makes washing clothes easy, using Samsung's "Fuzzy Logic" automatic control system. When you select a wash programme, the machine will set the correct temperature, washing time, and washing speed.

To wash clothes using the Fuzzy Logic programs:

1. Turn on your sink's water faucet.
2. Press the (On/Off) button.
3. Open the door.
4. Load the articles one at a time loosely into the drum, without overfilling.
5. Close the door.
6. Add the detergent, softener, and prewash detergent (if necessary) into the appropriate compartment.

 Wash is only available when washing Duvet, Bedding, Towel, Curtain, Cotton, Coloureds, Synthetics and Delicates programs. It is only necessary if your clothing is heavily soiled.

7. Turn the Fuzzy Control dial to select the appropriate program for the type of clothes Cotton, Coloureds, Synthetics, Delicates, Wool, Handwash, Quick, Rinse+Spin, Spin, Drain, Heavy Soil, Mixed Load, Bedding, Water Saving.

You will see the indicators light up on the control panel.

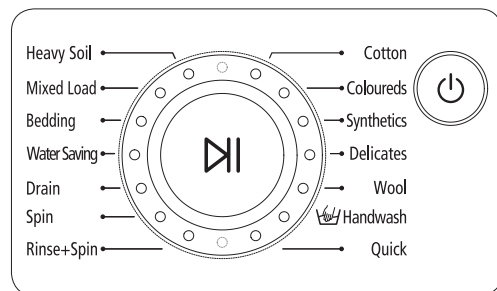

8. At this time, you can control the washing type, wash temperature, Rinse times, spin speed, delay time by pressing the appropriate option button.
9. Press the Start/Pause button on the Fuzzy Control dial and the wash cycle will begin. The process indicator will light up and the remaining time for the cycle will appear in the display.

When the cycle is finished:

After the total cycle has finished, the power will turn off automatically.

1. Open the door.

 The door will not open until 3 minutes after the machine stops or the power turns off.
2. Remove laundry.

washing a load of laundry

WASHING CLOTHES MANUALLY

You can wash clothes manually without using the Fuzzy Logic feature.

To do so:

1. Turn the water supply on.
2. Press the (⏻) (On/Off) button on the washing machine.
3. Open the door.
4. Load the articles one at a time loosely into the drum, without overfilling.
5. Close the door.
6. Put the detergent and, if necessary, softener or prewash detergent, in the appropriate compartments.
7. Press the Temperature button to select the temperature.
(cold water, 30°C, 40°C, 60°C, 95°C)
8. Press to rinse button to select the required number of rinse cycles.
Maximum number of rinse cycles is five.
The washing duration will be prolonged accordingly.
9. The rinse hold program allows you to take clothes that are dripping wet out of the washing machine.
⊗: No Spin
10. Press the button repeatedly to cycle through the available delayed start options (from 3 hour to 24 hours in one hour increments). Displayed hours means the time of finished washing-cycle.
11. Press the Start/Pause button and the machine will begin the cycle.

USING DELAY START

You can set the washing machine to finish your wash automatically at a later time, choosing from 3 to 24 hour delay (in 1 hour increments). Displayed hours means the time of finished washing-cycle.

To do this:

1. Manually or automatically set your washing machine for the type of clothes you are washing.
2. Press the **Delay Start** button repeatedly until the delay time is set.
3. Press the **Start/Pause** (⏻) button. The Delay Start indicator will light, and the clock will begin counting down until it reaches your finish time.
4. To cancel Delay Start, press the (On/Off) button, then turn the washing machine on again.

WASHING TIPS AND HINTS

Sorting your laundry: Sort your laundry according to the following characteristics:

- **Type of fabric care label symbol:** Sort laundry into cottons, mixed fibers, synthetics (Δ), silks, wools and rayon.
- **Colour:** Divide whites and colours. Wash new, coloured items separately.
- **Size:** Placing items of different sizes in the same load will improve the washing action.
- **Sensitivity:** Wash delicate items separately, using the Delicate wash programme for pure new wool, curtains and silk articles. Check the labels on the items you are washing or refer to the fabric care chart in the appendix.

Emptying pockets: Coins, safety pins and similar items can damage linen, the washing machine drum, and the water tank.

Securing fasteners: Close zippers and fasten buttons or hooks; loose belts or ribbons should be tied together.

Prewashing cotton: Your new washing machine, combined with modern detergents, will give perfect washing results, thus saving energy, time, water and detergent. However, if your cotton is particularly dirty, use a prewash with a protein-based detergent.

Determining load capacity: Do not overload the washing machine or your laundry may not wash properly. Use the chart below to determine the load capacity for the type of laundry you are washing.

Fabric Type		Load Capacity				
		WF7704N6/ WF7702N6/ WF7700N6/ WF7708N6	WF7604N6/ WF7602N6/ WF7600N6/ WF7608N6	WF7522N6/ WF7520N6/ WF7528N6	WF7452N6/ WF7450N6/ WF7458N6	WF7350N6/ WF7358N6
Coloured/ cotton	average/ lightly soiled	7.0 kg	6.0 kg	5.2 kg	4.5 kg	3.5 kg
	heavily soiled	7.0 kg	6.0 kg	5.2 kg	4.5 kg	3.5 kg
Synthetics		3.0 kg	3.0 kg	2.5 kg	2.5 kg	2.0 kg
Delicate		2.5 kg	2.5 kg	2.0 kg	2.0 kg	1.5 kg
Wool		2.0 kg	2.0 kg	1.5 kg	1.5 kg	1.5 kg

Detergent tips: The type of detergent you should use is based on the type of fabric (cotton, synthetic, delicate items, wool), colour, wash temperature, degree and type of soiling.

Always use "low suds" laundry soap, which is designed for automatic washing machines.

Follow the detergent manufacturer's recommendations based upon the weight of the laundry, the degree of soiling, and the hardness of the water in your area. If you do not know how hard your water is, ask your water authority.

Keep detergents and additives in a safe, dry place out of the reach of children.

maintaining the washing machine

DRAINING THE WASHING MACHINE IN AN EMERGENCY

1. Unplug the washing machine from the power supply.
2. Open the filter-cover by using a coin or a key.

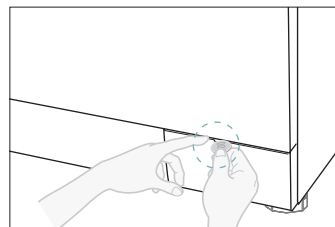

3. Unscrew the emergency drain cap by turning left. Grip the cap on the end of the emergency drain tube and slowly pull it out about 15 cm.
4. Allow all the water to flow into a bowl.
5. Reinsert the drain tube and screw the cap back on.
6. Replace the filter-cover.

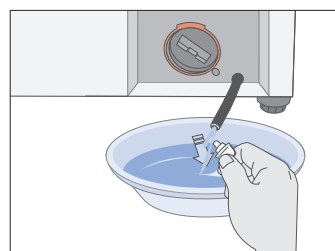

REPAIRING A FROZEN WASHING MACHINE

If the temperature drops below freezing and your washing machine is frozen:

1. Unplug the washing machine.
2. Pour warm water on the source faucet to loosen the water supply hose.
3. Remove the water supply hose and soak it in warm water.
4. Pour warm water into the washing machine drum and let it sit for 10 minutes.
5. Reconnect the water supply hose to the water faucet and check if the water supply and drain operations are normal.

CLEANING THE EXTERIOR

1. Wipe the washing machine surfaces, including the control panel, with a soft cloth and nonabrasive household detergents.
2. Use a soft cloth to dry the surfaces.
3. Do not pour water on the washing machine.

CLEANING THE DETERGENT DRAWER AND RECESS

1. Press the release lever on the inside of the detergent drawer and pull it out.
2. Remove the cap from compartment (⊗).
3. Wash all of the parts under running water.
4. Clean the drawer recess with an old toothbrush.
5. Reinsert the cap (Pushing it firmly into place) and replace the liquid detergent divider into the drawer.
6. Push the drawer back into place.
7. Run a rinse programme without any laundry in the drum.

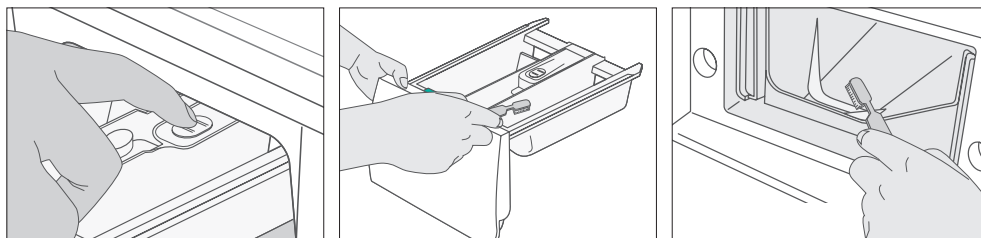

CLEANING THE DEBRIS FILTER

Clean the debris filter 5 or 6 times a year, or when you see the following error message on the display:

5E

1. Open the filter-cover, see “Draining the washing machine in an emergency” on page 16.
2. Unscrew emergency drain cap by turning left and drain off all the water.
See “Draining the washing machine in an emergency” on page 16.
3. Unscrew the filter cap and take it out.
4. Wash any dirt or other material from the filter. Make sure the drain pump propeller behind the filter is not blocked. Replace the filter cap.
5. Replace the filter-cover.

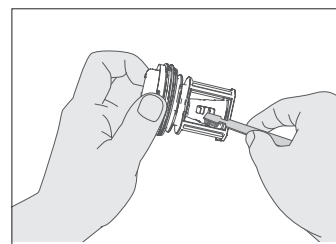

maintaining the washing machine

CLEANING THE WATER HOSE MESH FILTER

You should clean the water hose mesh filter at least one time per year, or when you see the following error message on the display:

4E

To do this:

1. Turn off the water source to the washing machine.
2. Unscrew the hose from the back of the washing machine.
3. With a pair of pliers, gently pull out the mesh filter from the end of the hose and rinse it under water until clean. Also clean the inside and outside of the threaded connector.
4. Push the filter back into place.
5. Screw the hose back onto the washing machine.
6. Turn on the faucet and make sure the connections are watertight.

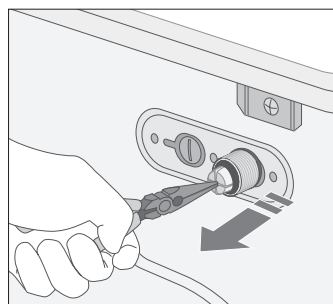
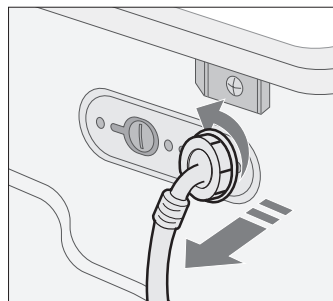

troubleshooting

PROBLEMS AND SOLUTIONS

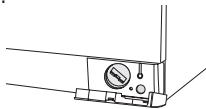
PROBLEM	SOLUTION
The washing machine will not start	<ul style="list-style-type: none"> • Make sure the door is firmly closed. • Make sure the washing machine is plugged in. • Make sure the water source faucet is turned on. • Make sure to press the Start/Pause button.
No water or insufficient water supply	<ul style="list-style-type: none"> • Make sure the water source faucet is turned on. • Make sure the water source hose is not frozen. • Make sure the water intake hose is not bent. • Make sure the filter on the water intake hose is not clogged.
Detergent remains in the detergent drawer after the wash program is complete	<ul style="list-style-type: none"> • Make sure the washing machine is running with sufficient water pressure. • Put the detergents in the inner parts of the detergent drawer (away from the outside edges).
Washing machine vibrates or is too noisy	<ul style="list-style-type: none"> • Make sure the washing machine is set on a level surface. If the surface is not level, adjust the washing machine feet to level the appliance. • Make sure that the shipping bolts are removed. • Make sure the washing machine is not touching any other object. • Make sure the laundry load is balanced.
The washing machine does not drain and/or spin	<ul style="list-style-type: none"> • Make sure the drain hose is not squashed or bent. • Make sure the water hose mesh filter is not clogged.
The Door does not open	<ul style="list-style-type: none"> • Disconnect the power plug from the power supply. • Remove the water from the washing machine. • Open the filter cover using a coin. • Locate the orange plastic tab and pull forward to open the door. ; Except 800rpm models as WF7708N6(W/V/S/C/R), 7608N6(W/V/S/C/R), 7528N6(W/V/S/C/R), 7458N6(W/V/S/C/R) ,7358N6(W/V/S/C/R) • The door will not open until 3 minutes after the machine stops or the power turns off. ; Only 800rpm models as WF7708N6(W/V/S/C/R), 7608N6(W/V/S/C/R), 7528N6(W/V/S/C/R), 7458N6(W/V/S/C/R), 7358N6(W/V/S/C/R) 

UNDERSTANDING ERROR MESSAGES

ERROR CODE	SOLUTION
dE	<ul style="list-style-type: none"> • Close the door.
4E	<ul style="list-style-type: none"> • Make sure the source water faucet is turned on. • Check the water pressure.
5E	<ul style="list-style-type: none"> • Clean the debris filter. • Make sure the drainage hose is installed correctly.
UE	<ul style="list-style-type: none"> • Laundry load is unbalanced; loosen any tangled laundry. If only one item of clothing needs washing, such as a bathrobe or jeans, the final spin result might be unsatisfactory and an "UE" error message will be shown in the display window.
cE/3E	<ul style="list-style-type: none"> • Call after-sales service.

Before contacting After-Sales service:

1. Try to remedy the problem (See "Troubleshooting" on this page).
2. Restart the programme to see if the fault is repeated.
3. If the malfunction persists, call after-sales service and describe the problem.

programme chart

PROGRAMME CHART

(● user option)

Program	Max Load(kg)					Detergent and additives			Temp (Max)
	WF 7704N6/ 7702N6/ 7700N6/ 7708N6	WF 7604N6/ 7602N6/ 7600N6/ 7608N6	WF 7522N6/ 7520N6/ 7528N6	WF 7452N6/ 7450N6/ 7458N6	WF 7350N6/ 7358N6	Pre-Wash	Wash	Softener	
Cotton	7.0	6.0	5.2	4.5	3.5	●	yes	●	95
Coloureds	7.0	6.0	5.2	4.5	3.5	●	yes	●	60
Synthetics	3.0	3.0	2.5	2.5	2.0	●	yes	●	60
Delicates	2.5	2.5	2.0	2.0	1.5	●	yes	●	40
Wool	2.0	2.0	1.5	1.5	1.5	-	yes	●	40
Handwash	2.0	2.0	1.5	1.5	1.5	-	yes	●	40
Quick	3.0	3.0	2.0	2.0	1.5	-	yes	●	60
Heavy Soil	7.0	6.0	5.2	4.5	3.5	●	yes	●	60
Mixed Load	7.0	6.0	5.2	4.5	3.5	●	yes	●	60
Bedding	2.5	2.5	2.0	2.0	1.5	●	yes	●	95
Water Saving	7.0	-	-	-	-	●	yes	●	95

Program	Spin Speed (Max) rpm				Delay Start	Cycle Time (min)		
	WF 7704N6/ 7604N6	WF 7702N6/ 7602N6/ 7522N6/ 7452N6	WF 7700N6/ 7600N6/ 7520N6/ 7450N6/ 7350N6	WF 7708N6/ 7608N6/ 7528N6/ 7458N6/ 7358N6		WF 7704N6/7702N6/7700N6/ 7708N6/7604N6/7602N6/ 7600N6/7608N6/7522N6/ 7520N6/7528N6/7452N6/ 7450N6/7458N6/7350N6/ 7358N6	WF 7708N6W1	WF 7700N6W1
Cotton	1400	1200	1000	800+	●	143	143	143
Coloureds	1400	1200	1000	800+	●	98	98	98
Synthetics	800	800	800	800	●	70	70	70
Delicates	800	800	600	600	●	53	53	53
Wool	400	400	400	400	●	41	41	41
Handwash	400	400	400	400	●	36	36	36
Quick	1400	1200	1000	800+	●	28	28	28
Heavy Soil	1400	1200	1000	800+	●	108	108	108
Mixed Load	800	800	800	800	●	76	76	76
Bedding	1400	1200	1000	800+	●	98	98	98
Water Saving	-	-	1000	800+	●	164	194	214































The "Water Saving" program is recommended for a normally soiled cotton load.

1. Programme with prewash lasts approx. 15 minutes longer.
2. The programme duration data has been measured under the conditions specified in Standard IEC 60456 / EN 60456.
3. Consumption in individual homes may differ from the values given in the table due to variations in the pressure and temperature of the water supply, the load and the type of laundry.

20_ Programme chart

appendix

FABRIC CARE CHART

 Resistant material	 Can be ironed at 100°C max
 Delicate fabric	 Do not iron
  Item may be washed at 95°C	 Can be dry cleaned using any solvent
  Item may be washed at 60°C	 Dry clean with perchloride, lighter fuel, pure alcohol or R113 only
  Item may be washed at 40°C	 Dry clean with aviation fuel, pure alcohol or R113 only
  Item may be washed at 30°C	 Do not dry clean
 Item may be hand washed	 Dry flat
 Dry clean only	 Can be hung to dry
 Can be bleached in cold water	 Dry on clothes hanger
 Do not bleach	 Tumble dry, normal heat
 Can be ironed at 200°C max	 Tumble dry, reduced heat
 Can be ironed at 150°C max	 Do not tumble dry

ELECTRICAL WARNINGS

To reduce the risk of fire, electrical shock, and other injuries, keep these safety precautions in mind:

- Operate the appliance only from the type of power source indicated on the marking label. If you are not sure of the type of power supplied to your home, consult your appliance dealer or local power company.
- Use only a grounded or polarized outlet. This plug will fit into the power outlet only one way. If you are unable to insert the plug fully into the outlet, try reversing the plug. If the plug still doesn't fit, contact your electrician to replace your outlet.
- Protect the power cord. Power supply cords should be routed so that they are unlikely to be walked on or pinched by items placed on or against them. Pay particular attention to cords at plugs, convenience receptacles, and the point where they exit from the unit.
- Do not overload the wall outlet or extension cords. Overloading can result in fire or electric shock.

PROTECTING THE ENVIRONMENT

- This appliance is manufactured from recyclable materials. If you decide to dispose of this appliance, please observe local waste disposal regulations. Cut off the power cord so that the appliance cannot be connected to a power source. Remove the door so that animals and small children cannot get trapped inside the appliance.
- Do not exceed the detergent quantities recommended in the detergent manufacturers' instructions.
- Use stain removal products and bleaches before the wash cycle only when strictly necessary.
- Save water and electricity by only washing full loads (the exact amount depends upon the program used).

appendix

DECLARATION OF CONFORMITY

This appliance complies with European safety standards, EC directive 93/68 and EN Standard 60335.

SPECIFICATION

TYPE		FRONT LOADING WASHER								
DIMENSIONS	WF7704N6/WF7702N6/ WF7700N6/WF7708N6				WF7604N6/WF7602N6/ WF7600N6/WF7608N6					
	W598mm × D550mm × H844mm				W598mm × D550mm × H844mm					
WATER PRESSURE		50 kPa ~ 800 kPa								
WATER VOLUME		60 ℓ				54 ℓ				
NET WEIGHT		79 kg				78 kg				
WASH and SPIN CAPACITY		7 kg (Dry Laundry)				6 kg (Dry Laundry)				
POWER CONSUMPTION	WASHING AND HEATING	220V		2000W		220V		2000W		
		240V		2400W		240V		2400W		
	SPIN	MODEL	WF 7704N6	WF 7702N6	WF 7700N6	WF 7708N6	WF 7604N6	WF 7602N6	WF 7600N6	WF 7608N6
		230 V	700W	360W	320W	270W	580W	530W	500W	430W
PUMPING		34 W								
PACKAGE WEIGHT	PAPER	2.5 kg				2.5 kg				
	PLASTIC	1.0 kg				1.0 kg				
SPIN REVOLUTION	MODEL	WF7704N6/WF7604N6				WF7702N6/WF7602N6/ WF7522N6/WF7452N6				
	rpm	1400				1200				

TYPE		FRONT LOADING WASHER									
DIMENSIONS		WF7522N6/ WF7520N6/WF7528N6			WF7452N6/ WF7450N6/WF7458N6			WF7350N6/ WF7358N6			
		W598mm × D450mm × H844mm			W598mm × D404mm × H844mm			W598mm × D340mm × H844mm			
WATER PRESSURE		50 kPa ~ 800 kPa									
WATER VOLUME		49 ℓ			48 ℓ			43 ℓ			
NET WEIGHT		69 kg			62 kg			55 kg			
WASH and SPIN CAPACITY		5.2 kg (Dry Laundry)			4.5 kg (Dry Laundry)			3.5 kg (Dry Laundry)			
POWER CONSUMP- TION		WASHING AND HEATING		220V		1900W		220V		1800W	
				240V		2200W		240V		2100W	
		SPIN	MODEL	WF 7522N6	WF 7520N6	WF 7528N6	WF 7452N6	WF 7450N6	WF 7458N6	WF 7350N6	WF 7358N6
			230 V	550W	500W	430W	270W	230W	180W	250W	200W
PUMPING		34 W									
PACKAGE WEIGHT		PAPER		2.1 kg		1.9 kg		1.8 kg			
		PLASTIC		0.9 kg		0.8 kg		0.8 kg			
SPIN REVOLUTION		MODEL		WF7702N6/WF7602N6/ WF7522N6/WF7452N6			WF7700N6/ WF7600N6/WF7520N6/ WF7450N6/WF7350N6		WF7708N6/ WF7608N6/ WF7528N6/ WF7458N6/ WF7358N6		
		rpm		1200			1000		800		



QUESTIONS OR COMMENTS?

Country	CALL	OR VISIT US ONLINE AT
AUSTRALIA	1300 362 603	www.samsung.com/au

Code No. DC68-02375E-05_EN