

WD6122CKC  
WD6122CKS

# Washing Machine user manual

imagine the possibilities

Thank you for purchasing a Samsung product.  
To receive a more complete service,  
please register your product at  
[www.samsung.com/global/register](http://www.samsung.com/global/register)

**SAMSUNG**

# features

---

## **1. Air wash**

Air wash can remove any bad smells from the laundry or reduce the need for dry cleaning.

- × Mite sterilization: Sterilizes any bacteria or mites in the bedding where the water-wash is not effective.

## **2. Silver nano (Ag+) anti-bacteria, sterilization system**

Protects your skin and keeps the interior clean and pleasant by removing bacteria from the laundry and adding a silver-nano coating to it.

## **3. Washing to drying with one button**

We can select the drying time manually. The machine features an auto sensor of the optimal dry state that enables you to perform the whole wash cycle including the drying cycle using one button.

# safety information

---

Throughout this manual, you'll see Warning and Caution notes.



These warnings, cautions, and the important safety instructions that follow do not cover all possible conditions and situations that may occur.

It's your responsibility to use common sense, caution, and care when installing, maintaining, and operation your washer. Samsung is not liable for damages resulting from improper use.

## IMPORTANT SAFETY SYMBOLS AND PRECAUTIONS

---

What the icons and signs in this user manual means:

 <b>WARNING</b>	Hazards or unsafe practices that may result in <b>severe personal injury or death</b> .
 <b>CAUTION</b>	Hazards or unsafe practices that may result in <b>minor personal injury or property damage</b> .
 <b>CAUTION</b>	To reduce the risk of fire, explosion, electric shock, or personal injury when using your washer, follow these basic safety precautions:

## BEFORE USING THE APPLIANCE

---

 Packing materials can be dangerous to children; keep all packing material (plastic bags, polystyrene, etc.) well out of the reach of children.

The appliance is designed for home use only.

Make sure that water and electrical connections are made by qualified technicians, observing the manufacturer's instructions (see "Installing the Washing Machine") and local safety regulations.

All packaging and shipping bolts must be removed before the appliance is used. Serious damage may occur if they are not removed. See "Removing the shipping bolts".

Before washing clothes for the first time, you must run a complete cycle without clothes. See "Washing for the first time".

## SAFETY INSTRUCTIONS

---

 Before cleaning or carrying out maintenance, unplug the appliance from the electrical outlet or set the **Power** button to Off.

Make sure that the pockets of all clothing to be washed are empty. Hard, sharp objects, such as coins, safety pins, nails, screws, or stones can cause extensive damage to the appliance.

Always unplug the appliance and turn off the water after use.

Before you open the door of the appliance, check that the water has drained. Do not open the door if you can still see water.

Pets and small children may climb into the appliance. Check the appliance before each use.

# safety information

---

The glass door becomes very hot during the washing cycle. Keep children away from the appliance while it is in use.

Do not attempt to repair the appliance yourself. Repairs made by inexperienced or unqualified persons may cause injury and/or make more serious repairs to the appliance necessary.

If the plug (power supply cord) is damaged, it must be replaced by the manufacturer or its service agent or a similar qualified person in order to avoid a hazard.

This appliance should only be serviced by an authorized service center, and only genuine spare parts should be used.

This appliance is not intended for use by young children or infirm persons unless they have been adequately supervised by a responsible person to ensure that they can use the appliance safely. Young children should be supervised to ensure that they do not play with the appliance.

If this appliance is supplied from a cord extension set or an electrical portable outlet device, the cord extension set or electrical portable outlet device must be positioned so that it is not subject to splashing or ingress of moisture. Additionally, the cord extension set or electrical portable outlet device must be of a current rating suitable for the appliance.

This appliance has to be connected to the plug endurable to proper power consumption.

This appliance has to be positioned so that the plug is accessible after installation.

Do not use processed water containing oil, cream or lotion, which is usually found in skin-care shops or massage clinics.

- Otherwise this will cause the packing to be deformed, which causes a malfunction or water leak.

A stainless washing tube does not usually rust. However if some metal such as a hair pin is left in the tube for an extended time, the tube could rust.

- Do not leave water or bleach containing chlorine in the tube for an extended period of time.
- Do not regularly use or leave water containing iron in the tube for an extended period of time.
- If rust starts appearing on the surface of the tube, apply a cleansing agent (neutral) to the surface and use a sponge or soft cloth to clean it. (Under no circumstances use a metal brush)

For washing machines with ventilation openings in the base, that a carpet must not obstruct the openings.

Use the new hose-sets and old hose-sets should not be reused.

The dryer is not to be used if chemicals have been used for cleaning.

# contents

---

<b>INSTALLING THE WASHING MACHINE</b>	<b>6</b>	Unpacking the Washing Machine
	6	Overview of the washing machine
	7	Selecting a location
	7	Adjusting the leveling feet
	7	Removing the shipping bolts
	8	Connecting the water supply hose
	8	Connecting the water supply hose (Option)
	9	Positioning the drain hose
	10	Plugging in the machine
<b>WASHING A LOAD OF LAUNDRY</b>	<b>11</b>	Washing for the first time
	11	Putting detergent in the washing machine
	12	Overview of the control panel
	13	For the Silver Wash washing
	14	Childlock (button lock function)
	14	Washing clothes manually
	15	Washing clothes using Fuzzy Logic
	16	Using Dry course
	16	Using delay start
	17	To Add Laundry
	17	Using Clean Tub
	18	Performing Air Wash
	19	Washing tips and hints
<b>MAINTAINING THE WASHING MACHINE</b>	<b>20</b>	Draining the washing machine in an emergency
	20	Repairing a frozen washing machine
	20	Cleaning the exterior
	21	Cleaning the detergent drawer and recess
	21	Cleaning the debris filter
	22	Cleaning the water hose mesh filter
<b>TROUBLESHOOTING</b>	<b>23</b>	Problems and solutions
	24	Understanding error messages
<b>PROGRAMME CHART</b>	<b>25</b>	Programme chart
<b>APPENDIX</b>	<b>26</b>	Fabric care chart
	26	Electrical warnings
	26	Protecting the environment
	27	Declaration of conformity
	27	Specification

# installing the washing machine

## UNPACKING THE WASHING MACHINE

Unpack your washing machine and inspect it for shipping damage. Also make sure that you have received all of the items shown below. If the washing machine was damaged during shipping or you do not have all of the items, contact your Samsung dealer immediately.

## OVERVIEW OF THE WASHING MACHINE

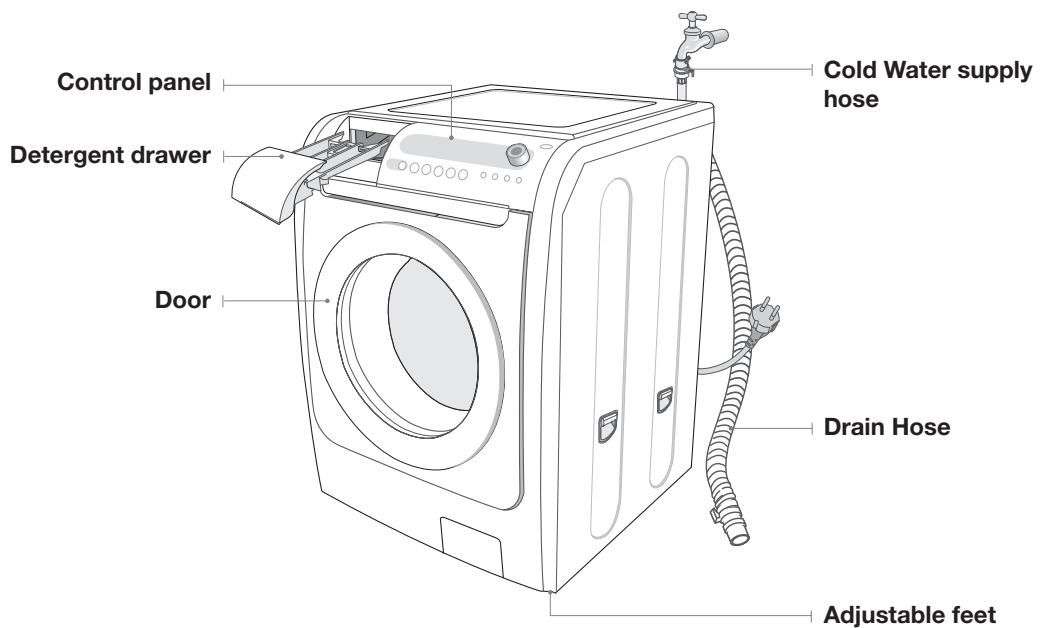

Wrench



Water supply hose

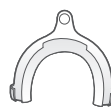

Hose guide

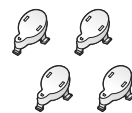

Bolt hole covers

## SELECTING A LOCATION

Before you install the washing machine, select a location with the following characteristics:

- A hard, level surface (if the surface is uneven, see “Adjusting the leveling feet,” below)
- Away from direct sunlight.
- Adequate ventilation
- Room temperature that will not fall below 0°C
- Away from sources of heat such as coal or gas

Make sure that the washing machine does not stand on its power cord.

Ventilation openings must not be obstructed by carpeting when the washing machine is installed on a carpeted floor.

## ADJUSTING THE LEVELING FEET

If the floor is uneven, adjust the feet (do not insert pieces of wood or any other objects under the feet):

1. Loosen the leg bolt by turning it with your hand until it is at the desired height.
2. Tighten the locking nut by turning it with a (-) screwdriver.

If the washer is placed on an uneven or weak surface, noise or vibration occurs.

(Only a 1 degree angle is allowed.)

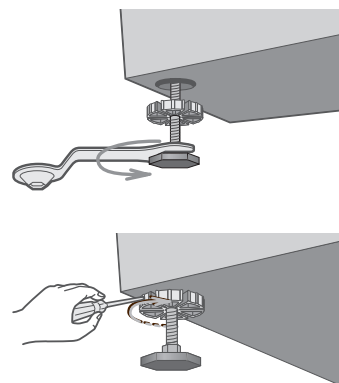

## REMOVING THE SHIPPING BOLTS

Before using the washing machine, you must remove the four shipping bolts from the back of the unit. To remove the bolts:

1. Loosen all bolts with the wrench before removing them.
2. Take each bolt head and pull it through the wide part of the hole.  
Repeat for each bolt.
3. Fill the holes with the supplied plastic covers.
4. Keep the shipping bolts for future use.

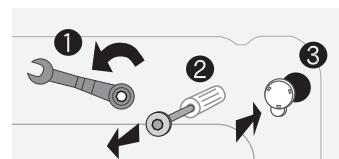

# installing the washing machine

## CONNECTING THE WATER SUPPLY HOSE

The water supply hose must be connected to the washing machine at one end and to the water faucet at the other. Do not stretch the water supply hose. If the hose is too short replace the hose with a longer, high pressure hose.

### To connect the water supply hose:

1. Take the L-shaped arm fitting for the cold water supply hose and connect to the cold water supply intake on the back of the machine. Tighten by hand.
2. Connect the other end of the cold water supply hose to your sink's cold water faucet and tighten it by hand. If necessary, you can reposition the water supply hose at the washing machine end by loosening the fitting, rotating the hose, and retightening the fitting.

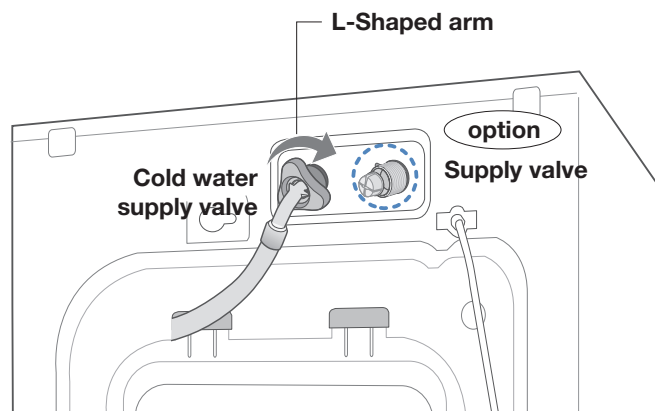

### Option :

1. Take the red L-shaped arm fitting for the hot water supply hose and connect to the red hot water supply intake on the back of the machine. Tighten by hand.
2. Connect the other end of the hot water supply hose to your sink's hot water faucet and tighten it by hand.

## CONNECTING THE WATER SUPPLY HOSE (OPTION)

1. Remove the adaptor from the water supply hose.

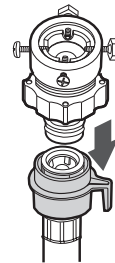

2. First, using a '+' type screw driver, loosen the four screws on the adaptor. Next, take the adaptor and turn part(b) following the arrow until there is a 5mm gap.

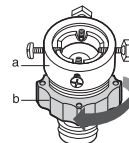



3. Connect adaptor to the water tap by tightening the screws firmly. Then, turn part (b) following the arrow and put (a) and (b) together.

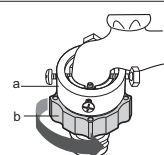

4. Connect the water supply hose to the adaptor. Pull down part (c) of the water supply hose. When you release part (c) the hose automatically connects to the adaptor making a 'click' sound.

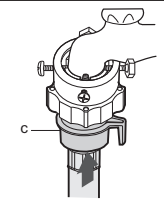

5. Connect the other end of the water supply hose to the inlet water valve at the top of the washer. Screw the hose clockwise all the way in.

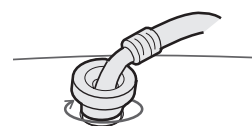

- If the water tap has a screw type faucet, connect the water supply hose to the tap as shown.

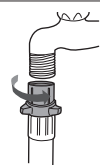

- 
  - After completing connection, if water leaks from the hose, then repeat the same steps. Use the most conventional type of faucet for water supply. In case the faucet is square or too big, remove the spacing ring before inserting the faucet into the adaptor.
  - The appliance is to be connected to the water mains using new hose-sets and that old hose-sets should not be used.

## POSITIONING THE DRAIN HOSE

The end of the drain hose may be positioned in three ways:

### Over the edge of a wash basin

The drain hose must be placed at a height of between 60 and 90 cm. To keep the drain hose spout bent, use the supplied plastic hose guide. Secure the guide to the wall with a hook or to the faucet with a piece of string to prevent the drain hose from moving.



### In a sink drain pipe branch

The drain pipe branch must be above the sink siphon so that the end of the hose is at least 60 cm above the ground.

### In a drain pipe

Samsung recommends that you use a 65 cm high vertical pipe; it must be no longer than 90 cm.

# installing the washing machine

## PLUGGING IN THE MACHINE

### For European Users.

You will NOT need to ground the plug of the washing machine.

### For U.S. Users.

You MUST ground the plug of the washing machine. Check with a licensed electrician before using the machine to make sure it is properly grounded.

### For U.K. Users.

#### Wiring Instructions

##### - WARNING THIS APPLIANCE MUST BE EARTHED.

This appliance must be earthed. In the event of an electrical short circuit, earthing reduces the risk of electric shock providing an escape wire for the electric current.

The appliance is equipped with a mains lead which includes an earth wire for connecting to the earth terminal of your mains plug.

The plug must be plugged into a socket that is properly installed and earthed.

- \* The wires in this mains lead are coloured in accordance with the following code:
  - Green and yellow : Earth
  - Blue : Neutral
  - Brown : Live
- AS the colours of the wires in the mains lead of this appliance may not correspond with the coloured markings indentifying the terminals in your plug, proceed as follows.
- Connect the green and yellow wire to the terminal in the plug marked with the letter E or the earth symbol ( $\perp$ ) or coloured green or green-and-yellow.
- Connect the blue wire to the terminal marked with the letter N or coloured black.
- Connect the brown wire to the terminal marked with the letter L or coloured red.
- \* Consult a qualified electrician or service technician if in doubt about any of these instructions.

The manufacturer of this washing machine will not accept any liability for damage to persons or material for non observance of these requirements.

There are no user serviceable parts inside the washing machine and if the mains lead of this appliance is damaged, it must only be replaced by qualified service personnel approved by the manufacturer because special tools are required.

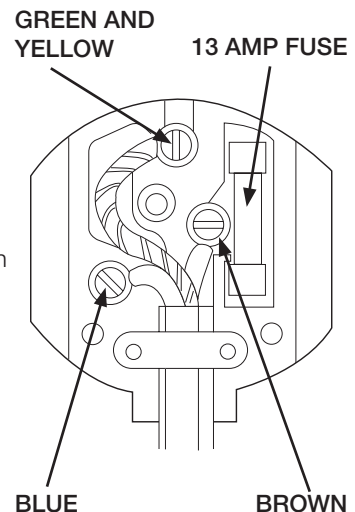

#### WARNING

Ensure that the plug and power cord are not damaged before use. If you have any reason to remove the moulded plug from this appliance, immediately remove the fuse and dispose of the plug. Do not connect the plug to a mains socket under any circumstances as there is a danger of electric shock.

#### CIRCUITS

Your washing machine should be operated on a separate circuit from other appliances. Failure to do this may cause the circuit breaker to trip or the fuse to blow.

# washing a load of laundry

## WASHING FOR THE FIRST TIME

Before washing clothes for the first time, you must run a complete cycle without clothes.

### To do this:

1. Press the **Power** button.
2. Pour a little detergent into compartment (II) in the detergent drawer.
3. Turn on the water supply to the washing machine.
4. Press the **Start/Pause** button.
  - This will remove any water from the manufacturer's test run remaining in the machine.

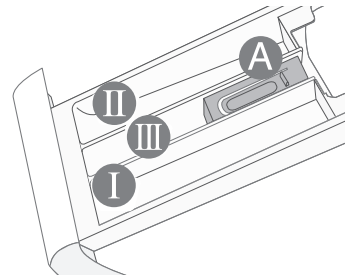

**Dispenser ①:** Detergent for prewash or starch.

**Dispenser ②:** Detergent for main wash, water softener, pre-soaking agent, bleach and stain removal product.

**Dispenser ③:** Additives, e.g. fabric softener or former (fill no higher than lower edge of insert "A")

## PUTTING DETERGENT IN THE WASHING MACHINE

1. Pull out the detergent drawer.
2. Add laundry detergent into compartment (II).
3. Add softener into compartment (III) (if you desire).
4. Add prewash detergent into compartment (I) (if you desire).



Concentrated or thick fabric softener and conditioner must be diluted with a little water before being poured into the dispenser (prevents the overflow from becoming blocked.)

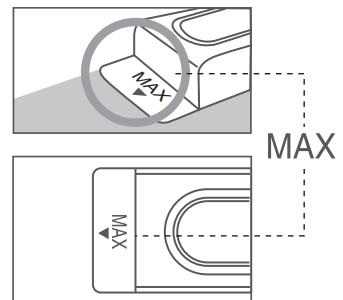

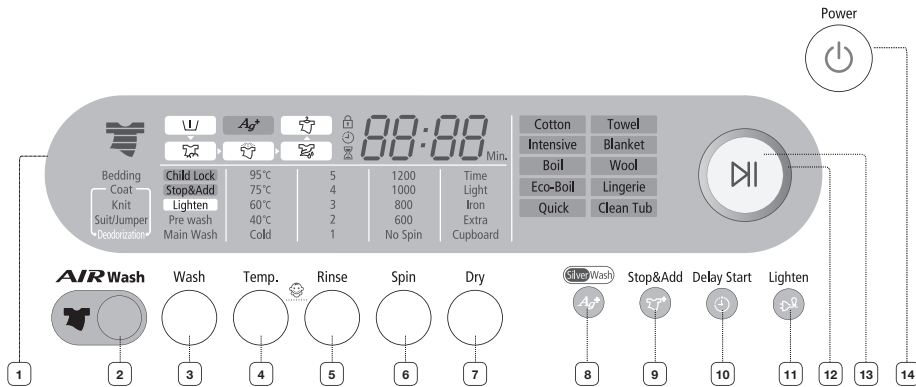

# washing a load of laundry

## OVERVIEW OF THE CONTROL PANEL



1	<b>Display panel</b>	Displays the remaining wash cycle time, all of washing information and error messages.				
2	<b>Air Wash button</b>	Use to remove bad smells. Selected in the sequence: Suit/Jumper → Knit → Coat → Bedding → Cancel				
3	<b>Wash selection button</b>	Use this to only perform washing or prewash. Selected in the sequence: Main Wash → Prewash + Main Wash → Main Wash. The washing time cannot be adjusted (for the Cotton course). Prewash can only be selected for Cotton, Intensive, Boil, Eco-Boil, Blanket and Towel.				
4	<b>Temperature selection button</b>	Selected in the sequence. <table border="1"> <tbody> <tr> <td>220 V</td> <td>40°C → 60°C → Cold → 40°C</td> </tr> <tr> <td>120 V</td> <td>30°C → 40°C → Cold → 30°C</td> </tr> </tbody> </table> <p>The water temperature varies depending on the course. * Do not allow only hot water to be supplied.</p>	220 V	40°C → 60°C → Cold → 40°C	120 V	30°C → 40°C → Cold → 30°C
220 V	40°C → 60°C → Cold → 40°C					
120 V	30°C → 40°C → Cold → 30°C					
5	<b>Rinse selection button</b>	Select this to add a rinse cycle or only perform the rinse cycle. You can select this up to 5 times.				
6	<b>Spin selection button</b>	You can select the spin speed, if necessary. If only the spin cycle is selected and Start/Pause is pressed in the middle of the spin cycle, the machine starts spinning from the beginning. * The spin speed can vary, depending on the course. * No Spin means no spinning is performed after the drain.				
7	<b>Dry selection button</b>	Selected in the sequence: Cupboard → Extra → Iron → Light → Time (30min → 1:00min → 1:30min → 2:00min → 2:30min) → Cupboard.				
8	<b>Silver Wash button</b>	Silver water is supplied in the wash cycle as well as the last rinse, featuring sterilization and antibacterial coating.				
9	<b>Stop&amp;Add selection button</b>	Select this to add the laundry amid the process.				
10	<b>Delay Start selection button</b>	Press the button repeatedly to cycle through the available delayed start options (up to 24 hours maximum in one hour increments). Displayed hours means the time of finished washing-cycle.				

11 <b>Power Saving(Lighten)</b>	The temperature will be reduced by 10 degrees more than initially specified. The reduced temperature does not deteriorate the washing performance greatly, and saves 25% electricity. This feature is available for at least -40°C.
12 <b>Fuzzy Control dial</b>	Turn the dial to select one of the 10 available wash programs.
13  <b>Start/Pause selection button</b>	Press to pause and restart programs.
14  <b>Power selection button</b>	Press once to turn the washing machine on, press again to turn the washing machine off. If the washing machine power is left on for longer than 10 minutes without any buttons being touched, the power automatically turns off.

## FOR THE SILVER WASH WASHING

The Ag+ water is added during the washing, and then a sanitary, sterilizing washing will be performed. During the rinse, the Ag+ water is added at the last time of rinse. It treats clothes with silver antibiotic coating and functions to protect the propagation of bacteria.

1. Open the door, put in the clothes and close the door again.
2. Press **Power** button.
3. Select a course by turning the course selection dial.
4. Press **Silver Wash** button.
5. Put suitable amount of detergent and fibre softener in the detergent tray, and close it again.  
: Put a suitable amount of detergent in the detergent tray for main washing, and put in fiber softener to the lower level than the marked line.  
For Prewash, put a supplementary detergent in the detergent tray.

 Silver Wash: If it is used together with fibre softener, its effect may be decreased.

6. Press **Start/Pause** button.  
: It automatically performs an optimal washing with sensing the weight of clothes.

# washing a load of laundry

---

## CHILDLCK (BUTTON LOCK FUNCTION)

---

Is a function for children not to handle the washing machine.

### Setting/Release

---

If you want to set up or release that function, press both **Temperature** and **Rinse** buttons at the same time in 3sec.

#### How to Set up:

1. It can be set up during the power-on or operation of the washing machine.
2. If you set up the “**CHILDLCK**” function during the laundry operation, no button except for **Power** button can be controlled until you release that function.
3. The CHILDLCK lamp will be lighted.



1. In case the power is on again, the “**CHILDLCK**” function remains unchanged.
2. In case of releasing that function, follow the way of release mentioned above.
3. When the other buttons, except for the **Power** button, are not controlled after you turn on the Power , check CHILDLCK LAMP, please.

## WASHING CLOTHES MANUALLY

---

You can wash clothes manually without using the Fuzzy Logic feature.

#### To do so:

1. Turn the water supply on.
2. Press the **Power** button on the washing machine.
3. Open the door.
4. Load the articles one at a time loosely into the drum, without overfilling.
5. Close the door.
6. Put the detergent and, if necessary, softener or prewash detergent, in the appropriate compartments.
7. Press the Temperature button to select the temperature.

220 V	Cold, 40°C, 60°C, 75°C, 95°C
120 V	Cold, 30°C, 40°C, 55°C, 70°C

8. Press to **Rinse** button to select the required number of rinse cycles.  
Maximum number of rinse cycles is five.  
The washing duration will be prolonged accordingly.
9. Press the **Spin** button to select the spin speed.
10. Press the **Delay Start** button repeatedly to cycle through the available delayed start options (up to 24 hours maximum in one hour increments.). Displayed hours means the time of finished washingcycle.
11. Press the **Start/Pause** button and the machine will begin the cycle.

## WASHING CLOTHES USING FUZZY LOGIC

Your new washing machine makes washing clothes easy, using Samsung's "Fuzzy Logic" automatic control system. When you select a wash program, the machine will set the correct temperature, washing time, and washing speed.

### To wash clothes using the Fuzzy Logic programs:

1. Turn on your sink's water faucet.
  2. Press the **Power** button.
  3. Open the door.
  4. Load the articles one at a time loosely into the drum, without overfilling.
  5. Close the door.
  6. Add the detergent, softener, and prewash detergent (if necessary) into the appropriate compartment.
-  Prewash is only available when washing Towel, Cotton, Boil, Eco-Boil, Intensive, Blanket. It is only necessary if your clothing is heavily soiled.
7. Turn the Fuzzy Control dial to select the appropriate program for the type of clothes Cotton, Intensive, Boil, Eco-Boil, Quick, Towel, Blanket, Wool, lingerie, Clean Tub. You will see the indicators light up on the control panel.

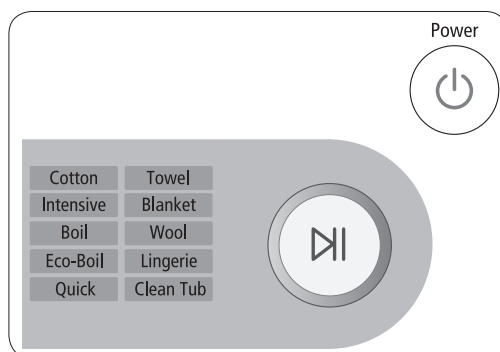

8. At this time, you can control the wash temperature, rinsing times, spin speed, delay time, silver wash and dry button by pressing the appropriate option button. (delay time, silver wash and dry button can be selected optionally by user.)
9. Press the **Start/Pause** button on the Fuzzy Control dial and the wash cycle will begin. The process indicator will light up and the remaining time for the cycle will appear in the display.

### Pause Option

Until water supply is completed after starting operation, it is possible to put in the laundry or take out.

If push **Start/Pause** button, the door is unlocked immediately.

In case of too hot or too much water in washer, the door can not be opened.

After closed the door, one more push **Start/Pause** button to make washing process going on continuously.

### When the cycle is finished:

After the total cycle has finished, the power will turn off automatically.

1. Open the door.  
 The door will not open until the machine stops or the power turns off.
2. Remove laundry.

# washing a load of laundry

---

## USING DRY COURSE

---

Refer to the label of drying capacity and be sure to put in the clothes to the lower level than the marked line for the dried clothe of 7.0kg.

1. Open the door, put in the clothes and close the door again.
2. Press the **Power** button and then press the **Dry** button.  
: The standard course will be selected automatically.  
Drying is available only at the courses such as Towel, Cotton, Boil, Eco-Boil, Intensive and Quick.
3. Select **Dry** button as follows.  
: Every press of this button will select drying type repeatedly in the following order:  
Cupboard → Extra → Iron → Light → Time[30 min → 1:00 min → 1:30 min → 2:00 min → 2:30 min] → Cupboard
  - It automatically displays Drying Time by sensing the weight of clothes before drying for increasing the drying effect.
4. Put suitable amount of detergent and fiber softener in the detergent tray and close it again.
5. Press **Start/Pause** button.  
: It automatically performs an optimal function from washing to drying.
  -  The selected course can't be altered after the start of drying.
  - If you select Drying function, the intensity of SPIN will be set up as High in default for increasing the drying effect.
  - If cold water is not supplied, drying will not be performed.
  - If you do not take out clothes from the tub after the end of drying, a function of wrinkle protection will be performed for about 30 minutes with the display of [End].  
In order to take out the clothes: press firstly **Start/Pause** or **Power** button and take them out.
  - In case you wish to dry after hand washing, select both **Spin** and **Dry** at the same time.

## USING DELAY START

---

You can set the washing machine to finish your wash automatically at a later time, choosing up to 24 hours maximum (in one hour increments). Displayed hours means the time of finished washing-cycle.

### To do this:

1. Manually or automatically set your washing machine for the type of clothes you are washing.
2. Press the **Delay Start** button repeatedly until the delay time is set.
3. Press the **Start/Pause** button. The Delay Start indicator will light, and the clock will begin counting down until it reaches your finish time.
4. To cancel "**Delay Start**", press the **Power** button, then turn the washing machine on again.



## TO ADD LAUNDRY

---

1. Press the **Stop&Add** button.
    - The washing machine will automatically pause to operate.
  2. Wait about 30 seconds and check the **Stop&Add** button for the lamp state.
    - **Blinking:** the machine drains water down to the safety level so it can get an additional quantity of laundry (displayed in pause mode)
    - **Off:** adding the laundry is possible.
-  The washing machine detects the internal quantity of laundry about 30 seconds before deciding whether it could get more laundry.
3. Add the laundry.
  4. Press the **Start/Pause** Button.
    - Avoid adding the laundry when the machine has foamed up or is filled with water. Otherwise, the foam or water may leak out of the door. So check it first before opening the door.

## USING CLEAN TUB

---

Is a course for washing the tub.

1. Press **Power** button.
2. Select the Clean Tub Course by turning the dial of Course Select.
3. Put an adequate amount of bleaching agent in the detergent tray (II) for Main Laundry. (See "Washing for the first time".)  
: You'd better use a powder-type detergent for more efficient washing.  
If you want to wash it lightly : You may wash it just by selecting the 40°C-Water without bleaching agent.
4. Press **Start/Pause** button.

 About one time a month is enough for the tub-washing.



# washing a load of laundry

---

## PERFORMING AIR WASH

---

Air-wash can remove any bad smells from the laundry owing to its powerful airing system. Clothing that can be deodorized includes woolen coats, cotton or down jumpers, sweaters and suits. (Two suits or less)

1. Open the door, place the laundry inside and close the door.
2. Press the **Power** button.
3. Press the **Air Wash** button.
  - Each time the button is pressed, the operating mode cycles through the following sequence:  
Suit/Jumper → Knit → Coat → Bedding → Cancel.
  - When one of these is selected, no other button can be selected or run and you can only select the delay start function from between 1:00 – 24:00.
4. Close the door and press the **Start/Pause** Button.
  -  • If you do not remove the laundry immediately after the Air Wash is performed, the machine performs an additional wrinkle protection process for 30 minutes.
    - Press the **Start/Pause** or **Power** button to remove the laundry.
    - The 'insecticide' process can kill bacteria living in 'unwashable' materials such as blankets, pillows, cushions and needlework dolls.
  -  • Avoid Air Washing the following clothes
    - Sensitive clothes made of leather, mink, fur, silk, etc.
    - Underwear trimmed with lace, 'glued' doll cushions, and dress suits can loosen their decorations.
    - Clothes trimmed with buttons can cause them to break.
    - Starchy clothes can become deformed.
  - Avoid using the following clothes for the insecticide process
    - 1) Hard bedding such as a wooden pillow (neck-rest)
      - Pillows or blankets filled with plastic or starch rather than cotton.
      - Electric blankets
    - 2) Furry blankets
    - 3) Bulky blankets

## WASHING TIPS AND HINTS

**Sorting your laundry:** Sort your laundry according to the following characteristics:

- **Type of fabric care label symbol:** Sort laundry into cottons, mixed fibers, synthetics, silks, wools and rayon.
- **Colour:** Divide whites and colours. Wash new, coloured items separately.
- **Size:** Placing items of different sizes in the same load will improve the washing action.
- **Sensitivity:** Wash delicate items separately, using the Wool wash program for pure new wool, curtains and silk articles. Check the labels on the items you are washing or refer to the fabric care chart in the appendix.

**Emptying pockets:** Coins, safety pins and similar items can damage linen, the washing machine drum, and the water tank.

**Securing fasteners:** Close zippers and fasten buttons or hooks; loose belts or ribbons should be tied together.

**Prewashing cotton:** Your new washing machine, combined with modern detergents, will give perfect washing results, thus saving energy, time, water and detergent. However, if your cotton is particularly dirty, use a prewash with a protein-based detergent.

**Determining load capacity:** Do not overload the washing machine or your laundry may not wash properly. Use the chart below to determine the load capacity for the type of laundry you are washing.

Fabric Type	Load Capacity
Cotton / Intensive	12 kg
Boil / Eco-Boil	7 kg
Towel / Quick / Blanket	1 sheet [Within 3kg]
Wool	5 kg
Dry	7 kg

**Detergent tips:** The type of detergent you should use is based on the type of fabric (otton, synthetic, delicate items, wool) colour, wash temperature, degree and type of soiling.

Always use “low suds” laundry soap, which is designed for automatic washing machines.

Follow the detergent manufacturer’s recommendations based upon the weight of the laundry, the degree of soiling, and the hardness of the water in your area. If you do not know how hard your water is, ask your water authority.

 Keep detergents and additives in a safe, dry place out of the reach of children.

# maintaining the washing machine

---

## DRAINING THE WASHING MACHINE IN AN EMERGENCY

---

1. Unplug the washing machine from the power supply.
2. Open the filter-cover by using a coin or a key.

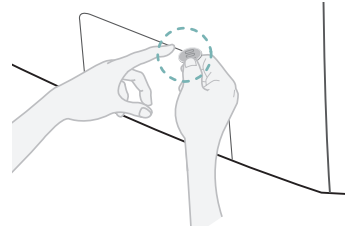

3. Unscrew the emergency drain cap by turning left. Grip the cap on the end of the emergency drain tube and slowly pull it out about 15 cm.
4. Allow all the water to flow into a bowl.
5. Reinsert the drain tube and screw the cap back on.
6. Replace the filter-cover.



## REPAIRING A FROZEN WASHING MACHINE

---

If the temperature drops below freezing and your washing machine is frozen:

1. Unplug the washing machine.
2. Pour warm water on the source faucet to loosen the water supply hose.
3. Remove the water supply hose and soak it in warm water.
4. Pour warm water into the washing machine drum and let it sit for 10 minutes.
5. Reconnect the water supply hose to the water faucet and check if the water supply and drain operations are normal.

## CLEANING THE EXTERIOR

---

1. Wipe the washing machine surfaces, including the control panel, with a soft cloth and nonabrasive household detergents.
2. Use a soft cloth to dry the surfaces.
3. Do not pour water on the washing machine.

## CLEANING THE DETERGENT DRAWER AND RECESS

1. Press the release button inside the detergent drawer and pull it out.
2. Clean the drawer recess and wipe off hardened detergent, fiber softener and water inside.
3. Remove any detergent residue inside.
4. Push the drawer back into place.



- Do not use the water hose to spray water inside, as this may cause electric shock or fire.
- Remove any coins or buttons, as these may obstruct the drain hose.

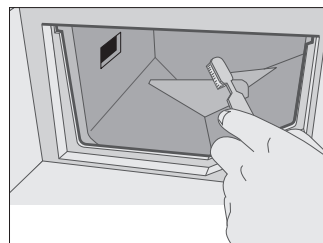
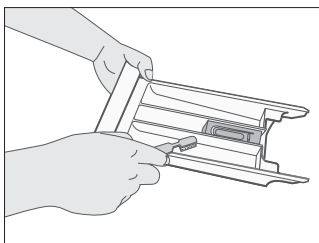
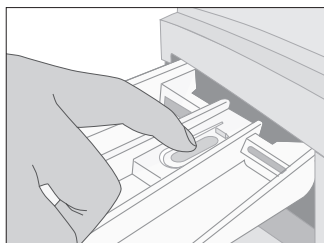

## CLEANING THE DEBRIS FILTER

Clean the debris filter 5 or 6 times a year, or when you see the following error message on the display:

5E

1. Open the filter-cover, see “Draining the washing machine in an emergency”.
2. Unscrew emergency drain cap by turning left and drain off all the water.  
See “Draining the washing machine in an emergency”.
3. Unscrew the filter cap and take it out.

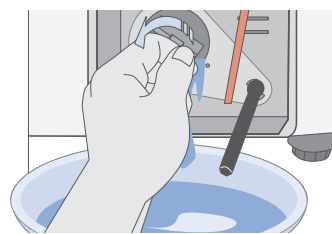

4. Wash any dirt or other material from the filter. Make sure the drain pump propeller behind the filter is not blocked.  
Replace the filter cap.
5. Replace the filter-cover.

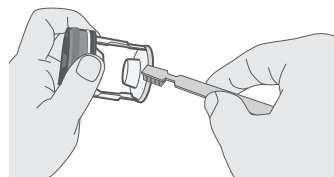

# maintaining the washing machine

## CLEANING THE WATER HOSE MESH FILTER

You should clean the water hose mesh filter at least one time per year, or when you see the following error message on the display:

4E

**To do this:**

1. Turn off the water source to the washing machine.
2. Unscrew the hose from the back of the washing machine.
3. With a pair of pliers, gently pull out the mesh filter from the end of the hose and rinse it under water until clean. Also clean the inside and outside of the threaded connector.
4. Push the filter back into place.
5. Screw the hose back onto the washing machine.
6. Turn on the faucet and make sure the connections are watertight.

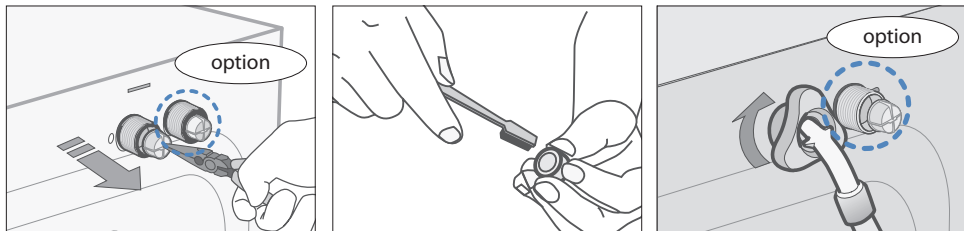

# troubleshooting

## PROBLEMS AND SOLUTIONS

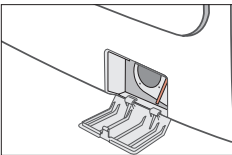
PROBLEM	SOLUTION
The washing machine will not start	<ul style="list-style-type: none"> <li>• Make sure the door is firmly closed.</li> <li>• Make sure the washing machine is plugged in.</li> <li>• Make sure the water source faucet is turned on.</li> <li>• Make sure to press the Start/Pause button.</li> </ul>
No water or insufficient water supply	<ul style="list-style-type: none"> <li>• Make sure the water source faucet is turned on.</li> <li>• Make sure the water source hose is not frozen.</li> <li>• Make sure the water intake hose is not bent.</li> <li>• Make sure the filter on the water intake hose is not clogged.</li> </ul>
Detergent remains in the detergent drawer after the wash program is complete	<ul style="list-style-type: none"> <li>• Make sure the washing machine is running with sufficient water pressure.</li> <li>• Put the detergents in the inner parts of the detergent drawer(away from the outside edges).</li> </ul>
Washing machine vibrates or is too noisy	<ul style="list-style-type: none"> <li>• Make sure the washing machine is set on a level surface. If the surface is not level, adjust the washing machine feet to level the appliance.</li> <li>• Make sure that the shipping bolts are removed.</li> <li>• Make sure the washing machine is not touching any other object.</li> <li>• Make sure the laundry load is balanced.</li> </ul>
The washing machine does not drain and/or spin	<ul style="list-style-type: none"> <li>• Make sure the drain hose is not squashed or bent.</li> <li>• Make sure the water hose mesh filter is not clogged.</li> </ul>
The Door does not open	<ol style="list-style-type: none"> <li>1. Disconnect the power plug from the power supply.</li> <li>2. Remove the water from the washing machine.</li> <li>3. Open the filter cover using a coin.</li> <li>4. Locate the orange plastic tab and pull forward to open the door.</li> </ol> 

# troubleshooting

---

## UNDERSTANDING ERROR MESSAGES

---

ERROR CODE	SOLUTION
dE	<ul style="list-style-type: none"><li>• Close the door.</li></ul>
4E	<ul style="list-style-type: none"><li>• Make sure the source water faucet is turned on.</li><li>• Check the water pressure.</li></ul>
5E	<ul style="list-style-type: none"><li>• Check if the water in the drain hose is frozen.</li><li>• Press the <b>Start/Pause</b> button to resume operating.</li></ul>
UE	<ul style="list-style-type: none"><li>• Laundry load is unbalanced; loosen any tangled laundry. If only one item of clothing needs washing, such as a bathrobe or jeans, the final spin result might be unsatisfactory and an “UE” error message will be shown in the display window.</li></ul>
Hot	<ul style="list-style-type: none"><li>• It appears when the internal temperature of the drum is high. The fan will automatically function, so just wait until “Hot” indication disappeared.</li></ul>
cE	<ul style="list-style-type: none"><li>• This is when the internal temperature does not go down below a certain degree in washing or hydrating. Press the <b>Start/Pause</b> button to try again.</li></ul>
3E	<ul style="list-style-type: none"><li>• Call after-sales service.</li></ul>

### Before contacting After-Sales service:

1. Try to remedy the problem (See “Troubleshooting” on this page).
2. Restart the programme to see if the fault is repeated.
3. If the malfunction persists, call after-sales service and describe the problem.



# programme chart

## PROGRAMME CHART

(● user option)

























Program	Max load (kg)	Detergent and additives			Temperature (MAX) °C				Spin rpm (max)	Delay start	Water (l)	Electricity (kWh)	
		Pre-wash	Wash	Soft-ener	220 V		120V					220 V	120 V
					Default	Max	Default	Max					
Cotton	12	●	yes	●	40	60	30	40	800(1200)	●	110	0.77	0.57
Intensive	12	●	yes	●	40	60	30	40	800(1200)	●	110	0.77	1.00
Boil	7	●	yes	●	95	95	70	70	800(1200)	●	98	2.80	1.74
Eco-Boil	7		yes	●	75	75	55	55	800(1200)	●	98	2.15	1.39
Quick	3		yes	●	40	40	30	30	800(1200)	●	72	0.66	0.45
Towel	3	●	yes	●	40	95	30	70	600(800)	●	130	0.85	0.60
Blanket	1sheet (Within 3kg)	●	yes	●	Cold	40	Cold	30	800	●	108	0.15	0.59
Wool	5		yes	●	Cold	40	Cold	30	600	●	80	0.05	0.05
Lingerie	3		yes	●	Cold	40	Cold	30	600	●	75	0.07	0.07
Clean Tub			yes		40	40	30	30	600		66	1.25	0.72

Program	Type of wash
Cotton	Average or lightly soiled cottons, bed linen, table linen, underwear, towels, shirts, etc.
Intensive	This course is appropriate to wash underwear we change everyday, strong dirt removal and sterilization is performed simultaneously.
Boil	This course is appropriate to wash underwear we change everyday, strong dirt removal and sterilization is performed simultaneously.
Eco-Boil	Delicate curtains, dresses, skirts, shirts and blouses.
Quick	Lightly soiled cottons or linen blouses, shirts, dark coloured terry cloth, coloured linen articles, jeans, etc.
Towel	This course is appropriate to wash towels effectively.
Blanket	Cotton bedding, bed linen, bed sheet, duvet cover, pillow cover etc.
Wool	Only wash machine washable woolens with pure new wool label.
Lingerie	For sensitive laundry that is easily damaged.
Clean Tub	Use this function to maintain wash tub clean and sanitary.

1. Programme with prewash lasts approx. 15 minutes longer.
2. The programme duration data has been measured under the conditions specified in Standard IEC 69456.
3. Consumption in individual homes may differ from the values given in the table due to variations in the pressure and temperature of the water supply, the load and the type of laundry.

# appendix

## FABRIC CARE CHART

	Resistant material		Can be ironed at 100°C max
	Delicate fabric		Do not iron
	Item may be washed at 95°C		Can be dry cleaned using any solvent
	Item may be washed at 60°C		Dry clean with perchloride, lighter fuel, pure alcohol or R113 only
	Item may be washed at 40°C		Dry clean with aviation fuel, pure alcohol or R113 only
	Item may be washed at 30°C		Do not dry clean
	Item may be hand washed		Dry flat
	Dry clean only		Can be hung to dry
	Can be bleached in cold water		Dry on clothes hanger
	Do not bleach		Tumble dry, normal heat
	Can be ironed at 200°C max		Tumble dry, reduced heat
	Can be ironed at 150°C max		Do not tumble dry

## ELECTRICAL WARNINGS

To reduce the risk of fire, electrical shock, and other injuries, keep these safety precautions in mind:

- Operate the appliance only from the type of power source indicated on the marking label. If you are not sure of the type of power supplied to your home, consult your appliance dealer or local power company.
- Use only a grounded or polarized outlet. For your safety, this appliance is equipped with a polarized alternating current line plug having one blade wider than the other. This plug will fit into the power outlet only one way. If you are unable to insert the plug fully into the outlet, try reversing the plug. If the plug still doesn't fit, contact your electrician to replace your outlet.
- Protect the power cord. Power supply cords should be routed so that they are unlikely to be walked on or pinched by items placed on or against them. Pay particular attention to cords at plugs, convenience receptacles, and the point where they exit from the unit.
- Do not overload the wall outlet or extension cords. Overloading can result in fire or electric shock.

## PROTECTING THE ENVIRONMENT

- This appliance is manufactured from recyclable materials. If you decide to dispose of this appliance, please observe local waste disposal regulations. Cut off the power cord so that the appliance cannot be connected to a power source. Remove the door so that animals and small children cannot get trapped inside the appliance.
- Do not exceed the detergent quantities recommended in the detergent manufacturers' instructions.
- Use stain removal products and bleaches before the wash cycle only when strictly necessary.
- Save water and electricity by only washing full loads (the exact amount depends upon the program used).

## DECLARATION OF CONFORMITY

This appliance complies with European safety standards, EC directive 93/68 and EN Standard 60335.

## SPECIFICATION

TYPE	FRONT LOADING WASHER		
DIMENSION	W 650 mm X D 765 mm X H 940 mm		
WATER PRESSURE	50 ~ 780 kPa		
WEIGHT	96 kg		
WASH and SPIN CAPACITY	12.0 kg [DRY LAUNDRY]		
DRY CAPACITY	7.0 kg		
POWER CONSUMPTION	WASHING	220 V	150 W
		120 V	137 W
	WASHING AND HEATING	220 V	2100 W
		120 V	1020 W
	DRYING	220 V	1900 W
		120 V	1350 W
WATER VOLUME	110 ℓ		
SPIN REVOLUTION	MODEL	WD6122CKC/WD6122CKS	
	rpm	1200 rpm	

The appearance and specifications of the product are subject to change without prior notice for purposes of enhancement.



QUESTIONS OR COMMENTS?

Country	CALL	OR VISIT US ONLINE AT
THAILAND	1800-29-3232 02-689-3232	<a href="http://www.samsung.com/th">www.samsung.com/th</a>