

# Washing Machine Owner's Instructions

**C1235/  
C1035/  
C835**



<b>Safety Precautions</b> .....	<b>2</b>
<b>Installing the Washing Machine</b> .....	<b>3</b>
Unpacking the washing machine .....	3
Overview of the washing machine .....	3
Selecting a location .....	3
Adjusting the leveling feet .....	3
Removing the shipping bolts .....	4
Connecting the water supply hose .....	4
Positioning the drain hose .....	4
<b>Washing a Load of Laundry</b> .....	<b>5</b>
Overview of the control panel .....	5
Washing for the first time .....	7
Putting detergent in the washing machine .....	7
Washing clothes manually .....	8
Using delay start .....	8
Selecting options .....	8
Washing tips and hints .....	9
<b>Maintaining the Washing Machine</b> .....	<b>10</b>
Repairing a frozen washing machine .....	10
Cleaning the exterior .....	10
Cleaning the debris filter .....	10
Cleaning the water hose mesh filter .....	10
<b>Troubleshooting</b> .....	<b>11</b>
Problems and solutions .....	11
Understanding error messages .....	11
<b>Programme chart</b> .....	<b>12</b>
<b>Appendix</b> .....	<b>13</b>
Fabric care chart .....	13
Electrical warnings .....	13
Protecting the environment .....	13
Declaration of conformity .....	13
Specification .....	14

---

---

## Safety Precautions

---

---

Congratulations on your purchase of this Samsung washing machine. These Owner's Instructions contain valuable information on the installation, use, and care of this appliance. Please take the time to read these instructions so that you can take full advantage of the washing machine's features and enjoy this appliance for many years to come.

### Before using the appliance

- Packing materials can be dangerous to children; keep all packing material (plastic bags, polystyrene, etc.) well out of the reach of children.
- The appliance is designed for home use only.
- Make sure that water and electrical connections are made by qualified technicians, observing the manufacturer's instructions (see "Installing the Washing Machine" on page 3) and local safety regulations.
- All packaging and shipping bolts must be removed before the appliance is used. Serious damage may occur if they are not removed. See "Removing the shipping bolts" on page 4.
- Before washing clothes for the first time, you must run a complete cycle without clothes. See "Washing for the first time" on page 8.
- This product is designed for low water consumption and effective washing performance. The water level during wash and rinse cycles will not be visible in the front viewing windows. This is normal and does not indicate malfunction.
- Please dispose of the package for this product in an environmentally friendly manner.

### Safety instructions

- Before cleaning or carrying out maintenance, unplug the appliance from the electrical outlet or set the ① (On/Off) button to Off.
- Make sure that the pockets of all clothing to be washed are empty. Hard, sharp objects, such as coins, safety pins, nails, screws, or stones can cause extensive damage to the appliance.
- Always unplug the appliance and turn off the water after use.
- Before you open the door of the appliance, check that the water has drained. Do not open the door if you can still see water.
- Pets and small children may climb into the appliance. Check the appliance before each use.
- The glass door becomes very hot during the washing cycle. Keep children away from the appliance while it is in use.
- Do not attempt to repair the appliance yourself. Repairs made by inexperienced or unqualified persons may cause injury and/or make more serious repairs to the appliance necessary.
- If the plug (power supply cord) is damaged, it must be replaced by the manufacturer or its service agent or a similar qualified person in order to avoid a hazard.
- This appliance should only be serviced by an authorized service center, and only genuine spare parts should be used.
- This appliance is not intended for use by young children or infirm persons unless they have been adequately supervised by a responsible person to ensure that they can use the appliance safely. Young children should be supervised to ensure that they do not play with the appliance.
- If this appliance is supplied from a cord extension set or an electrical portable outlet device, the cord extension set or electrical portable outlet device must be positioned so that it is not subject to splashing or ingress of moisture. Additionally, the cord extension set or electrical portable outlet device must be of a current rating suitable for the appliance.

**SAVE THESE INSTRUCTIONS**

---

---

# Installing the Washing Machine

---

---

## Unpacking the Washing Machine

Unpack your washing machine and inspect it for shipping damage. Also make sure that you have received all of the items shown below. If the washing machine was damaged during shipping or you do not have all of the items, contact your Samsung dealer immediately.

## Overview of the washing machine

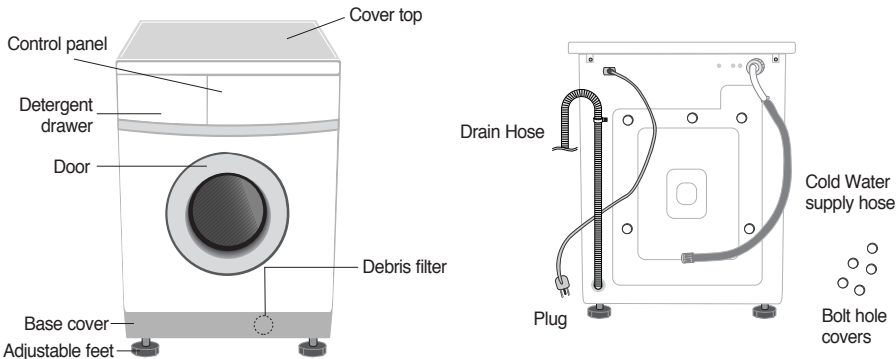

## Selecting a location

Before you install the washing machine, select a location with the following characteristics:

- A hard, level surface (if the surface is uneven, see "Adjusting the leveling feet," below)
- Away from direct sunlight.
- Adequate ventilation
- Room temperature that will not fall below 0 °C
- Away from sources of heat such as coal or gas

Make sure that the washing machine does not stand on its power cord.

Ventilation openings must not be obstructed by carpeting when the washing machine is installed on a carpeted floor.

## Adjusting the leveling feet

If the floor is uneven, adjust the feet (do not insert pieces of wood or any other objects under the feet):

1. Loosen the leg bolt by turning it with your hand until it is at the desired height.
  2. Tighten the locking nut by turning it with the wrench.
- **Place the washer on a sturdy, flat surface.**  
If the washer is placed on an uneven or weak surface, noise or vibration occurs. (Only a 1 degrees angle is allowed.)

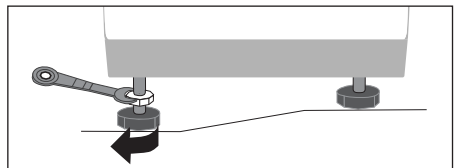

---

---

# Installing the Washing Machine

---

---

## Removing the shipping bolts

Before using the washing machine, you must remove all of the shipping bolts from the back of the unit. To remove the bolts:

1. Loosen all bolts with the wrench before removing them.
2. Take each bolt head and pull it through the wide part of the hole. Repeat for each bolt.
3. Fill the holes with the supplied plastic covers.
4. Keep the shipping bolts for future use.

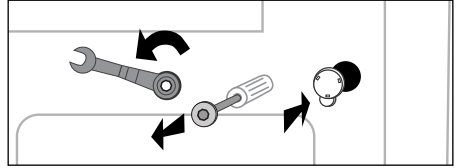

## Connecting the water supply hose

The water supply hose must be connected to the washing machine at one end and to the water faucet at the other. Do not stretch the water supply hose. If the hose is too short and you do not wish to move the water faucet, replace the hose with a longer, high pressure hose.

### To connect the water supply hose:

1. Take the L-shaped arm fitting for the cold water supply hose and connect to the cold water supply intake on the back of the machine. Tighten by hand.
2. Connect the other end of the cold water supply hose to your sink's cold water faucet and tighten it by hand. If necessary, you can reposition the water supply hose at the washing machine end by loosening the fitting, rotating the hose, and retightening the fitting.

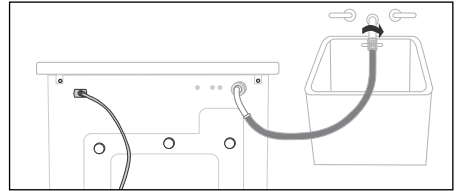

## Positioning the drain hose

The end of the drain hose may be positioned in three ways:

### Over the edge of a sink

The drain hose must be placed at a height of between 60 and 90 cm. To keep the drain hose spout bent, use the supplied plastic hose guide. Secure the guide to the wall with a hook or to the faucet with a piece of string to prevent the drain hose from moving.

### In a sink drain pipe branch

The drain pipe branch must be above the sink siphon so that the end of the hose is at least 60 cm above the ground.

### In a drain pipe

Samsung recommends that you use a 65 cm high vertical pipe; it must be no shorter than 60 cm and no longer than 90 cm.

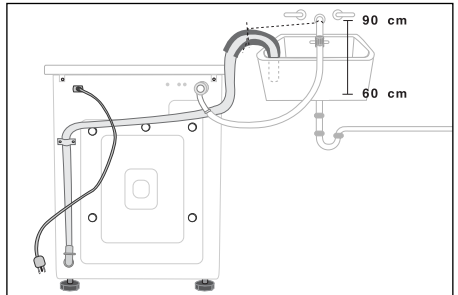

# Washing a Load of Laundry

## Overview of the control panel

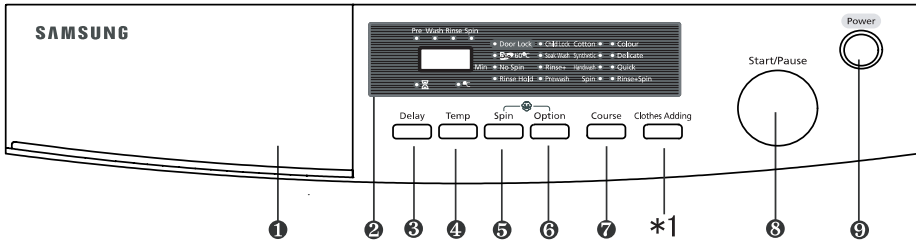

### 1. Detergent dispenser

### 2. Display panel

Displays wash cycle and error messages by LED lamps.

During execution of the program, the program indicator blinks.

### 3. Delay Start button

Press the button repeatedly to cycle through the available delayed start options. (from 1 hour to 19 hours in one hour increments).

### 4. Temperature selection button

Press the button repeatedly to cycle through the available water temperature options. (cold water, 30°C, 40°C, 60°C and 95°C).

When pressing this button during washing, you can see the selected temperature in the display panel.

### 5. Spin selection button

Press the button repeatedly to cycle through the available spin speed options.

C1235	no, rh, 400, 600, 800, 1000, 1200 rpm	no:no spin, rh:rinse hold
C1035	no, rh, 400, 600, 800, 1000 rpm	
C835	no, rh, 400, 600, 800 rpm	

When pressing this button during operation, you can see the selected spin speed in the display panel.

### 6. Option button

Press the button repeatedly to cycle through the available partial wash options

Soak wash → Prewash → Rinse\* → (Soak wash + Rinse\*) → (Rinse\* + Prewash) → Cancel

Note : Prewash is only available when washing cotton, synthetic or delicate.

### 7. Course button

Press the button to select one of the eight available wash programs.

Cotton, Colour, Synthetic, Delicate, Handwash, Quick, Spin, Rinse+Spin

### 8. Start/Pause button

Press to pause and restart programs.

### 9. Ⓞ (On/Off) button

Press once to turn the washing machine on, press again to turn the washing machine off.

If the washing machine power is left on for longer than 10 minutes without any buttons being touched, the power automatically turns off.

\*1 Clothes adding, the programme will be paused and you can add cloth within 5 minutes after running the washing machine.

\*2 Bio 60°C the water is heated to 40°C firstly, after soaking for 30 minutes then heated to 60°C and start the wash programme, the chemical character or biology enzyme is the most active in the 40°C water, soak the clothes for 30 minutes, then heat to 60°C and start washing according to this course, the clothes will be completely clean, this function is only limited to the cotton and colour programme.

### ● What is the “Child Lock” function?

- If you press the “Child Lock” button(Spin+Option button) longer than 2 sec during operation, this function is selected.
- If once this function is selected, no change can be done until the end of laundry.
- Press the “Child Lock” button(Spin+Option button) longer than 2 sec to cancel the function.

\*Note: 1. Restart the washing machine, “Child Lock”function is still available.

2. Please check the “Child Lock”function if you could not set any function button, expect power button when you start the washing machine.

● When the power cutted washing procedure has spenal, automatic protection fuctions and the door could not open until regiving the power again, but if you want to take out clothes you can:

1. Put the cover front(L).
2. Put the lever.
3. Drag the lever until hear chick sound.
4. Open the door and take out the clothes.

---

---

## Washing a Load of Laundry

---



---

### **WM stops the current step of the cycle or does not proceed to the next step of washing (indication of remain time on LED display may increase).**

Your new washing machine is equipped with Fuzzy Logic system, which not only sets the optimum level of water and other parameters of washing, but also controls the washing process as well as makes necessary corrections in order to provide better washing results. In the above- mentioned matter, the Fuzzy Logic system has detected deviations in washing cycle such as: high quantity of detergent at the end of the cycle, high vibration level while spinning, etc. You can adjust existing wash programs, i.e. change wash temperature and spin speed. After detection of such abnormalities, the washing machine is suspending the normal course of program in order to normalize these parameters and continue the cycle. Fuzzy Logic system makes 7 attempts to eliminate such deviations. If it is impossible to normalize the above mentioned deviations by Fuzzy Logic system, you will see the corresponding indication on LED lamps. (see chapter "Troubleshooting") The operation of Washing machine that corresponds to above- mentioned scheme is considered to be normal.



### **Washing for the first time**

Before washing clothes for the first time, you must run a complete cycle without clothes. To do this:

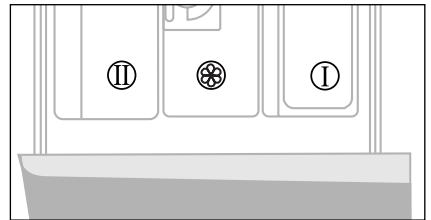
1. Press the  (On/Off) button.
  2. Pour a little detergent in the detergent drawer .
  3. Turn on the water supply to the washing machine.
  4. Press the Temperature button repeatedly until 40°C is displayed.
  5. Press the Start/Pause button.
- This will remove any water from the manufacturer's test run remaining in the machine.



### **Putting detergent in the washing machine:**

1. Pull out the detergent drawer.
2. Add laundry detergent into compartment .
3. Add softener into compartment  (if you desire).

Caution: 1) Concentrated or thick fabric softener and conditioner must be diluted with a little water before being poured into the dispenser. (prevents the overflow from becoming locked)

2) You must forbid putting detergent to the compartment  because detergent may block up.

4. Add prewash detergent into compartment  (if you desire).

---

---



# Washing a Load of Laundry

---

---

## Washing clothes manually

You can wash clothes manually without using the Fuzzy Logic feature. To do so:

1. Turn on the water at the water source sink.
2. Press the  (On/Off) button on the washing machine.
3. Open the door.
4. Load the articles one at a time loosely into the drum, without overfilling.
5. Close the door.
6. Put the detergent in the detergent drawer .
7. Repeatedly press the Program button to select the cycle you prefer:  
(Cotton, Colour, Synthetics, Delicates, and Hand wash, Quick...)
8. Press the Temperature button to select the temperature (cold water 30°C, 40°C, 60°C, 95°C).
9. Press the Spin button to select the spin speed,  
C1235:No spin, No drain, Spin(400, 600, 800, 1000, 1200) No:no spin; rh:no drain  
C1035:No spin, No drain, Spin(400, 600, 800, 1000)  
C835:No spin, No drain, Spin(400, 600, 800)
10. Press the Start/Pause button and the machine will begin the cycle.

### When the cycle is finished:

1. Open the door.  
**Note:** The door will not open until 3 minutes after the machine stops or the power turns off.
2. Remove laundry.

## Using Delay Start

You can set the washing machine to finish your wash automatically at a later time, choosing from 1 to 19 hour delay (in 1 hour increments).

To do this:

1. Manually or automatically set your washing machine for the type of clothes you are washing.
2. Press the Delay Start button repeatedly until the delay time is set.
3. Press the Start/Pause button. The Delay Start indicator will light, and the clock will begin counting down until it reaches your finish time.
4. To cancel Delay Start, press the (On/Off) button, then turn the washing machine on again.

## Selecting options

### Prewash

Prewash is only available when washing cotton, colour, synthetics, delicate clothes. To use prewash:

1. Load the prewash detergent into compartment  of the detergent drawer.
2. Select "Cotton" with the Program select button.
3. Press the Option button until the "Prewash" indicator lights up on the control panel.
4. Press Start/Pause to begin the cycle.

### Rinse\*

Your machine will run through an additional rinsing cycle.

The washing duration will be prolonged accordingly.

### Sock Wash

Select this option for heavily soiled laundry. The machine soaks the laundry for 40 minutes (the drum rotates occasionally). This function cannot be used with the Handwash and Quick program.



---

---

# Washing a Load of Laundry

---

---

## Washing tips and hints

**Sorting your laundry:** Sort your laundry according to the following characteristics:

- **Type of fabric care label symbol:** Sort laundry into cottons, mixed fibers, synthetics, silks, wools and rayon.
- **Colour:** Divide whites and colours. Wash new, coloured items separately. While washing please separate the whites and colours.
- **Size:** Placing items of different sizes in the same load will improve the washing action.
- **Sensitivity:** Wash delicate items separately, using the Delicate wash program for pure new wool, curtains and silk articles. Check the labels on the items you are washing or refer to the fabric care chart in the appendix.

**Emptying pockets:** Coins, safety pins and similar items can damage linen, the washing machine drum, and the water tank.

**Securing fasteners:** Close zippers and fasten buttons or hooks; loose belts or ribbons should be tied together.

**Determining load capacity:** Do not overload the washing machine or your laundry may not wash properly. Use the chart below to determine the load capacity for the type of laundry you are washing.

Fabric Type	Load Capacity
Colour/cotton	
-average/lightly soiled	5.0 kg
-heavily soiled	5.0 kg
Synthetic	3.0 kg
Delicate	2.0 kg
Handwash	1.5 kg

**Detergent tips:** The type of detergent you should use is based on the type of fabric (Cotton, Synthetic, Delicate items) colour, wash temperature, degree and type of soiling. Always use "low suds" laundry soap, which is designed for automatic washing machines.

When determining the detergent quantity, it's necessary to consider recommendations of the detergent manufacturer, indicated on the package, as well as weight, type of laundry, it's fouling factor and water hardness in your region.

**Note:**

Keep detergents and additives in a safe, dry place out of the reach of children.

---

---

# Maintaining the Washing Machine

---

---

## Repairing a frozen washing machine

If the temperature drops below freezing and your washing machine is frozen:

1. Unplug the washing machine.
2. Pour warm water on the source faucet to loosen the water supply hose.
3. Remove the water supply hose and soak it in warm water.
4. Pour warm water into the washing machine drum and let it sit for 10 minutes.
5. Reconnect the water supply hose to the water faucet and check if the water supply and drain operations are normal.

## Cleaning the exterior

1. Wipe the washing machine surfaces, including the control panel, with a soft cloth and non-abrasive household detergents.
2. Use a soft cloth to dry the surfaces.
3. Do not pour water on the washing machine.

## Cleaning the debris filter

Clean the debris filter 2 or 3 times a year.

1. Remove the base cover from the front of the washing machine.
2. Unscrew the filter cap and take it out.
3. Wash any dirt or other material from the filter. Make sure the drain pump propeller behind the filter is not blocked. Replace the filter cap.
4. Replace the base cover.

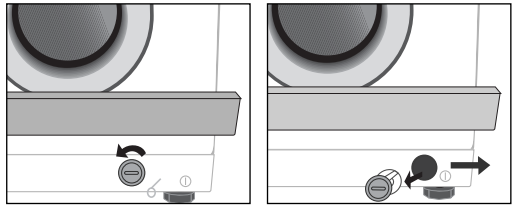

## Cleaning the water hose mesh filter

You should clean the water hose mesh filter at least one time per year,, or when the lamps on your machine flickers:

### To do this:

1. Turn off the water source to the washing machine.
2. Unscrew the hose from the back of the washing machine.
3. With a pair of pliers, gently pull out the mesh filter from the end of the hose and rinse it under water until clean. Also clean the inside and outside of the threaded connector.
4. Push the filter back into place.
5. Screw the hose back onto the washing machine.
6. Turn on the faucet and make sure the connections are watertight.

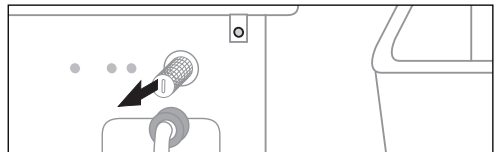

---

---

# Troubleshooting

---

---

## Problems and solutions

### The washing machine will not start

- Make sure the door is firmly closed.
- Make sure the washing machine is plugged in.
- Make sure the water source faucet is turned on.
- Make sure to press the Start/Pause button.

### No water or insufficient water supply

- Make sure the water source faucet is turned on.
- Make sure the water source hose is not frozen.
- Make sure the water intake hose is not bent.
- Make sure the filter on the water intake hose is not clogged.

### Detergent remains in the detergent drawer after the wash program is complete

- Make sure the washing machine is running with sufficient water pressure.
- Put the detergents in the inner parts of the detergent drawer (away from the outside edges).





### Washing machine vibrates or is too noisy

- Make sure the washing machine is set on a level surface. If the surface is not level, adjust the washing machine feet to level the appliance (see page 3).
- Make sure that the shipping bolts are removed (see page 4).
- Make sure the washing machine is not touching any other object.
- Make sure the laundry load is balanced.

### The washing machine does not drain and/or spin

- Make sure the drain hose is not squashed or bent.
- Make sure the water hose mesh filter is not clogged (see page 8).

## Understanding error messages

Error displayed	Solution
	<ul style="list-style-type: none"><li>• Close the door.</li></ul>
	<ul style="list-style-type: none"><li>• Make sure the source water faucet is turned on.</li><li>• Check the water pressure.</li></ul>
	<ul style="list-style-type: none"><li>• Clean the debris filter.</li><li>• Make sure the drainage hose is installed correctly.</li></ul>
	<ul style="list-style-type: none"><li>• Laundry load is unbalanced; loosen any tangled laundry.</li><li>• If only one item of clothing needs washing, such as a bathrobe or jeans, the final spin result might be unsatisfactory and an "E4" error message will be shown in the display window.</li></ul>
	<ul style="list-style-type: none"><li>• Check the end of the drain hose is too low. (Make sure the holder of drain hose in the back is intact)</li><li>• Check the end of the drain hose is submerged in water.</li></ul>

### Before contacting After-Sales service:

1. Try to remedy the problem (See "Troubleshooting" on this page).
2. Restart the programme to see if the fault is repeated.
3. If the malfunction persists, call after-sales service and describe the problem.

## Programme Chart

PRO-GRAM	Max load (kg)	DETERGENT AND ADDITIVES			Temperature (MAX) °C	Spin Speed(MAX)rpm			Delay start	Function	Water (l)	Electricity (kWh)
		Pre wash	wash	Sof tener		C1235	C1035	C835		Pre wash		
Cotton	5.0	*	yes	*	95	1200	1000	800	*	*	60	1.82
Colour	5.0	*	yes	*	95	1200	1000	800	*	*	60	0.95
Synthetic	3.0	*	yes	*	60	800	800	800	*	*	50	0.72
Delicate	2.0	*	yes	*	40	600	600	600	*	*	53	0.49
Handwash	1.5	-	yes	*	40	400	400	400	*	-	59	0.52
Quick	3.0	-	yes	*	40	1000	1000	800	*	-	38	0.57

PROGRAM	Type of WASH
Cotton	Averagely or lightly soiled cottons, bed linen, table linen, underwear, towels, shirts, etc.
Colour	Average or lightly soiled cottons, bed linen, table linen, underwear, towels, shirts, etc.
Synthetic	Lighly or averagely soiled blouses, shirts, etc. Made of polyester(Diolen, Trevira), polyamide(perlon, Nylon) or similar blends.
Delicate	Delicate curtains, dresses, skirts, shirts and blouses.
Handwash	Only machine washable wollens with pure new wool label.
Quick	Lightly soiled cottons or linen blouses, shirts, dark coloured terry cloth, coloured linen articles, jeans, etc.

1. The programme duration data has been measured under the conditions specified in Standard IEC 456.
2. Consumption in individual homes may differ from the values given in the table due to variations in the pressure and temperature of the water supply, the load and the type of laundry.

---





























---

# Appendix

---

---

## Fabric care chart

	Resistant material		Can be ironed at 100°C max	
	Delicate fabric		Do not iron	
		Item may be washed at 95°C		Can be dry cleaned using any solvent
		Item may be washed at 60°C		Dry clean with perchloride, lighter fuel, pure alcohol or R113 only
		Item may be washed at 40°C.		Dry clean with aviation fuel, pure alcohol or R113 only
		Item may be washed at 30°C.		Do not dry clean
	Item may be hand washed		Dry flat	
	Dry clean only		Can be hung to dry	
	Can be bleached in cold water		Dry on clothes hanger	
	Do not bleach		Tumble dry, normal heat	
	Can be ironed at 200°C max		Tumble dry, reduced heat	
	Can be ironed at 150°C max		Do not tumble dry	

## Electrical warnings

To reduce the risk of fire, electrical shock, and other injuries, keep these safety precautions in mind:

- Operate the appliance only from the type of power source indicated on the marking label. If you are not sure of the type of power supplied to your home, consult your appliance dealer or local power company.
- Use only a grounded or polarized outlet. This plug will fit into the power outlet only one way. If you are unable to insert the plug fully into the outlet, try reversing the plug. If the plug still doesn't fit, contact your electrician to replace your outlet.
- Protect the power cord. Power supply cords should be routed so that they are unlikely to be walked on or pinched by items placed on or against them. Pay particular attention to cords at plugs, convenience receptacles, and the point where they exit from the unit.
- Do not overload the wall outlet or extension cords. Overloading can result in fire or electric shock.

## Protecting the environment

- This appliance is manufactured from recyclable materials. If you decide to dispose of this appliance, please observe local waste disposal regulations. Cut off the power cord so that the appliance cannot be connected to a power source. Remove the door so that animals and small children cannot get trapped inside the appliance.
- Do not exceed the detergent quantities recommended in the detergent manufacturers' instructions.
- Use stain removal products and bleaches before the wash cycle only when strictly necessary.
- Save water and electricity by only washing full loads (the exact amount depends upon the program used).

## Declaration of conformity

This appliance complies with European safety standards, EC directive 93/68 and EN Standard 60335.

# Appendix

## Specification

TYPE	FRONT LOADING WASHER				
DIMENSION	W598mm x D400mm x H844mm				
WATER PRESSURE	50 kPa ~ 800 kPa				
WEIGHT	68 kg				
WASH and SPIN CAPACITY	5.0 kg (DRY LAUNDRY)				
POWER CONSUMPTION	WASHING	220V / 180W 240V / 180W			
	WASHING AND HEATING	220V / 1800W 240V / 2100W			
	SPIN	MODEL	C1235	C1035	C835
		230V	550W	500W	430W
	PUMPING		30W		
WATER VOLUME	60l (STANDARD COURSE)				
SPIN REVOLUTION	MODEL	C1235	C1035	C835	
	rpm	1200	1000	800	

## **IN CASE THE NEED FOR SERVICING ARISES**

- Don't hesitate to call any AS center nearby with your name, address, telephone number, model number and serial number of your machine when anything wrong with your product occurs.



ELECTRONICS