

NOKIA

User's Guide
Installation Guide

Nokia 610 Car Kit Phone



9362625

Issue 1

DECLARATION OF CONFORMITY

We, NOKIA CORPORATION, declare under our sole responsibility that the product TFE-4 is in conformity with the provisions of the following Council Directive: 1999/5/EC. A copy of the Declaration of Conformity can be found at:

http://www.nokia.com/phones/declaration_of_conformity/

CE 168

Copyright © 2004 Nokia. All rights reserved.

Reproduction, transfer, distribution or storage of part or all of the contents of this document in any form without the prior written permission of Nokia is prohibited.

US Patent No 5818437 and other pending patents.
Tegic Communications, Inc. All rights reserved.

Nokia, Nokia Connecting People, and Navi wheel are trademarks or registered trademarks of Nokia Corporation. Other products and company names mentioned herein may be trademarks or tradenames of their respective owners.

Bluetooth is a registered trademark of Bluetooth SIG, Inc.

Nokia operates a policy of continuous development. Nokia reserves the right to make changes and improvements to any of the products described in this document without prior notice.

Under no circumstances shall Nokia be responsible for any loss of data or income or any special, incidental, consequential or indirect damages howsoever caused.

The contents of this document are provided "as is". Except as required by applicable law, no warranties of any kind, either express or implied, including, but not limited to, the implied warranties of merchantability and fitness for a particular purpose, are made in relation to the accuracy, reliability or contents of this document. Nokia reserves the right to revise this document or withdraw it at any time without prior notice.

The availability of particular products and services may vary by region. Please check with the Nokia dealer nearest to you.

9362625 / Issue 1

Table of contents

For your safety	5	Call waiting service	26
Network services	6	Options during a call	26
About accessories	6	Accepting or refusing an incoming call	27
Using a remote SIM card with Bluetooth wireless technology	7	Using the menu	28
General information	9	Accessing a menu function	28
Overview of the car kit phone equipment	9	List of menu functions	28
Special features	10	Menu functions	31
Before putting your phone into operation	13	Messages	31
Stickers in the sales package	14	Call register	33
Access codes required for the car SIM card	14	Contacts	35
Your car kit phone	15	Tone settings	36
Display SU-11	15	Settings	37
Basic components of the CUW-3 input device	17	Voice tags	46
Getting started	19	Recorder	49
Installing the car SIM card	19	Bluetooth wireless technology	51
Switching on/off and off mode	20	User data	56
Call functions	24	Receiving and forwarding business cards and calendar items	61
Voice dialling	24	Receiving a business card or calendar item	61
Dialling from the contacts (name search)	24	Data transmission	62
Redialling	25	GPRS (General Packet Radio Service)	62
Using the Navi™ wheel to make a call	25	HSCSD (High Speed Circuit Switched Data)	62
List of favourites	25	Reference information	62
		Installation	64
		Your Nokia 610 car kit phone	64
		Safety first	65

Mounting	65
Equaliser settings	68
Function test.....	68
Scope of supply.....	68
Care and maintenance	69
Important safety information	70
Traffic safety	70
Operating environment	70
Electronic devices	70
Pacemakers.....	70
Potentially explosive atmospheres	70
Vehicles	71
Emergency calls	71
To make an emergency call	71
Technical data	72
Glossary	73

For your safety

Read these simple guidelines. Breaking the rules may be dangerous or illegal. Further detailed information is given in this user's guide.



OFF MODE

If wireless phone use is prohibited or when it may cause interference or danger, switch your car kit phone over to off mode. To do so, with ignition on, press and hold . Also remember to switch your mobile phone off if necessary.



ROAD SAFETY COMES FIRST

Remember that the safety of operating a motor vehicle in traffic requires the full attention of all motorists. Only use your car kit phone if traffic conditions permit safe use and check if local laws/regulations restrict the use of mobile phones while driving.



INTERFERENCE

All wireless phones may get interference, which could affect performance.



OFF MODE WHEN REFUELLING

Switch your car kit phone over to off mode at a refuelling point. Don't use near fuel or chemicals. Also remember to switch your mobile phone off if necessary.



OFF MODE NEAR BLASTING

Switch your car kit phone over to off mode where blasting is in progress. Observe restrictions, and follow any regulations or rules. Also remember to switch your mobile phone off if necessary.



QUALIFIED INSTALLATION AND SERVICE

Only a qualified professional may install or repair phone equipment.



CONNECTING TO OTHER DEVICES

When connecting to any other device using Bluetooth wireless technology, read the relevant user's guide for detailed safety instructions. Do not connect incompatible products.



EMERGENCY CALLS

Ensure the phone is switched on and in service.

► Press and hold until **Make an emergency call?** is shown on the display. Confirm by pressing .

► Confirm the security inquiry **Yes** by pressing or cancel by selecting **No** with and pressing .

Give your location. Do not end the call until told to do so.



CALLING

Ensure that the car's ignition is on and that the car kit phone is using either the SIM card from a compatible mobile phone or the car SIM card. Select the desired phone number from the contacts or use the Navi™ wheel to enter the number, then press . To end a call, press . To answer a call, press .



ANTENNA

In order to comply with RF exposure requirements for mobile transmitting devices, a minimum distance of 20 cm must be maintained between the antenna and all persons.



FUSE REPLACEMENT

Replace a blown fuse with a fuse of the same type and size. Never use a fuse with a higher rating!

Network services

The car kit phone described in this guide is approved for use in the (E)GSM 900 and GSM 1800 networks.

A number of features included in this guide are called Network Services. These are special services that you arrange through your wireless service provider. Before you can take advantage of any of these Network Services, you must subscribe to them through your service provider and obtain instructions for their use from your service provider.

Select network services such as call diverting from the related menu of the car kit phone. The chosen settings will then be automatically transmitted to the network operator for configuration of the service. Network service settings are not stored in the car kit phone or on the SIM card.

- ! Some networks may not support all language-dependent characters and/or services.

About accessories



Warning!

Use only accessories approved by the phone manufacturer for use with this particular phone model. The use of any other types may invalidate any approval or warranty applying to the phone and may be dangerous.

For availability of approved accessories, please check with your dealer.

1. Using a remote SIM card with Bluetooth wireless technology

The car kit phone supports Bluetooth wireless technology and Bluetooth SIM access profile.

i Bluetooth wireless technology
Bluetooth wireless technology is an international standard for wireless short-range communication, allowing you to establish a wireless radio connection between your car kit phone and a compatible device supporting Bluetooth wireless technology within a maximum range of 10 metres. Such devices may include, for example, a compatible mobile phone, laptop computer or wireless headset. The wireless connection between the compatible devices established via Bluetooth technology is free of charge for the user.

i Bluetooth SIM Access Profile
Bluetooth SIM Access Profile is an industry standard which allows a device, e.g. a car kit phone, which supports Bluetooth wireless technology to access a SIM card in a compatible mobile phone over a wireless link. The car kit phone is then able to read and write data from/to the remote SIM card inserted in the compatible mobile phone and to log into the GSM network. A separate SIM card inserted in the car kit phone is not required in this case.

You have switched on a compatible mobile phone supporting the Bluetooth SIM Access Profile standard, a valid SIM card is inserted in the compatible mobile phone, Bluetooth wireless technology has been activated, the compatible mobile phone

has been paired with the car kit phone and you get into your car.

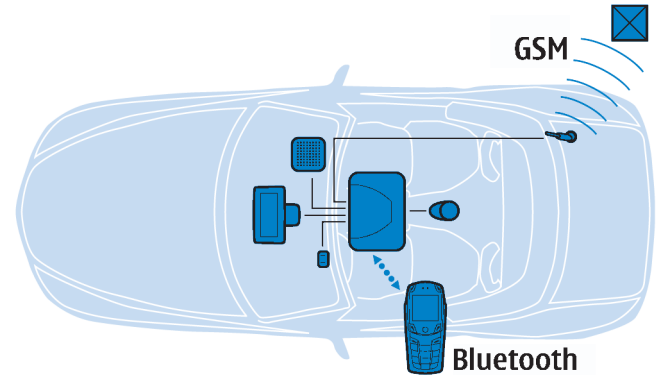

How the GSM/Bluetooth wireless connection works

When the car ignition is switched on, a wireless connection is established between the compatible mobile phone and the car kit phone via Bluetooth SIM Access Profile. The car kit phone requests the compatible mobile phone to log out of the GSM wireless network and to deactivate the mobile phone components required for the GSM connection. The car kit phone then uses Bluetooth SIM Access Profile to access the SIM card inserted in the compatible mobile phone (remote SIM card) and utilises this card's profile to log into the GSM network. Now the car kit phone handles all incoming and outgoing calls and messages while accessing the SIM card of the compatible mobile phone.

With Bluetooth SIM Access Profile, the car kit phone combines the advantages of a fixed installed car phone such as excellent audio quality, use of a compatible, external GSM antenna and optimum ease of operation with the advantages of a car kit installation, e.g. use of the SIM card inserted in a compatible mobile phone or access to the relevant contact data.

And all this time the compatible mobile phone can conveniently be located in the user's briefcase; there is no need for it to be inserted in a cradle for operation. The wireless Bluetooth SIM Access Profile connection between the car kit phone and the compatible mobile phone is upheld either until the compatible mobile phone is moved out of range (e.g. when the user leaves the car) or until the user breaks the connection by pressing a button on the compatible mobile phone to change back to standard operation of the mobile or to switch off the phone.

If desired, a separate car SIM card can be inserted in the car kit phone. This SIM card can be used when the wireless link to the compatible mobile phone established via Bluetooth technology is interrupted or if the car kit phone is to be operated using a permanent car SIM card.

i If you use Bluetooth technology functions regularly, you can deactivate the option "Authorisation request" in the compatible mobile phone. Then connections between the devices via Bluetooth wireless technology can conveniently be made automatically without separate acceptance or authorisation. To do so, scroll to the menu item [View paired devices](#) and select the option [Request authorisation](#) and set it to [Off](#). For further information, see the user's guide applicable for the compatible mobile phone with Bluetooth technology that you are using.

For information on compatible mobile phones, see the Nokia website: <http://www.nokia.com>.

2. General information

Overview of the car kit phone equipment

Your car kit phone is made up of several components, which are described below:

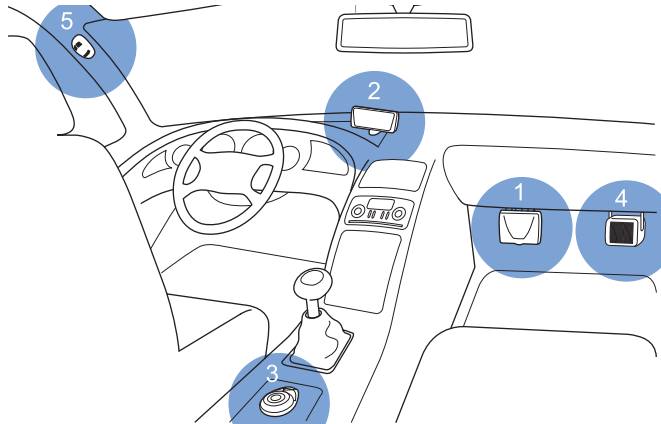

Car kit phone equipment

1. Radio unit TFE-4

The radio unit is an (E)GSM 900 / 1800 car telephone with Bluetooth wireless technology which supports a cable link to a compatible external GSM antenna and further compatible external devices.

2. Display SU-11

The separate display comes with generously sized, easy-to-read fonts, convenient user-customisable display positioning and configurable backlighting, allowing display texts to be easily read.

3. Input device CUW-3

The input device comprises a set of function elements, the Navi wheel and four keys. The input device is specially designed so that accessing key telephone functions is made easier for the user, allowing intuitive operation.

4. Loudspeaker SP-2

A separate loudspeaker is provided for top-quality audio transmission of the acoustic signals from your car kit phone and voice transmission when calls are made. Should you wish to use the loudspeakers belonging to your car radio instead, please ask the service technician who is to install your car kit phone for professional assistance as the car kit phone may not be compatible with your system.

5. Microphone HFM-8

The handsfree microphone supplied in the sales package has been tailor-made for the vehicular environment. State-of-the-art technologies geared for effective echo and noise suppression in automotive systems enable quality results even in poor conditions. Selecting a suitable mounting location may also enhance the performance of the device. For further information, see "Installation" on page 64.

6. System cables PCU-4

A set of cables is included for connection to the power supply and the ignition system and to mute the radio.

7. GSM antenna (not included in the scope of supply)

A compatible external GSM antenna is required for connection to the car kit phone.

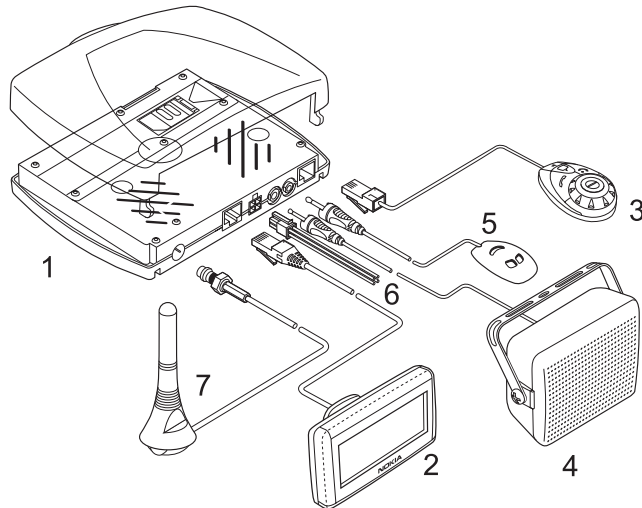

Car kit phone equipment and cable connections

Special features

For enhanced safety and operating comfort of wireless communication in the vehicular environment, this car kit phone is equipped with a variety of special features tailored for automotive applications. A number of these extras are sketched below:

Accessing a remote SIM card via Bluetooth SIM Access Profile technology

This feature allows the car kit phone to access the remote SIM card in a compatible mobile phone. For further information, see "Using a remote SIM card with Bluetooth wireless technology" on page 7.

- ! To be able to use this feature, you will first need to pair the compatible mobile phone with the car kit phone via Bluetooth wireless technology. For further information, see "Bluetooth wireless technology" on page 51.

Voice dialling



Voice dialling is a convenient way to select certain numbers from the contacts, which are then automatically dialled. You may choose as many as 12 of your contact entries and train voice tags to initiate a phone call. To make a voice call from the standby display, just press the  key on the input device and speak the desired voice tag.

- ! Before you can use this feature you will have to record voice tags for contact entries stored in the car kit phone's

contacts. For further information, see "Voice dialling" on page 24 and "Voice dialling" on page 46.

Voice commands



You have a selection of phone functions which can be activated by saying a voice command. As many as three voice tags for the voice commands can be added.

You can activate the voice command in the same way as making a call by using a voice tag. With the display in standby, press the  key on the input device and speak the voice command for the desired function.

- ! Before you can use this feature you will have to record command tags for the desired functions in the car kit phone. For further information, see "Voice commands" on page 48.

Voice recorder



This feature acts as a dictaphone, allowing you to record personal voice memos. You may make up to 10 recordings for a total of five minutes'

recording time. To start recording from the standby display, press and hold the  key on the input device. To play a recorded speech memo, you may either use a personal voice command (e.g. Play memo!) or select the option [Play](#) in the [Record](#) menu.

Copying contact entries from your mobile phone



If you have a compatible mobile phone that supports Bluetooth wireless technology, this feature allows you to copy contact entries from the mobile phone to the car kit phone.

To download the contacts from your compatible mobile, you may either use a personal voice command (e.g. Copy contacts!) or select the option [Download contacts](#) in the [User data](#) menu. For further information, see "Download contacts" on page 56.

Multi-user capability



This feature lets you store personal entries or phone settings under two different user data profiles. For example, now contact entries, voice tags for voice

dialling and voice commands or ringing tones for two users can be saved and then accessed from the car kit phone. Just activate your personal user profile to access your data. For further information, see "Change user" on page 58.

Switchover to wireless headset



This feature supports use of compatible headsets with Bluetooth technology.



You can switch calls over from handsfree mode, where the car kit phone's microphone and loudspeaker system is used, to a wireless headset that is comfortable and easy to use. Press  to switch incoming or ongoing calls over to your wireless headset.



- ! To be able to use this feature, you will first need to pair the compatible wireless headset and the car kit phone and establish a wireless connection between the two devices via Bluetooth technology. For further information, see "Bluetooth wireless technology" on page 51.
- ! In principle, a wireless headset with Bluetooth technology can only establish one Bluetooth wireless connection to another compatible device supporting Bluetooth technology. Therefore, to switch over to a wireless headset with Bluetooth technology, you may need to break an existing Bluetooth wireless connection, for example, to a mobile phone.
- ! If you have already established a Bluetooth SIM Access Profile wireless connection to a compatible mobile phone and wish to switch over to a compatible wireless headset with Bluetooth technology, the additional Bluetooth wireless connection to the headset has to be established from the car kit phone. This can be conveniently done using a voice command. For further information, see "Voice commands" on page 48.

Quick access to the contact entries



A shortcut feature has been provided to make it easier for you to find a desired phone number in the contact entries and make a call.

- ▶ To find a particular contact entry, with the display in standby, scroll with  to the first letter of the name as entered in the contacts and press .

- ▶ Scroll with  to the desired name and press  to dial the number.

- ! Before you can use this feature you will have to make entries for contacts in the car kit phone. For further information, see "Download contacts" on page 56.
- ! You may assign up to 5 phone numbers to any name entered in your contacts. For further information, see "Contacts" on page 35.

Mobile data services using Bluetooth wireless technology

Your car kit phone comes with a convenient feature allowing you to connect compatible external devices such as a compatible laptop computer to the car kit phone using Bluetooth wireless technology.

This means that you can now utilise GSM data services such as GPRS or HSCSD for mobile Internet access for a compatible laptop in the car.

Using a car SIM card

You can also operate the car kit phone using a separate car SIM card that is inserted in the radio unit.

For further information, see "Getting started" on page 19.

Comfortable volume regulation with Navi wheel



Regulate the volume of the ringing tone notifying you of an incoming call simply by scrolling with  as needed.

You can also adjust the loudspeaker volume during an ongoing call with .

Before putting your phone into operation

Please read the information set out below before putting your car kit phone into operation:

- ! The phone is automatically switched on with the car's ignition.

When you switch off your car's ignition, the car kit phone will not be switched off automatically: it remains in service for the period of time that has been set using the [power down timer](#) function. For further information, see "Power down timer" on page 41.

- ! Check your car kit phone equipment regularly to ensure that it is correctly mounted and is working properly.

Using a car SIM card

To operate your car kit phone with a separate car SIM card, you will need to insert a valid car SIM card in the radio unit. For further information, see "Installing the car SIM card" on page 19.

Using a remote SIM card

You can operate the car kit phone using a remote SIM card under the following conditions:

- The remote SIM card is inserted in a compatible mobile phone which supports Bluetooth wireless technology and the Bluetooth SIM Access Profile standard. For information on compatible mobile phones, see the Nokia website: <http://www.nokia.com>.
- To access the remote SIM card, the compatible mobile phone first has to be paired with the car kit phone via Bluetooth wireless technology. For further information, see "Pairing using a Bluetooth passcode" on page 52.
- The compatible mobile phone is on, sufficient battery power is available and Bluetooth wireless technology is activated.

Stickers in the sales package

The stickers that come with your car kit phone are important for service and related purposes.

- ▶ Attach sticker  to your warranty card.

Access codes required for the car SIM card

- PIN code (4-8 digits):

The PIN (Personal Identification Number) protects your car SIM card against unauthorised use. The PIN code is usually supplied with the SIM card.

Some service providers may allow you to switch off the prompt requesting you to enter the PIN at power on.

- PIN2 code (4-8 digits):

The PIN2 code may be supplied with the car SIM card and is required to access some functions.

- PUK and PUK2 codes (8 digits):

The PUK (Personal Unblocking Key) code is required to change a blocked PIN code. The PUK2 code is required to change a blocked PIN2 code.

- ! If these codes have not been supplied with your car SIM card, please contact your service provider.

3. Your car kit phone

Display SU-11

When the car kit phone is ready for use and no characters have as yet been entered, the **standby display** as depicted in the figure is shown. In addition the logo of the network operator is shown.

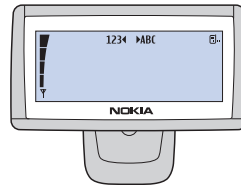

If you wish to activate a function using a voice tag, you will first have to call the **voice display**. To do so from the standby display, press .









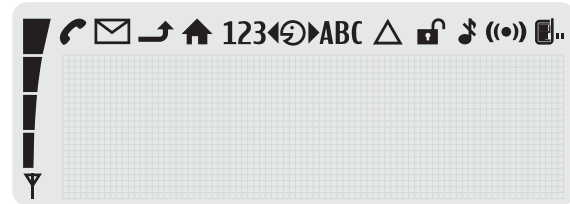







You may adjust the display illumination to optimise performance. For further information, see "Display backlighting" on page 40.

Display indicators

The indicators described below may be shown on the display.











-  Shows the signal strength of the cellular network at the current location. The higher the bar, the stronger the signal.
-  Indicates an ongoing call.
-  You have received one or more text messages. Indicates unread text messages.
-  The call diverting feature is on (network service). See "Call divert (network service)" on page 38.
-  The home zone service is active (network service).
- 123** You may enter numbers.
-  Turn the Navi wheel to the left.
-  You may speak now.
-  Turn the Navi wheel to the right.
- ABC** You may enter letters.









-  Shows that roaming is active.
-  The network has deactivated the encryption function.
-  The ringing tone is switched off.
-  Bluetooth wireless technology is activated, see "Bluetooth wireless technology" on page 51.
-  User profile 1 is in use.
See "Change user" on page 58.
-  User profile 2 is in use.
See "Change user" on page 58.

Additional indicators may be displayed:



Call indicators

-  Indicates an active voice call.
-  Indicates that a voice call has been disconnected.
-  Voice calls have been switched over to the headset.
-  Data communication is active.
-  Fax communication is active.
-  Indicates an active GPRS connection.
-  Indicates an inactive GPRS connection.
-  The call is on hold.



General indicators

-  Indicates a manual network search.
-  Indicates unread text messages. If this indicator is flashing, the memory is full.
-  Indicates a business card is being forwarded.
-  This setting is active.
-  Headset volume can be adjusted.
-  Ringing tone volume can be adjusted.
-  Loudspeaker volume can be adjusted.
-  Backlighting can be adjusted.







Indicators for recorder functions

-  Recorder function is on.
-  The tape is being played back.

Indicators for Bluetooth functions

-  Device with Bluetooth technology has been paired with the car kit phone.
-  Bluetooth wireless technology is activated.



Notification indicators

-  Indicates that an item has been erased.
-  Indicates that your entry is incorrect or not permissible.
-  O.K. (confirms a setting or selection made).
-  Indicates additional information.
-  Indicates a warning or a caution.
-  Your message is being sent (does not indicate that the message has been received).

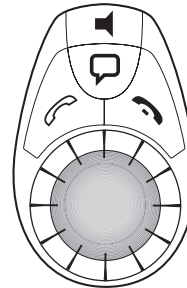
Basic components of the CUW-3 input device



The function selectors include four keys and a Navi wheel. Depending on the setting selected, you may choose from the following options:

-  Press and hold
 - the emergency call function is active.
 For further information, see "To make an emergency call" on page 71.
-  Press
 - to accept an incoming call.
 - to display the list of the last 10 phone numbers you have called.
 - to start dialling a number.
-  Press and hold
 - to delete text, numbers or other entries.
 - to return to the standby display.



Press

- to end a call.
- to delete a character or number entered.
- to return to the previous menu item or display.



Navi wheel

Turn the Navi wheel to adjust the volume of the ringing tone of an incoming call or the loudspeaker volume during an ongoing call. You can also use the Navi wheel to scroll within a menu.



In the standby display, turn the Navi wheel to the left to activate input of a phone number. If you are in the voice display, turning the Navi wheel to the left will scroll through the voice commands and allow you, for example, to select one to be replayed.



In the standby display, turn the Navi wheel to the right to search for a contact entry in alphabetical order. If you are in the voice display, turning the Navi wheel to the right will scroll through the voice tags you have trained for voice dialling a number and allow you, for example, to select one to be replayed.



Press the Navi wheel

to access a function in a particular context:

- to start the menu and select an item.
- to select an item from a list.
- to start options and select an item.



This key activates the following functions from the standby display:

- ▶ **Press** to switch off the ringing tone. An incoming call is indicated by a flashing display.
- ▶ **Press and hold** to put the car kit phone in off mode. Press again to return to the standby display.
- ▶ **Press** to switch incoming or ongoing calls from your car kit phone over to a compatible, paired headset and back as desired.



To restart the car kit phone, press  and hold for longer than 10 seconds.



This key activates the following voice functions from the standby display:

- ▶ **Press** to activate voice dialling and voice commands.
- ▶ **Press and hold** to activate recording (also during ongoing calls).

4. Getting started

Installing the car SIM card

The car kit phone can be used with a separate, own car SIM card. In this case, you will need to insert a SIM card in the radio unit.

⚠ Caution!
Keep all miniature SIM cards out of the reach of small children.

! The SIM card and its contacts can easily be damaged by scratches or bending, so be careful when handling, inserting or removing the card.

- ▶ Switch off the car's ignition before inserting the SIM card.
- ▶ Gently press the catch on the radio unit casing (1) to open and lift the cover (2).

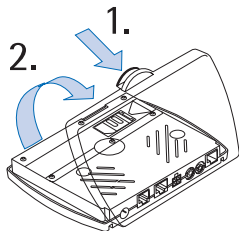

- ▶ Slide the SIM card holder (3) as shown to unlock it.

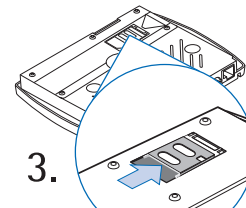

- ▶ Open the SIM card holder by lifting it upwards on one side as depicted in figure (4).

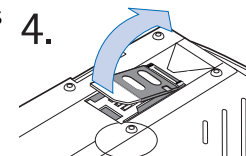

- ▶ Carefully insert the SIM card into the holder (5). Make sure that the SIM card is inserted properly and that the golden contact area on the card is facing you.

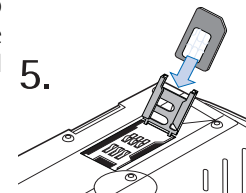

- ▶ Push the SIM card holder down into its original position and lock it into place by sliding it in the direction indicated by the arrow. Close the cover of the radio unit and check to make sure it catches.

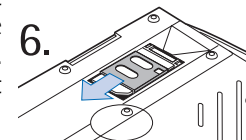

Switching on/off and off mode

Caution!

If wireless phone use is prohibited or when it may cause interference or danger, switch your car kit phone over to off mode. The car kit phone is then deactivated, even if the car ignition is on.

Switching on the car kit phone

To switch on your car kit phone, simply turn the ignition key. Your car kit phone is connected to the ignition system, so that turning the ignition on automatically switches your car kit phone on. Depending on the SIM card in use when the car kit phone was last used, different prompts will be displayed:

Initial operation, a SIM card has not been assigned to the active user profile

If you have not assigned a SIM card to the car kit phone or to the active user profile, you will be prompted to select the desired display language to be used in the car kit phone for the active user profile. Then you can choose whether you wish to use the active user profile with the car SIM card or a remote SIM card, i.e. the SIM card installed in a compatible mobile phone.

- Operation using a remote SIM card
The car kit phone will automatically begin searching for a compatible mobile phone which supports Bluetooth wireless technology and the Bluetooth SIM Access Profile standard. Select the desired device from the list of devices

found and pair it with your car kit phone using a Bluetooth SIM Access Profile passcode. For further information, see "Pairing using a Bluetooth passcode" on page 52.

If you are prompted to enter a PIN code, enter the PIN code of the remote SIM card installed in the compatible mobile phone. This will appear on the display as ****. Press  to confirm. The car kit phone will then ask if you wish to save the PIN code for a later automatic authorisation.

If the devices have been paired successfully and the PIN code has been correctly entered, the remote SIM card of the compatible mobile phone selected will be assigned user profile 1. The car kit phone then asks whether you wish to copy the contact entries stored on the remote SIM card and in the compatible mobile phone to the car kit phone memory. Afterwards, the car kit phone accesses the SIM card installed in the compatible mobile phone to log into the GSM radio network.

If no compatible mobile phone is shown in the list of devices with Bluetooth SIM Access Profile, you can select the car SIM card if it has been installed in the radio unit. The car kit phone will then use this SIM card for operation. For further information, see "Installing the car SIM card" on page 19.

- Using the car SIM card
If the message **SIM rejected** appears on the display although a SIM card has been properly inserted into the radio unit, contact your network operator or service provider.
If you are prompted to enter a PIN code, enter the PIN code belonging to the car SIM card. This will appear on the display as ****. Press  to confirm.

If the PIN code has been entered correctly, the car SIM card will be assigned user profile 1. The car kit phone then asks if you wish to copy the contact entries stored on the car SIM card to the car kit phone memory.

- The car kit contact entries represent those in the internal car kit phone memory and not those on the car SIM card in use.

Remote SIM card assigned to active user profile

If you have already assigned the SIM card inserted in a compatible mobile phone to the active user profile in the car kit phone, when the car ignition is switched on the car kit phone will use Bluetooth wireless technology to automatically search for the compatible mobile phone in which the SIM card was installed the last time the car kit phone was used. If this device is found in the list of devices with Bluetooth technology and you have activated the automatic PIN code entry, i.e. no further authorisation request is required, the car kit phone will automatically log in to the GSM network via the SIM card of the compatible mobile phone. In this case, you will not be prompted for input when switching on the car ignition as login is done automatically.

- If you use Bluetooth technology functions regularly, e.g. to copy contact entries to the car kit phone memory from a compatible mobile phone, you can deactivate the option "Authorisation request" in the compatible mobile phone. Now connections between the devices via Bluetooth wireless technology can conveniently be made automatically without separate acceptance or

authorisation. To do so, scroll to the menu item [View paired devices](#) and select the option [Request authorisation](#) and set it to [Off](#). For further information, see the user's guide applicable for the compatible mobile phone with Bluetooth technology that you are using.

However, if you have not saved the PIN code belonging to the SIM card installed in the compatible mobile phone, you will have to enter the PIN code each time the car ignition is switched on.

If the remote SIM card of the compatible mobile phone has been assigned to the active user profile but is not found, the car kit phone will display the following list of options.

- [Reconnect remote SIM card](#)
The search for the remote SIM card assigned to the active user profile will be repeated.
- [Change user](#)
This feature lets you change the active user profile. For further information, see "Change user" on page 58.
- [Use car SIM for this session](#)
The car SIM card can be assigned to the active user profile temporarily.
- The car SIM card will only be assigned to the active user profile as long as the car ignition is turned on. If the compatible mobile phone should not be within range for a Bluetooth wireless connection, for example, you can use the car SIM card inserted in the radio unit to temporarily access your standard user profile. If you switch off the ignition and switch it on again, the car kit phone will automatically

begin to search for the remote SIM card of the compatible mobile phone.

- **Assign SIM card**

Either a remote SIM card or the car SIM card can be assigned to the active user profile.

Car SIM card assigned to active user profile

If you have assigned a car SIM card, i.e. the SIM card inserted in the radio unit, to the active user profile in the car kit phone and the message **SIM rejected** appears on the display although a SIM card has been properly inserted into the radio unit, contact your network operator or service provider.

If you are prompted to enter a PIN code, enter the PIN code belonging to the car SIM card. This will appear on the display as a series of asterisks ****. Press  to confirm.

If the PIN code has been entered correctly, the car kit phone logs into the GSM radio network using the car SIM card. The car kit phone then asks if you wish to copy the contact entries on the car SIM card to the car kit phone memory, if no contact entries have as yet been saved in the car kit phone memory.

- **i** The car kit contact entries represent those in the internal car kit phone memory and not those on the car SIM card in use.

Switching off the phone

When you switch off your car's ignition, the car kit phone will not be switched off automatically: it remains in service for the period of time that you have set using the **power down timer**. If you are engaged in an active call the car kit phone will not automatically switch off at the end of this time. The power down timer will not start to count down until after the active call is over.

- **i** The factory setting for the **power down timer** is zero minutes.

Off mode



To change over to off mode when your car's ignition is switched on:

- ▶ Press and hold .

- ▶ Then press and hold .

When your car kit phone is in off mode, the display as depicted in the figure above is shown.

- ▶ To put your car kit phone back into service, press .

- ▶ Follow the instructions shown on the display.

- **i** When the car kit phone is in off mode, an established wireless Bluetooth SIM Access Profile link between the car kit phone and the compatible mobile phone remains active. This means that the GSM transmitter and receiver

components of the compatible mobile phone stay switched off.

- ! If the wireless Bluetooth SIM Access Profile link between the car kit phone and the compatible mobile phone is interrupted (e.g. if the compatible mobile phone is moved out of range when the user leaves the car), the GSM transmitter and receiver components of the compatible mobile phone are automatically switched on again and the mobile phone logs into the GSM network using its SIM card. In this case, when wireless phone use is prohibited or when it may cause interference or danger, ensure that the car kit phone is changed over to off mode and be sure to switch off the compatible mobile phone.

5. Call functions

Voice dialling



You can make a phone call simply by saying a voice tag that has been added to a number in the contacts. Name tags may be added to up to 12 of the numbers stored in your contacts. Any spoken word (or words) such as the name of a person can be used as a voice tag to voice dial a call.

Before using voice dialling, note that:

- Voice tags are not language dependent. They are dependent on the speaker's voice.
- Voice tags are sensitive to background noise. Record them and make calls in a quiet environment.
- When recording a voice tag or making a call by saying a voice tag, speak clearly into the microphone.
- Very short names are not accepted. Use long names and avoid similar names for different numbers.
- ! You must say the name exactly as you said it when you recorded it. This may be difficult in, for example, a noisy environment or during an emergency, so you should not rely solely upon voice dialling in all circumstances.
- ! Before you can use this feature you will have to record voice tags for numbers stored in the car kit phone's contacts. For further information, see "Voice tags" on page 46.









- ▶ To voice dial a number, press  and the message **Speak now** will appear on the display.
- ▶ Say the voice tag belonging to the desired number loudly and clearly.

To indicate that it has recognised the voice tag, your car kit phone will play back the voice tag as recorded and then automatically dial the number assigned to it 1.5 seconds later.

Dialling from the contacts (name search)



You can call a number simply by selecting a name from the contact entries:

- ▶ With the display in standby, scroll with  to the desired letter of the alphabet in the contacts and press  to open the list of names beginning with this letter.
- ▶ Scroll with  to the desired name and press  to dial the number stored with the name.
- ! You can assign as many as five phone numbers to an entry in the contacts with different symbols used to differentiate the entries. If no other symbol is selected, the first number saved under a name is indicated with  (General). Other number types used to differentiate entries are  (Mobile),  (Home),  (Office) and  (Fax).



To call any one of the other numbers stored for a name:

- ▶ Press and scroll with to the desired symbol or phone number.
- ▶ Press to dial the number.

Redialling

To redial a number you have recently dialled, you can view a list of up to 10 numbers that you have last called.

- ▶ With the display in standby, press .
- ▶ Scroll with to the desired number or name.
- ▶ Press to dial the number.

Using the Navi™ wheel to make a call

You can use the Navi wheel to enter a phone number and make a call.

- ▶ With the display in standby, scroll with to the first number in the phone number and press to select it.
- ▶ Repeat this step for the other numbers making up the desired number until the complete phone number is shown on the display.
- ▶ Press to dial the number.

List of favourites

This list may contain up to 12 name tags you have assigned to phone numbers. For further information, see "Voice dialling" on page 24. It is provided for your convenience to allow you to quickly access numbers you frequently call.



- ▶ You can call the list from the standby display quickly and easily.
- ▶ Press .
- ▶ Scroll with to the desired entry and press to select it.
- ▶ Follow the instructions shown on the display.
- ▶ Press to dial the number.

Call waiting service



If the function **Call waiting** is activated, You will be notified of any incoming call while you have another call in progress. This feature will allow you to accept this call (network service).

The following settings are available for this feature:

- **Activate**
This option will activate the call waiting service.
 - **Cancel**
This option will deactivate the call waiting function.
 - **Check status**
Select this option if you wish to know whether or not this service is currently active for your car kit phone (network query).
- ▶ Press  to accept an incoming call while you are engaged in an active call. The first call will then be placed on hold.
- ▶ Press  to switch between the active call and the call on hold.
- ▶ Press  to end the currently active call and return to the call on hold.



For further information, see "Settings" on page 37.

Options during a call

The following options are available to you during an active call:



- **Send DTMF**
- **Mute**
- **Contacts**

To view the list of options:

- ▶ Press  during an active call.
- ▶ Scroll with  to the desired option and press  to select it.

Send DTMF

DTMF tone strings can be used to send passwords or to access your answerphone, for example.

- ▶ Scroll with  to the desired number and press  to select it.
- ▶ Repeat this step to select the other numbers in the string.
- When a number has been selected, it is immediately sent as a DTMF tone.
- ▶ Press  to exit this option.

- Pressing  returns to the call display. Any call in progress will remain active.

Mute call





If desired, you can mute a call in progress by selecting the option **Mute**, which switches off the microphone. The message **Muted** then appears on the display.

- ▶ Press  to unmute the microphone.



Contacts

During a call, you may wish to view contact entries to check a number, for example, or to give the caller a particular number.

To view contacts:

- ▶ Scroll with  to the contact entries.
- ▶ Press  to exit the contacts.

Accepting or refusing an incoming call

- ▶ Press  to accept an incoming call and, when finished, press  to end it.
- ▶ Press  to refuse an incoming call.

If the function **Divert if busy** has been activated (network service) and your incoming calls are directed to another number such as your voice mailbox number, any call you have refused will also be diverted to this number. For more information, see “Call divert (network service)” on page 38.

6. Using the menu

The Nokia 610 car kit phone offers you an extensive range of functions, which are grouped in menus.

Accessing a menu function

To access the menu from the standby display, press . You can then navigate the menu using the following keys:



Turn the Navi wheel to the left to scroll up through a list of options.



Turn the Navi wheel to the right to scroll down through a list of options.



Press the Navi wheel to select a desired option.



Press this key to delete an entry made. Or press this key to return to the previous menu level (see the list of menu functions). Press and hold this key to clear the display and return to the standby display.

List of menu functions

► Messages

- Inbox
 - Call
 - Reply with template
 - Save as template
 - Delete
 - Copy to phone
- Message settings
 - Message centre number
 - Reply via same centre
- View templates
 - Send
 - Delete

► Call regist.

- Missed calls
- Received calls
- Dialed numbers

► Contacts

- Search
- Delete
- Memory status

► Tones

- Ringing volume
- Ringing tone

- Warning tones
- ▶ Settings
 - Set time and date
 - Set the time
 - Time format
 - Set the date
 - Date format
 - Call settings
 - My number sending
 - Set by network
 - On
 - Off
 - Call divert
 - Divert all voice calls
 - Divert if busy
 - Divert if not answered
 - Divert if out of reach
 - Divert if not available
 - Cancel all divers
 - Automatic answer
 - Off
 - On
 - Call waiting
 - Activate
 - Cancel
 - Check status
 - Phone settings
 - Language
 - Backlight settings
 - Cell info display
 - On
 - Off
 - Network selection
 - Automatic
 - Manual
 - Power down timer
 - Voice mailbox
 - Listen to voice messages
 - Voice mailbox number
 - GPRS modem
 - Security settings
 - PIN code request
 - Change PIN code
 - Closed user group
 - Default
 - On
 - Off
 - Fixed dialling
 - On
 - Off
 - Number list
 - Equaliser settings
 - Loudspeaker
 - Radio loudsp.
 - Restore factory settings

► Voice

- Voice tags
 - New voice tag
 - List of voice tags
 - Play
 - Change
 - Delete
- Voice commands
 - New voice command
 - List of voice commands
 - Play
 - Change
 - Delete

► Recorder

- Record
- Play
- Delete

► Bluetooth

- Search for audio enhancem.
- View active devices
- View paired devices
 - Create connection
 - Delete pairing
 - Request authorisation
 - Edit Bluetooth name (accessory)
- Bluetooth name (car kit phone)

- Allow second connection
- Visibility

► User data

- Download contacts
- Change to user 1/2
- Settings for user 1/2
 - Assign SIM card
 - View active SIM card
 - Download settings
 - SIM and phone mem.
 - SIM memory
 - Phone memory

7. Menu functions

Messages



You can receive and read short text messages on your car kit phone and either call the sender back or send an answering SMS using a message template (network service). However, before you can send your own short messages, you will have to make some necessary [Message settings](#).

- ! Remember that traffic safety comes first. Don't use a hand-held phone while driving and only use the features offered by your car kit phone when traffic conditions permit this.
- ! When sending messages via the SMS network service, your car kit phone may display the words [Message sent](#). This is only an indication that the message has been sent by your car kit phone to the message centre number programmed into your phone. This does not mean that the message has been received at the intended destination.

Inbox



When you have received an SMS, the  indicator and the number of new messages are shown on the display along with the notification [1 new message received](#).





Any short messages sent to your car kit phone are shown in the order in which they are received.

- ! If you have established a Bluetooth SIM Access Profile connection to a compatible mobile phone, all short messages received by the car kit phone are automatically forwarded to this compatible mobile phone.



Unread text messages are indicated by , whilst read text messages are indicated by the  symbol.

A flashing SMS indicator  means that the message memory is full. To be able to send or receive a new message, you will first have to delete some of the old ones.

If you have received more than one text message:

- ▶ Select the [Messages](#) menu and press  to open it.
- ▶ Select the [Inbox](#) option and press  to view the list of messages.
- ▶ Scroll with  to the desired message and press  to read it.
- ▶ Scroll with  to either browse through the message or display the message itself, the sender or sender's phone number, and the date and time the message was received.

Your car kit phone comes with a number of options for handling the message selected.

- ▶ Press .
- ▶ Scroll with  to the desired option and press  to select it.

Call

Select this option to make a call to the sender's phone number.

Reply with template

You can reply to a short message using a template that you have prepared yourself. Select the option [Reply with template](#) to view the list of the templates stored in your car kit phone.

Save as template

This convenient option lets you save a received SMS as a template. To use the template, select the option [Reply with template](#) to view the list and send the message.

Erase

Select this option to delete a short message.

Message settings

To be able to send short messages, you first need to make some settings on your car kit phone.

Message centre number





You receive this number from your service provider.

- This option saves the phone number of the message centre, which you need to send text messages.

Reply via same centre (network service)

Replies to short messages are typically handled by the SMS centre which the sender subscribes to. Selecting [Reply via same centre](#) will allow the recipient of your message to send you a reply via your message centre.

To make these settings, with the display in standby:

- ▶ Press .
- ▶ Scroll with  to the menu item [Message settings](#) and press  to select it.
- ▶ Scroll with  to the desired option and press  to select it.
- ▶ Follow the instructions on the display.

View templates

Your car kit phone can save up to 10 templates to be sent as short messages. Five standard templates come with your car kit phone; you may save 5 further templates taken from short messages sent to you. The following options are available:











Send

The template selected will be sent.

Erase

Use this option to erase any templates that you have taken from short messages sent to you and then saved.

To view the list of text message templates, with the display in standby:

- ▶ Press .
- ▶ Scroll with  to the [Messages](#) menu and press  to view the options.
- ▶ Scroll with  to [View templates](#) and press  to view the list.
- ▶ Scroll with  through the list of templates and press  to select the desired template.
- ▶ Press  to confirm the selection.
- ▶ Scroll with  to the desired option and press  to select it.
- ▶ Follow the instructions shown on the display.

i While you may erase the templates you have saved from short messages sent to you, please note that you cannot delete the 5 standard templates stored in the car kit phone memory.



Call register



The phone registers the phone numbers of missed, received, and dialled calls and the time and date of your calls.







- !** The phone registers missed and received calls only if the network supports these functions and if the phone is switched on and within the network's service area.
- i** In these lists you can view up to 10 of the last calls made to your phone or received or up to 10 numbers you have last dialled. They are provided for your reference. The most current item is shown at the top of the list.

Three options are available for each of the items in the call register: [Call](#), [Time of call](#) or [Delete](#).

- ▶ Select an entry in the desired list and press .
- ▶ Scroll with  to the desired option and press  to select it.
- ▶ Follow the instructions shown on the display.







Missed calls

To view a list of up to 10 of the latest registered calls, with the display in standby:

- ▶ Press .
- ▶ Scroll with  to the **Call regist.** menu and press  to open it.
- ▶ Scroll with  to **Missed calls** and press  to view the list.
- ▶ Scroll with  through the list.
- ▶ Press and hold  to return to the standby display.

Received calls







To view a list of up to 10 registered numbers of the latest calls you have received, with the display in standby:

- ▶ Press .
- ▶ Scroll with  to the **Call regist.** menu and press  to open it.
- ▶ Scroll with  to **Received calls** and press  to view the list.
- ▶ Scroll with  through the list.

Dialled numbers

You can use a shortcut to view the list of up to 10 of the last-dialled numbers with the display in standby: press and hold .

Alternatively, to view the list of last-dialled numbers, with the display in standby:

- ▶ Press .
- ▶ Scroll with  to the **Call regist.** menu and press  to open it.
- ▶ Scroll with  to **Dialled numbers** and press  to view the list.
- ▶ Scroll with  through the list.

Contacts



All of the entries you make in the contacts are saved in the internal car kit phone memory. You can also copy entries from a SIM card or a compatible mobile phone that supports Bluetooth wireless technology to your car kit phone. For further information, see "Download contacts" on page 56.

For each user profile, up to 500 names can be stored in the car kit phone memory together with numbers for each name. For further information, see "Querying the memory status" on page 36.

- ! If the number of contact entries to be copied from the memory of a compatible mobile phone via Bluetooth wireless technology should exceed the available space in the car kit phone memory, not all of the entries will be copied.

You can assign up to five phone numbers for each name. When you select a name from the contact entries, for example, to make a call, the general number is used by default unless you select another number.

Searching for names and numbers

You can access the list of names and phone numbers quickly from the standby display:

- ▶ Scroll with to the first letter of the desired name and press to select it.
- ▶ You can now view all the names stored in your contacts list which start with the letter selected. They are listed in alphabetical order.
- ▶ Scroll with to the desired name in the list.
- ▶ To make a call to this person, press .
- ▶ To end the call, press .
- ▶ To return to the standby display, press .

For further information, see "Dialling from the contacts (name search)" on page 24.

Erasing contact entries



You can erase one or more names and the related numbers from the contacts.

- ▶ With the display in standby, select the **Contacts** menu and press to open the contacts.
- ▶ Scroll with to **Add contact** and press to select this option.
- ▶ Scroll with to the desired option and press to select it.
- ▶ Follow the instructions shown on the display.

Querying the memory status

This option allows you to view the free storage space in the car kit phone memory (in %).





With the display in standby:

- ▶ Select the **Contacts** menu and press .
- ▶ Scroll with  to the item **Memory status** and press  to select it.
- ▶ You can now view the memory status on the display.

Tone settings



You can choose the desired ringing tone for incoming calls, change the volume, and switch warning tones on or off as desired.

- ▶ Use the Navi wheel  to regulate the volume of the ringing tone when the car kit phone is ringing to notify you of an incoming call or to change the loudspeaker volume during a call in progress.
 - ▶ Select **Tones** and press  to open the menu.
 - ▶ Scroll with  to the desired option and press  to select it.
 - ▶ Follow the instructions shown on the display.

Ringling volume

This option sets the loudspeaker volume for an incoming call.

Ringling tone

This option offers you a range of ringing tones to choose from. Select the one you would like to have notify you of an incoming call.

Warning tones

This option lets you activate or deactivate special notification tones.







Settings



You may customise a number of the settings in your car kit phone.



- ▶ To make any of the settings below, select the **Settings** menu from the standby display and press  to open it.

Setting the time and date



- ▶ Scroll with  to the **Time settings** item and press  to select it.
- ▶ Scroll with  to **Set the time** and press  to select this option.
- ▶ Scroll with  to set the hour. Press  to take over the setting and continue with the minutes.
- ▶ Repeat the above step to set the minutes.
- ▶ Repeat the above procedure to access the options **Time format**, **Set the date**, and **Date format** to make the desired settings.

Call settings

This option lets you set a variety of call features. To make call settings, with the display in standby:

- ▶ Select the **Settings** menu and press  to open it.
- ▶ Scroll with  to the **Call settings** item and press  to select it.

Own number sending (network service)

- **Set by network**
This will activate the setting you have agreed with your network operator.
 - **On**
Selecting this option will activate your caller ID: the person you are calling will then be able to view your car kit phone number.
 - **Off**
If you do not wish your number to be sent to the called party, use this option to deactivate your caller ID.
- ▶ Scroll with  to the desired option and press  to select it.





Call divert (network service)



With **Call divert** you can direct your incoming calls to another number, for example, to your voice mailbox number. For details, contact your service provider.

Your car kit phone offers you a wide variety of options to choose from:

- **Divert all voice calls**
This option will divert all incoming voice calls.
- **Divert if busy**
Select this option to divert voice calls when your number is busy or when you reject an incoming call.
- **Divert if not answered**
This option will divert all voice calls you fail to answer.
- **Divert if out of reach**
Select this option to divert voice calls when you are out of reach of the network.
- **Divert if not available**
This option will divert all voice calls you receive when you are not available.
- **Cancel all divers**
Use this option to cancel any active divert options.

To make call divert settings, with the display in standby:

- ▶ Select the **Settings** menu and press  to open it.
- ▶ Scroll with  to the **Call settings** item and press  to select it.
- ▶ Scroll with  to **Call divert** and press  to select this option.

- ▶ Scroll with  to the desired function and press  to select it.







You can select any of four options for each of the divert features offered:

- **Activate**
This option lets you select the number you wish to direct diverted voice calls to: your **voice mailbox** or any other number.
- **Cancel**
Select this option for any call divert feature that is not to be activated.
- **Check status**
This option allows you to check the status of a call divert feature.
- **Delay**
Select this option to set the time period after which an incoming voice call is to be diverted if not answered.
 - The original factory setting for the delay time is 5 seconds.
 - Active call divers are shown by an indicator on the display. For further information, see "Display indicators" on page 15.

Automatic answer



This feature will cause any incoming call to be automatically answered after the first ring whenever your car kit phone is on and off mode is not active. You can switch this feature on or off as desired.

To activate the automatic answer function, with the display in standby:

- ▶ Select the **Settings** menu and press  to open it.
- ▶ Scroll with  to the **Call settings** item and press  to select it.
- ▶ Scroll with  to **Automatic answer** and press  to select this option.
- ▶ Scroll with  to the desired setting **On** or **Off** and press  to select it.

Call waiting (network service)







If the function **Call waiting** is activated, you will be notified of any incoming call while you have another call in progress. This feature will allow you to accept this call.

- ▶ Press  to accept an incoming call while you are engaged in an active call. The first call will then be placed on hold.
- ▶ Press  to switch between the active call and the call on hold.
- ▶ Press  to end the currently active call and return to the call on hold.

You may choose from three options for this function:

- **Activate**
This option will activate the call waiting service.
- **Cancel**
This option will deactivate the call waiting function.
- **Check status**
Select this option if you wish to know whether or not this service is currently active for your car kit phone (network query).

To activate call waiting, with the display in standby:

- ▶ Select the **Settings** menu and press  to open it.
- ▶ Scroll with  to the **Call settings** item and press  to select it.
- ▶ Scroll with  to **Call waiting** and press  to select this option.
- ▶ Scroll with  to the desired setting and press  to select it.







Phone settings

Select this option to customise your car kit phone settings.

Display text language







This option allows you to select the language that display texts are to be shown in. If **Automatic** is selected, the phone selects the language according to the information stored on the SIM card.

To set the display text language, with the display in standby:

- ▶ Select the **Settings** menu and press  to open it.
- ▶ Scroll with  to the **Phone settings** item and press  to select it.
- ▶ Scroll with  to **Language** and press  to select this option.
- ▶ Scroll with  to the desired language and press  to select it.

Display backlighting

You can adjust the brightness of the display's backlighting for better viewing comfort. To adjust the backlighting, with the display in standby:

- ▶ Select the **Settings** menu and press  to open it.
- ▶ Scroll with  to the **Phone settings** item and press  to select it.
- ▶ Scroll with  to **Backlight settings** and press  to select this option.
- ▶ Scroll with  to the desired backlighting setting and press  to select it.

Cell info display







When this function is activated, information about the radio cell you are currently using will be shown on the display. However, you can only use this network service if the phone is booked into a cellular network based on Micro Cellular Network (MCN) technology.

Network selection

The cellular network to which your car kit phone is to be connected can be selected either manually or automatically.

- **Automatic**
Your car kit phone will automatically select a suitable available cellular network in the area.
- **Manual**
You can view a list of available cellular networks and select any network that has a roaming agreement with your home network operator. The car kit phone stays in manual mode until the automatic mode is selected or another SIM card is inserted into the phone.

To select the desired cellular network, with the display in standby:







- ▶ Select the **Settings** menu and press  to open it.
- ▶ Scroll with  to the **Phone settings** item and press  to select it.
- ▶ Scroll with  to **Network selection** and press  to select this option.
- ▶ Scroll with  to the desired network and press  to select it.
- ▶ Follow the instructions shown on the display.

Power down timer

Your car kit phone comes with a power down delay that keeps your phone in service for the period of time set even when the car's ignition has been switched off. After you have switched off the ignition, the car kit phone remains in operation for the time set in the **Power down timer**. If you are engaged in an active call when the ignition is switched off, the power down timer will not begin the countdown until the active call has ended.

- The original factory setting for the power down timer is zero minutes. The power down delay is limited to a maximum delay time of 24 hours.
- ! Remember that your car kit phone runs off the car battery.
 - When setting the power down timer, take care not to drain your car battery.

To set the power down timer, with the display in standby:

- ▶ Select the **Settings** menu and press  to open it.
- ▶ Scroll with  to the **Phone settings** item and press  to select it.
- ▶ Scroll with  to **Power down timer** and press  to select this option.
- ▶ Scroll with  to set the time as desired.
- ▶ Press  to activate the timer.

A message on the display will notify you that the power down timer has been set.







Voice mailbox

Your service provider may offer you a voice mailbox service, which you have to install before you can receive voice messages. To access this mailbox you may need to save the number to your car kit phone. Your service provider will give you further information on this service and let you know the number of your voice mailbox.

The voice mailbox features are available for the active device that is currently accessing the SIM card data.







Entering your voice mailbox number

You will obtain the number of your voice mailbox from your service provider upon subscription to this service. To enter it in your car kit phone, with the display in standby:

- ▶ Select the **Settings** menu and press  to open it.
- ▶ Scroll with  to **Voice mailbox** and press  to select this option.
- ▶ Scroll with  to **Voice mailbox number** and press  to select this option.
- ▶ Use the Navi wheel number editor to enter the number.
- ▶ If you should select an incorrect number, press  to delete it.
- ▶ To save the number, press "OK" in the Navi wheel number editor or press .

Listening to voice messages

To listen to voice messages, with the display in standby:

- ▶ Select the **Settings** menu and press  to open it.
- ▶ Scroll with  to the **Voice mailbox** item and press  to select it.
- ▶ Scroll with  to **Listen to voice messages** and press  to select this option.
- ▶ Press and hold  to dial your voice mailbox direct.



GPRS modem settings (network service)





You can use your car kit phone as a modem to enable GPRS connectivity. Note, however, that you will need a GPRS access point before you can do so. Contact your network operator or service provider for information.

Before you can use GPRS:

- You need to subscribe to the GPRS service of your network operator or service provider.
- For the relevant information on the availability of GPRS and the necessary settings, contact your network operator or service provider.
- The settings required to use GPRS applications have to be saved to your car kit phone.

To set up a GPRS access point, with the display in standby:

- ▶ Select the **Settings** menu and press  to open it.
- ▶ Scroll with  to the **GPRS modem** item and press  to select it.

- ▶ To set up a new GPRS access point or to change an existing one, press  again.
- ▶ Press  to open the option [Edit access point?](#) and enter the alphanumeric characters of the GPRS access point using the Navi wheel text editor to enter the characters.
- ▶ To save the name of the access point, press "OK" in the Navi wheel text editor or press .
- ▶ If you have made a mistake in selecting a character, press  to delete it. Press and hold this key if you wish to erase the complete entry.

For further information and to download modem driver software for your computer and/or laptop computer, visit the Nokia website at www.nokia.com.

Charges for GPRS and related applications

You may be charged for GPRS data transmission or for an application which uses GPRS. For details of charges, contact your network operator or service provider.

Security settings

Caution!

For some security settings (for example, when calls are limited to closed user groups or fixed dialling numbers), you may find that, in some networks, emergency calls to certain numbers (e.g. 112 or other official emergency call numbers) are blocked. You may first need to turn off these features before you can make an emergency call.

PIN code request (available for car SIM card only)

Use this option to set the car kit phone to ask for the PIN code of the car SIM card installed in the radio unit whenever the phone is switched on. Remember that some providers do not allow the PIN code request function to be deactivated.

PIN code change (available for car SIM card only)

This option lets you change the PIN code of the car SIM card installed in the radio unit of your car kit phone. Remember that these codes may only include the numbers 0 to 9.

For further information, see "PIN code" on page 73.

Closed user group

This is a network service which specifies the group of people you can call or who can call you. For further information, contact your network operator or service provider.

You can choose from three options for this function:

- **Default**
The settings made by your service provider are active.
- **On**
The closed user group service is active.
- **Off**
The closed user group service is deactivated.

Fixed dialling numbers (only available for the car SIM card)



You can restrict your outgoing calls to selected phone numbers, if this function is supported by your car SIM card. To save and edit the numbers on this list, you need the PIN2 code.





- If you wish to use this feature when accessing the SIM card of a compatible mobile phone connected to your car kit phone via Bluetooth SIM Access Profile technology, you will have to make the corresponding settings in the compatible mobile phone. For further information, see the user's guide applicable for the compatible mobile phone with Bluetooth technology that you are using.

You can choose from three options for this function when using the car SIM card installed in your car kit phone:

- **Off**
The fixed dialling numbers function is deactivated.
- **Number list**
This option allows you to view the phone numbers that may be used for outgoing calls.
- **On**
The fixed dialling numbers function is active.

To set up fixed dialling numbers, with the display in standby:

- ▶ Select the **Settings** menu and press  to open it.
- ▶ Scroll with  to the **Security settings** item and press  to select it.

- ▶ Scroll with  to **Fixed dialling** and press  to select this option.
- ▶ Scroll with  to the desired option and press  to select it.
- ▶ Follow the instructions shown on the display.





For further information, see "Access codes required for the car SIM card" on page 14.

Equaliser settings

Your car kit phone supports a variety of options for output over a loudspeaker:

- Direct connection to the SP-2 loudspeaker supplied in the sales package.
- Connection to a compatible car radio loudspeaker over an additional relay that switches audio output over to the loudspeaker (not included in the scope of supply). Please ask the service technician who is to install your car kit phone for professional assistance.
- Connection to compatible car radio loudspeakers via the audio line-in of your car radio. You will need to adjust the audio level suitably if this option is selected.



To make the desired setting, with the display in standby:

- ▶ Select the **Settings** menu and press  to open it.
- ▶ Scroll with  to the **Equaliser settings** and press  to select it.
- ▶ Scroll with  to **Loudspeaker** or **Radioloudsp.** and press  to select the desired option.

Restore factory settings

You can reset all of the menu settings to the original factory settings.

With the display in standby:

- ▶ Select the **Settings** menu and press  to open it.
- ▶ Scroll with  to the **Restore factory settings** and press  to select it
- ▶ Follow the instructions shown on the display.

Caution!

If you have erased a setting, you cannot undo this operation. The data is irretrievably lost.

Voice tags



Before recording voice tags or using voice dialling, you will need to be aware of some essential facts:











- Voice tags are not language dependent. They are dependent on the speaker's voice.
 - Voice tags are sensitive to background noise. Record them and make calls in a quiet environment.
 - When recording a voice tag or making a call by saying a voice tag, make sure to speak clearly into the microphone.
 - Very short names are not accepted. Use long names and avoid similar names for different numbers.
- ! You must say the name exactly as you said it when you recorded it. This may be difficult in, for example, a noisy environment or during an emergency, so you should not rely solely upon voice dialling in all circumstances.

Voice dialling

You can assign voice tags to phone numbers and your car kit phone will automatically try to dial the number when it recognises the tag.









Recording a new voice tag

This option lets you record a new voice tag, assign it to a phone number, and save it in the car kit phone memory. You may save up to 12 voice tags with the related numbers per user profile in your car kit phone. A voice tag can be any spoken word (or words) such as the name of a person.

- ▶ To record a **New voice tag**, select the **Voice** menu in the standby display and press  to open it.
- ▶ Scroll with  to the item **Voice tags** and press  to select it.
- ▶ Scroll with  to **New voice tag** and press  to select this option.
- ▶ Scroll with  to the desired name in the contacts and press  to select it.
- ▶ Scroll with  to the desired number for which you wish to record the voice tag and press  to select it.
- ▶ Press  again and you will be prompted to speak the voice tag you have selected for this entry.
- ▶ To do so, follow the instructions shown on the display.

Voice tag list

You can use this option to check all of the voice tags saved in your car kit phone memory and to edit the list:

- ▶ To edit the list of voice tags, select the **Voice** menu in the standby display and press  to open it.
- ▶ Scroll with  to the item **Voice tags** and press  to select it.
- ▶ Scroll with  to **List of voice tags** and press  to select this option.
- ▶ Scroll with  to the desired name in the contacts which you wish to edit and press  to select it.
- ▶ Scroll with  to the desired option and press  to select it.

▶ Follow the instructions shown on the display.

- **Play**

This option will play back the voice tag as recorded.

- **Change**

You can replace any voice tag by a new one. Select this option and say the new voice tag.

- **Delete voice tag?**

Select this option to erase a voice tag and make room in the memory for a new voice tag.

Voice dial a number



To voice dial a number:

- ▶ Press . The message **Speak now** will appear on the display.
- ▶ Say the voice tag belonging to the desired number loudly and clearly.

Your car kit phone will play back the voice tag and automatically dial the number assigned to it 1.5 seconds later.

- ▶ To cancel voice dialling, press .

! If you are using a compatible headset with Bluetooth technology, press the key on the headset to activate it before speaking the voice tag.

! When an application using the GPRS connection is sending or receiving data, you cannot make a call using voice dialling. To make a call using a voice tag, you must first end the application using the GPRS connection.

Voice commands

You have a selection of phone functions which can be activated by saying a voice command. A voice tag may be assigned to as many as three of the commands on the list. You can activate the voice command in the same way as making a call using a name tag. Three functions are available:

- **Play**

This option lets you play back selected recordings. The last made recording will be played back first. Press  while listening to a recording to skip it and go to the next one.

- **Download contacts**









You can use this feature to copy contact entries from a compatible mobile which supports Bluetooth wireless technology or from the SIM card installed in the compatible mobile phone to the car kit phone memory. If a wireless Bluetooth SIM Access Profile link has been established, the contact entries stored on the compatible mobile phone will automatically be downloaded.

- **Conn. to Bluetooth headset**

This option allows you to establish a wireless link to a compatible paired headset which supports Bluetooth technology. The option [Search for audio accessories](#) can be used to call the list of active or paired devices. For further information, see "Searching for accessories with Bluetooth technology" on page 51.

Recording voice commands



This option allows you to record a voice command (one or more words acting as a spoken command) and assign it to a function in the list of voice commands.

- ▶ With the display in standby, scroll with  to the **Voice** menu and press  to open it.
- ▶ Scroll with  to the item **Voice commands** and press  to select it.
- ▶ Scroll with  to the **New voice command** and press  to view the list.
- ▶ Scroll with  to the desired function for which you wish to record a voice command and press  to select it.
- ▶ Press  again and you will be prompted to speak the voice tag you have selected for this entry.
- ▶ Follow the instructions shown on the display.

The voice command list includes the phone functions listed for voice commands. Each function on the list can be checked and edited using the options below:

- **Play voice commands**
This option will play back the voice command as recorded.
- **Change**
You can record a new voice command for a selected entry, replacing the existing one.
- **Delete voice command?**
Select this option to erase a voice command and make room in the memory for a new one.

You can use a shortcut to access the list of voice commands direct from the standby display:

- ▶ Press  and scroll left with  .
- ▶ You can now view the list of [Voice commands](#).
- ▶ Follow the instructions shown on the display.

Executing a voice command

- ! When an application using the GPRS connection is sending or receiving data, you cannot execute a voice command. To do so, you must first end the application using the GPRS connection.



To execute a voice command,

- ▶ Press  .
The message [Speak now](#) will appear on the display.
- ▶ Say the voice command loudly and clearly.

Your car kit phone will play back the voice command and automatically perform the function assigned to it 1.5 seconds later.

Recorder



The tape recorder feature allows you to record pieces of speech, sounds or an active phone call. This is especially useful if you need to note information during a

call: for example, you can record a name or a number to be written down later.

- ! Obey all local laws governing recording of calls. Do not use this feature illegally.

You can make up to 10 recordings as long as you do not exceed an overall recording time of five minutes. Each recording is saved together with the running number, the length and time of the call.

New recordings are automatically saved in the memory. When the memory is full, the message [No memory to save rec.](#) will be shown on the display. To be able to make new tape recordings, you will first have to erase some old ones.





- ▶ Press and hold  to begin recording during a phone call.

- ▶ You can easily play back your recordings using a voice command. Say the voice command and your car kit phone will begin with the recording last made. With  you can skip to the next recording.
- ▶ Before you can use this shortcut, you will have to assign a voice command to this function in your car kit phone. For further information, see "Voice commands" on page 48.



Record

This option allows pieces of speech to be recorded and automatically saves the recording.



To make a recording, with the display in standby:

- ▶ Scroll with  to the **Recorder** menu and press  to open it.
- ▶ Scroll with  to **Record** and press  to select this option.
- ▶ Follow the instructions shown on the display.

If you are engaged in an active call and wish to make a recording:

- ▶ Press and hold  to start recording.
- ▶ To end the recording, press .

All tape recordings are stored and numbered (e.g. tape 1). To view the list of recordings, with the display in standby:

- ▶ Select the **Recorder** menu and press  to open it.
- ▶ Scroll with  to the desired recording and press  to select it.

Two options are available for the recordings: **Play** and **Delete**.

- ▶ Scroll to the desired option and press  to select it.
- ▶ Follow the instructions shown on the display.

Play

You can play back a selected recording.

Delete

You can use this option to erase a recording in order to make room for new tapes.

Bluetooth wireless technology



Bluetooth wireless technology is an international standard for wireless short-range communication, allowing you to establish a wireless connection between your car kit phone and a compatible device supporting Bluetooth wireless technology. Such devices may include, for example, mobile phone, a laptop computer or a wireless headset.

Since devices with Bluetooth technology communicate using radio waves, your car kit phone and the other device do not need to be in direct line-of-sight. The two devices only need to be within a maximum of 10 metres of each other, although the connection can be subject to interference from obstructions such as the car body or from other electronic devices.

The car kit phone supports Bluetooth SIM Access Profile technology for wireless access to the remote SIM card of a compatible mobile phone and the Bluetooth headset feature for wireless connection of a compatible headset.

i If you wish to use this function, make sure that both the car kit phone and the other device supporting Bluetooth technology are switched on. There may be restrictions on using such devices in some countries. Check with your local authorities. The connection via Bluetooth wireless technology is not subject to separate charges.





Activating and deactivating Bluetooth

The Bluetooth function is always activated in your car kit phone. However, in other devices with Bluetooth technology, e.g. mobile phones, Bluetooth may have to be activated or deactivated in the device. Make sure that Bluetooth is active in all devices supporting Bluetooth wireless technology that you wish to use with your car kit phone.

For further information, see the user's guide applicable for the device with Bluetooth technology that you are using.

Searching for accessories with Bluetooth technology

This feature allows you to search for accessories which support Bluetooth wireless technology, e.g. a cordless headset with Bluetooth technology in your car:

- ▶ To begin searching, with the display in standby, scroll with  to the **Bluetooth** menu and press  to open it.
- ▶ Scroll with  to **Search for audio enhancem.** and press  to select this option.

The car kit phone will now begin to search for accessories supporting Bluetooth wireless technology. Devices responding to this interrogation will be shown on a list, with the device found last listed at the bottom.

- ▶ Scroll with  through the list.

! A wireless headset with Bluetooth technology can only be found by the car kit phone if there is no active Bluetooth wireless connection from the wireless headset to another compatible device supporting Bluetooth technology. There-

fore, to switch over to a wireless headset with Bluetooth technology, you may need to break an existing Bluetooth wireless connection, for example, to a mobile phone.

- For further information on searching for devices with Bluetooth technology, see "Download contacts" on page 56 and "User settings" on page 58.

If you wish to start Bluetooth pairing with a selected device supporting Bluetooth technology:

- ▶ Press .

Pairing using a Bluetooth passcode

To create a connection using Bluetooth wireless technology, you will need to exchange Bluetooth passcodes with the device you are connecting to for the first time. This operation is called pairing. The Bluetooth passcode is a 1- to 16-character-long numeric code.

If the devices have been successfully paired, you will not need to repeat this procedure when establishing further Bluetooth wireless connections between the devices. Some devices come with a fixed Bluetooth passcode that is supplied with the device. Please refer to the user's guide that is applicable for the accessory that you are using. When prompted by the car kit phone, enter this passcode.





If a fixed passcode is not supplied with a device with Bluetooth technology (e.g. a mobile phone) or the passcode prompt does not appear on the car kit phone display, you can make up a suitable passcode. When prompted, enter this passcode into the two devices sharing a Bluetooth connection. Then follow the instructions shown on the displays of the two devices.

If the car kit phone has found a compatible mobile phone which supports the Bluetooth SIM Access Profile standard, you will be prompted to enter a special Bluetooth passcode. In this case, the car kit phone will show a randomly chosen 16-character-long numeric code on the display, which you now have to key into the compatible mobile phone to be paired with the car kit phone. Note that you will have to be prepared to do this quickly. This passcode is used only once and you do not have to memorise it.

- i** The wireless connection using Bluetooth SIM Access Profile technology meets the high security requirements demanded for Bluetooth technology. For this reason, use of a 16-character-long numeric code is mandatory when two devices are to be paired with Bluetooth SIM Access Profile technology.
- i** If the compatible mobile phone supporting Bluetooth SIM Access Profile technology should itself generate a random 16-character-long numeric passcode, you can use this passcode if desired. To do so, within 3 seconds delete the Bluetooth passcode on the car kit phone display by pressing  and then enter the 16-character-long numeric code from the mobile phone into the car kit phone using the Navi wheel number editor.

View active devices with Bluetooth technology









To show the currently active devices with Bluetooth technology that are sharing a connection with your car kit phone, with the display in standby:

- ▶ Scroll with  to the **Bluetooth** menu and press  to open it.
- ▶ Scroll with  to **View active devices** and press  to select this option.

If desired, you can end an existing Bluetooth wireless connection between two devices in this menu.

View paired devices

You can view a list of Bluetooth wireless technology paired devices by selecting this option. Some of the options below may be available depending on the status of the device or the connection:

- ▶ To view the list of paired devices, with the display in standby, scroll with  to the **Bluetooth** menu and press  to open it.
- ▶ Scroll with  to **View paired devices** and press  to select this option.
- ▶ The list of paired devices will be shown on the display. Scroll with  to the desired compatible device and press  to select it.
- ▶ Scroll with  to the desired option and press  to select it.
- ▶ Follow the instructions shown on the display.

! Note that the latest pairing will be listed at the top.

Create connection

This option establishes a wireless connection to a paired device with Bluetooth technology.

Delete pairing











Select this option to remove a device from the list of paired devices with Bluetooth technology.

Request authorisation





You can define whether the connection from the paired device is to be established automatically (**No**) or whether the car kit phone is to ask for authorisation before pairing (**Yes**) when the device to be paired comes within Bluetooth range of the car kit phone.

Edit Bluetooth name

Select this option to change the name of the device with Bluetooth technology which is paired with your car kit phone. Use the Navi wheel text editor to make the desired changes.







- ▶ To view the list of paired devices, with the display in standby, scroll with  to the **Bluetooth** menu and press  to open it.
- ▶ Scroll with  to **View paired devices** and press  to select this option.
- ▶ The list of paired devices will be shown on the display. Scroll with  to the desired compatible device and press  to select it.
- ▶ Scroll with  to **Bluetooth name** and press  to select this option.
- ▶ The name of the device selected will appear on the display. Press  to confirm the selection.
- ▶ The message **Edit Bluetooth name?** is shown on the display.
- ▶ Scroll with  to the desired option **Yes** or **No** and press  to select it.

If you have selected **Yes**, the Bluetooth name currently in use will be displayed.

- ▶ To delete characters in the name, press .
- ▶ Use the Navi wheel text editor and scroll with  to select the desired characters and press  to enter them.
- ▶ When you have finished entering the desired name, press  to save it.
- ▶ The message **Entry completed?** will appear on the display. Press  to confirm.

The car kit phone's Bluetooth name

Use this option to change your car kit phone's Bluetooth device name, which is shown to others. The factory setting is Nokia 610.







- ▶ To view the name of the car kit phone scroll with  to the **Bluetooth** menu and press  to open it.
- ▶ Scroll with  to **Bluetooth name** and press  to select this option.
- ▶ The name of the car kit phone will appear on the display. Press  to confirm the selection.
- ▶ The message **Edit Bluetooth name?** is shown on the display.
- ▶ Scroll with  to the desired option **Yes** or **No** and press  to select it.
- ▶ Use the Navi wheel text editor to change the Bluetooth name of the car kit phone as desired.

Car kit phone visibility

In order to be able to establish a Bluetooth wireless connection between two compatible devices with Bluetooth technology, the visibility of the Bluetooth devices must first be activated.

- Make sure that the Bluetooth function is activated in all compatible devices with Bluetooth technology to be used and that the visibility has been set to "Shown to all". For further information, see the user's guide applicable for the compatible device with Bluetooth technology that you are using.







You can activate or deactivate the visibility of the car kit phone. The factory setting is on.

- ▶ To change the visibility of your car kit phone, with the display in standby, scroll with  to the **Bluetooth** menu and press  to open it.
- ▶ Scroll with  to **Visibility** and press  to select this option.
- ▶ Scroll with  to the desired option **On** or **Off** and press  to select it.

- Even if your car kit phone's visibility has been activated, it will not be visible for other Bluetooth devices if it is part of an existing Bluetooth wireless connection. To make your car kit phone visible while it is engaged in an existing Bluetooth wireless connection, select the option **Allow second connection**.

Second Bluetooth connection

This setting is required if your car kit phone is to be visible for other devices with Bluetooth technology while it is being used in an existing Bluetooth SIM Access Profile wireless connection to a compatible mobile phone. This feature interrupts the existing Bluetooth SIM Access Profile wireless link for a short time so that, during this interval, other devices with Bluetooth technology (e.g. a laptop) can request a wireless connection via Bluetooth technology, before the car kit phone then automatically re-establishes the Bluetooth SIM Access Profile connection to the compatible mobile phone.

- i** When this setting is selected, the car kit phone will be visible for other Bluetooth devices for a period of time of 30 seconds before the original Bluetooth wireless connection is re-established.
- i** When your car kit phone is not connected to a compatible device using Bluetooth wireless technology, its visibility for other Bluetooth devices depends on the setting made in the **Visibility** menu. In this case, it is not necessary to select the second Bluetooth connection option, for example, in order to establish a wireless connection from a device such as a laptop with Bluetooth technology to the car kit phone.
 - ▶ To access this option, with the display in standby, scroll with  to the **Bluetooth** menu and press  to open it.
 - ▶ Scroll with  to **Allow second connection** and press  to select this option.
 - ▶ Scroll with  to the desired option **Yes** or **No** and press  to select it.

User data





The car kit phone can store and administrate data or settings under two different user data profiles. A user profile, for example, includes contact entries, name tags and voice commands or car kit phone settings. Now two users sharing the car can access their personalised user data using the same SIM card simply by activating their personal user profile.

- i** The indicator for the currently active user profile is shown in the status row of the display. If user profile 1 is active, a small black phone icon is shown; user profile 2 is indicated by a small white phone icon if active. One of the user profiles is active in the car kit phone at all times. When the car kit phone is put into service for the first time, user profile 1 is active.

Download contacts



You can use this feature to copy contact entries from the car SIM card inserted in the car kit phone or from a compatible mobile phone supporting Bluetooth wireless technology to the car kit phone memory.

- i** This feature is important because you do not have direct access to the contact entries stored on a car SIM card inserted in the car kit phone. To access these numbers, you first need to copy them into the car kit phone memory. Follow the instructions shown on the display.
 - ▶ With the display in standby, press  to access these settings.



- ▶ Scroll with  to the **User data** menu and press  to open it.
- ▶ Scroll with  to **Download contacts** and press  to select this option.

If you are operating your car kit phone using a remote SIM card, the contacts stored in the compatible mobile phone will be copied direct to the car kit phone. For further information, see "User settings" on page 58.

If you are operating your car kit phone using the car SIM card inserted in the radio unit, three options will be available for selection: **View paired devices**, **Car SIM card** and **Search for Bluetooth devs..**

- ▶ Scroll with  to the desired option and press  to select it.

Paired devices with Bluetooth technology



- ▶ Scroll with  to the compatible mobile phone with Bluetooth technology (name will be displayed in the list of paired devices) whose contacts you wish to download via the wireless Bluetooth connection to the car kit phone memory.
- ▶ Press  to begin copying the entries.

- i** If you use Bluetooth technology functions regularly, you can deactivate the option "Authorisation request" in the compatible mobile phone. Then connections between the devices via Bluetooth wireless technology can conveniently be made automatically without separate acceptance or authorisation. To do so, scroll to the menu item **View paired devices** and select the option **Request authorisation** and set it to **Off**. For further information, see the user's guide applicable for the compatible mobile phone with Bluetooth technology that you are using.

Car SIM card

- ▶ Press  to copy the contacts from the car SIM card inserted in the radio unit to the car kit phone memory.

Searching for devices that support Bluetooth technology





- ▶ Scroll with  to the option **Search for Bluetooth devs.** and press  to select it, if you wish to carry out the download from a device that has not yet been paired with the car kit phone.

Change user

You may save two user profiles in your car kit phone to be used as desired. The settings for each user profile may be customised to suit the particular needs of the user. The currently active profile is shown on the display at all times using two indicators:

 User 1

 User 2

- ▶ With the display in standby, press  to access the menu.
- ▶ Scroll with  to the **User data** menu and press  to open it.
- ▶ Scroll with  to the option **Change to user 1** or **Change to user 2** and press  to select it.
- ▶ The user profile selected will be activated.





You may be prompted to enter the PIN code belonging to the remote SIM card.

i You may change whether the PIN code of the remote SIM card is to be saved at any time desired by selecting the menu item **Assign SIM card**. For further information, see "Assign SIM card" on page 58.



! If you should change the PIN code of the remote SIM card in the mobile phone at a later time, the wrong PIN code of the remote SIM card will be used the next time you switch on the car kit phone if this option has been activated. You will then be prompted by the car kit phone to enter the changed PIN code. Please note that you may only repeat this twice before the SIM card will be blocked.

User settings

This feature lets you make the desired settings for the active user profile and the contacts to be downloaded using Bluetooth wireless technology. A user profile will be personalised as soon as you have assigned a SIM card to it. You may assign either the car SIM card or a remote SIM card as desired.

- ▶ With the display in standby, press  to access the menu.
- ▶ Scroll with  to **User data** and press  to select this item.
- ▶ Scroll with  to **Settings for user 1** or **Settings for user 2** and press  to select this item.



The following options are available for selection: **Assign SIM card**, **View active SIM card** and **Download settings**.

- ▶ Scroll with  to the desired option and press  to select it.

Assign SIM card

i An active user profile always has a SIM card assigned to it. When personalising user profile 1 or 2 for the first time, observe the information set out in "Getting started" on page 19.

To assign a new SIM card to the car kit phone, select one of the following options:

- ▶ Names of paired devices, **Car SIM card** and **Search for Bluetooth devs**.
- ▶ Scroll with  to the desired option and press  to select it.

Names of paired devices

If you select a mobile phone from the list of paired mobile phones, the car kit phone will establish a Bluetooth SIM Access Profile connection to the paired mobile phone and you may be prompted to enter the PIN code belonging to the remote SIM card installed in the paired mobile phone.

The car kit phone will then ask if you wish to save the PIN code you have just entered for a later automatic connection or whether it is to request authorisation the next time a Bluetooth wireless link is to be made.

- If the operating voltage is interrupted, the PIN code of the remote SIM card stored in the car kit phone will be erased from the memory. If you decide to save the PIN code, you should be aware that this is done at your own risk.

Car SIM card

If you select this option, the car SIM card inserted in the radio unit will be assigned to the active user profile. If the feature requesting you to enter the PIN code at power on is active, you will be prompted to enter the PIN of the car SIM card.

- Some service providers may allow you to switch off the prompt requesting you to enter the PIN at power on. Check with your service provider.

Search for Bluetooth phone

Select this option to assign a remote SIM card installed in a compatible mobile phone that has not yet been paired with the car kit phone to the active user profile. The car kit phone will then search only for mobile phones with Bluetooth SIM Access

Profile technology which are in range and will display the related names in the list of Bluetooth devices. Select a device, pair it with the car kit phone and proceed as described in "Names of paired devices" on page 59.

View active SIM card

Select this option to view the name of the compatible mobile phone whose remote SIM card is assigned to the active user profile.

Download settings

You can copy contact data from any compatible mobile phone that supports Bluetooth wireless technology to your car kit phone. Your car kit phone offers you three convenient options:

- [SIM and phone mem.](#)
This is the default setting that lets you copy both the contact data from the mobile's SIM card and from the phone memory to the car kit phone memory.
- [SIM memory](#)
Select this option should you wish to download only the contact data from your mobile phone's SIM card to the car kit phone.
- [Phone memory](#)
This option copies the entries stored in the phone memory of your mobile to the car kit phone memory.

8. Receiving and forwarding business cards and calendar items

You can receive or forward data such as business cards or calendar notes from or to a compatible mobile phone either via Bluetooth wireless technology or in the form of a short message.

Receiving a business card or calendar item

If you have received a business card or calendar note via Bluetooth wireless technology or in the form of a short message, you may select any of four options:

- ▶ Press  to view the list of options.

View

This option allows you to view the business card or calendar note received.







Save (for business cards only)

Select this option to save a business card in the car kit phone memory. If a wireless Bluetooth SIM Access Profile link has been established to a compatible mobile phone, the business card will automatically be forwarded to the compatible mobile phone.

Forward

You can forward a business card or calendar note that you have received to a compatible device using Bluetooth wireless technology or as a short message.

To forward a business card or calendar note:

- ▶ Press  to confirm receipt of the message.
- ▶ Scroll with  to **Forward** and press  to select this option.
- ▶ Scroll with  to the desired transmission technology **via Bluetooth** or **Via text message** and press  to select it.
- ▶ Scroll with  to the compatible device which you wish to send the message to and press  to select it.

Save and Forward (for business card only)

Select this option to save a received business card in the car kit phone memory and to forward it simultaneously to a compatible mobile device using Bluetooth wireless technology or as a short message. For further information see "Forward" on page 61.

Discard

Select this option if you do not wish to save a business card or calendar note.

9. Data transmission

GPRS (General Packet Radio Service)

GPRS is a technology that allows the car kit phone to be used for sending and receiving data over the mobile network (network service). GPRS as such is a data bearer that enables wireless access to data networks such as the Internet.

Before you can use GPRS technology, you will need to subscribe to the GPRS service. For details on the availability of and subscription to the GPRS service, contact your network operator or service provider.

For further information, see "GPRS modem settings (network service)" on page 42.

HSCSD (High Speed Circuit Switched Data)

The car kit phone enables you to use GSM high-speed data services (network service).

You can use high-speed functionality when your car kit phone is connected to a compatible computer via Bluetooth wireless technology and when the modem drivers supporting high-speed data software are installed on the computer and selected as an active modem. Modem driver software and installation help can be found at the Nokia website: <http://www.nokia.com>.

For information on the availability of and subscription to high-speed data services, please contact your network operator or service provider.

Reference information

- ! Remember that the safety of operating a motor vehicle in traffic requires the full attention of all motorists. Only use the data transmission features offered by your car kit phone if traffic conditions permit safe use, and check if local laws/regulations restrict the use of mobile phones while driving.

Cellular transmission

Your car kit phone employs the data transmission capabilities of the GSM network to send faxes, short messages, and e-mails and to establish connections with remote computers (network services).

GSM data capabilities of your car kit phone

We recommend that you move the car to a location where the strongest possible cellular signal can be obtained. A stronger signal allows more efficient data transmission.

Cellular data communications are subject to a number of factors that may cause interference:

Noise

Radio interference from electronic equipment and devices or from surrounding traffic may impact the transmission quality.

Handovers

As the car kit phone user moves from one network cell to another, the signal strength of the channel drops and the cellular telephone exchange may hand the user over to a different cell and frequency where the signal is stronger. A cell

handover may also occur when the user is stationary due to varying cellular traffic loads. Such handovers may cause delays.

Dead spots and dropouts

Dead spots are areas where radio signals cannot be received. Dropouts occur when the car kit phone user passes through an area where the radio signal is blocked or reduced by geographic or man-made obstructions such as hills or high buildings. The consequences may be interruptions in service or the connection may fail.

Low signal strength

Due to either distance from a base station or obstacles between your car kit phone and the base station, the radio signal strength from a cell site may not be strong or stable enough to provide a reliable cellular connection for trouble-free reception or transmission. Therefore, to ensure the best possible communication, remember to take the following points into consideration when using your car kit phone:

Data and fax transmission will work best when the car is stationary as this ensures that the signal strength will remain constant. Attempting cellular communication while in a moving vehicle is not recommended. Fax transmission is more easily impaired than data or short message transmission.

Check the signal strength on your car kit phone display. If the cellular signals are not strong enough to support a voice call, data connection should not be attempted until you can find a location with better reception.

10. Installation

Your Nokia 610 car kit phone

The Nokia 610 car kit phone is designed for installation in motor vehicles. The sales package contains a convenient handsfree feature which allows you to make calls without holding the phone to your ear, a separate input device for ease of use and an easy-to-read display.

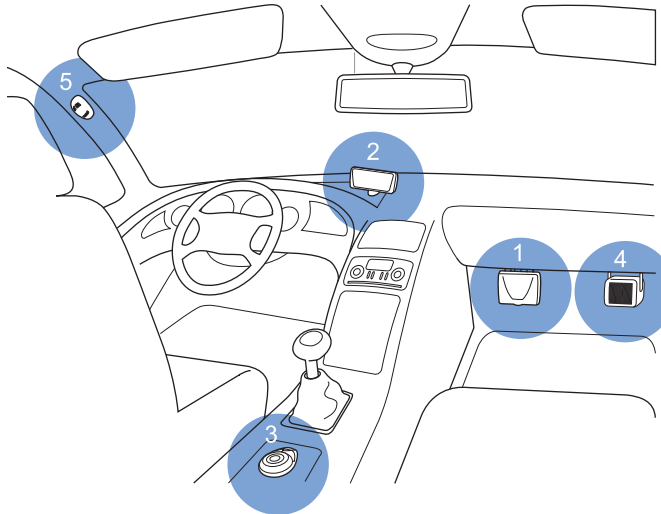

Car kit phone equipment installation in the cockpit

! The Nokia 610 car kit phone may only be installed by a qualified service technician using the approved original Nokia parts supplied in the sales package. Please note that non-observance of this requirement will result in loss of warranty. End users should remember that the car kit phone comprises complex technical equipment that requires professional installation using special tools and expert know-how.

! Note that the instructions contained in this installation guide are general guidelines which apply for the installation of the car kit phone in an automobile. However, due to the wide variety of car types and models available on the market, this guide cannot consider the individual technical requirements relevant for any particular vehicle. Contact the vehicle manufacturer for further detailed information about the vehicle in question. For information on installation locations for the car kit phone equipment, visit the Nokia website at <http://www.nokia.com>.

For important safety information and/or instructions on the operation, care and maintenance of your car kit phone, see "Important safety information" on page 70 and "Care and maintenance" on page 69.

Safety first

- █ The basic safety guidelines set out below are to be observed when installing the car kit phone.
- Make sure that the car ignition is off and disconnect the car battery before beginning with the installation work and ensure that it cannot be reconnected inadvertently.
- Do not smoke when working on the car. Make sure that there is no source of fire or flame nearby.
- Take care not to cause damage to electrical cables, fuel or brake lines or safety equipment during installation work.
- Make sure not to impact the steering or braking systems or other key systems essential for proper operation of the car when installing car kit phone equipment. Check to make sure that deployment of the airbag is not blocked or impaired in any way.
- RF signals may affect improperly installed or inadequately shielded electronic systems in motor vehicles (e.g. electronic fuel injection systems, electronic anti-skid braking systems, electronic speed control systems, airbag systems). Should you note a fault or change in the operation of such a system, contact your car dealer.
- The car kit phone may only be used at an operating voltage of 12 V with the minus pole earthed. Failure to observe this requirement may result in damage to the car's electronics system.
- Do not operate your car kit phone off the car battery for a longer period of time, i.e. with the engine switched off, as this may cause your battery to run dry.

- In order to comply with RF exposure requirements for mobile transmitting devices, a minimum separation distance of 20 cm must be maintained between the antenna and all persons.

Mounting

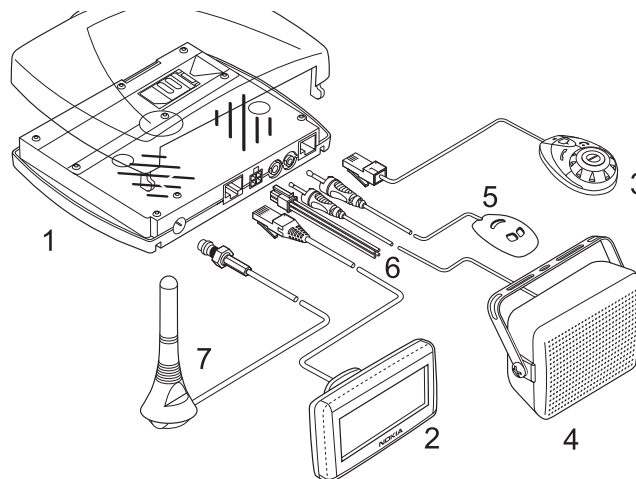

Nokia 610 car kit phone

Radio unit TFE-4 (Pos.1)

We recommend that you mount the radio unit TFE-4 at a less visible position in the car interior. However, ensure that the unit is installed to permit easy access to the SIM card so that it can

be changed if necessary and make sure that the cables for the microphone and loudspeaker will reach the places you intend to mount these components.

When mounting the radio unit, use the bracket which is included in the scope of supply: the unit will clip securely onto the bracket if mounted correctly.

- ! Make sure to mount the radio unit in such a way that a connection using Bluetooth technology can be established to a compatible device.
- ! When installing the radio unit, make sure to mount the bracket in such a way that the unit slides into place towards the front of the car or is mounted sideways. Otherwise the unit may break loose if you have an accident and cause injury or damage.

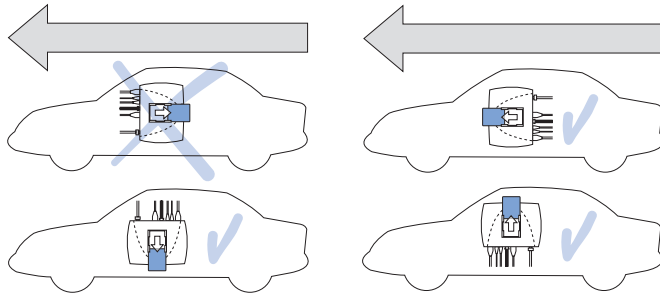

How to mount the radio unit in the car

Display SU-11 (Pos.2)

The mount for the display unit is to be fixed to the dashboard or to any other location in the cockpit area where the display is clearly visible for the user but does not impair control or operation of the vehicle.

Your service technician may be able to provide you with information on alternatives for mounting the display unit suitably in your vehicle without requiring boreholes. You will find further information on suitable mounting locations at the Nokia website <http://www.nokia.com>.

Remember that all equipment must be mounted so that it does not interfere with the operation of the vehicle.

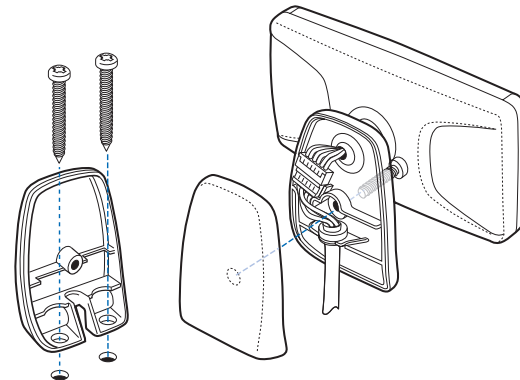

How to mount the display

Input device CUW-3 (Pos.3)

The input device comes with a mount that is to be fixed in a suitable location where it is easily accessible for the user. However, take particular care to ensure that the input device will not interfere with the driver's operation of the vehicle. Make sure that the cable will reach to the radio unit for connection. The best location to mount the input device is horizontally on the console between the driver's and front passenger's seats.

Loudspeaker SP-2 (Pos.4)

To ensure good acoustic quality, mount the loudspeaker so that it is pointed in the user's direction. We recommend that you mount the loudspeaker a minimum distance of 1 metre away from the microphone to avoid feedback. The loudspeaker output of the car kit phone is direct current free.

Microphone HFM-8 (Pos.5)

! Use of any other microphone than the microphone supplied with the car kit phone (HFM-8) may impact the transmission quality.

Mount the handsfree microphone approx. 30 cm from the user's head, and position it so that it points towards the user's mouth. Experience has shown that the best locations are near the rearview mirror or to the left of the sun visor. Check to make sure the microphone does not impair control or operation of the vehicle. We recommend that you keep the microphone a minimum distance of 1 metre away from the car kit phone loudspeaker to avoid feedback.

Use the double-sided adhesive tape supplied to fix the microphone as this will prevent noise from the car body being transmitted into the interior. Take care to mount the microphone so that it is not exposed to air streams from the vents. Do not lay the microphone cable in the heating, ventilation or AC system.

If the mute radio cable has been connected, when you accept an incoming call or when an outgoing call is established, the system will automatically mute your car radio and the call will be switched over to the car kit phone loudspeaker.

System cable PCU-4 (Pos.6)

The system cable connects the car kit phone to the car's electronics system. See the wiring diagram for exact instructions.

! When laying the cables, take care to position them so that they are located as far as possible from the electronics systems installed in your car in order to avoid electromagnetic interference.

Ensure that cables are placed so that they will not be subjected to mechanical wear and tear (e.g. not laid under car seats or over sharp edges).





GSM antenna (Pos.7) (not included in the scope of supply)

Your car kit phone is designed to be connected to an external GSM antenna. However, if your car is equipped with a compatible radio/GSM antenna with a frequency separating filter, this may be used instead.

If your car does not come with a GSM antenna, please contact your dealer for information on the best location for mounting and for the relevant installation guidelines.

Equaliser settings

Your car kit phone supports a variety of options for output over a loudspeaker:

- Direct connection to the SP-2 loudspeaker supplied in the sales package.
 - Connection to a compatible car radio loudspeaker over an additional relay that switches audio output over to the loudspeaker (not included in the scope of supply).
 - Connection to the compatible car radio loudspeakers via the line-in input of your car radio. You will need to adjust the audio level suitably if this option is selected.
- ▶ To make the desired settings, select the **Settings** menu.
- ▶ Scroll with  to the item **Equaliser settings** and press  to select it.
- ▶ Scroll with  to the desired option and press  to select it.

Function test

After your car kit phone has been installed, it needs to be checked to ensure that it is working properly. When testing the operation of the equipment, also check that it has been mounted so that it in no way impairs the driver during operation of the vehicle.

- ! To make a wireless connection between your car kit phone and a compatible accessory with Bluetooth technology, ensure that the devices are within the range necessary for Bluetooth transmission. Remember that external devices need to be supplied with sufficient power for this feature (check the battery pack).

Scope of supply

- Radio unit TFE-4
- Display SU-11
- Input device CUW-3
- Loudspeaker SP-2
- Microphone HFM-8
- System cable PCU-4

11. Care and maintenance

Your car kit phone is a product of superior design and craftsmanship and should be treated with care. The suggestions below will help you to fulfil any warranty obligations and to enjoy this product for many years.

- Keep the car kit phone and all its parts and enhancements out of the reach of small children.
- Keep the car kit phone dry. Precipitation, humidity, and all types of liquids or moisture can contain minerals that will corrode electronic circuits.
- Do not use or store the car kit phone in dusty, dirty areas. Its moving parts can be damaged.
- Do not store the car kit phone in hot areas. High temperatures can shorten the life of electronic devices, damage batteries, and warp or melt certain plastics.
- Do not store the car kit phone in cold areas. When it warms up (to its normal temperature), moisture can form inside, which may damage electronic circuit boards.
- Do not attempt to open the car kit phone. Non-expert handling may damage it.
- Do not drop, knock or shake the car kit phone. Rough handling can break internal circuit boards.
- Do not use harsh chemicals, cleaning solvents or strong detergents to clean the car kit phone.
- Do not paint the car kit phone. Paint can clog the moving parts and prevent proper operation.

- Use only an approved antenna. Unauthorised antennas, modifications or attachments could damage the car kit phone and may violate regulations governing radio devices.

All of the above suggestions apply equally to your car kit phone or any enhancement. If any of them is not working properly, take it to your nearest qualified service facility. The personnel there will assist you and, if necessary, arrange for service.

12. Important safety information

Traffic safety

Remember that the safety of operating a motor vehicle in traffic requires the full attention of all motorists. Only use the features offered by your car kit phone if traffic conditions permit safe use.

Remember: road safety always comes first!

Operating environment

Remember to follow any special regulations in force in any area and always switch off your car kit phone whenever it is forbidden to use it, or when it may cause interference or danger.

Electronic devices

Most modern electronic equipment is shielded from radio frequency (RF) signals. However, certain electronic equipment may not be shielded against the RF signals from your car kit phone.

Pacemakers

Pacemaker manufacturers recommend that a minimum separation distance of 20 cm be maintained between the vehicle antenna and a pacemaker to avoid potential interference with the pacemaker. These recommendations are consistent with the independent research by and recommendations of Wireless Technology Research.

If you have any reason to suspect that interference is taking place, switch your car kit phone over to off mode immediately.

Potentially explosive atmospheres

Switch your car kit phone over to off mode, see "Off mode" on page 22, when in any area with a potentially explosive atmosphere and obey all signs and instructions. Sparks in such areas could cause an explosion or fire resulting in bodily injury or even death.

Users are advised not to use the car kit phone when at a refuelling point. Remember to observe the restrictions on the use of radio equipment in fuel depots (fuel storage and distribution areas), chemical plants or where blasting operations are in progress.

Areas with a potentially explosive atmosphere are often, but not always, clearly marked. They include below deck on boats, chemical transfer or storage facilities, vehicles using liquified petroleum gas (such as propane or butane), areas where the air contains chemicals or particles such as grain, dust or metal powders, and any other area where you would normally be advised to turn off your vehicle engine.

Vehicles

Only qualified personnel should service the phone or install the car kit phone in a vehicle. Faulty installation or service may be dangerous and may invalidate any warranty which may apply to the unit.

Check regularly that all wireless phone equipment in your vehicle is mounted and operating properly.

Do not store or carry flammable liquids, gases or explosive materials in the same compartment as the phone, its parts or accessories.

For vehicles equipped with an air bag, remember that an air bag inflates with great force. Do not place objects, including both installed or portable wireless equipment in the area over the air bag or in the air bag deployment area. If in-vehicle wireless equipment is improperly installed and the air bag inflates, serious injury could result.

Failure to observe these instructions may lead to suspension or denial of telephone services to the offender, or legal action or both.

Emergency calls

Emergency calls may not be possible on all wireless phone networks or when certain network services and/or phone features are in use. Check with local service providers.

Caution!





This car kit phone, like any wireless phone, operates using radio signals, wireless and landline networks as well as user-programmed functions. Because of this, connections in all conditions cannot be guaranteed. Therefore, you should never rely solely upon any wireless phone for essential communications (e.g. medical emergencies).

To make an emergency call



If the phone or car ignition is not on, switch it on. Check for adequate signal strength.

Some networks may require that a valid SIM card is properly inserted in the phone.

- ▶ Press and hold  until **Make an emergency call?** is shown on the display. Confirm by pressing .
- ▶ Confirm the security inquiry **Yes** by pressing  or cancel by selecting **No** with  and pressing .

When making an emergency call, remember to give all the necessary information as accurately as possible. Remember that your car kit phone may be the only means of communication at the scene of an accident - do not cut off the call until given permission to do so.

13. Technical data

Battery voltage

12.6 V DC (10.8 – 16 V DC)

Negative potential to ground (GND).

Current consumption

1.5 A maximum (off mode 1 mA)

Transmitting power

EGSM 900: 3.2 mW – 2 W

DCS 1800: 1.0 mW – 1 W

System cable PCU-4

System cable wiring

1. +12V car battery +, red
2. Ground (car battery -), black
3. Car radio mute, yellow
4. Car ignition sense, blue
5. 2A fuse
6. 1A fuse

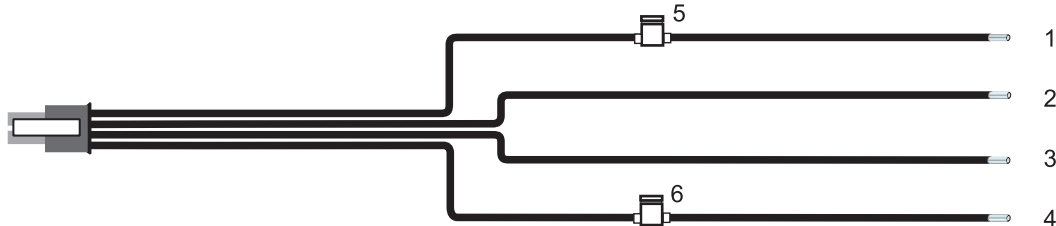

14. Glossary

Bluetooth SIM Access Profile

SIM Access Profile is an international de-facto Bluetooth standard which allows wireless access to the remote SIM card of a compatible mobile phone using Bluetooth technology.

Car SIM card

The car SIM card is inserted in the SIM card reader in the Nokia car kit phone.

DTMF tones

You can use DTMF (Dual Tone Multi-Frequency) tones to communicate with voice mailboxes, computerised telephony systems, etc. The tones can be selected by using the Navi wheel number editor to scroll to the numbers 0-9.

GPRS

GPRS (General Packet Radio Service) enables wireless data transmission. For wireless access to data networks, you will need a GPRS access point from your network operator or service provider. For further information, see "GPRS (General Packet Radio Service)" on page 62.

GSM

GSM, the Global System for Mobile Communication, is the technical standard for mobile radio networks.

HSCSD

HSCSD (High Speed Circuit Switched Data) makes data connections faster for attractive GSM data services. For further information, see "HSCSD (High Speed Circuit Switched Data)" on page 62.

IMEI

The IMEI is the serial number of your device and is supplied with the car kit phone.

PIN code

The PIN (Personal Identification Number) is a 4- to 8-digit code which protects your SIM card from unauthorised use. The PIN code is supplied with the SIM card. For further information, see "Access codes required for the car SIM card" on page 14.

PUK code

The PUK (Personal Unblocking Key) is an 8-digit code which is required to change a disabled PIN code.

The PUK code is supplied with the SIM card. If you lose the code or it has not been provided with the SIM card, contact your network operator.

Remote SIM card

The remote SIM card is inserted in the SIM card reader of the compatible mobile phone connected to the car kit phone over a Bluetooth SIM Access Profile wireless connection.

SIM card

The SIM (Subscriber Identity Module) card contains all the information the cellular network needs to identify the network user. The SIM card also contains security-related data.

SMS

The network service SMS (Short Message Service) allows you to send short text messages (of up to 160 characters) to mobile phones and to receive short text messages from other mobile users if this service is enabled.

SMSC number

The SMSC (Short Message Service Centre) number is needed for sending of short messages.

LIMITED MANUFACTURER'S WARRANTY

PART OF EUROPE & AFRICA REGION

This limited warranty shall apply in part of Nokia Mobile Phones' Europe & Africa Region unless a local warranty exists. Nokia Corporation, Nokia Mobile Phones ("Nokia") warrants that this NOKIA product ("Product") is at the time of its original purchase free of defects in materials, design and workmanship subject to the following terms and conditions:

1. This limited warranty is given to the end-purchaser of the Product ("Customer"). It shall neither exclude nor limit i) any mandatory statutory rights of the Customer or ii) any of the Customer's rights against the seller/dealer of the Product.
2. The warranty period is twelve (12) months from the date on which the first Customer purchased the Product. In case of a subsequent purchase or other change of owner/user, such warranty period shall continue for the remaining part of the twelve (12) month period and otherwise remain unaffected. This limited warranty is only valid and enforceable in the following countries: Bosnia, Bulgaria, Croatia, Cyprus, the Czech Republic, Estonia, any member state of the European Union, Hungary, Iceland, Israel, Latvia, Lithuania, Macedonia, Malta, Norway, Poland, Romania, the Slovak Republic, Slovenia and Switzerland.
3. During the warranty period Nokia or its authorized service company will repair or replace, at Nokia's sole discretion, a defective Product. Nokia will return the repaired Product or another Product to the Customer in good working condition. All parts or other equipment for which replacements have been provided shall become the property of Nokia.
4. A repaired or replaced Product will not be given a prolonged or renewed warranty period.
5. This limited warranty will not cover painted covers or other similar personalized parts. In all cases that require unlocking or locking of an operator SIM-lock, Nokia will first direct the Customer to such operator for unlocking or locking of the operator SIM-lock before repairing or replacing the Product.
6. This limited warranty shall not apply to deterioration due to normal wear and tear. This limited warranty shall further not apply if:

(i) the defect was caused by the fact that the Product has been subjected to a use in contradiction with the owner's/user manual, rough handling, exposure to moisture, dampness or extreme thermal or environmental conditions or rapid changes in such conditions, corrosion, oxidation, unauthorized modifications or connections, unauthorized opening or repair, repair by use of unauthorized spare parts, misuse, improper installation, accident, forces of nature, spillage of food or liquid, influence from chemical products or other acts beyond the reasonable control of Nokia (including but not limited to deficiencies in consumable parts, such as batteries which all by their nature have a limited lifetime, and breakage or damage to antennas) unless the defect was caused directly by defects in materials, design or workmanship;

(ii) Nokia or its authorized service company was not notified by the Customer of the defect within thirty (30) days after the appearance of the defect within the warranty period;

(iii) the Product was not returned to Nokia or its authorized service company within thirty (30) days after the appearance of the defect within the warranty period;

(iv) the Product serial number, the accessory date code or the IMEI number has been removed, erased, defaced, altered or is illegible;

(v) the defect was caused by a defective function of the cellular network;

(vi) the defect was caused by the fact that the Product was used with or connected to an accessory not manufactured and supplied by Nokia or used in other than its intended use;

(vii) the defect was caused by the fact that the battery was short-circuited or seals of the battery enclosure or cells were broken or show evidence of tampering or the battery was used in equipment other than for which it has been specified; or

(viii) the Product software needs to be upgraded due to changes in cellular network parameters.

7. To claim this limited warranty the Customer shall present either i) a legible and non-modified original warranty card which clearly indicates the name and address of the seller, the date and place of purchase, the product type and the IMEI or other serial number or alternatively ii) a legible and non-modified original purchase receipt which contains the same information, if such purchase receipt is presented to the seller/dealer of the Product.

8. This limited warranty is the Customer's sole and exclusive remedy against Nokia and Nokia's sole and exclusive liability against the Customer for defects or malfunctions of the Product. This limited warranty replaces all other warranties and liabilities, whether oral, written, (non-mandatory) statutory, contractual, in tort or otherwise. Nokia is in no event liable for any incidental, consequential or indirect damage, costs or expenses. Neither is Nokia in any event liable for any direct damage, costs or expenses, if the Customer is a legal person.

9. Any change or amendment to this limited warranty requires Nokia's prior written consent.

WARRANTY CARD

FILL IN WITH BLOCK LETTERS

Purchaser's Name: _____

Address: _____

Country: _____

Phone: _____

Date of Purchase (dd/mm/yy): / /

Product Type (on phone type label under battery): -

Product Model (on phone type label under battery):

Phone Serial No (on phone type label under battery):

/ /

Place of Purchase: _____

Store Name: _____

Store Address: _____



ITEM:
IMEI:

B

Stamp