

Miele

TOUCHTRONIC 



Operating and Installation Instructions Washer W 3035

To prevent accidents and
appliance damage,
read these instructions

before
installation or use.

en - US, CA

M.-Nr. 07 017 530

Contents

IMPORTANT SAFETY INSTRUCTIONS	4
Guide to the washer	6
Control panel	6
Display function	7
Before using for the first time	8
Setting the display language	8
Using the washer	9
1. Prepare and sort the laundry	9
2. Turn on the washer	10
3. Load the laundry	10
4. Select a program	11
5. Select a temperature and/or spin speed	11
Program guide	12
Final spin speed	16
5. Select an option	17
7. Add detergent	18
Detergent	21
Fabric care	22
Using the washer	23
8. Select Delay Start (if desired)	23
9. Start the program	23
10. Activate the Child Lock (if desired)	24
11. Program end	24
Canceling a program	25
Interrupting a program	25
Changing a program	25
Preparing your appliance for an extended vacation	26
Adding/removing laundry during a wash program	26
Quick guide	27

Cleaning and care	27
Cleaning the exterior and control panel	27
Cleaning the drum	27
Cleaning the detergent drawer	27
Cleaning the water inlet filters	29
Cleaning the drain pump and lint trap	30
Frequently asked questions	32
A wash program cannot be started	32
The display shows a fault message	33
General problems with the washer	34
Poor wash results	35
The drum door cannot be opened	36
Opening the drum door during a power failure	37
After sales service	38
Installation instructions	39
Installation	40
Front view	40
Rear view	41
Installation site	42
Removing the shipping struts	42
Installing the shipping struts	44
Leveling the washer	45
Plumbing	46
Electrical connection	49
Setting the display language	50
Help protect our environment	51

IMPORTANT SAFETY INSTRUCTIONS

 **WARNING** - To reduce the risk of fire, electric shock or injury to persons while using your appliance follow basic safety precautions, including the following:

▶ Read all instructions before using the appliance.

▶ GROUNDING INSTRUCTIONS

This appliance must be grounded. In the event of a malfunction or breakdown, grounding will reduce the risk of electric shock by providing a path of least resistance for electric current. This appliance is equipped with a cord having an equipment-grounding conductor and a grounding plug. The plug must be plugged into an appropriate outlet that is properly installed and grounded in accordance with all local codes and ordinances.

▶ **WARNING** - Improper connection of the equipment-grounding conductor may result in a risk of electric shock. Check with a qualified electrician if you are in doubt as to whether the appliance is properly grounded.

▶ Do not modify the plug provided with the appliance - if it will not fit the outlet, have a proper outlet installed by a qualified electrician.

▶ Do not install or use a washer with visible damage.

▶ Do not install or store this appliance where it will be exposed to the weather.

▶ Do not install your washing machine where temperatures below freezing may occur. Frozen hoses may burst under pressure. The reliability of the electronic control unit may be impaired at temperatures below freezing.

▶ Before connecting the machine, ensure that the connection data on the data plate (fusing, voltage and frequency) match the mains electrical supply. If in doubt contact an electrician.

▶ Do not use an extension cord to connect this appliance to the power supply. Extension cords do not guarantee the required safety of the appliance (e.g. danger of overheating).

▶ This appliance is not designed for maritime use or for use in mobile installations such as recreational vehicles or aircraft. However, under certain conditions it may be possible for an installation in these applications. Please contact the Miele Technical Service Dept. with specific requirements.

▶ Do not repair or replace any part of the appliance or attempt any servicing unless specifically recommended in these operating instructions.

IMPORTANT SAFETY INSTRUCTIONS

▶ If the power cord is damaged it must only be replaced by a Miele Service technician with a genuine Miele power cord.

▶ Under certain conditions, hydrogen gas may be produced in a hot water system that has not been used for 2 weeks or more. **HYDROGEN GAS IS EXPLOSIVE.** If the hot water system has not been used for such a period, turn on all hot water faucets and let the water flow from each for several minutes before using the washing machine. This will release any built-up hydrogen gas. Do not smoke or use an open flame during this time, the gas is flammable.

▶ Before the appliance is removed for service or discarded, remove the door.

Use

▶ Do not allow children to play on or in the appliance. Close supervision is necessary when the appliance is used near children.

▶ The drum door glass will be hot when washing at very high temperatures. Do not touch the glass. Danger of burns! Keep children away from the washer when in use.

▶ Only use the washing machine to wash items which are specified by the manufacturer to be machine washable on the fabric care label. Any other applications may be dangerous.

▶ Do not wash articles that have been previously cleaned, washed, soaked or spotted with gasoline, dry-cleaning solvents or other flammable substances. These articles give off vapors that could ignite or explode. Do not add these items to the wash load.

▶ Do not add gasoline, dry-cleaning solvents, or other flammable or explosive substances to the wash water. These substances give off vapors which could ignite or explode.

▶ Do not use cleaning solvents on or near the machine or the controls. Contact with cleaning solvents will damage the surface.

▶ Do not reach into the appliance if the drum is moving.

▶ Do not tamper with the controls.

SAVE THESE INSTRUCTIONS

Guide to the washer

Control panel

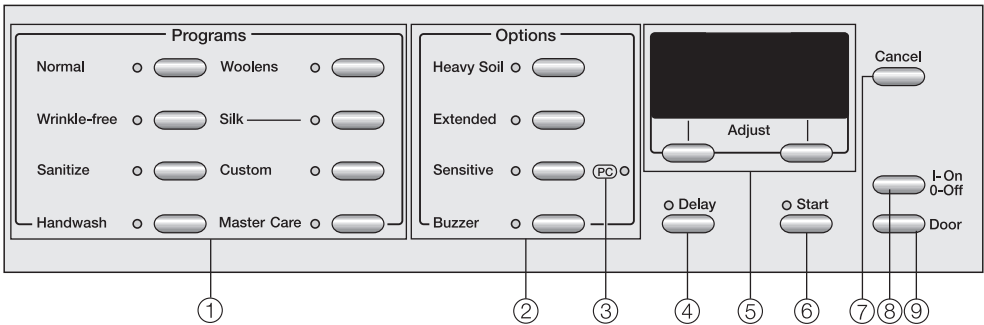

① **Program buttons**

To select a wash program

② **Option buttons**

Special features to enhance a wash program

③ **PC Indicator**

Allows a service technician to check and update the wash programs

④ **"Delay Start" button**

To delay the start of a program

⑤ **Display with "Menu" buttons**

See more information on the following pages

⑥ **"Start" button**

Starts the selected wash program

⑦ **"Cancel" button**

Switches back to the previous menu during program selection or cancels the running program

⑧ **"On/Off" button**

Turns the machine on and off

⑨ **"Door" button**

Opens the drum door

Display function

The display allows you to operate and select various functions of the washer.

Selection and display of program settings

- Temperature selection
- Spin speed selection
- Delay start
- Display of an approximate program running time

Program selection using the display

By pressing the "MasterCare" button, you can select from the following programs:

- Extra White
- Delicates
- Denim / Jeans
- Dress shirts
- Pillows
- Outerwear
- Table linens
- Beach towels
- Express
- Drain / Spin
- Quick rinse

"Menu" buttons

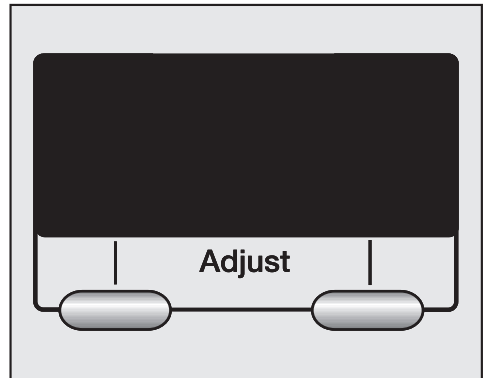

Various settings can be made with the "Menu" buttons.

The values above the vertical line can be adjusted and/or confirmed.

Example:



Pressing the left menu button "**Warm**" allows to adjust the temperature. The "**High spin**" button allows you to adjust the spin speed.

Example:



With the "▼" button additional programs can be selected and confirmed with the "**OK**" button.

Before using for the first time

The appliance must be correctly installed and connected before the first use. Please see the "Installation instructions."

This washing machine has undergone thorough testing in the factory, there may be some residual water in the drum from this process.

Running a spin cycle before the first use is, for safety reasons, not possible. To activate the spin cycle a wash program must be run **without laundry or detergent**.

- Turn on the water supply.

The Welcome screen shows once the washer is turned on for the first time.

The Welcome screen will not show after the washer has run for more than 1 hour.

The display now shows the language setting.

Setting the display language

The default setting for the display language is **German**. The display language can be adjusted.



- Select the desired language by pressing the left menu button "☰". Confirm the setting with the right "OK" button.

Shipping strut reminder

The shipping struts must be removed before the first use to avoid machine damage.

- Confirm that the shipping struts have been removed by pressing "OK".

The washer is now ready for the first use.

Starting the first wash program

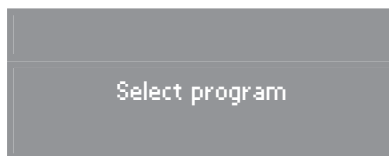

- Press the program button "Sanitize".
- Press the "Start" button.

Once the program has finished the first use is complete. The washer can be used.

1. Prepare and sort the laundry

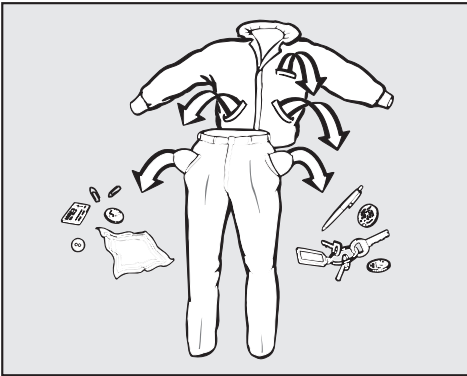

- Empty all pockets.

 Foreign objects left in pockets (e.g. nails, coins, paper clips, etc.) can cause damage to clothes and the machine.

Pre-treat stains

- Tough stains (blood, egg, coffee, tea, etc.) or badly soiled areas (collars and cuffs) should be pre-treated with a stain remover or a paste made from powder detergent and warm water. Dab stains with a damp light colored cloth. Do not rub!

 Do not use chemical solvents in the machine.

Sort the laundry

- Only wash items that are labeled machine washable by the manufacturer. Most garments have a fabric care label in the collar or side seam.
- Sort the laundry by care label and color.

General tips

- Dark fabrics often bleed the first few times they are washed. They should be washed separately several times before being included in a mixed load.
- Curtains: Remove any lead weights or strips before washing.
- Loose bra underwires should be removed or sewn in place before washing.
- Woolens, knitted garments, jeans, pants and sweat shirts should be turned inside out.
- Close zippers, hooks and eyelets before washing.
- Comforter covers and pillowcases should be fastened to prevent small items from rolling inside of them.
- **Do not** wash items with the  symbol on the fabric care label.

Using the washer

2. Turn on the washer

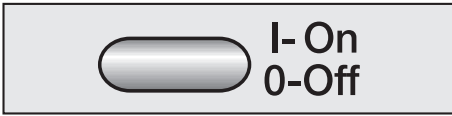

- Press the I-On / 0-Off button. The washer is turned on and the program indicators light.

3. Load the laundry



- Press the "Door" button to open the drum door.
- Load the laundry loosely into the drum. For best results, wash mixed loads of small and large items. This will improve washing effectiveness and help distribute the load evenly.

Water consumption and energy usage are determined by the size of the load.

The washer automatically adjusts the amount of water to conserve water and energy when washing smaller loads. The time remaining will automatically be adjusted to reflect a shorter wash program.

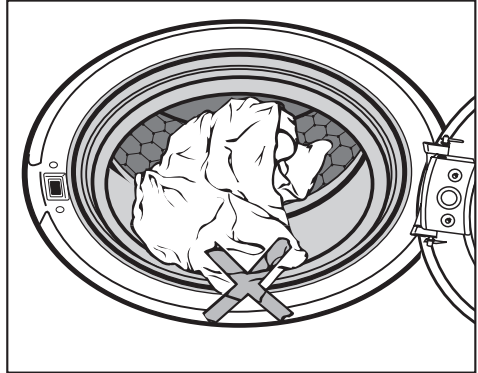

To prevent damage to the door seal and clothing, make sure that there are no clothes caught between the drum door and the seal.

- Close the drum door.

4. Select a program

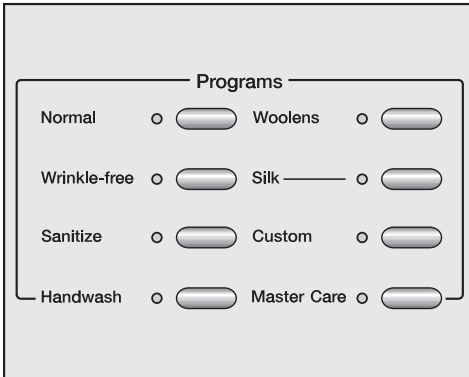

- Press the button of the desired program. See the "Program guide" for information about the programs.

The indicator of the selected program lights.

5. Select a temperature and/or spin speed

The pre-selected temperature and/or spin speed can be adjusted if the program allows so.



- By pressing the left menu button "**Warm**", the temperature can be adjusted. Pressing the "**High spin**" button will adjust the spin speed.

When selecting "MasterCare" the display shows a list.















- With the "▼" button additional programs can be selected and confirmed with the "**OK**" button.



- If desired and allowed by the program, adjust the temperature and spin speed with the menu buttons.











Using the washer

Program guide













Temperature		Final spin	Item / Tip
Normal	Options: Heavy Soil, Extended, Sensitive, Buzzer		
Hot		Max spin	Items made from cottons, linen or mixed fabrics. Important: Fill the drum only $\frac{3}{4}$ of the way. Items need room to move otherwise they might get caught in the drum door seal.
Very Warm			
Warm			
Cold			
No Heat			
Wrinkle free	Options: Heavy Soil, Extended, Sensitive, Buzzer		
Hot		High spin Med spin	Items made from synthetics, mixed fabrics or wrinkle free cottons.
Very Warm			
Warm			
Cold			
No Heat			
Sanitize	Options: Heavy Soil, Extended, Sensitive, Buzzer		
Sanitize		Max spin High spin	Items which have skin contact or for special hygienic requests.
Hot			
Handwash	Options: Heavy Soil, Extended, Sensitive, Buzzer		
Warm		Med spin	Hand washable items which do not contain wool or silk.
Cold			
No Heat			

The default settings are highlighted in **bold**.



Using the washer

Temperature		Final spin	Item / Tip
Woolens			
Options: Sensitive, Buzzer			
Warm		High spin Med spin Slow spin Hold No spin	Items made from washable wool or mixed woolens.
Cold			
No Heat			
Silk			
Options: Buzzer			
Cold		Slow spin	Silk and hand washable items which do not contain wool.
No Heat			
Custom			
Options: Heavy Soil, Extended, Sensitive, Buzzer			
Sanitize		Max spin High spin Med spin Slow spin Hold No spin	All options are selectable for "Sanitize" and "Normal" programs.
Hot			
Very Warm			
Warm			
Cold			
No Heat			
Extra White			
Options: Heavy Soil, Extended, Sensitive, Buzzer			
Hot		Max spin High spin	For white items without special hygienic requests.
Very Warm			

Using the washer

Temperature		Final spin	Item / Tip
Delicates Options: Extended, Sensitive, Buzzer			
Warm		Med spin Slow spin Hold No Spin	For delicate items made from synthetics.
Cold			
No Heat			
Denim / Jeans Options: Heavy Soil, Extended, Sensitive, Buzzer			
Warm		High spin Med spin	All items made from denim. Before washing denim items, turn them inside out.
Cold			
No Heat			
Dress shirts Options: Heavy Soil, Sensitive, Buzzer			
Warm		Med spin Slow spin Hold No Spin	Pretreat collars and cuffs if needed.
Cold			
No Heat			
Pillows Options: Sensitive, Buzzer			
Hot		High spin Med spin Slow spin	Washable pillows with a filling of feathers, down or synthetics. 2 twin or 1 queen size pillow
Very Warm			
Warm			
Outerwear Options: Buzzer			
Cold		Med spin	Close all zippers. Do not use fabric softener.
Table linens Options: Heavy Soil, Extended, Sensitive, Buzzer			
Warm		High spin Med spin Slow spin Hold No Spin	For table cloths and napkins.
Cold			
No Heat			

Using the washer

Temperature		Final spin	Item / Tip
Beach towels Options: Buzzer			
No Heat		Max spin	Program to rinse sand from beach towels. Do not use detergent.
Express Options: Buzzer			
Warm		Max spin High spin Med spin Slow spin Hold No Spin	Small loads of mixed items for the programs "Normal" and "Wrinkle free".
Cold			
No Heat			
Drain / Spin Options: Buzzer			
		Max spin High spin Med spin Slow spin No Spin	
Quick rinse Options: Buzzer			
		High spin Med spin Slow spin Hold No Spin	

Using the washer

Final spin speed

Program	
Normal	Max spin
Wrinkle-free	High spin
Sanitize	Max spin
Handwash	Med spin
Woolens	High spin
Silk	Slow spin
Custom	Max spin
Extra White	Max spin
Delicates	Med spin
Denim/Jeans	High spin
Dress shirts	Med spin
Pillows	High spin
Outerwear	Med spin
Table linens	High spin
Beach towels	Max spin
Express	Max spin
Drain / Spin	Max spin
Quick rinse	High spin

The final spin speed can be reduced, if the program allows changes. The selection of a final spin speed higher than that shown above is not possible.

Rinse spin

The laundry is spun after the main wash and between the rinse cycles. Reducing the final spin speed will also reduce the rinse spin speeds.

Hold

- Select the option "Hold".

The laundry is not spun and remains soaking in water. This will prevent wrinkles if the laundry is not removed immediately at the end of the wash program.

- Selecting the final spin

The washer is set default to the maximum spin speed of the wash program. You can select a lower spin speed.

- Press "Start" to begin the final spin.

- To finish the program

- Press the "Cancel" button. The water will be drained and the program ends.

No spin

(Deselect rinse spin and final spin)

- Select "No spin". The laundry is not spun after the final rinse, but the water is drained away. After the drain cycle the washer goes immediately into the anti-crease cycle.

5. Select an option

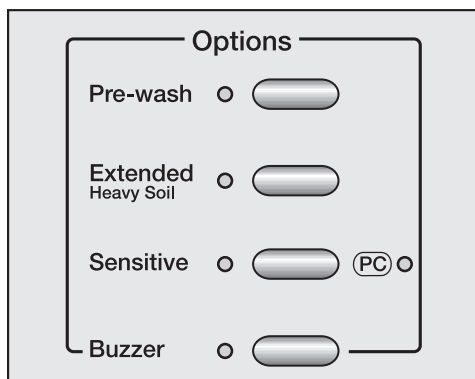

- Select the desired Option with the respective button. Once an Option is selected, the indicator lights.

See the "Program Guide" to determine which Option is selectable for each program.

If an Option cannot be selected, the wash program does not permit it.

Pre-wash

For heavily soiled laundry or stubborn dried on stains.

A pre-wash takes place and the wash time for the main wash is extended.

Extended

For laundry with normal to heavy soiling or stains.

The main wash cycle time for the wash program is extended.

Sensitive

An additional final rinse washes away detergent residue and scents.

An additional rinse takes place.

Buzzer

A buzzer signals the end of the wash program or after "Hold". The buzzer sounds until the washer is turned off. The buzzer volume can be adjusted.

Adjusting the buzzer volume

No program is selected.

- Press the "Buzzer" button until the display shows:



- Press the left menu button "⏪" to adjust the buzzer volume. Confirm with "OK".

Using the washer

7. Add detergent

Front loading washing machines require **special high efficiency detergents**. Closely follow the requirements of the detergent manufacturer.

Use detergent according to the laundry soiling. Use less for smaller loads.

Light soiling

No soiling or stains are visible.

Normal soiling

Some visible soiling or a few light stains.

Heavy soiling

Very visible soiling or stains.

Use the "Heavy soil" function and split the detergent in the Heavy soil compartment as described.

Too little detergent may cause:

- laundry to not be cleaned effectively and become gray and stiff over time.
- grease to not be completely washed from the laundry.
- calcium deposits on the heater.

Too much detergent may cause:

- oversudsing with poor wash, rinse and spin results.
- a higher water usage, because of an extra rinse which is automatically added
- a higher environmental burden.

Using liquid detergent

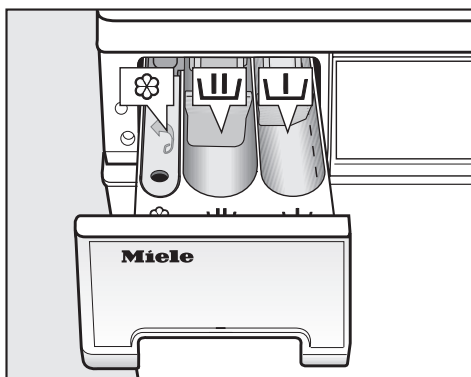

- Pull out the detergent dispenser drawer and add detergent to the compartments.

You can not combine "Heavy soil" and use bleach in the same cycle. The "Heavy soil" function flushes away the bleach prematurely.

- Close the detergent drawer.



Detergent for Heavy Soil

- Only add detergent ($\frac{1}{3}$ of the total amount recommended) to the  compartment, if the "Heavy Soil" option is selected.

OR

Bleach

- Add bleach to compartment  as described by the manufacturer.

- **Do not use** the "Heavy Soil" option.

Once the main wash cycle has finished the bleach will automatically be rinsed from the compartment.

Detergent for the main wash

-  **Fabric softener or liquid starch**

Using the washer

Using powder detergent

Liquid detergent inserts come already inserted in the detergent compartments. To use powder detergent remove the inserts.

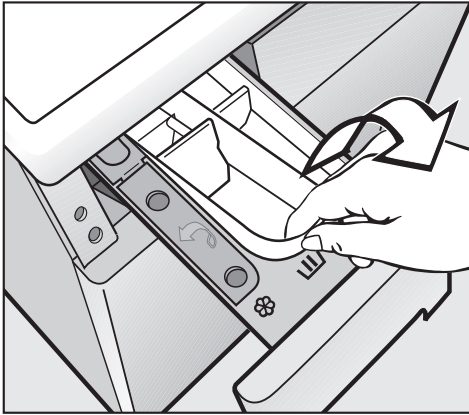

- Remove the inserts from both compartments  and .

Detergent for "Heavy Soil"

- Only add detergent ($\frac{1}{3}$ of the total amount recommended) to the  compartment, if the "Heavy Soil" option is selected.

Since powder detergents already contain bleach, using additional liquid bleach is not recommended.

Detergent for the main wash

-  **Fabric softener or liquid starch**
- Replace the inserts in the compartments before using liquid detergent.

Detergent

You can use all **high efficiency detergents** which are formulated for household washing machines. Closely follow the requirements of the detergent manufacturer.

	Universal	Color	Delicate	Bleach
Normal	X	X		X
Wrinkle-free	X	X		X
Sanitize	X			
Handwash			X	
Woolens	Detergent for wool			
Silk			X	
Custom	X	X		X
Extra White	X			X
Delicates			X	X
Denim / Jeans		X ¹⁾		X
Dress shirts	X	X		X
Pillows	X ¹⁾	X ¹⁾		
Outerwear			X	X
Table linens	X			X
Beach towels	Do not use detergent			
Express	X	X		

¹⁾ only liquid detergent

Fabric care

Fabric softener

Makes fabrics feel softer and reduces static cling in the dryer.

Mild liquid starch

A synthetic starch wash that gives fabrics some stiffness.

Starch

Gives the fabrics stiffness and volume.

Dispensing fabric softener or liquid starch

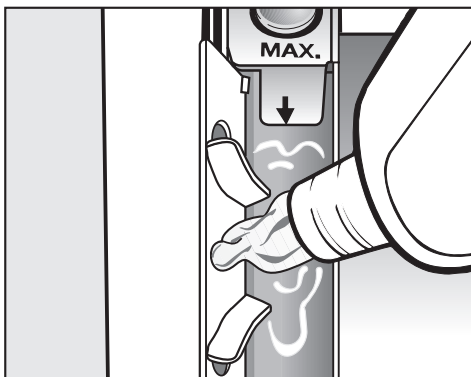

- Add the fabric softener, mild liquid starch or starch to compartment ☼. **Do not exceed the maximum fill level marked inside the compartment.**

The fabric softener / liquid starch will be dispensed during the final rinse. A small amount of water will remain in the compartment at the end of the program ☼.

If starching frequently, clean the dispenser compartment and especially the siphon tube.

Bleach

To remove difficult to clean stains.

Dispensing bleach

The liquid detergent insert must be inserted in compartment ☽. The option "Heavy Soil" **cannot be selected.**

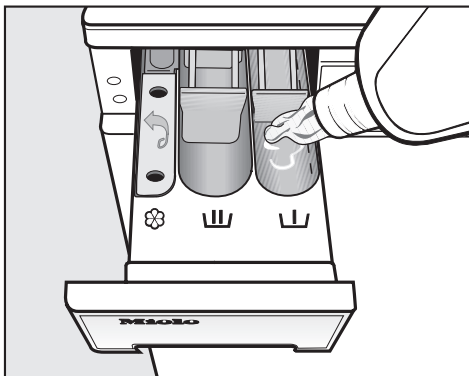

- Pour the bleach into compartment ☽ according to the manufacturer's instructions.

The bleach will be automatically dispensed after the main wash.

Dyes / dye removers

The use of dyes in the washer is recommended only to a degree of usual household use. The salt used for dyeing may corrode the stainless steel with frequent use.

- Use only as directed by the manufacturer.

⚠ Do not use dye removers in this washer!

8. Select Delay Start (if desired)

Delay start allows you to delay the start of a program from 30 minutes up to a maximum of 24 hours.

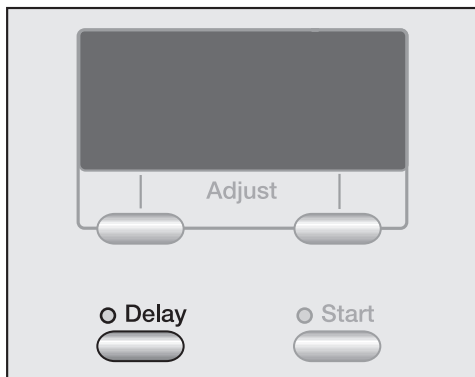

- Press the "Delay" button.



- With every touch of the "Delay" button, the start is delayed longer. Press and hold to speed up the count.
 - For a delay less than 10 hours, the delay time extends in 30 minute increments.
 - For a delay time more than 10 hours, the delay time extends in 1 hour increments.

Cancel

Press the "Cancel" button.

Adjust

To adjust the Delay Start time cancel and reset.

9. Start the program

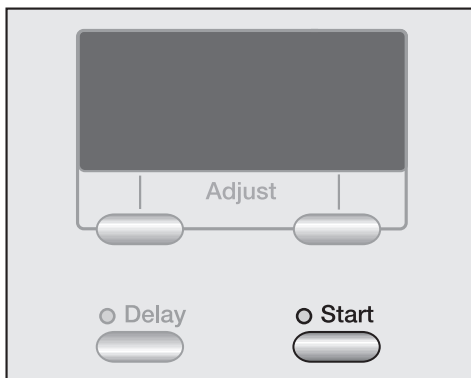

- Press the flashing "Start" button.

If the delay start is set, the remaining times elapses in the display. Once the delayed start time has elapsed or immediately after the program start, the approximate program running time is displayed. The overall program time may be shortened or lengthened.

Additionally the sequence cycle is displayed. The washer shows the current program step.

The drum light turns off once the program starts.

Using the washer

10. Activate the Child Lock (if desired)

The Child Lock can be activated to prevent a child from canceling the program and opening the door at the end of a program.

- Press and hold the "Heavy soil" button until the display shows:



Deactivate the Child Lock

- Press the "Heavy soil" button until the display shows:



Once the program has finished, the Child Lock must be deactivated.

11. Program end

During the "Anti-crease" program the display shows "Anti-crease" alternating with "End".

- Open the drum door and remove the laundry.

Check the drum for any missed pieces of laundry. Items inadvertently left in the washer may be damaged (e.g. shrink or discolor) during the next wash cycle.

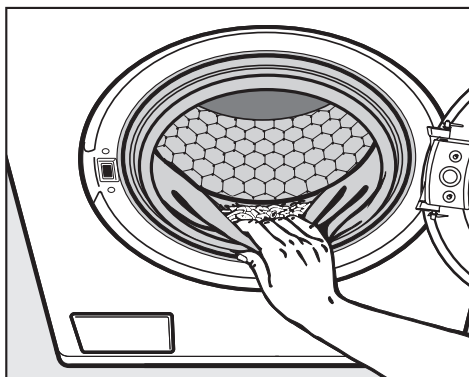

- Check the folds of the door seal for any small articles.
- Close the drum door.
- Activate the Child Lock so children or animals do not find their way into the drum.

Canceling a program

A program can be canceled any time after the program start.

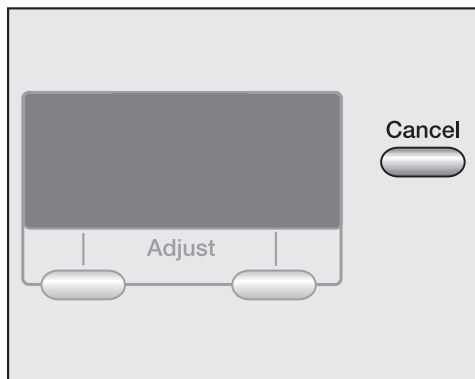

- Press and hold the "Cancel" button until the display shows:

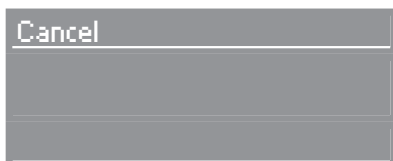

The wash water will be drained away.

To add or remove laundry

- Open the drum door.

To select another program

The display requests the program selection.

- Press the desired program button.

Interrupting a program

- Turn the washer off.

To continue:

- Turn the washer on again.

Changing a program

A program change is not possible once the program has started. The program must be canceled.

Adjusting the temperature

The temperature can be changed up to 6 minutes after the program start.

Adjusting the spin speed

The spin speed can be adjusted anytime until the beginning of the final spin.

Adjusting the options

The options "Extended" or "Sensitive" can be selected or deselected up to 6 minutes after the program start.

The "Buzzer" option can be selected or deselected at any time.

Using the washer

Preparing your appliance for an extended vacation

If you elect to turn off the water to your home for an extended period of time, please note that this may not be enough to reduce the risk of a leak.

To be completely safe, you must turn off the water supply to each individual appliance. This means under the sink for a dishwasher, at the laundry bib for your washer, etc.

Adding/removing laundry during a wash program

- Press and hold the door button until the door opens.
- Add or remove laundry.
- Close the door.

The program continues automatically.

Note:

Once the program has started the washer can not make adjustments of the load size.

The drum door cannot be opened if:

- the water temperature is greater than **130°F (55°C)**.
- the water level is too high.
- the program has reached the "Final Spin".
- The Child Lock function is activated.

If you attempt to open the door while the washer is in one of the above statuses "Machine locked" will appear in the display.

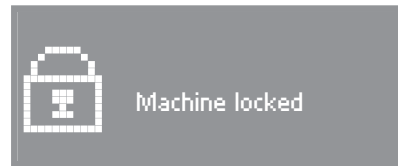

Miele

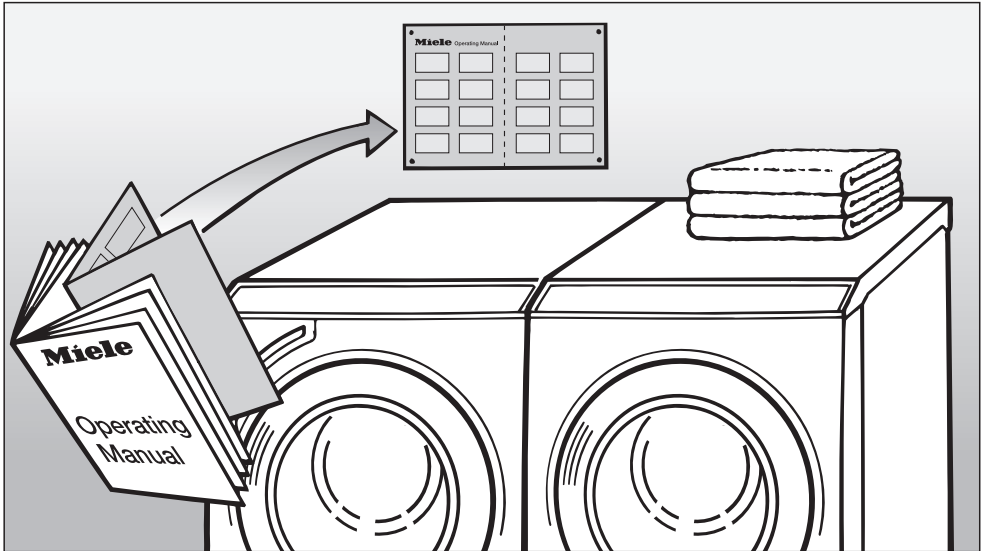

Quick guide

Remove this guide for easy reference

Please read all instructions, especially the "Important Safety Instructions", before using the washer.

Quick guide

1. Sort the laundry

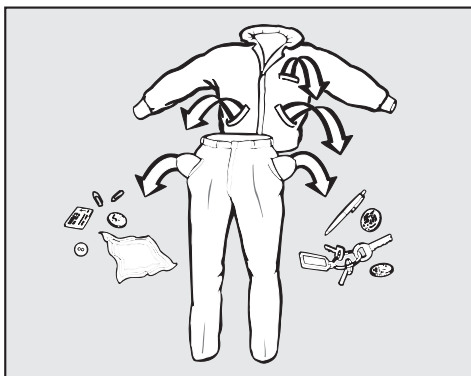

- Empty all pockets.
- Sort the laundry by fabric and color.
- Pretreat stains.

2. Turn on the washer



- Press the "On/Off" button. The washer is turned on and the program indicators light.

3. Load the laundry



- Press the "Door" button and load the laundry.
- Close the drum door.

To prevent damage to the door seal and clothing, make sure that there are no clothes caught between the drum door and the seal.

4. Selecting a program

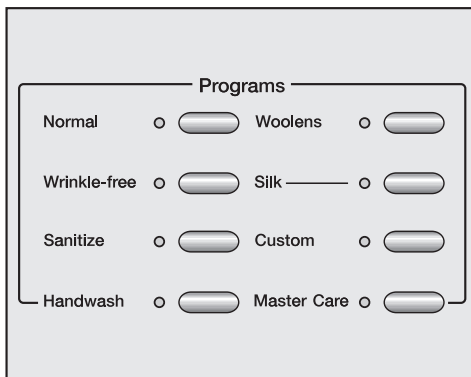

- Press the program button of the desired program.

The indicator of the selected program lights.

5. Selecting a temperature

The preselected temperature and/or spin speed can be adjusted if the program allows so.



By pressing the left button the temperature will be adjusted. Pressing the right button modifies the spin speed.

6. Selecting an Option

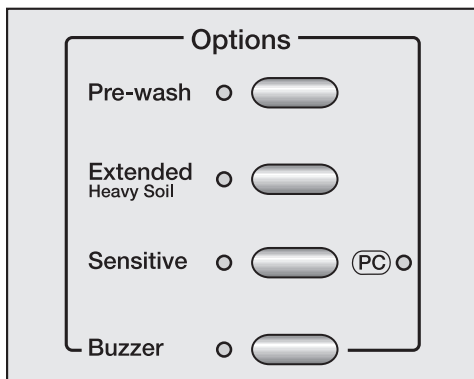

- Select the desired Option with the respective button. Once an Option is selected, the indicator lights.

7. Add detergent

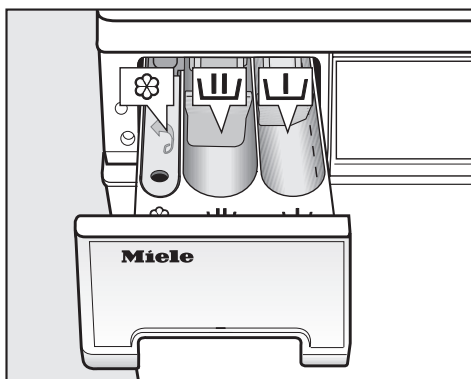

- Add detergent to the respective compartments.

8. Selecting Delay Start

- Press the "⏸" delay start button.



- With every touch of the "⏸" delay start" button, the start is delayed longer.

9. Starting a program

- Press the flashing "Start" button.

10. Activating the Child Lock

- Press and hold the "Heavy Soil" button until the display shows:



- Deactivate the Child Lock after the program has finished.

11. Unload the laundry

- Open the drum door.
- Remove the laundry.

Check the drum for any missed pieces of laundry. Items inadvertently left in the washer may be damaged (e.g. shrink or discolor) during the next wash cycle.

Quick guide

Program guide

	Sanitize	Hot	Very Warm	Warm	Cold	No Heat	Max spin	High spin	Med spin	Slow spin	Rinse hold	No Spin
Normal		X	X	X	X	X	X					
Wrinkle-free		X	X	X	X	X		X	X			
Sanitize	X	X					X	X				
Handwash				X	X	X			X			
Woolens				X	X	X		X	X	X	X	X
Silk					X	X				X		
Custom	X	X	X	X	X	X	X	X	X	X	X	X
Extra White		X	X				X	X				
Delicates				X	X	X			X	X	X	X
Denim / Jeans				X	X	X		X	X			
Dress shirts				X	X	X			X	X	X	X
Pillows		X	X	X				X	X	X		
Outerwear					X				X			
Table linens				X	X	X		X	X	X	X	X
Beach towels						X	X					
Express				X	X	X	X	X	X	X	X	X
Drain / Spin							X	X	X	X		X
Quick rinse								X	X	X	X	X

Selectable Options except for buzzer

	Normal	Wrinkle-free	Sanitize	Handwash	Woolens	Custom	Extra White	Delicates	Denim/Jeans	Dress shirts	Pillows	Table linens
Heavy Soil	X	X	X	X		X	X		X	X		X
Extended	X	X	X	X		X	X	X	X			X
Sensitive	X	X	X	X	X	X	X	X	X	X	X	X

Default settings are printed in **bold**.

 Before cleaning or maintenance, disconnect the power supply by unplugging the unit or manually "tripping" the circuit breaker.

 Do not use a hose to wash down the washer.

Cleaning the exterior and control panel

- Clean the exterior of the washer with a mild solution of non-abrasive detergent or soap and water, and wipe dry with a soft cloth.
- Clean the drum with a stainless steel cleaner specially formulated for use in a washing machine, available from Miele.

 Do not use chemical solvents, abrasive cleaners, glass or all purpose cleaners! They will damage the surface.

Cleaning the drum

Miele suggests running a **"maintenance cycle"** approx. once a month to ensure that your washing machine remains clean and free of any soil buildup or odors.

- **Do not** add laundry to the drum.
- Select the "Sanitize" program.
- Add 1/4 cup of detergent and/or bleach to the respective compartment (if desired).
- Run the program as normal through to completion.

Descaling the washer

If the correct amount of detergent is dispensed, the machine should not need to be descaled.

- If the washer needs to be descaled, use a descaling agent with corrosion protection. These special descaling agents can be purchased from Miele. Use as directed on the packaging.

Cleaning the detergent drawer

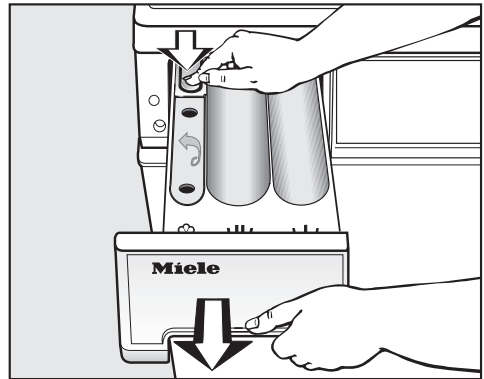

Detergent residue should be cleaned out regularly.

- Pull out the detergent drawer as far as it goes. Press down on the red release lever and pull the drawer out of the machine.
- Remove the liquid detergent inserts.
- Clean the detergent drawer with warm water.

Cleaning and care

- Clean the siphon tube.

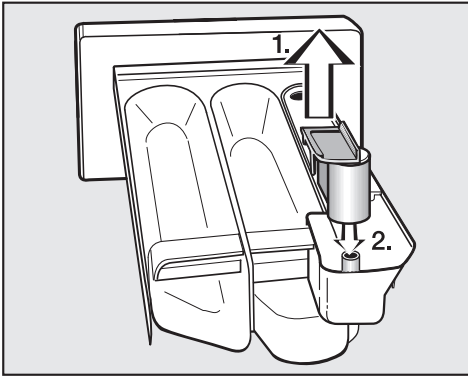

1. Remove the siphon tube from the compartment ⌘ and rinse under warm water. Clean the pipe on which the siphon tube is attached.
2. Replace the siphon tube.

Clean the siphon tube and fabric softener channel more often when frequently using liquid starch. Liquid starch tends to stick.

Cleaning the niche of the detergent drawer

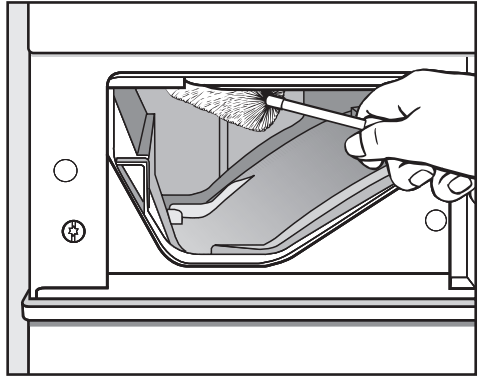

- Using a bottle brush remove any detergent or lime deposits from the water inlet valves at the top of the detergent drawer niche.

Cleaning the liquid detergent inserts

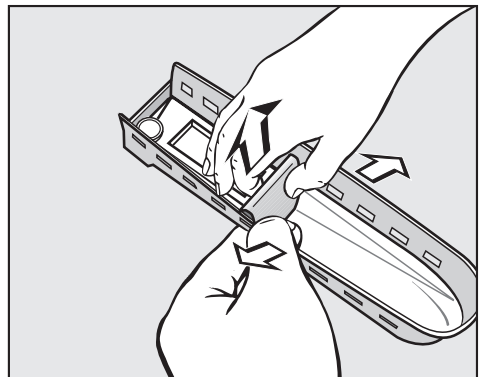

- Push the insert apart and remove the siphon for easy cleaning.

Cleaning the water inlet filters

The washer has two water inlet filters to protect each inlet valve. These filters should be checked and cleaned if necessary every 6 months. This may need to be done more frequently with some water supplies.

- Turn off the water supply.
- Unscrew the inlet hose from the valve by turning the connector counter-clockwise using a wrench if necessary.

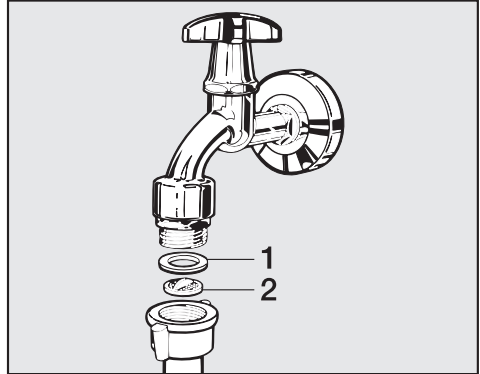

- Remove the rubber seal, **1**, from the connector.
- Using needle nose pliers, grasp the plastic filter, **2**, and pull it out of the hose connector.
- Clean the filter under running water and carefully remove any large particles.
- Replace the filter and seal then reconnect the hose.
- Slowly turn on the valve and check for leaks. If water leaks, tighten the bolt.

Both filters **must** be put back in place after cleaning.

Cleaning and care

Cleaning the drain pump and lint trap

Occasionally, small objects (buttons, coins, etc.) may become trapped in the lint trap. If the machine does not drain completely, the lint trap should be checked to ensure that it is free of foreign objects.

- Turn off the appliance with the "On / Off" button.

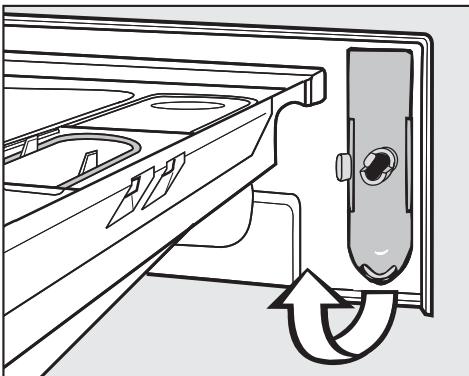

- To clean the lint trap, remove the tool from behind the detergent dispenser drawer.

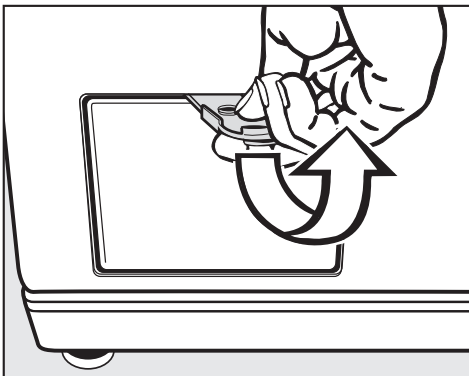

- Open the access panel.

 Caution: If laundry has been washed at a high temperature, the water draining out of the machine will still be hot! Allow it to cool before proceeding.

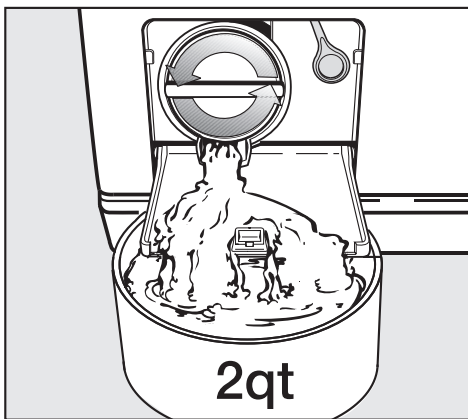

- Turn the lint trap lid counterclockwise. Do not remove it. About 2 quarts (2 liters) of water will drain out of the hose.

If the main drain hose is clogged, water will be retained in the machine (**a maximum amount of 6.5 gal [25 l]**).

If additional water remains in the machine, tighten the lint trap lid and empty the container. Repeat this procedure as often as necessary.

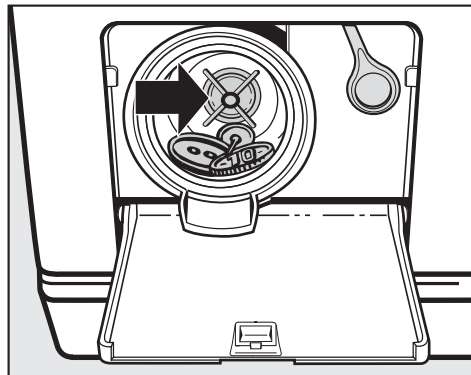
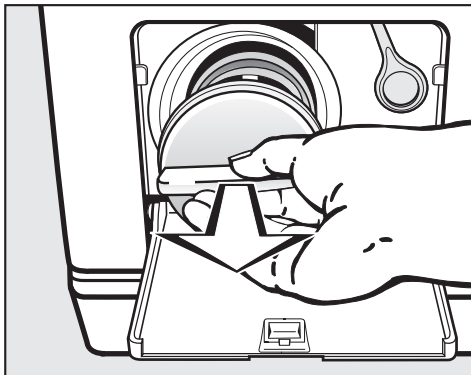

Once the flow of water stops:

- Remove the lint trap lid.
- Remove any foreign objects or lint from the filter.

- Check that the impeller (in the back of the chamber) rotates freely by spinning it with your hand.
- Return the lint trap and tighten into place.

 If the lint trap lid is not tightened securely, water will leak out when the machine is used.





Frequently asked questions

 Repairs to electrical appliances must only be carried out by a qualified and trained person in accordance with local and national safety regulations. Repairs and other work by unqualified persons could be dangerous.

The following section will help you avoid placing a service call by identifying issues you may encounter while operating the machine:

A wash program cannot be started		
Issue	Possible cause	Solution
The display stays blank and no indicator illuminates.	The washer has no power.	Check to determine if: <ul style="list-style-type: none">– the washer is plugged in.– the circuit breaker has tripped.
Immediately after the program start the washer cancels the program.	The "child entrapment sensor" has reacted.	<ul style="list-style-type: none">■ Open the drum door.■ Check the drum.■ Restart the program.

Frequently asked questions

The display shows a fault message		
Issue	Possible fault	Fix ¹⁾
 Drain fault Check drain	<ul style="list-style-type: none"> – The drain is blocked. – The drain hose is too high. 	<ul style="list-style-type: none"> – Clean the drain filter and the drain pump. – The maximum drain pump height is 3 ft (1m).
 Water inlet fault Open water faucet	<ul style="list-style-type: none"> – The water intake is blocked. 	Possible fault: <ul style="list-style-type: none"> – check if the water supply is open all the way. – the inlet hose is kinked.
 Waterproof system activated	The waterproof system has activated.	Call Technical Service.
 Technical fault Call Technical Service	There is a fault.	Restart the program. If the fault message appears again contact Technical Service.
In the display flashes Anti-crease alternating with Check detergent	The machine has oversudsed.	Use less detergent in the next wash program, and follow the recommended amount on the detergent packaging.

1) To turn off the fault message:

- To turn the fault message off: Open the drum door or press the "Cancel" button until the fault message goes out.

Frequently asked questions

General problems with the washer		
Issue	Possible cause	Solution
The washer shakes during the spin cycle.	The four feet are not resting evenly on the floor.	Level the machine (see "Leveling the washer").
There are unusual sounds coming from the drain pump.	There is no fault. Lapping sounds at the beginning and end of the drain process are normal.	
Large residues of detergent remain in the dispenser drawer.	The water pressure is too low.	Clean the water intake hose filter under running water and carefully remove any large particles.
	Water softeners tend to clump.	Clean the detergent drawer. In the future add the detergent first then the water softener.
The fabric softener is not completely dispensed or too much water remains in the "Softener" compartment.	The siphon tube is either positioned incorrectly or clogged.	Clean the siphon tube, see "Cleaning and care - Cleaning the detergent drawer".
The display shows a foreign language.	The display language was adjusted.	Select the display language. See "Setting the display language".

Frequently asked questions

Poor wash results		
Issue	Possible cause	Solution
The wash does not come clean with liquid detergent.	Liquid detergents do not contain bleaching agents. Fruit, coffee and tea stains cannot be effectively removed.	<ul style="list-style-type: none">– Use powdered bleach.– Do not put liquid detergent and stain remover together in the same wash compartment.
Laundry has a gray, sticky residue.	An inadequate amount of detergent was used to dissolve greasy deposits in heavily soiled laundry (e.g. grease, oils or lotions).	<ul style="list-style-type: none">– Add more detergent to the laundry or use a liquid detergent.– Run the "Sanitize" program without laundry using liquid detergent to clean the washer before using it for laundry again.
There is white detergent residue on dark laundry.	The detergent was not completely dissolved because of hard water.	<ul style="list-style-type: none">– After drying, remove white residue with a clothing brush.– Add a water softener to the detergent for future loads.

Frequently asked questions

The drum door cannot be opened	
Possible cause	Solution
The washer is not plugged in and/or not turned on.	Plug the washer in and turn it on by pressing the "I-On/0-Off" button.
The Child Lock is activated.	Deactivate the Child Lock as described in the chapter "Using the washer - Activating the Child Lock".
The door was not properly closed.	Push against the door on the lock side and press the "Door" button.
Power failure	Open the door as described on the following page.
There is still water in the drum and the washer cannot drain the water.	Clean the drain filter and drain pump. See "Cleaning and Care - Cleaning the drain pump and lint trap".
As a safeguard against scalding, the drum door cannot be opened if the wash water temperature is over 130°F (55°C).	

Opening the drum door during a power failure

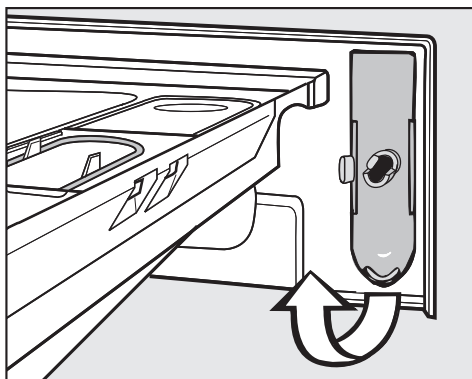

- Open the detergent dispenser drawer and remove the tool.

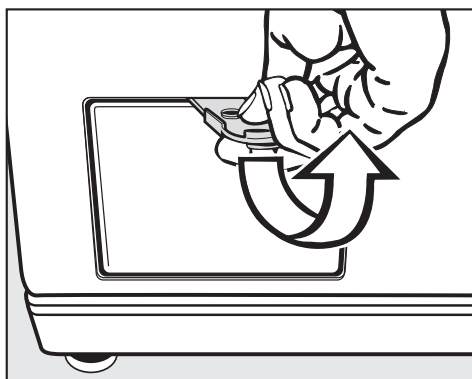

- Open the lint trap door.
- Drain the water from the washer as described in "Cleaning and Care - Cleaning the drain pump and lint trap".

⚠ Make sure the machine is turned off and the drum has stopped moving. A moving drum is dangerous.

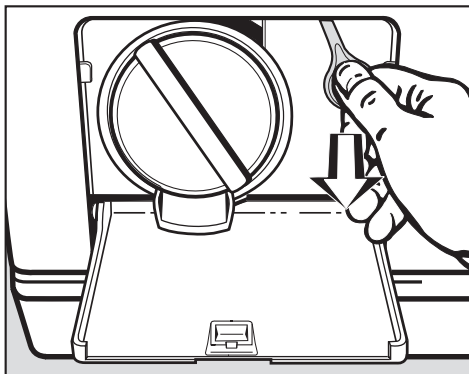

- To open the door, pull down on the ring in the upper right corner of the access area.

After sales service

Repairs

In the event of a fault which you cannot fix yourself, please contact Technical Service using the information on the back of this manual.

- Please quote the model and serial number of your appliance when contacting the Technical Service Department.

Both can be found on the data plate visible above the front glass on the inside of the door.

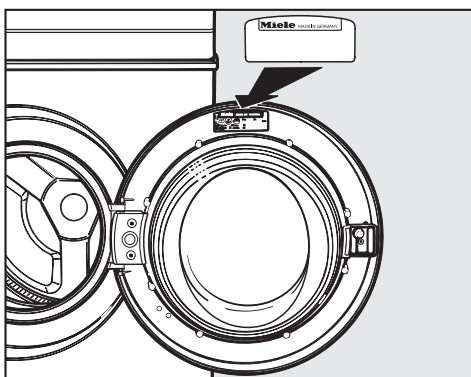

PC Update

The indicator marked PC allows a technician to make use of new technology. When, for example, new programs are developed or new fabrics are introduced, a service technician will be able to modify existing program cycles accordingly.

Miele will provide information when such possibilities become available.

Optional accessories

Optional accessories are available through your Miele dealer or Miele.

MieleCare

(USA only)

MieleCare, our Extended Service Contract program; gives you the assurance of knowing that your appliance investment is covered by 5 years of worry free ownership.

MieleCare is the only Extended Service Contract in the industry that guarantees repairs by a Miele Authorized Service Provider using genuine Miele parts. Only genuine Miele parts installed by factory trained professionals can guarantee the safety, reliability and longevity of your Miele appliance.

Please note that unless expressly approved in writing by the Miele Service department, Extended Service Contracts offered by other providers for Miele products will not be recognized by Miele. Our goal is to prevent unauthorized (and untrained) service personnel from working on your Miele products, possibly doing further damage to them, you and/or your home.

To learn more about **MieleCare** Extended Service Contracts, please contact your appliance dealer or visit us online at:

<http://mieleusa.com/mielecare>

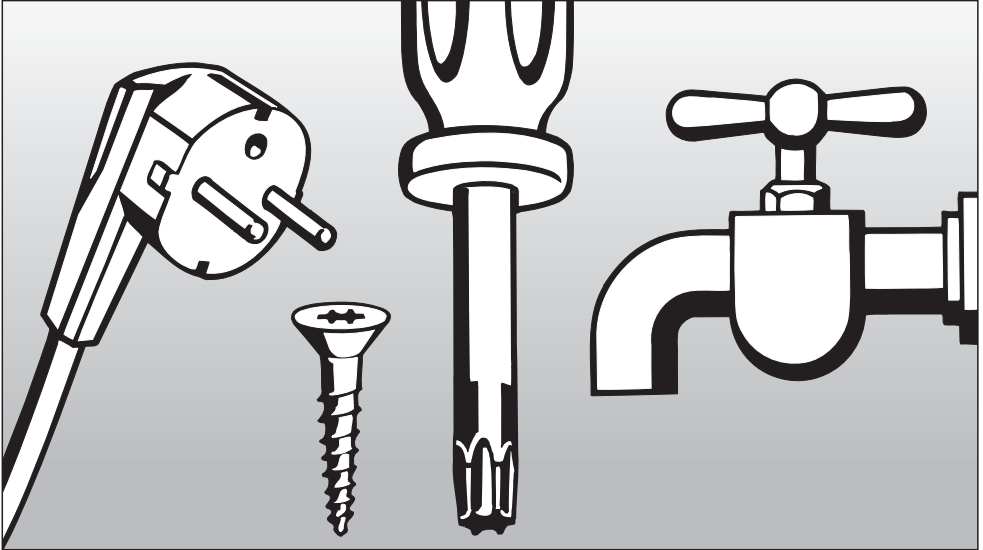

Installation Instructions

Information is subject to change. Please refer to our website to obtain the most current product specification, technical & warranty information.

To prevent accidents
and appliance damage
read these instructions

before
installation or use.

Installation

Front view

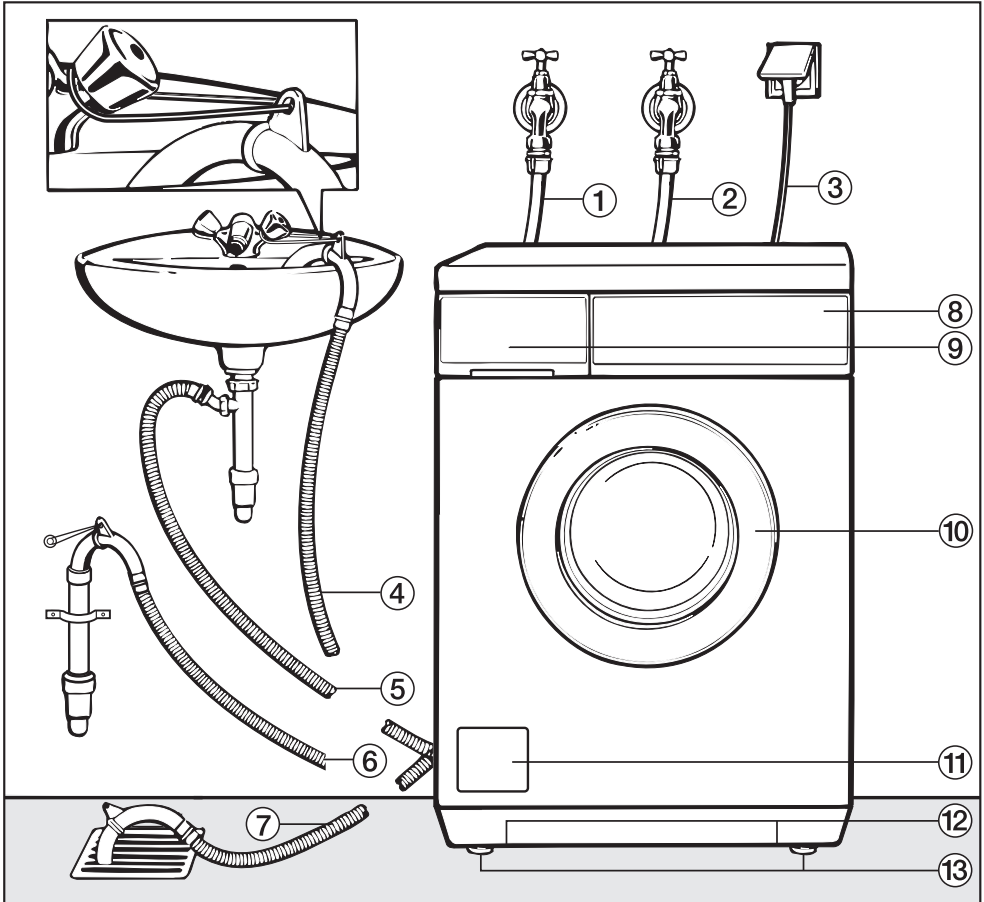

- ① Hot water intake hose
- ② Cold water intake hose
- ③ Power cord
- ④ - ⑦ Drain hose (drain options shown i.e adjustable and removable elbows).
- ⑧ Control panel
- ⑨ Detergent dispenser drawer
- ⑩ Drum door
- ⑪ Access panel to lint trap and drain pump
- ⑫ Recessed grip
- ⑬ Four height-adjustable feet

Rear view

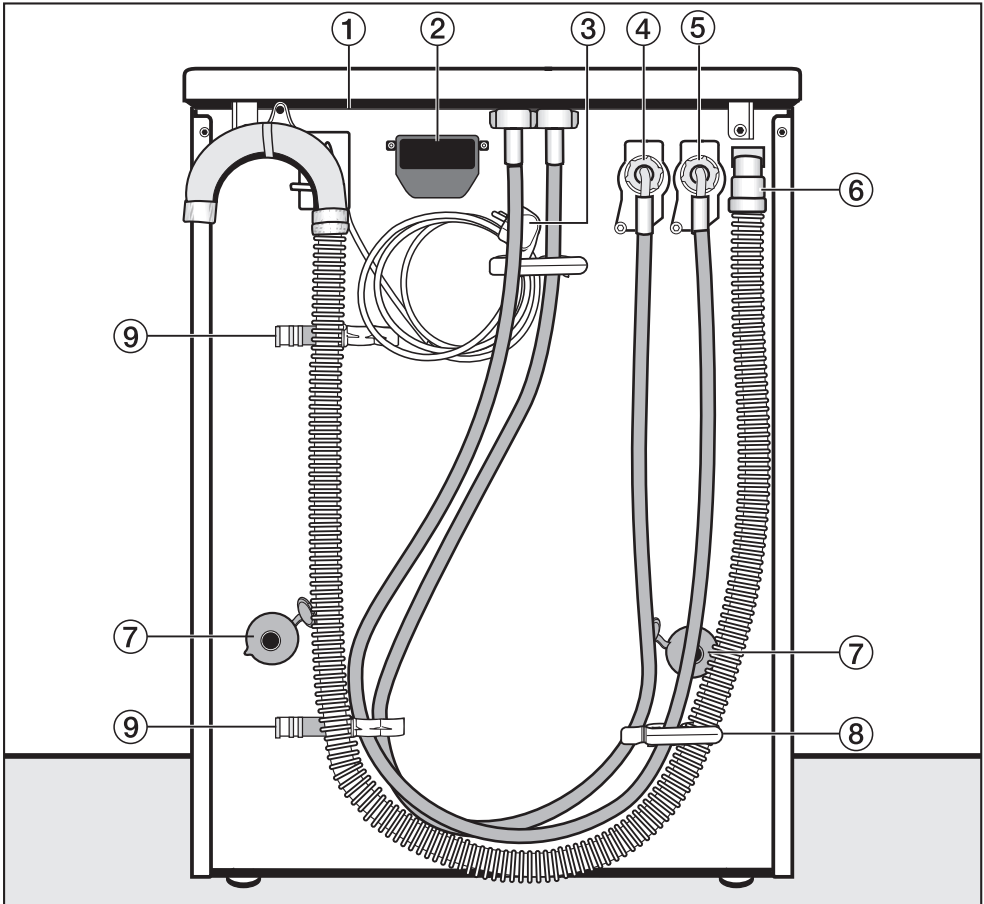

- | | |
|---|--|
| ① Lid excess end with transport grips | ⑥ Drain hose |
| ② W-LAN communication module (optional accessory) | ⑦ Shipping struts with rotary protection |
| ③ Power cord | ⑧ Brackets for intake and drain hoses |
| ④ Cold water intake hose | ⑨ Brackets for removed shipping struts |
| ⑤ Hot water intake hose | |

Installation

Installation site

A concrete floor is the most suitable surface for the washer. Concrete floors are less prone to vibration during the spin cycle than wooden floors.

Note:

- The machine must be leveled and securely positioned.
- To avoid vibration while spinning, the machine should not be installed on soft floor coverings.

If the installation must be performed on a wooden floor:

- Install the unit on a 2 ft. x 2 ft. x 1 ³/₁₆" (61 x 61 x 3 cm) plywood base. Ideally the base should be large enough to span several joists and should be anchored to the joists and not just the floor boards.

It is best to install the washer in the corner of a room, where the stability of the floor is at its greatest.

⚠ If the machine is installed on a raised platform, it should be secured with retaining clips. These clips are available from your dealer or Miele. If installed on a masonry or concrete base, the base should have a ¹/₂" to ³/₄" (12-20 mm) high rim. This is required to prevent the washer from vibrating off the stand during the spin cycle.

Installation

Use the front washer feet and the rear excess end to transport the washer from its shipping pallet to the installation site.

Do not lift the washer by the drum door!

⚠ Ensure that the machine's feet and the floor are dry to prevent slippage during the spin cycle.

Removing the shipping struts

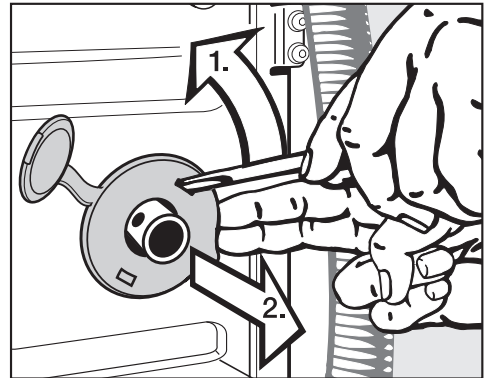

- Remove the left and right rotary protectors. Unhook, **1**, the rotary protectors with a screw driver and remove, **2**.

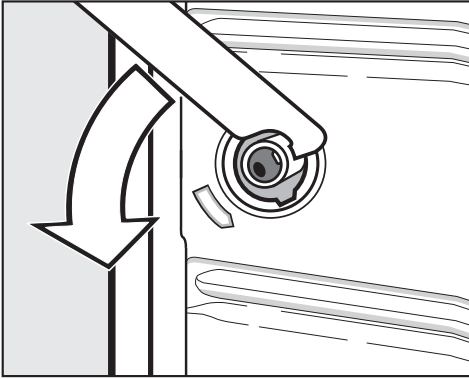

- Turn the left shipping strut counterclockwise 90° with the enclosed combination wrench.

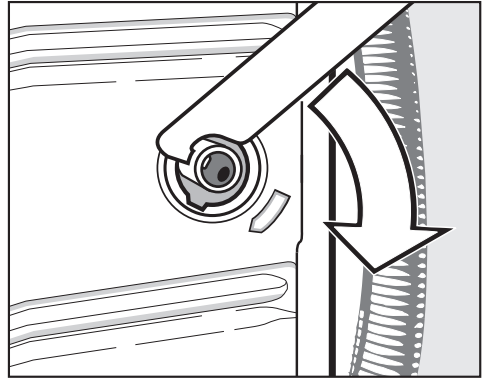

- Turn the right shipping strut clockwise 90° with the enclosed combination wrench.

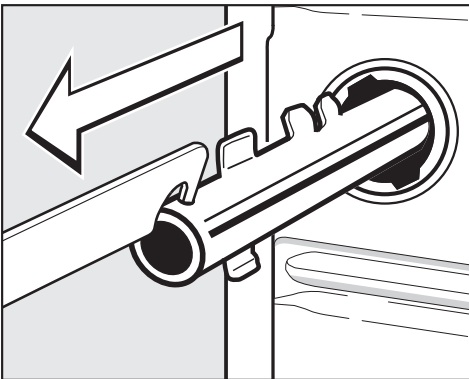

- Pull out the shipping strut.

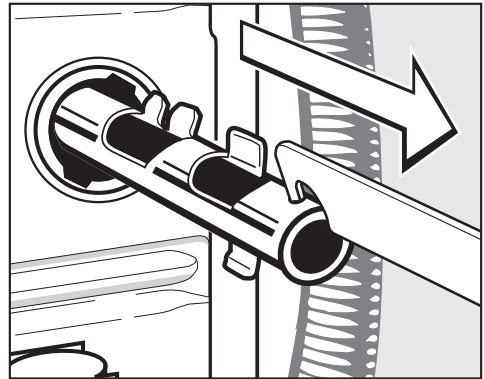

- Pull out the shipping strut.

Installation

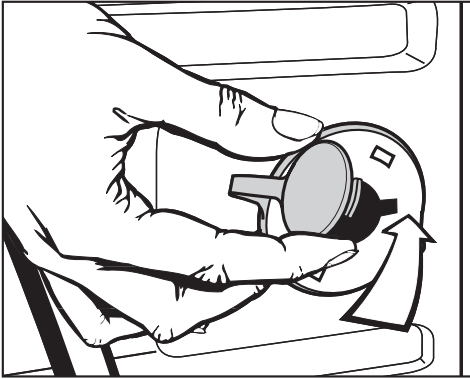

Installing the shipping struts

- Reinstall the struts by reversing the "Removing the shipping struts" procedure.

- Close the holes with the rotary protectors, making sure to close the caps.

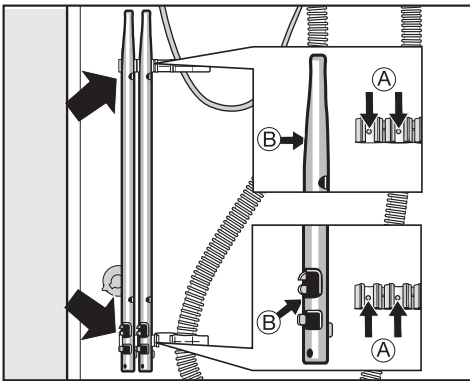

- Fasten the shipping struts to the rear of the washer. Take care to insert the drill holes correctly, **(B)**, into the clamps, **(A)**.

 Do not move the washer without the shipping struts in place.

Leveling the washer

To ensure smooth operation the washer must be level.

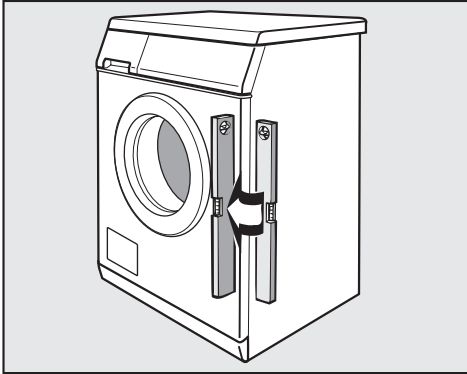

Failure to level the machine can result in increased water and energy consumption as well as the washer "banging" in the spin cycle or "walking" across the floor during use.

Adjust the four leveling feet

The washer is leveled by adjusting the four feet. The machine is boxed with the feet completely screwed in.

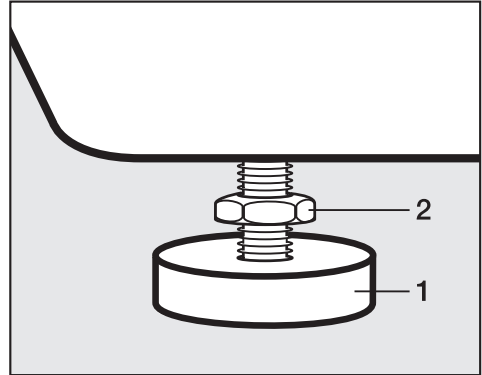

- Turn the locking ring, **2**, counter-clockwise with the enclosed combination wrench. Unscrew the each of the for feet as much as needed by turning both the foot, **1**, and locking ring, **2**, to the left.
- Check that the machine stands level.
- Once level, hold the foot, **1**, immobile with a wrench. Turn the locking ring, **2**, with the combination wrench towards the machine.

 All four locking rings must be tight against the bottom of the machine. In addition, check to see that the feet were not inadvertently unscrewed while tightening the rings. Running a machine that is not level or whose feet are not tight may cause damage to both the machine and its surrounding area.

Plumbing

The washing machine can be connected to a portable water supply. A non-return valve is not needed unless required by building code.

The washing machine has $\frac{1}{2}$ " (13 mm) pressure hoses with $\frac{3}{4}$ " (19 mm) female hose thread connections. If there is no water hookup, contact a plumber to install a connection. Make sure that the sealing ring is seated properly on the hose connector.

Replace the hose only with a genuine Miele hose, or with a hose able to withstand up to 145 psi (10 bar) pressure. The water valve connector must also be able to withstand 145 psi (10 bar).

 The bolted connection is under water pressure. Open the water supply slowly to check for leaks. Adjust the rubber seal and the bolted connection if necessary.

To protect the inlet valve, the two filters (one at the pressure hose / valve connection and one at the inlet connection to the solenoid valve) must not be removed.

Hose extension (optional accessory)

Hose extensions with a length of 8' $2\frac{7}{16}$ " to 13' $1\frac{1}{2}$ " (2.5 to 4 m) are available from Miele.

Water connection

- Connect the cold water intake hose (blue mark) to the cold water valve and the hot water intake hose (red mark) to the hot water valve.

If the machine is being connected only to a cold water supply, both the hot and cold water intake hoses must be attached to the cold water valve through the use of a Y adapter (available at a hardware store). Both hoses must be connected to a water source or the machine will not function properly.

Do not connect the washer to hot water only.

- Turn on the valve(s) and check for leaks. The water pressure must be within 15 -145 psi (1 -10 bar). If the water pressure is greater than 145 psi (10 bar) a pressure reducer must be installed. If the water pressure is below 15 psi (1 bar) there will not be enough water available for a complete fill.

The water intake hoses are equipped with screen filters. Do not remove these filters except for cleaning.

Tips for a hot water connection

The hot water temperature from the hot water valve must not exceed 140°F (60°C); the ideal temperature is 130°F (55°C).

If there is no water pressure at the hot water inlet, the unit will automatically switch to cold water after several minutes.

Plumbing

Drainage

The 5 ft (1.5 m) drain hose may be connected as follows:

1. Directly into a sink: hook the hose over the edge of the sink and secure it firmly (e.g. by tying the hose to the water faucet).
 2. To a stand pipe: place the drain hose into a 1 ½" (4 cm) stand pipe and secure it firmly.
 3. To a floor drain: The machine is equipped with an air gap / anti-siphoning system so that no minimum drain height is required.
- The machine drains using a pump with a maximum delivery height of 4 ft (1.2 m).
 - Make sure there are no kinks in the drain hose.

If necessary, the drain hose may be extended to run a maximum of 16 ft (4.9 m), as long as the 4 ft (1.2 m) height is not exceeded. Hose extensions are available from Miele.

GROUNDING INSTRUCTIONS

This appliance must be grounded. In the event of a malfunction or breakdown, grounding will reduce the risk of electric shock by providing a path of least resistance for electric current. This appliance is equipped with a cord having an equipment-grounding conductor and a grounding plug. The plug must be plugged into an appropriate outlet that is properly installed and grounded in accordance with all local codes and ordinances.

WARNING – Improper connection of the equipment-grounding conductor can result in a risk of electric shock. Check with a qualified electrician or service representative if you are in doubt as to whether the appliance is properly grounded.

Do not modify the plug provided with the appliance; if it will not fit the outlet, have a proper outlet installed by a qualified electrician.

ELECTRICAL INSTRUCTIONS

This installation should be performed by an experienced and qualified technician, in accordance with local codes and regulations.

The washing machine is supplied with a 5' 3" (1.6 m) long, 3 wire cord, ending in a NEMA 5-15P plug, ready for connection to a 120 V, 15 A, 60 Hz, AC power supply.

The proper outlet can be purchased from an electrical supply dealer.

Setting the display language

The display language can be changed at any time as long as no program is running.

- Press the "Extended" button until the display shows:



- Select the desired language by pressing the left menu button "◀". Confirm with "**OK**".

The display is shown in the selected language.

Disposal of the packing material

The cardboard box and packing materials protect the appliance during shipping. They have been designed to be biodegradable and recyclable.

Ensure that any plastic wrappings, bags, etc. are disposed of safely and kept out of the reach of children, as they pose a danger of suffocation.

Disposal of an appliance

Old appliances may contain materials that can be recycled. Please contact your local recycling center about the possibility of recycling these materials.

Ensure that the appliance presents no danger to children while being stored for disposal. Before discarding an appliance, unplug it from the outlet, cut off its power cord and remove any doors to prevent hazards.

Please have the model and serial number of your appliance available before contacting Technical Service.



**U.S.A.
Miele, Inc.**

National Headquarters

9 Independence Way
Princeton, NJ 08540
Phone: 800-843-7231
609-419-9898
Fax: 609-419-4298
www.mieleusa.com

**Technical Service & Support
Nationwide**

Phone: 800-999-1360
Fax: 888-586-8056

TechnicalService@mieleusa.com

**Canada
Miele Limited**

Headquarters and Showroom

161 Four Valley Drive
Vaughan, ON L4K 4V8
Phone: 800-643-5381
905-660-9936
Fax: 905-532-2290
www.miele.ca
professional@miele.ca
(commercial enquiries)

MieleCare National Service

Phone: 800-565-6435
905-532-2272
Fax: 905-532-2292
customercare@miele.ca
(general and technical enquiries)

Germany

Miele & Cie. KG
Carl-Miele-Straße 29
33332 Gütersloh

