

Operating instructions
Washer-disinfector
G 7823 / G 7824

To avoid the risk of accidents or damage to the machine it is **essential** to read these instructions before it is installed, commissioned and used for the first time.

en - GB, AU, NZ

M.-Nr. 07 776 620

Contents

| | |
|--|----|
| Warning and safety instructions | 4 |
| Symbols on the appliance | 8 |
| Intended Use | 9 |
| Guide to the machine | 10 |
| Controls | 13 |
| Water softener softener (Optional) | 15 |
| Setting the water softener | 15 |
| Reactivation display | 15 |
| Reactivating the water softener | 16 |
| Filling the salt container | 17 |
| Position the salt container as follows | 17 |
| Run the reactivation programme | 18 |
| Automatic mobile unit recognition (Optional) | 19 |
| Mobile unit coding | 20 |
| Setting mobile unit coding | 21 |
| Areas of application | 23 |
| Protein test | 23 |
| Loading the machine | 24 |
| Surgical instruments (OP) | 25 |
| Ophthalmology | 26 |
| Anaesthetic instruments (AN) | 27 |
| Baby bottles (BC) | 28 |
| Operating theatre shoes (OS) | 30 |
| Transfer trolley for loading and unloading the machine | 31 |
| Chemical processes and technology | 33 |
| Dispensing liquid chemical agents | 38 |
| Preparing the DOS dispensers | 39 |
| Fill the containers with the relevant agent | 39 |
| Venting the dispensing system | 41 |
| Dispensing system maintenance | 41 |
| External Dispensing systems | 41 |
| Operation | 42 |
| Master switch | 42 |
| Switching on | 42 |
| Door lock | 42 |
| To open the door | 42 |
| To close the door | 42 |

| | |
|---|----|
| Operating levels | 43 |
| Starting a programme | 44 |
| Programme sequence | 45 |
| Switching off | 46 |
| Cancelling a programme | 46 |
| Interrupting a programme | 47 |
| Data transfer | 48 |
| Maintenance | 49 |
| Periodic checks | 49 |
| Process validation | 50 |
| Routine checks | 50 |
| Cleaning the filters in the wash cabinet | 51 |
| Cleaning the coarse filter | 51 |
| Cleaning the coarse, flat and micro-fine filters | 52 |
| Cleaning the spray arms | 53 |
| Cleaning the control panel | 54 |
| Cleaning the front of the machine | 54 |
| Cleaning the wash cabinet | 54 |
| Cleaning the door seals | 54 |
| Mobile units, modules and inserts | 55 |
| Printer (optional) | 56 |
| Renewing the paper roll | 56 |
| Renewing the colour cassette | 56 |
| After sales service | 57 |
| Converting the type of heating | 58 |
| Converting from steam to electric heating or from electric to steam | 58 |
| Electrical connection | 59 |
| Plumbing | 60 |
| Technical data | 61 |
| Optional extras | 62 |
| Special processes - OXIVARIO and ORTHOVARIO | 63 |
| Description of the machine | 63 |
| Areas of application | 64 |
| Warning and Safety instructions | 65 |
| Connecting the H ₂ O ₂ solution container | 65 |
| Disposal of your old machine | 66 |

Warning and safety instructions

This appliance complies with all relevant legal safety requirements. Please note that incorrect use can lead to personal injury and damage to property.

To avoid the risk of accidents and damage to the appliance, please read these instructions carefully before starting to use it. Keep these instructions in a safe place for reference, and pass them on to any future user.

Correct application

▶ This washer-disinfector is designed for use with the applications described in these Operating Instructions only. Alterations or conversions to the machine, or using it for purposes other than those for which it was designed, are not permitted and could be dangerous.

This machine must only be used for cleaning and disinfecting instruments or medical devices if the manufacturer has stated that they are suitable for machine processing. Manufacturer's cleaning and maintenance instructions for instruments etc. must also be observed.

Miele cannot be held liable for damage caused by improper or incorrect use or operation of the machine.

▶ This machine is intended for indoor use only.

▶ This machine is not designed for use in mobile installations unless a risk assessment of the installation has been carried out by a suitably qualified engineer.

Please pay attention to the following notes to avoid injury and damage.

▶ This machine should be commissioned and then maintained by a Miele authorised and trained service technician only. A Miele service contract is recommended to ensure compliance with GLP Guidelines and the Medical Devices Directive. Unauthorised repairs could be dangerous, for which the manufacturer cannot be held liable.

▶ Do not install the machine in an area where there is any danger of explosion or of freezing conditions.

▶ The electrical safety of this machine can only be guaranteed if connected to a correctly installed earthing system on site. It is most important that this basic safety requirement is present and tested regularly, and where there is any doubt the on-site electrical system should be inspected by a qualified electrician.

The manufacturer cannot be held liable for damage or injury caused by the lack of or inadequacy of an effective earthing system (e.g. electric shock).

▶ A damaged or leaking machine could be dangerous and compromise your safety. Disconnect the machine from the mains immediately and call the Miele Service Department.

▶ Personnel operating the appliance should be trained regularly. Untrained personnel must not be allowed access to the machine or its controls.

Warning and safety instructions

▶ Take care when handling chemical agents such as cleaning agent, neutralising agent, rinsing agent etc. These may contain irritant or corrosive ingredients.

Please follow the manufacturer's safety instructions. Wear protective gloves and goggles. With all chemical agents, the manufacturer's safety instructions and safety data sheets must be observed.

▶ The machine is designed for operation with water and recommended additive chemical agents only. Organic solvents and flammable liquid agents must not be used in this machine.

These could cause an explosion, damage rubber and plastic components in the machine, and cause liquids to leak out of the machine.

▶ The water in the cabinet must not be used as drinking water.

▶ Be careful when sorting items with sharp pointed ends and positioning them in the machine that you do not hurt yourself or create a danger for others. Sharp knives etc. should be placed in baskets with the pointed ends facing downwards.

▶ When using this machine in the higher temperature ranges, be especially careful not to scald or burn yourself or come into contact with irritant substances when opening the door. Where disinfecting agents are used there is a danger of inhaling toxic fumes.

▶ Where there is a risk of toxic or chemical substances occurring in the suds solution (e.g. aldehyde in the disinfecting agent), it is essential to regularly check door seals and make sure that the steam condenser is functioning correctly.

Opening the machine door during a programme interruption carries particular risks in such circumstances.

▶ Should personnel accidentally come into contact with toxic vapours or chemical agents, follow the emergency instructions given in the manufacturer's safety data sheets.

▶ Mobile units, modules, inserts and the load must be allowed to cool down before they are unloaded. Any water remaining in containers could still be very hot. Empty them into the wash cabinet before taking them out.

▶ After using the hot air drying unit, open the door to allow the everything in the cabinet from the load itself to the mobile units, modules and inserts to cool down.

▶ Steam heating is permissible up to a pressure of 1000 kPa (10 bar). This corresponds to a water steam temperature of 179°C.

▶ Never clean the machine or near vicinity with a water hose or a pressure washer.

▶ The machine must be disconnected from the mains electricity supply before any maintenance or repair work is carried out. Do not reconnect it until the maintenance or repair work has been successfully completed.

Warning and safety instructions

The following points should be observed to assist in maintaining quality standards when processing medical devices, in order to protect patients, and to avoid damage to the loads being cleaned.

▶ If the machine is being used for disinfection in accordance with official regulations on the control of epidemics, the steam condenser and its connections to and from the wash cabinet must be cleaned and disinfected whenever any repairs are carried out or parts replaced.

▶ If it is necessary to interrupt a programme in exceptional circumstances, this may only be done by authorised personnel.

▶ The standard of cleaning and disinfection in the disinfection programmes must be routinely confirmed by the user. The process should be validated on a regular basis, and checked against documented control results. Chemical disinfection procedures should also be validated using chemical or bio indicators.

▶ For thermal disinfection, use temperatures and temperature holding times to achieve the required infection prophylaxis in accordance with current health and safety regulations.

▶ Disinfection programmes which use a chemical disinfecting agent at moderate temperatures such as 65 °C or lower are not recognised by §18 IfSG for disinfection. They should only be used for items which cannot withstand the higher temperatures used by thermal disinfection. The range of effective disinfection is based on claims made by the producer of the disinfecting agent. Their instructions on handling, use and effectiveness must be observed. The use of chemical disinfection procedures is the responsibility of the operator.

▶ Theatre (OP) shoes should only be cleaned and disinfected in a machine installed specifically for this purpose.

▶ Only use chemical agents formulated for special processes and approved by Miele for use with this machine. Use of unsuitable agents could adversely affect the components of the machine. In the event of any damage or material deterioration please contact your Miele application specialist.

▶ Pre-treatments with cleaning or disinfecting agents can create foam, as can certain types of soiling and chemical agents. Foam can have an adverse effect on the disinfection and cleaning result.

▶ Foam must not be able to escape from the wash cabinet. It would hinder the correct functioning of the machine.

▶ Check the process used regularly to monitor foaming levels.

Warning and safety instructions

▶ To avoid the risk of damage to the machine and any accessories used with it caused by chemical agents, soiling and any reaction between the two please read the notes in "Chemical Processes and Technology".

▶ Where a chemical agent is recommended on technical application grounds (e.g. a cleaning agent), this does not imply that the manufacturer of the machine accepts liability for the effect of the chemical on the items being cleaned.

Please be aware that changes in formulation, storage conditions etc. which may not be publicised by the chemical manufacturer, can have a negative effect on the cleaning result.

▶ When using cleaning agents and specialised products it is essential that the manufacturer's instructions are followed. Chemicals must only be used for the purpose they are designed for and in the situation specified, to the exclusion of other chemicals, to avoid such dangers as chemical reactions and material damage.

▶ In critical applications where very stringent requirements have to be met, it is strongly recommended that all the relevant factors for the process, such as chemical agents, water quality etc. are discussed with the Miele Application Technology specialists.

▶ If the cleaning result is subject to particularly stringent requirements, a regular quality control test should be carried out by the user to ensure that required standards of cleanliness are being achieved.

▶ Mobile units, modules and inserts should only be used for the purpose they are designed for. Hollow instruments must be thoroughly cleaned, internally and externally.

▶ Empty any containers or utensils before arranging them in the machine.

▶ Do not allow any remains of acids or solvents, and in particular hydrochloric acid or chloride solutions, to get into the wash cabinet. Similarly avoid any materials with a corrosive effect. The presence in compounds of any solvents should be minimal (especially those in hazard class A1).

▶ Ensure that solutions or steam containing hydrochloric acid do not come into contact with the steel outer casing of the machine, to avoid any corrosion damage.

▶ Please follow the advice on installation in these instructions and the separate Installation Instructions.

Using accessories

▶ Only use genuine Miele original accessories with this machine. Consult Miele on the type and application of such equipment.

▶ Only use Miele mobile units, modules and inserts in this machine. Using accessories made by other manufacturers, or making modifications to Miele accessories, can result in unsatisfactory cleaning and disinfecting results, for which Miele cannot be held liable. Any resultant damage would also invalidate the machine guarantee.

Warning and safety instructions

► Only use chemical agents which have been approved by their manufacturer for use in the application you are using. The chemical agent manufacturer is responsible for any negative influences on the material the load is made from and for any damage they may cause to the machine.

Symbols on the appliance



Warning:
Observe the operating instructions.



Warning:
Danger of electric shock.

Disposing of your old machine

► Please note that the machine may have contamination from blood or other bodily fluids in it and must be decontaminated before disposal. For environmental and safety reasons ensure the machine is completely drained of any residual water, chemical residues and cleaning agent. Observe safety regulations and wear safety goggles and gloves. Make the door lock inoperable, so that children cannot accidentally shut themselves in. Then make appropriate arrangements for its safe disposal. For tank system machines ensure that any water is emptied out of the tank.

The manufacturer cannot be held liable for damage caused by non-compliance with these Warning and Safety instructions.

This washer-disinfector can be used to clean, rinse, disinfect (thermally and chemically) and dry a wide range of reusable medical devices.

Follow the manufacturer's instructions (according to EN ISO 17664) on how to process their items by machine.

Examples of application areas:

- surgical instruments,
- minimally invasive instruments,
- anaesthetic and intensive care instruments,
- baby bottles and teats,
- stainless steel and aluminium containers (including anodised aluminium),
- operating theatre shoes.

Processing medical devices by machine achieves reproducible results, and should be used in preference to processing them by hand.

Where disinfection is required for the protection of staff and/or patients, a thermal disinfection programme, e.g. the DESIN vario TD programme, should be selected.

The parameters for thermal disinfection according to EN ISO 15883-1 (A_0 concept) vary depending on the disinfection standard required. They are 80 °C (+ 5 °C, - 0 °C) with a 10 min holding time (A_0 600) or 90 °C (+ 5 °C, - 0 °C) with a 5 min holding time (A_0 3000). An A_0 value of 3000 is suitable for deactivating the HBV virus.

National health and safety regulations regarding disinfection must also be observed.

The cleaning programme as well as any chemical agents must be chosen according to the type of soiling and load being processed.

The agents used for processing the products should be selected to suit the level of cleaning required as well as the method of analysis used.

The cleaning result must ensure that the instruments can be disinfected correctly, that no residues are left behind, that subsequent sterilisation can be carried out and that the instruments can be used again safely. Medical devices are best processed using the DESIN vario TD programme, or the ORTHOVARIO or OXIVARIO programme where applicable.

The use of a suitable carrier (mobile unit, module, insert etc.) is important to ensure the adequate cleaning of the load. Examples are given in the section "Areas of application".

The washer-disinfector is programmed to carry out the final rinse with mains water or with processed water of a quality to suit the application (e.g. aqua destillata, purified water, de-ionised water, demineralised water).

This machine complies with EN ISO 15883 for validation purposes.

Guide to the machine

Unclean side

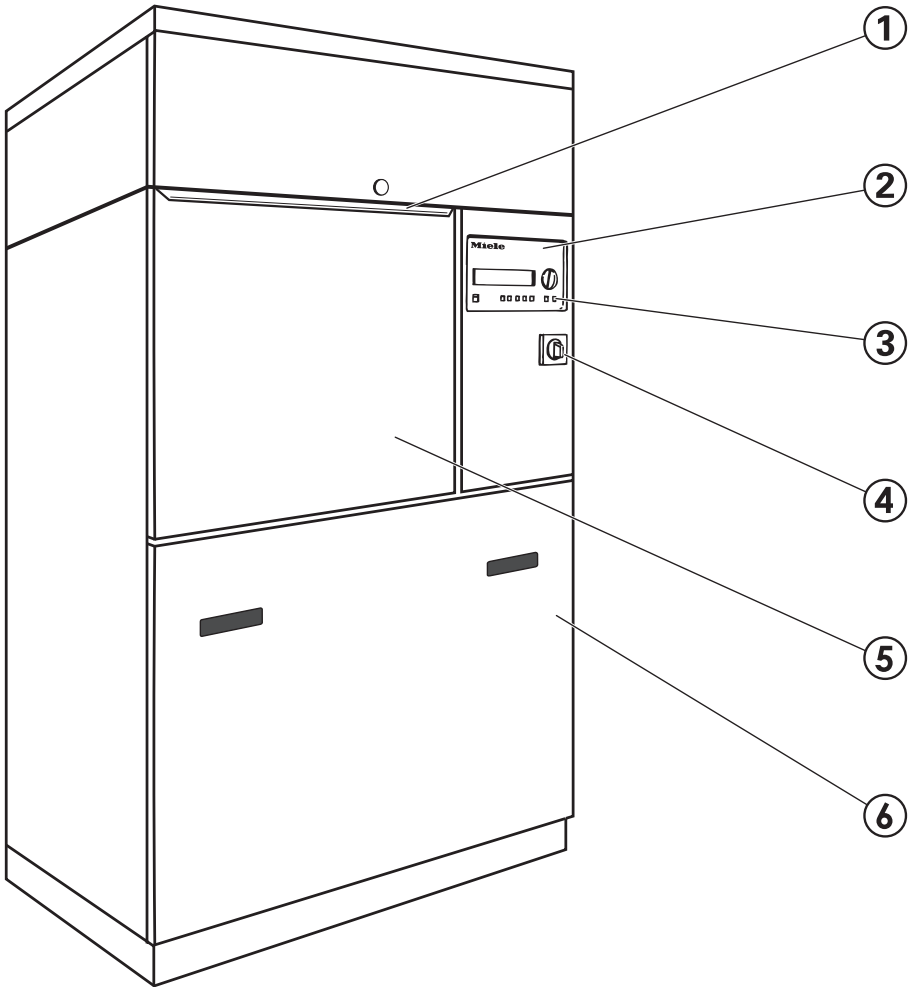

① Handle

② Profitronic electronic controls (see the Programming manual for more information)

③ Controls

④ Master switch (with emergency cut-off function for service work)

⑤ Drop-down door (closed)

⑥ Service panel

Unclean side

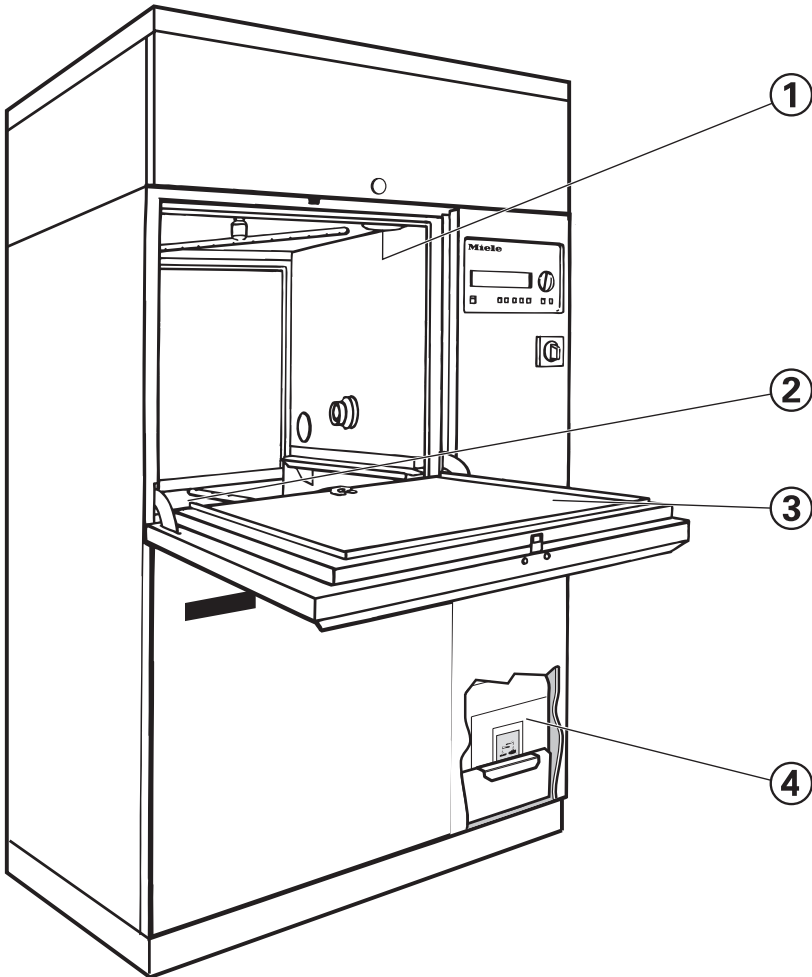

- ① Salt container connection point
(for the water softener)
- ② Filter combination
- ③ Drop-down door (open)
- ④ Containers for dispensing systems
DOS 1 / DOS 3
(DOS 2 / DOS 4 optional)

Guide to the machine

Clean side (G 7824 only)

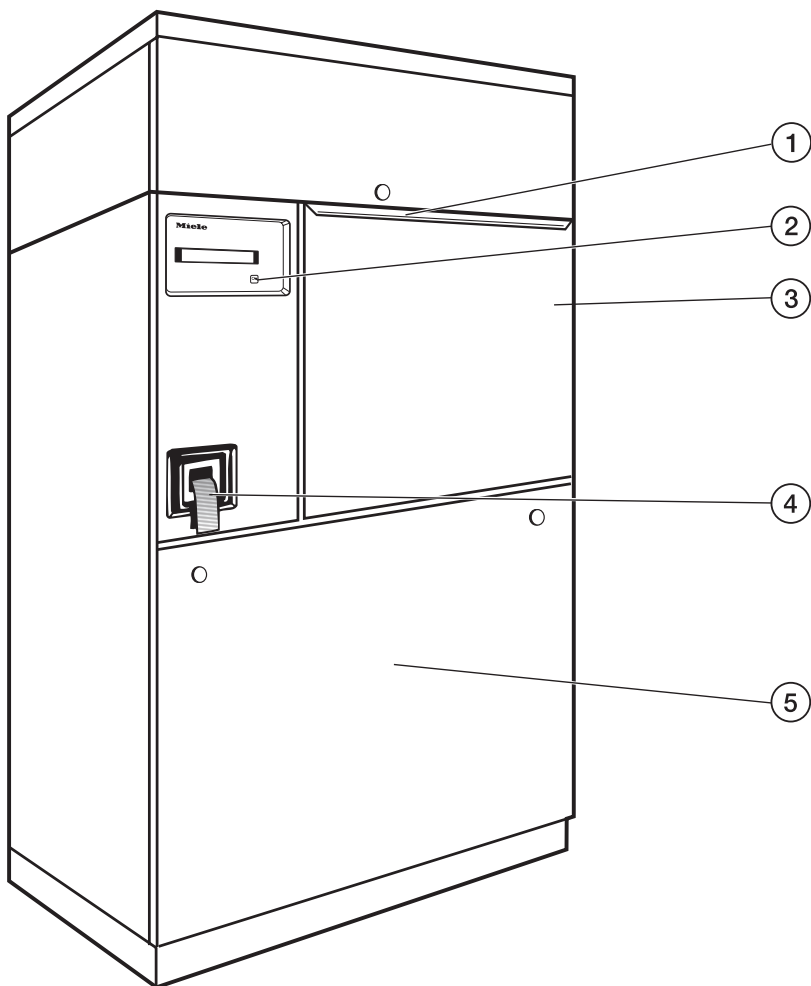

① Handle

② Door release

③ Drop-down door (closed)

④ Printer (optional)

G 7823: on the unclean side

⑤ Service panel

Controls

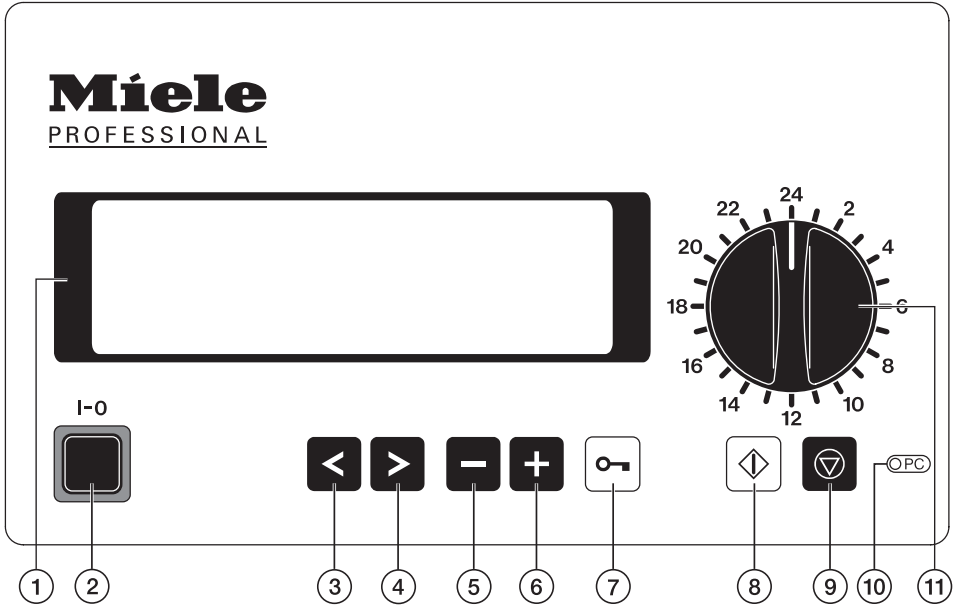

① Display

with screen saver;
i.e. background lighting switches off automatically after
15 mins. Press any button to switch the display back on
again.

Faults occurring during operation are shown in the display.
They are listed in a chart in the Programming manual.

② On/Off button (I-O)

③ Cursor button: left ◀

Moves the cursor to the left:

- to the previous menu point
- to the previous parameter
- to the previous input position

Guide to the machine

- ④ **Cursor button**  Moves the cursor to the right:
 - to the next menu point
 - to the next parameter
 - to the next input position

- ⑤ **Minus button** 
 - Selects programmes from position 24 upwards
 - Scrolls back page by page in menus
 - Is used for entering numbers and letters
 - Alters pre-settings e.g. service parameters

- ⑥ **Plus button** 
 - Selects programmes from position 24 upwards
 - Scrolls forward page by page in menus
 - Is used for entering numbers and letters
 - Alters pre-settings e.g. service parameters

- ⑦ **Door switch** 

- ⑧ **Start button** 
 - Starts programmes
 - Activates input mode
 - Confirms activated values and settings
 - Confirms menu points for entry into the relevant sub-menu

- ⑨ **Stop button** 
 - Cancels a programme
 - Exits from input screen without saving
 - Exits from menu screen

- ⑩ **Service interface** 

- ⑪ **Programme selector**
Selects programme places 1-23

Water softener softener (Optional)

In order to achieve good cleaning results, the washer-disinfector needs to operate with soft water. Hard water results in the build-up of calcium deposits on instruments, etc, and in the washer-disinfector.

Mains water with a hardness level higher than 0.7 mmol/l (4° d – German scale) needs to be softened. This takes place automatically in the integrated water softener.

- The water softener requires reactivation salt.
- The washer-disinfector must be programmed to correspond to the water hardness in your area.
- Your local water authority will be able to advise you on the water hardness in your area.

The water softener is set ex-works for a hardness level of 3.4 mmol/l or 19°d.

If your water hardness differs from this (even if it is below 0.7 mmol/l or 4°d) you will need to programme the level into your machine.

Where the water hardness fluctuates e.g. between 1.4 - 3.1 mmol/l (8 - 17 °d German scale) always programme the washer-disinfector to the higher value (3.1 mmol/l in this example).

The built-in water softener has settings from 1 °d - 60 °d (0.2 - 10.8 mmol/l).

For future servicing it is useful to make a note of your water hardness level.

Enter your water hardness level here:

_____ °d or mmol/l

Setting the water softener

When the machine is first commissioned the Miele service technician has to set the machine for your local water hardness level (see Programme manual, Operation/Reactivation).

Reactivation display

After a certain number of cycles the message REACTIVATION will appear in the display to warn you that the water softener is depleted and cannot supply any more softened water. **As soon as** the programme has finished **reactivation salt** will need to be replenished.

If this cannot be done immediately, and further cleaning cycles have been carried out, the reactivation process will need to be carried out twice in succession.

Water softener softener (Optional)

Reactivating the water softener

Please only use special coarse grained reactivation salt with granules of approx. 1-4 mm. Do not use other types of salt, e.g. table salt, agricultural or gritting salt. These could contain components which are insoluble in water which could result in damage to the water softener. If in doubt consult the Miele Professional Department.

The salt container holds approx. 2 kg of salt.

If only fine grained reactivation salt is available please consult the MIELE Professional Sales office for advice.

Salt with granules > 4 mm must not be used in this machine.

 Inadvertently filling the salt reservoir with cleaning agent can cause serious damage to the water softener and damage the filter insert, and cause pressure to build-up in the salt container. To avoid the risk of injury please exercise caution when removing the salt container as there may be irritant alkaline solutions present.

Before filling the salt container make sure that you have picked up the right packet of reactivation salt.

Water softener softener (Optional)

Filling the salt container

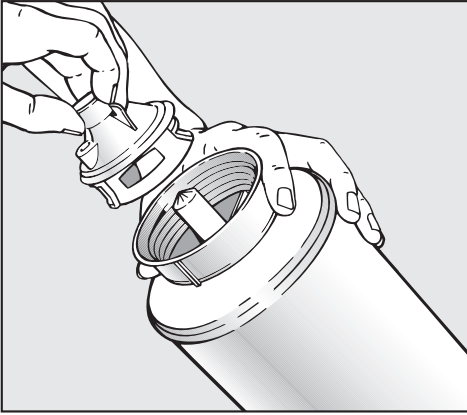

- Unscrew the filter insert from the salt container and remove.
- Fill the salt container with reactivation salt and screw the filter insert back in place.

Position the salt container as follows

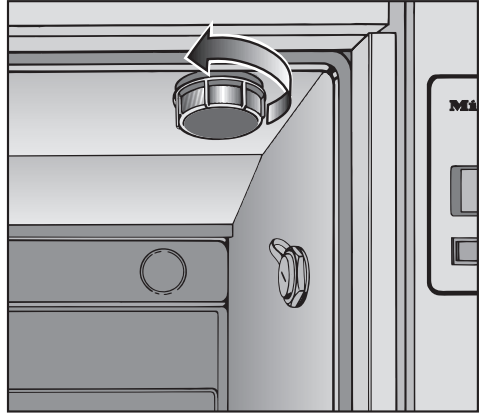

- Remove any mobile units from the cabinet.
- Unscrew the plastic cap situated in the top right-hand side of the cabinet.

 There will be a small amount of residual water in the cap. Take care as it may be hot from the previous programme.

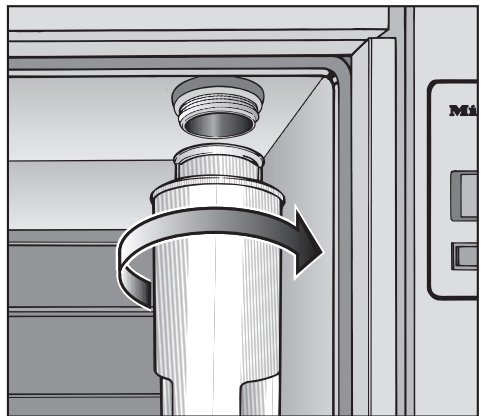

- Screw the salt container firmly onto the socket.

Water softener softener (Optional)

Run the reactivation programme

- Close the door.
- Open the stopcocks.
- Select the REACTIVATION programme.

The programme will run automatically.

Then:

- Switch off the machine.
- Carefully unscrew the salt container, making sure any water pressure still remaining can depressurise. Do not use force!
If the container will not come off manually please contact the Miele Service Department.
- Replace the plastic cap.
- Push the mobile unit back into the cabinet.
- Turn off the stopcocks.
- Empty the salt container. Do not empty it into the wash cabinet.
- Rinse the salt container and filter insert with clean water.

The water pressure (flow pressure at the take off point) must be at least 100 kPa (1 bar).

If it is below 100 kPa (1 bar) or if it fluctuates a lot, the water softener will not work properly. After reactivation, salt remains may still be found in the salt container.

To use up salt remains and to rinse out the water softener, the REACTIVATION programme must be carried out again.

Automatic mobile unit recognition (Optional)

In operating level C the automatic mobile unit recognition system (AWK) allocates programme places from 1 - 15 to mobile units with the correct coding.

The unit coding (on the mobile unit) and the programme place with the corresponding programme (in the electronic control unit) have to match each other.

To do this:

- Each mobile unit must be coded before being used for the first time (see "Coding the mobile unit"), and
- The programme for which the mobile unit is coded must be allocated to the correct programme place.

See "System function - Selector switch organisation" in the Programming manual for information on how to change programme positions.

 Before starting a programme it is **absolutely essential** that you check that the programme shown in the display is the correct one for the mobile unit being used. Otherwise inadequate cleaning or disinfection could be the result. Please make sure, that the places assigned for the programmes using Automatic mobile unit recognition are not changed around arbitrarily.

Automatic mobile unit recognition (Optional)

Mobile unit coding

The automatic mobile unit recognition feature assigns a programme place to a mobile unit. The mobile units must be coded with a magnetic strip (via a Bit combination).

In operating level C, the only programme available for a coded mobile unit is the one assigned to the corresponding programme place.

After a coded mobile unit has been put into the machine and the door closed, the automatic mobile unit recognition system will select the allocated programme.

 Make sure that there are no small metallic objects or instrument parts attracted to the magnetic strip, in particular to the underside of it. Any metallic objects on the strip can result in the coding being incorrectly read.

Press  to start the programme.

Coding is effected through 5 Bits:

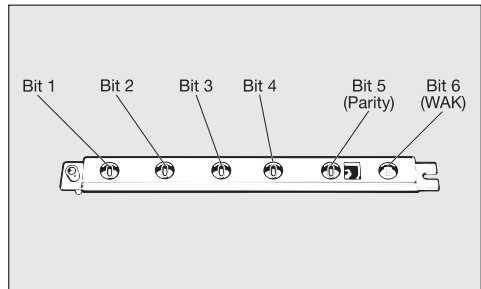

- Bits 1 to 4 define the mobile unit code,
- Bit 5 serves as a control (Parity Bit).

Bit 6 controls the volume of inflowing water and the circulation pump for mobile units with side coupling (WAK). Its settings cannot be altered. Mobile units without side coupling are coded with tracks which do not contain Bit 6.

Automatic mobile unit recognition (Optional)

Mobile unit coding strip

15 different codes can be set. They are assigned to programme places 1 to 15.

Under "System function, Selector switch organisation" the matching programmes have to be put into the first 15 programme places.

| Programme place | Bit 1 | Bit 2 | Bit 3 | Bit 4 | Bit 5 Parity Bit |
|-----------------|-------|-------|-------|-------|------------------|
| - | 0 | 0 | 0 | 0 | 0 |
| 1 | 1 | 0 | 0 | 0 | 1 |
| 2 | 0 | 1 | 0 | 0 | 1 |
| 3 | 1 | 1 | 0 | 0 | 0 |
| 4 | 0 | 0 | 1 | 0 | 1 |
| 5 | 1 | 0 | 1 | 0 | 0 |
| 6 | 0 | 1 | 1 | 0 | 0 |
| 7 | 1 | 1 | 1 | 0 | 1 |
| 8 | 0 | 0 | 0 | 1 | 1 |
| 9 | 1 | 0 | 0 | 1 | 0 |
| 10 | 0 | 1 | 0 | 1 | 0 |
| 11 | 1 | 1 | 0 | 1 | 1 |
| 12 | 0 | 0 | 1 | 1 | 0 |
| 13 | 1 | 0 | 1 | 1 | 1 |
| 14 | 0 | 1 | 1 | 1 | 1 |
| 15 | 1 | 1 | 1 | 1 | 0 |

The coded total must be an even number.

The settings on Bit 6 (WAK) are not included in this calculation.

If the coded total gives an odd number, the message CHECK MOBILE UNIT RECOGNITION appears.

If the mobile unit code equals 0, the message NO MOBILE UNIT RECOGNITION appears. In neither case can the programme be started, The mobile unit recognition function must be re-set.

Setting mobile unit coding

To set or alter the coding of a mobile unit with automatic recognition (AWK), proceed as follows:

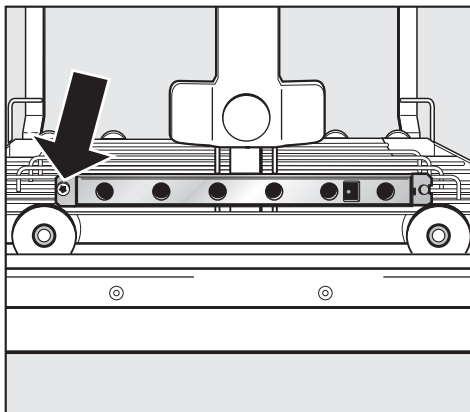

- Unscrew the track with AWK (using an allen key) and remove from the retainer.

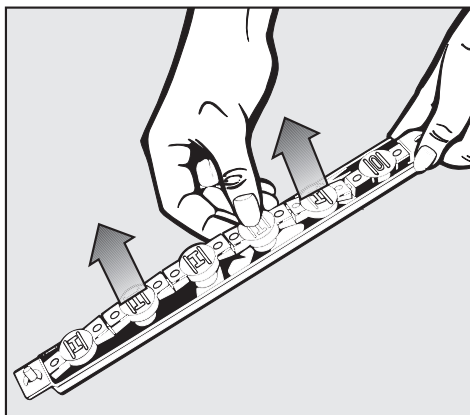

- Remove the magnetic strip from the track.

Automatic mobile unit recognition (Optional)

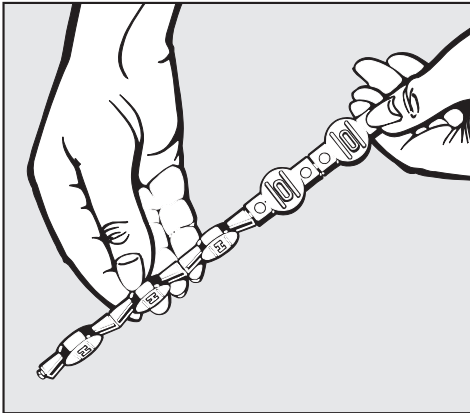

- Set the programme place coding.

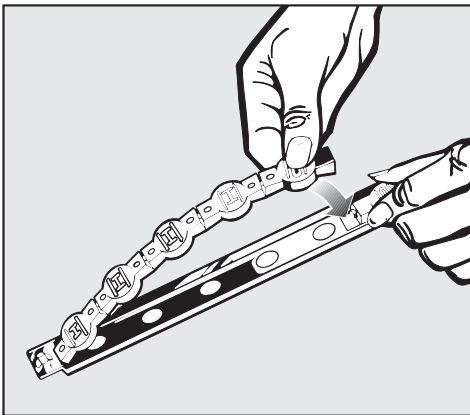

- Put the magnetic strip back in the track.

The magnetic strip must be placed in the track such that the Bit coding set out in the chart is visible through the round windows in the track.

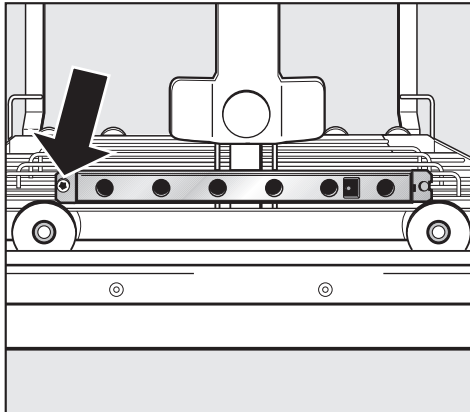

- Place the track in the holder in the mobile unit and screw firmly in place.

Bit 6 (WAK) is not a component part of the modifiable magnetic strip. Make sure that you code mobile units with side connection with a track where Bit 6 is set to 1. Mobile units without side coupling must be coded with a track without Bit 6.

The magnetic strips on G 7823 / G 7824 / G 7825 / G 7826 must have **grey** magnets.

The magnetic strips on G 7827 / G 7828 must have **black** magnets.

This washer-disinfector can be fitted with a variety of mobile units, which can be equipped with a variety of modules and inserts depending on the type and shape of items requiring cleaning and disinfection.

Select mobile units, modules and inserts which are appropriate for the application.

Notes on the individual areas of application and examples of loading are given on the following pages.

Before starting a programme you should carry out a visual check on the following:

- Is everything correctly loaded/connected for cleaning?
- Are the spray arms clean and do they rotate freely?
- Are the filters clean? Remove any coarse soiling and clean them properly if necessary.
- Is the adapter connecting the water supply to the spray arms/jets correctly connected?
- Are all chemical containers sufficiently filled?

At the end of each programme:

- Carry out a visual check of the load for cleanliness.
- Check that all hollow shafted instruments are still securely located on their jets.

 Any hollow instruments that have become disconnected from their adapters during processing must be re-processed.

- Check that the lumen of hollow instruments are free of obstruction.
- Check that jets and connectors are securely held in position in the baskets or inserts.

Protein test

Cleaning results should be subjected to **periodic** protein tests, e.g. with the Miele test kit.

Areas of application

Loading the machine

- Arrange the load so that water can access all surfaces. This ensures that it gets properly cleaned.
- Do not place items to be cleaned inside other pieces where they may be concealed.
- Hollow instruments must be thoroughly cleaned, internally and externally.
- Ensure that instruments with long narrow hollow sections can be flushed through properly before placing them in inserts or connecting them to jets.
- Hollow vessels should be inverted and placed in the correct mobile units, modules and inserts to ensure that water can flow in and out of them unrestricted.
A cover can be used to reduce the risk of glass breakage during the wash process.
- Lightweight items should be secured with a cover net (e.g. an A 6) and small items placed in a mesh tray to prevent them blocking the spray arms or being attracted by the magnetic strip on the automatic mobile unit recognition system.
- Deep-sided items should be placed at an angle to make sure water runs off them freely.
- Tall, narrow pieces should be placed in the centre of the baskets. This ensures good water coverage.

- Mobile units with an adapter must engage correctly.
- Modules must be correctly connected in the mobile unit.
- The spray arms must not be blocked by items which are too tall or which hang down in their path. If in doubt, test for free movement by manually rotating the spray arms.
- It is advisable to use only instruments made of special application steel which are not susceptible to corrosion.
- Instruments which cannot withstand high temperatures should be chemically disinfected.

 Disposable instruments must not be put into the machine for processing.

Preparing the load

Empty all containers before loading into the machine (paying particular attention to regulations regarding infectious diseases and epidemics).

 Ensure that acids and residual solvents, especially hydrochloric acid or chlorides, cannot get into the wash cabinet.

Unloading instruments

Instruments should be unloaded dry ready for further processing.

Surgical instruments (OP)

Surgical instruments should be stored for as short a time as possible before machine processing.

The OXIVARIO or ORTHOVARIO processes should be used for instruments where there is a long delay between the time they are used and the time they can be reprocessed. See "Special processes" at the end of this booklet.

Disinfection of surgical instruments and of those used for minimally invasive surgery should preferably take place thermally.

Fully demineralised water should be used for the final rinse when possible to ensure no marks are left on the load and to avoid corrosion. If the water used contains more than 100 mg chloride/litre there is danger of corrosion.

OP-containers can be disinfected thermally in the CONTAINER programme, or chemically. If anodised aluminium containers are used the final rinse must be carried out with fully demineralised water. These containers **must not** be processed with an alkaline cleaning agent in a 93 °C programme with 10 minutes holding time (according to § 18 IfSG).

When cleaning **narrow lumen instruments e.g. those used for minimally invasive surgery**, an intensive internal cleaning result is imperative. The **Vario-TD** and **OXIVARIO** programmes are the only ones which offer a thorough enough level of cleaning for this. It is essential that instruments are loaded as directed and that the cleaning agent used is suitable for the programme and for the sensitive instruments being processed. The final rinse must be carried out using fully demineralised water with a conductivity level of ~15 µS/cm (microsiemens per centimeter).

Instruments with very narrow lumen must be manually pre-rinsed where necessary. Follow the instrument manufacturer's instructions on how to handle them.

Mobile units for surgical instruments and containers are supplied with their own operating instructions.

Areas of application

Ophthalmology

Ophthalmic instruments should be cleaned and disinfected in a special mobile injector unit.

The top level is fitted with various connections for hollow instruments, e.g. rinsing and suction hand pieces, and cannulae.

Instruments are secured to the hose connectors in the mobile injector unit using the silicone holders and connectors in the rack.

The lower level of the mobile injector unit is designed to take E 441/1 inserts or E 142 mesh trays for processing solid instruments.

 Plastic fibre cover nets must not be used in washer-disinfectors which are used to process hollow ophthalmic instruments with narrow lumen.

The mobile injector unit for ophthalmic instruments is supplied with its own operating instructions.

Anaesthetic instruments (AN)

Anaesthetic instruments should be thermally disinfected using the DES-VAR-TD-AN programme.

If this is not possible, they can be processed using a chemical disinfection programme. The water level in the machine should be increased when using a chemical disinfection programme. To establish the effectiveness of disinfection, consult the manufacturer of the disinfecting agent being used.

If the process is not to be followed by sterilisation, the load should be dried completely to avoid the development of water-borne bacteria.

A sufficient drying time is, therefore, absolutely essential.

Mobile units for anaesthetic instruments are supplied with their own operating instructions.

Areas of application

Baby bottles (BC)

Baby bottles can be processed in E 135 containers, wide-necked teats in an E 364 insert and screw connection teats in an E 458 insert.

- Ensure the level marker on the bottles is machine-washable.
- If there is a delay of 4 hours or more before bottles can be washed, fill them with water to prevent residues from drying on.

If the process is not to be followed by sterilisation, the load should be dried completely to avoid the development of water-borne bacteria.

A sufficient drying time is therefore absolutely essential.

Inserts for baby bottles and teats are supplied with their own operating instructions.

Loading in an E 555

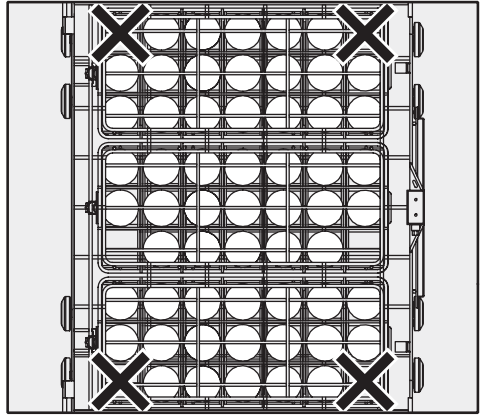

Bottom level with 3 x E 135

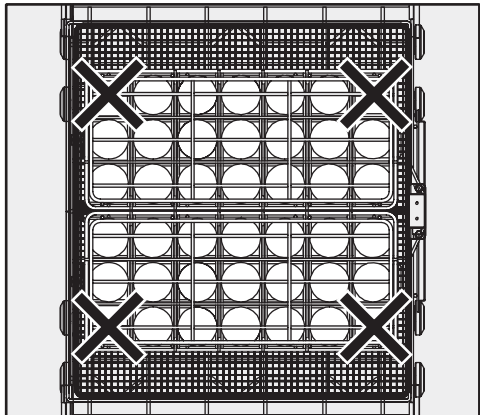

Top level with 2 x E 135

E 750 frame

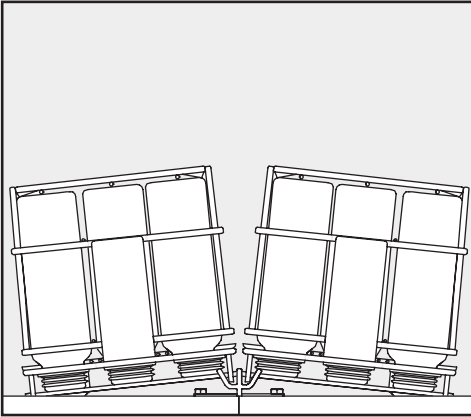

- Place the frame centrally in the top level of the E 555 mobile unit.
- Hook one E 135 container onto each side of the frame.

The angled positioning of the containers ensures that the jets of water reach right into the bottles.

The two blocked corners in the inserts should be located over the positions marked with an X on the drawing. The jets of water cannot get into the bottles properly in these positions to clean them.

Areas of application

Operating theatre shoes (OS)

Polyurethane operating theatre shoes, and/or insoles should be cleaned and chemically disinfected at 60 °C. These can only be thermally disinfected (using programme SHOE-TD-75/2) if the manufacturer states that they are made of a suitably heat-resistant material.

To establish the effectiveness of chemical disinfecting agents for disinfection consult the manufacturer.

Theatre shoes should be cleaned and disinfected **in a machine installed specifically for this purpose only**.

Moble unit E 550 with a suitable insert e. g. E 730, can be used for this purpose.

A large amount of fluff can build up in the machine when cleaning theatre shoes. The filters in the wash cabinet should therefore be checked regularly, and cleaned when necessary. See "Cleaning and care".

Transfer trolley for loading and unloading the machine

⚠ When a disinfection process is being carried out according to nationally laid down hygiene standards (e.g. § 18 IfSG), the contaminated surfaces of the trolley must be disinfected, after the machine has been loaded, using a spray disinfectant in accordance with national health and safety regulations and § 18 IfSG. Disinfecting agents listed by DGHM (German institute for microbiology and hygiene) are also suitable.

The height of the transfer trolley can be adjusted using the feet.

The height should be set so that the open machine door is held underneath the side catches on the transfer trolley.

If the machine is not fitted on a plinth the position of the foot pedal on the transfer trolley may need to be changed.

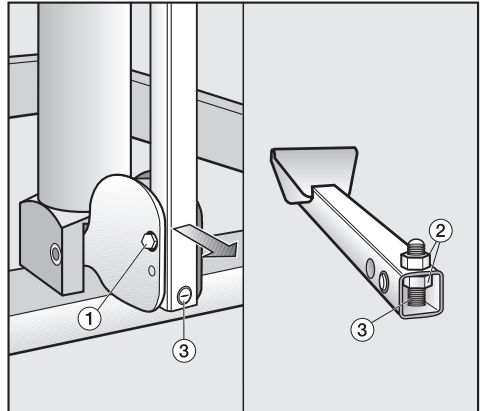

- Unscrew foot pedal ①.
- Loosen counter nut ② on adjusting screw ③.
- Screw adjusting screw ③ further into the foot pedal, so that the stopping point is reached earlier.
- Re-secure the adjusting screw.
- Screw the foot pedal back on.

Areas of application

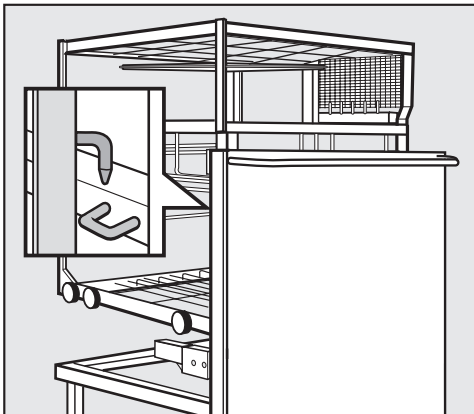

- Hang the mobile unit into the locating slots on the transfer trolley using both hooks.
- To lift the mobile unit step down on the transfer trolley foot pedal.
- Push the transfer trolley under the open door on the washer-disinfector as far as it will go. The mobile unit will then sit over the door.
- Secure the brakes on the wheels.

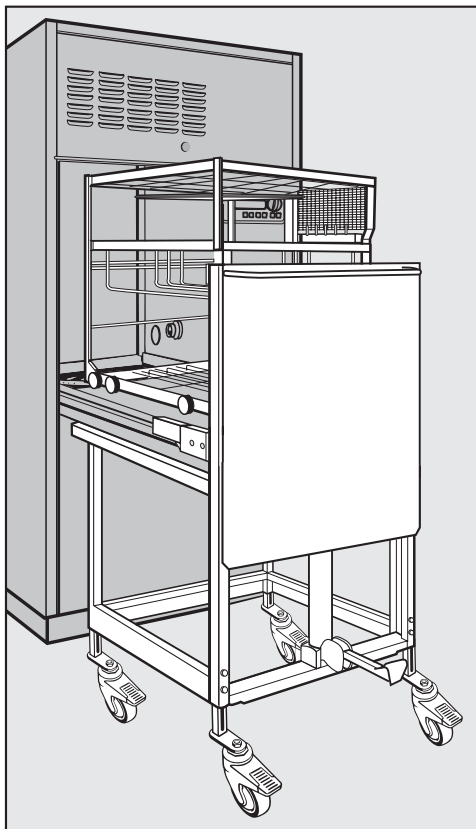

- To lower the mobile unit step right down on the foot pedal.
- At the end of the programme push the transfer trolley up to the washer-disinfector making sure that the door of the machine is held underneath the side catches on the transfer trolley.
- Then pull the mobile unit out as far as it will go onto the open door, so that it can be lifted up and taken away by the transfer trolley.

Chemical processes and technology

General notes

Problem

If seals, hoses and plastics in the washer-disinfector suffer damage they will not be water-tight and will not function correctly.

Heavy foaming during a programme affects cleaning and rinsing results. Foam escaping from the wash cabinet can cause damage to the washer-disinfector. Cleaning processes cannot be regulated and validated where there has been a build-up of foam..

Corrosion to stainless steel in the wash cabinet and to accessories can give them a different appearance:

- Rust (red marks / discolouration),
- black marks / discolouration,
- white marks / discolouration (etched surface).

Corrosive pitting can lead to the washer-disinfector not being water-tight. Depending on application corrosion can influence cleaning and rinsing results (laboratory analysis) or cause corrosion to stainless steel items in the cabinet.

How to resolve it

- Establish the cause of the damage and rectify it.

See information regarding "Chemical agents", "Soiling" and "Reaction between chemical agents and soiling".

- Establish the cause of the foam and rectify it.

- Check the process used regularly to monitor foaming levels.

See information regarding "Chemical agents", "Soiling" and "Reaction between chemical agents and soiling".

- Establish the cause of the corrosion and rectify it.

See information regarding "Chemical agents", "Soiling" and "Reaction between chemical agents and soiling".

Chemical processes and technology

Chemical agents

| Problem | How to resolve it |
|--|---|
| <p>The ingredients in chemical agents have a strong influence on the longevity and functionality (throughput) of the dispensing system. The dispensing system (hoses and pumps) should be set up for a particular type of chemical agent.</p> <p>General types:</p> <ul style="list-style-type: none"> – Alkaline to pH neutral products, – acidic to pH neutral products, – hydrogen peroxide. | <ul style="list-style-type: none"> – Use Miele approved chemical agents in this machine. – Carry out a regular visual check of the dispensing system for any damage. – Regularly check the flow rate of the dispensing system. |
| <p>Chemical agents can damage elastomers and plastics in the washer-disinfector and accessories.</p> | <ul style="list-style-type: none"> – Use Miele approved chemical agents in this machine. – Carry out a regular visual check of any accessible elastomers and plastics for damage. |
| <p>The following oxidising chemical agents can damage elastomers (hoses and seals) and plastics in the washer-disinfector:</p> <ul style="list-style-type: none"> – Nitric acid, – peracetic acid, – products containing active chlorine. | <p>The wash temperature should be limited to:</p> <ul style="list-style-type: none"> – 50 °C Nitric acid, – 35 °C with peracetic acid, – 80 °C with products containing active chlorine. |
| <p>The following chemical agents can release large amounts of oxygen:</p> <ul style="list-style-type: none"> – Hydrogen peroxide, – peracetic acid. | <ul style="list-style-type: none"> – Only use approved processes such as OXIVARIO or OXIVARIO PLUS. – The wash temperature must be less than 70 °C when using hydrogen peroxide. – Please contact Miele Service or your Miele Application Professional for advice. |

Chemical processes and technology

| Chemical agents | |
|---|---|
| Problem | How to resolve it |
| <p>The following chemical agents can cause large amounts of foam to build up:</p> <ul style="list-style-type: none">– Cleaning agents and rinsing agents containing tensides,– emulsifiers. <p>Foam can occur:</p> <ul style="list-style-type: none">– in the programme block in which the chemical agent is dispensed,– in the following programme block if it has been spilt,– in the following programme with rinsing agent if it has been spilt. | <ul style="list-style-type: none">– Process parameters in the wash programme, such as dispensing temperature, dosage concentration etc. must be set to ensure the whole process is foam free or very low foaming.– Please observe chemical agent manufacturer's instructions. |
| <p>De-foaming agents, especially silicone based ones can cause the following:</p> <ul style="list-style-type: none">– Deposits to build up in the cabinet,– deposits to build up on the load,– damage to elastomers and plastics in the washer-disinfector,– damage to certain plastics (e.g. polycarbonate and plexiglass) in the load being processed. | <ul style="list-style-type: none">– De-foaming agents should be used in exceptional cases only, for instance when absolutely essential for the process.– The wash cabinet and accessories should be periodically cleaned without a load and without de-foaming agent using the ORGANICA programme.– Please contact Miele Service or your Miele Application Professional for advice. |

Chemical processes and technology

Soiling

| Problem | How to resolve it |
|--|---|
| <p>The following substances can damage elastomers (hoses and seals) and plastics in the washer-disinfector:</p> <ul style="list-style-type: none"> – Oil, wax, aromatic and unsaturated hydrocarbons, – emollients, – cosmetics, hygiene and care products such as creams (analytical applications). | <ul style="list-style-type: none"> – Refit the washer-disinfector with oil resistant elastomeres. – Depending on usage wipe the lower door seal on the washer-disinfector periodically with a lint-free cloth or sponge. Clean the wash cabinet and accessories without a load using the ORGANICA programme. – Prepare the load using the "OIL" programme (where this is available) or use a special programme that dispenses emulsifiers. |
| <p>The following substances can lead to a heavy build-up of foam during washing and rinsing:</p> <ul style="list-style-type: none"> – Some disinfecting agents and dishwashing detergents, – reagents for analysis e.g. for microtiter plates, – cosmetics, hygiene and care products such as shampoos and creams (analytical applications), – active foaming agents such as tensides. | <ul style="list-style-type: none"> – Thoroughly rinse items in water beforehand. – Select a cleaning programme with at least one short pre-rinse in cold or hot water. – Depending on application use de-foaming agents that do not contain silicone oils. |
| <p>The following substances cause corrosion to stainless steel in the wash cabinet on accessories:</p> <ul style="list-style-type: none"> – Hydrochloric acid, – other substances containing chlorides such as sodium chloride etc., – concentrated sulphuric acid, – chromic acid, – Particles of iron and swarf. | <ul style="list-style-type: none"> – Thoroughly rinse items in water beforehand. – Place items drip dried into mobile units, baskets and inserts and then place these in the wash cabinet. |

Chemical processes and technology

Reaction between chemical agents and soiling

| Problem | How to resolve it |
|---|--|
| Natural oils and fats can be emulsified with alkaline chemical agents. This can lead to a heavy build-up of foam. | <ul style="list-style-type: none">- Where available use the "OEL" programme.- This special programme dispenses emulsifiers (pH neutral) in the pre-rinse.- Depending on application use de-foaming agents that do not contain silicone oils. |
| Soiling containing high protein levels such as blood can cause a heavy build-up of foam when processed with alkaline chemical agents. | <ul style="list-style-type: none">- Select a cleaning programme with at least one short pre-rinse in cold water. |
| Non-precious metals such aluminium, magnesium and zinc can release hydrogen when processed with very acidic or alkaline chemical agents (oxyhydrogen reaction). | <ul style="list-style-type: none">- Please observe chemical agent manufacturer's instructions. |

Dispensing liquid chemical agents

 Only use agents formulated specifically for use in washer-disinfectors and make sure you follow the manufacturer's instructions.

 Further information regarding the OXIVARIO and ORTHOVARIO programmes and connection of the H₂O₂ solution container can be found at the end of this booklet under "Special processes - OXIVARIO and ORTHOVARIO".

This machine is fitted with 2 dispensers as standard:

- Dispensing system DOS 1 (blue) to dispense liquid cleaning agent. It can dispense up to 120 ml/min.
- Dispensing system DOS 3 (red) to dispense acid media such as neutralising agent or rinsing agent. It can dispense up to 20 ml/min.

Additional optional DOS modules:

- Dispensing system DOS 2 (white) to dispense acid media such as neutralising agent / conditioning agent. It can dispense up to 20 ml/min.
- Dispensing system DOS 4 (green) for low-foaming disinfecting agents suitable for machine use, or for an additional cleaning agent. It can dispense up to 120 ml/min.

The correct amount of liquid agent etc. required for the application chosen will then be dispensed through these dispensing systems.

OXIVARIO kit:

This washer-disinfector can be set up or retro-fitted to use the OXIVARIO process by adding an additional dispensing pump and a special buffer tank for hydrogen peroxide (H₂O₂ solution).

The H₂O₂ solution hose is colour coded black.

The DOS 2 dispenser is used for the H₂O₂ solution.

ORTHOVARIO kit:

This washer-disinfector can be retro-fitted to use the ORTHOVARIO process by adding a special dispensing pump to the DOS 4 dispenser in the OXIVARIO system.

- Dispensing system DOS 4 (green) to dispense a special tenside cleaning agent. It can dispense up to 105 ml/min.

If the ORTHOVARIO process is used chemical disinfecting agents cannot be used in the DOS 4 dispenser.

Dispensing liquid chemical agents

Preparing the DOS dispensers

The agents can be filled into 5 l plastic containers, which are colour coded for the relevant dispensing system.

When first commissioning, or when the message FILL DOS 1 CONTAINER and/or FILL DOS 2, 3 or 4 CONTAINER flashes in the display after switching on or at the end of a programme, replace the storage containers with new ones, or refill them with the relevant agent. If the message CHECK DISPENSING SYSTEM 1 and/or CHECK DISPENSING SYSTEM 2, 3 or 4 flashes in the display, check the storage containers, dispensing tubes and hoses. Then replace the storage containers with new ones, or refill them with the relevant agent.

The programme will stop automatically.

When first commissioning or when the message CHECK DISPENSING SYSTEM... appears, start the DOS-FILL Programme to vent the dispensing system (see "Venting the dispensing system").

 Take great care when handling liquid agents and additives. These may contain irritant or corrosive ingredients. Please follow the manufacturer's safety instructions. Wear protective gloves and goggles.

Fill the containers with the relevant agent

- Switch the machine off using the master switch.

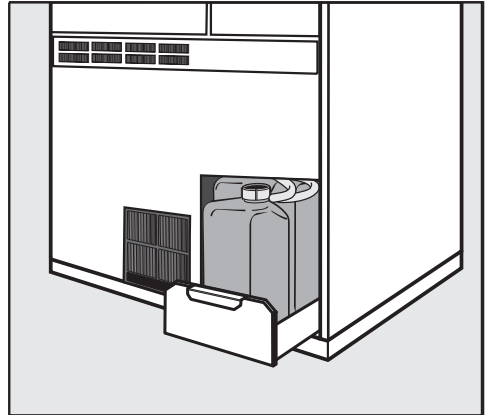

- Lift the service panel up and then drop it forwards and release it from its lower brackets.
- Pull open the drawer to the right of the service panel to access the liquid supply containers.
- Take the storage containers out, open them and fill with the agent required, (observe the colour code).
- Set the service panel onto the lower bracket and then raise it upwards and pressing against the washer-disinfector lower it into position.

Dispensing liquid chemical agents

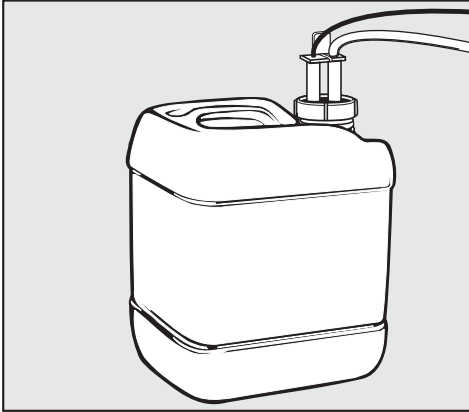

- Insert the siphon tube into the container and screw on securely (observe the colour code).

Once the storage containers have been filled the relevant message goes out.

Please remember to refill containers in good time. Do not let them get empty. It is best to refill them as soon as the FILL DOS 1, 2, 3 or 4 message appears in the display.

If a container is not being used, the level query for the unused dispensing system can be turned off to avoid the error message (see "Machine functions, container query..." in the Programming Manual supplied with the washer-disinfector).

Venting the dispensing system

Before the washer-disinfector is first commissioned, and later on if one or more containers has been allowed to run dry, the dispensing system(s) for liquid media will need to be vented. To do this:

- Press the **I-0** button.
- Select operating level B.
- Select as required:
 - Programme DOS1-FILL
 - Programme DOS2-FILL
 - Programme DOS3-FILL
 - Programme DOS4-FILL.(See "Operation/B. Free programme selection).
- Press the Start button .

The DOS-FILL Service Programmes are allocated to programme places 58-61 ex works, but can be re-allocated to other programme places, if preferred.

Dispensing system maintenance

To ensure trouble-free operation, the following regular maintenance should be carried out by a Miele approved service technician.

Every 12-18 months

Replace the hoses in the dispensing system(s).

External Dispensing systems

If external pumps are to be used for dispensing liquid agents, please inform the Miele Service Department. The instructions given in the Programming Manual under "Machine functions" will need to be observed.

Operation

Master switch

The master switch with "emergency cut-off function" is set to **I-ON**.

Switching on

- Open the stopcocks (if turned off).
- Press the **I-0** button.

In operating levels A, B and D the most recently selected PROGRAMME NAME appears in the display and in operating level C AUTOMATIC MOBILE UNIT RECOGNITION is displayed.

Door lock

The door can only be opened if:

- the electricity supply to the machine is switched on,
- the red (emergency cut out) master switch is in the **I-ON** position,
- the **I-0** On-Off button is pressed in, and
- a cleaning or disinfection programme is not in progress.

To open the door

- Press the  door button, and holding onto the door grip open the door.

To open the door on the **Clean side** (through-feed model), the following conditions must also be met:

- DESIN (disinfection) programmes have been correctly completed,
- or
- the door locking function is active (see "Machine function/Door Interlock" in the Programming manual).

 Do not touch the heating elements under the wide area filter during or directly after the end of a programme. You could burn yourself. They remain hot for some time after the programme has finished.

If the boiler has been programmed to BOILER READY, be particularly careful of hot water and steam when opening the door. Danger of burning or scalding. The inlet to the wash cabinet is located, as viewed from the unclean side, underneath the basket runner on the left hand side.

To close the door

Lift the door upwards and push until it clicks shut.

Operating levels

There are four operating levels available on this machine:

- A = Fixed and free access programmes
- B = Free programme selection
- C = AWK – Automatic mobile unit recognition (programme selection via mobile unit coding) - optional -
- D = Programming / free programme selection / change code (see Programming Manual)

To change operating level:

- Press **<** and **>** at the same time. Operating levels A B C D are shown in the display.
- Select the operating level you want using the **<** or **>** buttons.
- Press **⏏** to confirm selection.
- Enter code when requested by the display.
The code is set ex-works to >0000<.
To enter the code:
 - Press the start button **⏏**, [0000] will appear.
 - Enter numbers using the **+** and **-** buttons.
 - Select number position with the **<** or **>** button.
 - To confirm code press **⏏**.

If you enter the wrong code: FALSE CODE, ENTER AGAIN will appear in the display.

- Close the door.

Selecting or changing your own code

The factory default code can be changed. See "System functions" in the Programming Manual.

Code 1 for levels ABC
Code 2 for levels ABCD

Operation

Starting a programme

See the Programme charts in the Programming Manual supplied with the machine for detailed information and important notes on the standard Miele programmes.

 When processing medical devices, any changes made to programmes or dispensing systems must be documented in a log book kept with the machine in accordance with the Medical Devices directive. The machine's cleaning and disinfecting standards must also be re-validated.

A. Fixed programme

Set up fixed programme(s) once in operating levels B or D and for free access in operating level A (see "System functions, Programmes under A free access" in the Programming Manual).

- Select operating level A.
- Check in the display that the programme shown is the one required.
If several fixed programmes have been made freely accessible, select the one required using the programme selector.
- Press the Start button .

B. Free programme selection

- Select operating level B.

In operating level B there are three ways of selecting a programme.

1. Programme places 1 - 23 can be selected using the Programme selector.

- Turn the programme selector to the required programme.
The programme name will appear in the display.





2. Programmes above place 24 are selected using the  and  keys.

- Turn the programme selector to 24.

- Press  (scrolls forwards) until the required programme is shown.

- Press  (scrolls back) until the required programme is shown.

3. The PROGRAMME SURVEY menu lists all stored programmes. A programme can be selected from this menu. To do so:

- Select Programme Survey with  and confirm with .
- Select a programme using  or .
- Press  to confirm selection.

This exits the Programme Survey, and the selected programme is shown in the display.

After selecting one of the three options above:

- Press the start button . The programme proceeds.

For further information on programme selection see "Operating Level B" in the Programming Manual.

C. AWK – Automatic mobile unit recognition

- Select operating level C.
- Push the coded mobile unit into place.

 Make sure that there are no small metallic objects or instrument parts attracted to the magnetic strip, in particular to the underside of it. Any metallic objects on the strip can result in the coding being incorrectly read.

- Close the door.

 Before starting a programme it is **absolutely essential** to check that the programme shown in the display is the correct one for the mobile unit being used. Otherwise inadequate cleaning or disinfection could be the result. Please make sure, that the places assigned for the programmes using Automatic mobile unit recognition are not changed around arbitrarily.

- Press the Start button .

Programme sequence

The programme will start automatically as soon as the Start button has been pressed. It is finished when PROGRAMME-END appears in the display and the background lighting flashes (press any button to switch off the flashing lights).

See "System functions" in the Programming Manual for further information on switching off the flashing signal.

Detailed information on programme sequences is given in the appendix of the Programming Manual.

The display background lighting goes out automatically after approx. 15 mins. To bring it back on again press one of the buttons.

 On machines with a built-in printer you must not change the colour ribbon cartridge or the paper roll whilst a programme is in progress.

Operation

Switching off

- Press and release the **I-0** button.
- Turn off the stopcocks.

Cancelling a programme

A programme can only be cancelled in operating level B or D.



When testing to EN ISO 15883-1 or HTM 2030 standards, the programme must not be interrupted or cancelled.

In operating levels B or D

- Press the Stop button .

The programme is interrupted. CANCEL or >CONTINUE< will appear in the display.

 With established decontamination programmes any contaminated water must be decontaminated using a disinfecting agent before it is discharged into the sewerage system. The door on the unclean side of the machine can be opened to do this.

- Use cursor  to select >CANCEL<, the > < cursors will start flashing.
- Press the Start button . The programme is cancelled and the water pumped away.

DRAIN WATER appears in the display.

- After the water has been pumped away the required programme can be selected and started again.

Interrupting a programme

A programme can only be interrupted in operating level B or D.

If you absolutely have to open the door, e.g. because the load is obviously unstable (conscious intervention):

After interrupting a DESIN disinfection programme, if you wish to continue it please check the message in the display at the end of the programme. If the message PROCESS PARAMETERS NOT MET is displayed, it means the door was opened **after** the disinfection part of the programme and the DESIN parameters were not fulfilled. If necessary the programme must be repeated.

In operating levels B or D

- Press the Stop button .

The programme is interrupted. CANCEL or >CONTINUE< will appear in the display.

- Open the door.

On barrier machines please note: If the machine is set to WITHOUT DOOR INTERLOCK - YES the doors on either the clean or unclean side can be opened. If it is set to WITHOUT DOOR INTERLOCK - NO only the door on the unclean side can be opened at this stage.

Washer-disinfectors used as medical devices (in accordance with EN ISO 15883) should always be set to WITHOUT DOOR INTERLOCK NO.

 Caution. Water and items in the machine may be hot. Danger of burning or scalding. Where a chemical disinfection programme has been used, be aware that steam may contain high quantities of disinfecting agent.

- Rearrange the load. Follow infection control regulations and wear protective gloves.
- Close the door.
- Press the Start button .

The programme will continue.

Data transfer

Each machine is supplied with a 5 m long interface cable for data transfer between the Profitronic system and an external report printer or PC.

The interface cable is rolled up inside the machine and must only be connected by an authorised Service Dealer or the Miele Service Dept.

The serial interface is RS 232 compatible.

For the interface configurations see "PC/Printer Function" in the Programming manual.

Various printers can be used as external printers:

- Epson-compatible (contact Miele for a list of suitable models).
- HP Laserjet.

Pin configuration in the 9-pole sub-D connector on the interface cable:

- 5 GND (base)
- 3 TXD (transmit)
- 2 RXD (receive)
- 1-4-6 (linked)
- 7-8 (linked)

A standard null-modem or laplink cable can be connected.

The extension cable to the printer/PC must not exceed 10 m in length.

Please note the following when connecting a printer or PC:

- Only use an industry-standard PC or printer (e.g. in Germany TÜV, or VDE approved).
- The size of the printer or PC must be taken into account when installing the machine.

The report printer settings are described in detail in the Programming manual under "PC/Printer function".

Periodic checks

This washer-disinfector should be inspected in accordance with local and national safety regulations after every 1000 operating hours, or every 6 months by a Miele approved service technician.

This maintenance will cover the following:

- Electrical safety tests
- Door mechanism and door seal
- Any screw connections and connectors in the wash cabinet
- Water inlet and drainage
- Internal and external dispensing systems
- Spray arms
- Filter combination
- Sump including drain pump and non-return valve
- Steam condenser
- All mobile units, modules and inserts

and where applicable:

- The drying unit
- Any printer connected to the machine

The following operational tests will be carried out within the framework of the maintenance:

- A programme will be run as a test run
- Thermo electrical measurements will be taken
- Seals will be tested for water tightness
- All relevant measuring systems will be safety tested including error message displays.

Maintenance

Process validation

The standard of cleaning and disinfection in the disinfection programmes must be confirmed by the user as a routine matter.

Safety checks must be carried out to the machine every 3 months by a Miele approved service technician in accordance with EN ISO 15883 and HTM 2030.

Routine checks

Before the start of each working day the user must carry out a number of routine checks. A check list is supplied with the machine for this purpose.

The following need to be inspected:

- All filters in the wash cabinet
- The spray arms in the machine and in any mobile units or modules
- The wash cabinet and the door seal
- Mobile units, modules and inserts

Cleaning the filters in the wash cabinet

The filters in the base of the wash cabinet are designed to prevent coarse soiling getting into the circulation system.

A build-up of coarse soiling can cause the filters to clog up. They should, therefore, be checked daily and cleaned if necessary.

 This machine must not be used without all the filters in place.

 Watch out for glass splinters, needles etc. which could cause injury.

Cleaning the coarse filter

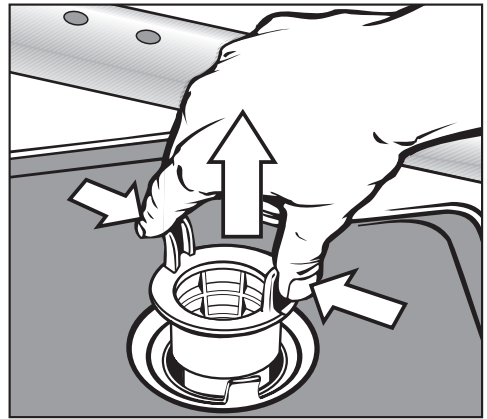

- Press the two lugs together, remove and clean the coarse filter.
- Put the clean filter back in position and press until it clicks in place.

Maintenance

Cleaning the coarse, flat and micro-fine filters

- Remove the coarse filter.
- Remove the fine filter (if fitted) from between the coarse and the micro-fine filters.

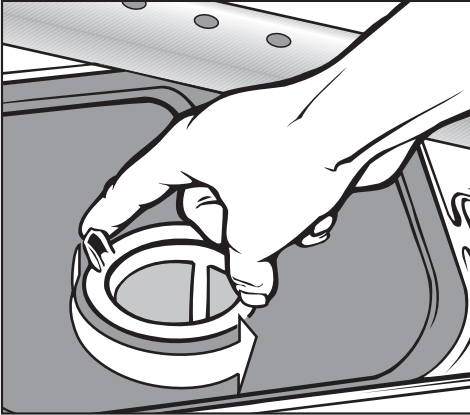

- To unscrew the micro-fine filter, take hold of the two lugs and turn twice in an anti-clockwise direction.

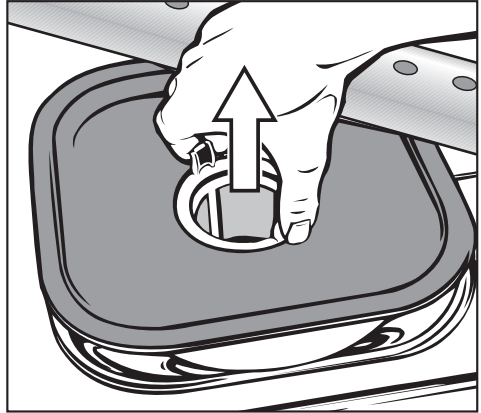

- Then remove together with the flat filter.
- Clean the filters.
- Replace the filters by carrying out the above steps in the reverse order. Ensure that the flat filter sits flat in the base of the wash cabinet.

Cleaning the spray arms

Waste particles can lodge in the spray arm jets. It is therefore important to inspect the spray arms regularly.

Use a sharp pointed object to push particles into the spray arm jets, and rinse well under running water.

- Use a sharp pointed object to push particles into the spray arm jets, and rinse well under running water.

Remove the spray arms as follows:

- Take any mobile units out of the wash cabinet.

Spray arms in the wash cabinet:

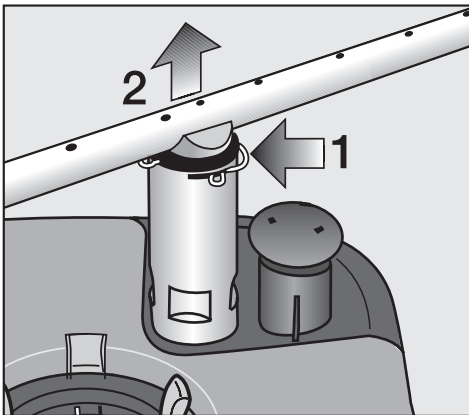

- Loosen the securing clip on the spray arm connection and then pull the spray arm upwards or downwards.

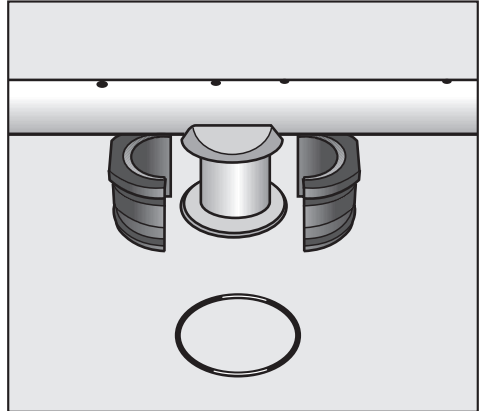

- Remove the seal and the bearing and clean them.
- Refit the bearing and the seal.

Spray arms in mobile units/modules:

- Turn the nut (left hand thread) together with the spray arm clockwise and then pull the spray arm downwards and off.
- After cleaning the spray arms screw them back into position.
- After replacing the spray arms, check that they rotate freely.

Maintenance

Miele offer a range of branded cleaning products. These are available from your Miele retailer, the Spare Parts Department, or via the internet on www.miele-shop.com.

Cleaning the control panel

- The control panel should only be cleaned using a damp cloth or with a proprietary cleaning agent for glass or plastic surfaces. An approved and listed disinfecting agent can be used to wipe surfaces.

 Do not use abrasive cleaners or all-purpose cleaners. Because of their chemical composition they could cause serious damage to plastic components.

Cleaning the front of the machine

- The front should be cleaned using a damp cloth and a little washing-up liquid, or with a non-abrasive proprietary cleaning agent designed for use on stainless steel.
- To help prevent fingermarks etc. a stainless steel conditioning agent can also be used.

 Do not use any cleaning agents containing ammonia or thinners as these can damage the surface material.

 Never clean the machine or near vicinity with a water hose or a pressure washer.

Cleaning the wash cabinet

The wash cabinet is generally self-cleaning.

However, should a build-up of deposits occur in the cabinet please contact the Miele Service Department for advice.

Cleaning the door seals

The door seals should be cleaned regularly with a damp cloth to remove any soiling.

Seals which are no longer tight or which have suffered damage must be replaced with new ones by the Service Department.

Mobile units, modules and inserts

Mobile units, modules and inserts should be checked daily to make sure they are functioning correctly. The washer-disinfector is supplied with a check list.

The following need to be inspected:

- Check that rollers on mobile units/ inserts are free of hindrance and that they are secure.
- Check that the mobile unit connector is at the correct height and screwed on correctly.
- Check that the locking caps in the module connectors of modular system mobile units are working properly.
- Check that jets, sleeves and hose adapters are securely held in position in mobile units/inserts.
- Check that wash liquor can flow unhindered through all jets, sleeves and hose adapters.
- Make sure caps and closures on sleeves are correctly located.

and where applicable:

- Make sure that the spray arms rotate freely.
- Make sure the spray arm jets are free of any blockages. See "Cleaning the spray arms".
- Make sure that there are no small metallic objects sticking to the magnetic strip on a mobile unit.
- Make sure the magnetic strip on mobile units with automatic mobile unit recognition is correctly screwed into position.

Maintenance

Printer (optional)

Renewing the paper roll

Renew the paper roll when the red indicator lights up in the printer.

To do this:

- Open up the front flap on the printer and then open it downwards.
- Take the empty roll together with its spindle from the roller holder, fit the new roll on the spindle and put back in place.
- Guide the paper upwards onto the paper feed roller (slit behind the colour cassette), ensuring that the green paper feed button is kept pressed in until the paper emerges above the cassette.
- Guide through the slit in the front flap, then close the front flap.

Replacement paper rolls (58 mm wide, outer diameter approx. 50 mm) can be purchased from the Miele Spare Parts Department or from an office stationery supplier.

Renewing the colour cassette

- Open up the front flap on the printer and then open it downwards.
- Pull the colour cassette (above the paper roll) forward and out of its holder, then put in a new one. Ensure the paper still passes between the colour ribbon and the cassette.
- Turn the little wheel for manual colour ribbon feed on the right in a clockwise direction until the ribbon is taut.
- Cut the paper at an angle and guide through the slit in the front flap then close the front flap.

Replacement colour ribbon cassettes can be bought from the Miele Spare Parts dept or from an office stationery supplier.

 Repairs should only be carried out by a suitably qualified and trained Miele technician in accordance with local and national safety regulations. Unauthorised or incorrect repairs could cause personal injury or damage the machine.

To avoid unnecessary service call-outs, check that the fault has not been caused by incorrect operation.

An overview of all **error messages** that can appear in the display are given in the Programming manual under "Messages".

If, having followed the advice in the operating instruction manual and in the programming manual, you are still unable to resolve a problem please call the Miele Service Department (see back cover for contact details).



- When contacting Miele, please quote the model and serial number of your machine

These are located on the data plate (see "Electrical connection").

Converting the type of heating

Converting from steam to electric heating or from electric to steam

If your machine is convertible, you can use the STEAM>>ELECTRO or ELECTRO>>STEAM service programme to switch from one type of heating method to the other.

- Select STEAM>>ELECTRO or ELECTRO>>STEAM (see Operation / B. Free programme selection).
- Press the Start button .
When the Service programme has ended, a message will appear in the display.
- To >CONTINUE< press .

All electrical work must be carried out by a suitably qualified and competent person in accordance with local and national safety regulations (BS 7671 in the UK).

- Connection should be made via a suitable isolator with an on-off switch which is easily accessible for servicing after the machine has been installed.
- An electrical safety test must be carried out after installation and after any servicing work. It is therefore essential that the on-off switch is easily accessible.
- When switched off there must be an all-pole contact gap of at least 3 mm in the isolator switch.
- For extra safety it is advisable to protect the machine with a suitable residual current device (RCD).
- Check that the phase rotation is correct when connecting the machine. Failure to do so could have an adverse effect on the circulation pump and impair the wash quality.
- Equipotential bonding should be carried out.
- For technical data see data plate or wiring diagram supplied.

The machine must only be operated with the voltage, frequency and fusing shown on the **data plate**.

Further notes on electrical connection are given on the Installation diagram supplied with the machine.

The **data plate** showing relevant test marks (VDE, DVGW etc.) is located on the cover located behind the service panel on the unclean side of the machine.

The **wiring diagram** is supplied with the machine.

WARNING

**THIS APPLIANCE MUST BE
EARTHED**

Plumbing

 This machine should be connected to the mains water supply and to the drainage system in accordance with local and national water regulations. Please refer to the installation diagram supplied with the machine.

- If the water supply has a high iron content there is a danger of corrosion occurring on items being processed in the machine, as well as in the machine itself.
If the chloride content of the water exceeds 100 mg/l the risk of corrosion to items being processed in the machine will be further increased.

Technical data

| | |
|--|--|
| Height | 1536 mm (incl. 100 mm plinth and lid) 1928 mm (incl. 100 mm plinth and MAV) |
| Width | 90 cm |
| Depth | 77 cm |
| Depth with door open | 133.7 cm |
| Weight (incl. plinth, DKWK and MAV): | Approx. 350 kg |
| Weight in operation | Approx. 500 kg |
| Voltage | See data plate |
| Connected load | See data plate |
| Fuse rating | See data plate |
| Compressed air connection | 600 kPa (6.0 bar) required for steam operation |
| Steam connection (with electric TA): | 250 - 1000 kPa / 140 - 180 °C |
| Water pressure (flow rate) | 100 - 1000 kPa overpressure |
| Water connection: Cold, hot and de-ionised (AD) water | up to max. 70 °C |
| Ambient temperature | 5 °C to 40 °C |
| Relative humidity: maximum decreasing proportionately to | 80 % for temperatures to 31 °C 50 % for temperatures to 40 °C |
| Altitude | Max. 1500 m # |
| Soiling level (according to IEC/EN 61010-1) | P2 |
| Protection category (according to IEC 60529) | IP20 (Dust permeation) |
| Noise level in dB (A), Sound level LpA during cleaning and drying phases | < 70 |
| Test marks | VDE, radio interference suppression |
| CE mark | MDD-Guidelines 93/42/EWG, Class IIb |
| Manufacturer's address | Miele & Cie. KG, Carl-Miele-Str. 29, 33332 Gütersloh, Germany |

If installed at altitudes above 1500 m the boiling point of the suds solution will be lower. Disinfecting temperature parameters should be lowered and the holding time increased (A₀ value). This must be done by a Miele authorised service technician.

Optional extras

Optional extras

- Drying unit (TA)
- Steam condenser (DK)
- Water softener
- Report printer (PRT)
- Dispensing systems DOS 2 and DOS 4
- OXIVARIO kit
- ORTHOVARIO kit (this has to be set up by an approved Miele service technician)

Special processes - OXIVARIO and ORTHOVARIO

Description of the machine

This washer disinfector can be set up or retro-fitted to use the OXIVARIO process by adding two additional dispenser pumps together with a buffer tank for hydrogen peroxide solution H_2O_2 . The DOS 2 dispenser is used for the H_2O_2 solution.

To use the ORTHOVARIO process the DOS 4 dispensing system has to be replaced by a dispenser pump for a tenside based cleaning agent.

The OXIVARIO, OXIVARIO PLUS and the ORTHOVARIO programmes are available for these requirements. The machine is supplied with these programmes allocated to programme places 51 to 53.

The OXIVARIO process releases active oxygen under alkaline conditions. The cleaning agent used must be tenside free and have a pH value of between 11 and 11.5.

The ORTHOVARIO process uses a special tenside based cleaning agent in the first cleaning phase and then releases active oxygen in the second phase with a pH value of between 10.0 and 11.0 and a slightly higher temperature of 65 °C.

Special processes - OXIVARIO and ORTHOVARIO

Areas of application

The **OXIVARIO** procedure has an alkaline main wash making it particularly suitable for the processing of surgical instruments where existing procedures are not satisfactory. It is particularly suitable for instruments such as those used in high frequency surgery, orthopaedic surgery as well as for instruments which have dried out because of the length of time between using them and reprocessing them. It is also suitable for antiseptic circumstances.

The cleaning process is gentle enough for instruments used in minimally invasive surgery, including fibre optics, where the manufacturer has declared that they are suitable for processing with an alkaline cleaning agent.

It is not suitable for anodised aluminium.

Be aware that items made from alloys containing titanium such as some implants, do not always state the material's compatibility. Processing such items can result in colour changes, rendering any coding on them ineffective. If in doubt please consult the manufacturer of the item.

The **ORTHOVARIO** procedure is suitable for processing aluminium instruments which are sensitive to alkalines. It is particularly suitable for orthopaedic instruments including motor systems.

Because of its oxidising effect it must not be used for titanium implants, and in particular colour coded ones.

 Due to the high efficacy of the Oxivario and Orthovario processes it is important to lubricate joints and contact parts on instruments pre sterilisation. Please refer to the instrument manufacturer for guidance.

Warning and Safety instructions

 These warning and safety instructions are in addition to those given at the beginning of this booklet.

▶ H₂O₂ solution must only be used in the special containers and adapters provided by the Ecolab and Dr. Weigert companies.

▶ Important: observe the manufacturer's safety instructions as given on their safety data sheet.

▶ Be especially careful when handling H₂O₂ solution. It is an irritant chemical. Observe all current safety instructions pertaining to its use. Wear protective gloves and goggles.

▶ Empty containers must be disposed of in accordance with the manufacturer's instructions.

▶ H₂O₂ solution must not be mixed with other chemicals. This could cause a serious chemical reaction, e. g. the release of harmful vapours or gases.

▶ Only use tenside cleaning agents supplied by Ecolab or Dr. Weigert.

Connecting the H₂O₂ solution container

The connection hose for the H₂O₂ solution container is identified by a black label. The connection hose is supplied without a safety cap as the container for hydrogen peroxide will vary depending on supplier.

- Connect the supplier's safety cap to the connection hose (black).
- Then connect this to the H₂O₂ solution container.
- Then start the **DOS2-FILL** programme.

Unlike with other chemical agents the H₂O₂ solution container must be fully emptied before it is exchanged for a new one.

Do not replace the H₂O₂ solution container with a new one until the **FILL DOS 2 CONTAINER** message is displayed. After connecting the new container you must run the **DOS2-FILL** programme.

If the **CHECK DISPENSING SYSTEM 2** message appears you should check the container as well as the dispensing system. The programme will stop automatically.

Disposal of your old machine

Electrical and electronic machines often contain materials which, if handled or disposed of incorrectly, could be potentially hazardous to human health and to the environment. They are, however, essential for the correct functioning of your or machine. Please do not therefore dispose of it with your general waste.

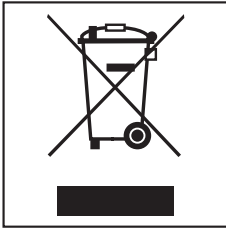

Please dispose of it at your local community waste collection / recycling centre or contact your dealer for advice. Ensure that it presents no danger to children while being stored for disposal.

United Kingdom

Miele Co. Ltd.
Fairacres, Marcham Road
Abingdon, Oxon, OX14 1TW
Tel: 0845 365 0555
Fax: 0845 365 0777
Customer Contact Centre Tel: 0845 365 6600
E-mail: info@miele.co.uk
Internet: www.miele.co.uk

Australia

Miele Australia Pty. Ltd.
ABN 96 005 635 398
1 Gilbert Park Drive, Knoxfield, VIC 3180
Tel: (03) 9764 7130, Fax: (03) 9764 7149
Internet: www.miele.com.au

China

Miele Shanghai
Suite 4105-06, Plaza 66
1266 Nanjing Road West
Jing An District
Shanghai 200040, PRC
Tel: +86 21 6288 4200, Fax: +86 21 6288 4100
E-mail: mieleshanghai@cn.miele.com
Internet: www.miele.cn

Miele (Hong Kong) Limited

41/F - 4101, Manhattan Place
23 Wang Tai Road
Kowloon Bay
Hong Kong
Tel: (852) 2610 1331
Fax: (852) 2610 1013
Email: mielehk@miele.com.hk

India

Miele Appliances India Pvt. Ltd.
Ground Floor, Copia Corporate Suites
Plot No. 9, Jasola
New Delhi - 110025
Tel: 011-46 900 000, Fax: 011-46 900 001
E-mail: customercare@miele.in
Internet: www.miele.in

Germany - Miele & Cie. KG

Carl-Miele-Straße 29, 33332 Gütersloh

Miele

Ireland

Miele Ireland Ltd.
Broomhill Road, Tallaght, Dublin 24
Tel: (01) 461 0710, Fax: (01) 461 07 97
E-Mail: info@miele.ie
Internet: www.miele.ie

New Zealand

Miele New Zealand Limited
Unit L, 10-20 Sylvia Park Road
Mt. Wellington, 1060, Auckland, NZ
Tel: 0800 264 353, Fax: 0800 463 453
Internet: www.miele.co.nz

Singapore

Miele Southeast Asia
Miele Pte. Ltd.
163 Penang Road
04 - 02/03 Winsland House II
Singapore 238463
Tel: +65 6735 1191, Fax: +65 6735 1161
E-Mail: infosea@miele.com.sg
Internet: www.miele.sg

South Africa

Miele (Pty) Ltd
63 Peter Place, Bryanston 2194
P.O. Box 69434, Bryanston 2021
Tel: +27 (0) 11 548-1900
Fax: +27 (0) 11 548-1935
E-mail: info@miele.co.za
Internet: www.miele.co.za

United Arab Emirates

Miele Appliances Ltd.
P.O. Box 11 47 82
Gold & Diamond Park
Sheikh Zayed Road
Building 6 / Offices Nos. 6-214 to 6-220
Dubai
Tel: +971-4-341 84 44
Fax: +971-4-341 88 52
E-Mail: info@miele.ae
Internet: www.miele.ae