



WASHER USER'S GUIDE

TABLE OF CONTENTS

Welcome	Inside Cover
Safety Instructions	1
Controls At A Glance	2-5
Water Use	5
Features	6-7
Care and Cleaning	8
Cleaning the Dispenser	8
Storing the Washer	9
Replacing Interior Light	9
Reversing the Door	9
Before You Call	10-11
Operating Sounds	12
Questions & Answers	13
Warranty	Back Page



Welcome.....



Welcome and congratulations on your purchase of a Maytag Neptune™ washer. Your complete satisfaction is very important to us.

Read this manual for best results. It contains instructions to acquaint you with proper operating and maintenance procedures.

In addition you will find a *Laundering Tips* guide packed with your clothes washer. It contains information on recommended laundering procedures, stain removal and special laundering situations.

Save time and money. If something should go wrong, we suggest consulting the “Before You Call” section in the back of this book. It is designed to help you solve basic problems before consulting a servicer.



However, should you need assistance in the future, it is helpful to:

1) Have complete model and serial number identification of your washer. This is located on a data plate on the center top edge of the control panel. Record these numbers below for easy access.

Model Number

Serial Number

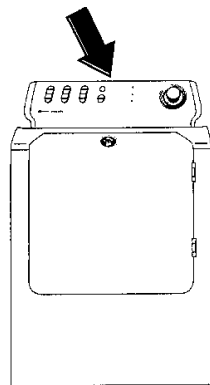

2) **IMPORTANT:** *Keep this guide and the sales receipt in a safe place for future reference. Proof of original purchase date is needed for warranty service.*

Please attach your sales receipt here.

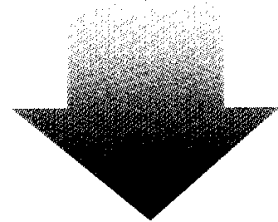

If you have questions, write us (include your model number and phone number) or call:

Maytag Appliances Sales Company
Attn: CAIR® Center
P.O. Box 2370
Cleveland, TN 37320-2370
1-888-462-9824 USA & CANADA
1-800-688-2080 USA TTY (for deaf, hearing impaired or speech impaired)
(Mon.–Fri., 8am–8pm Eastern Time)
Internet: <http://www.maytag.com>

For service and warranty information, see back page.

NOTE: *In our continuing effort to improve the quality of our appliances, it may be necessary to make changes to the appliance without revising this guide.*

Important Safety Instructions

⚠ WARNING — To reduce the risk of fire, explosion, electric shock, property damage or injury to persons when using your appliance, follow basic precautions, including the following:

1. Read all instructions before using the appliance.
2. As with any equipment using electricity and having moving parts, there are potential hazards. To use this appliance safely, the operator should become familiar with the instructions for operation of the appliance and always exercise care when using it.
3. Do not install or store this appliance where it will be exposed to the weather.
4. Install and level the clothes washer on a floor that can support the weight.
5. This appliance must be properly grounded. Never plug the appliance cord into a receptacle which is not grounded adequately and in accordance with local and national codes. See installation instructions for grounding this appliance.
6. To avoid the possibility of fire or explosion:
 - a. Do not wash items that have been previously cleaned in, washed in, soaked in, or spotted with gasoline, dry-cleaning solvents, other flammable or explosive substances as they give off vapors that could ignite or explode. Hand wash and line dry any items containing these substances.

Any material on which you have used a cleaning solvent, or which is saturated with flammable liquids or solids, should not be placed in the clothes washer until all traces of these liquids or solids and their fumes have been removed.

These items include acetone, denatured alcohol, gasoline, kerosene, some liquid household cleaners, some spot removers, turpentine, waxes and wax removers.
 - b. Do not add gasoline, dry-cleaning solvents, or other flammable or explosive substances to the wash water. These substances give off vapors that could ignite or explode.
 - c. Under certain conditions, hydrogen gas may be produced in a hot water system that has not been used for 2 weeks or more. **HYDROGEN GAS IS EXPLOSIVE.** If the hot water system has not been used for such a period, before using a washing machine or combination washer-dryer, turn on all hot water faucets and let the water flow from each for several minutes. This will release any accumulated hydrogen gas. As the gas is flammable, do not smoke or use an open flame during this time.
7. Unplug power supply cord before attempting to service your clothes washer.
8. Do not reach into the appliance if the tumbler is moving.
9. Do not allow children to play on or in the appliance. Close supervision of children is necessary when the appliance is used near children.
10. Do not tamper with controls.
11. Do not repair or replace any part of the appliance or attempt any servicing unless specifically recommended in published user-repair instructions that you understand and have the skills to carry out.
12. Store laundry aids and other material in a cool, dry place where children cannot reach them.
13. Do not wash or dry items that are soiled with vegetable or cooking oil. These items may contain some oil after laundering. Due to the remaining oil, the fabric may smoke or catch fire by itself.
14. Do not use chlorine bleach and ammonia or acids (such as vinegar or rust remover) in the same wash. Hazardous fumes can form.
15. Do not machine wash fiberglass materials. Small particles can stick to fabrics washed in following loads and cause skin irritation.
16. Before the appliance is removed from service or discarded, remove the door to the washing compartment.
17. Do not sit on top of the clothes washer.

Save These Instructions



Controls At A Glance

For detailed information on sorting, pretreating stains, etc., see the enclosed Laundering Tips booklet.

Step 1 Load the Clothes Washer

- The tub can be loaded completely full with dry unfolded clothes. However, do not pack the tub tightly.
- Overloading may reduce washing efficiency and possibly cause creasing or wrinkling of the load.
- When washing big bulky items or a couple of small items that do not fill the tub completely, such as a rug or two sweaters, a few towels should be added for improved tumbling and spin performance.
- When washing heavily soiled loads, it is very important to avoid overloading the washer to assure good cleaning results.
- **To load a forgotten item immediately after the clothes washer has started,** press the START/STOP button. The door will remain unlocked for approximately 3 minutes into the start of the cycle. Add the item(s), close the door and press the START/STOP button to resume the cycle.
- **Once the door has locked, it is possible to load a forgotten item.** Press the START/STOP button and wait approximately 2 minutes for the "Door Locked" indicator to turn off. Open the door, add the item(s), close the door and press the START/STOP button to resume the cycle.

Step 2 Select Fabrics

Press the appropriate button for the type of load. This will determine the tumble/pause pattern and spin speed for the cycle.

FABRIC SELECTION	LOAD TYPE	DESCRIPTION
WHITES	Towels Jeans Sheets	Linens Underwear T-shirts
COLORS	Dress shirts/pants Wrinkle Free clothing Poly/cotton blend clothing	Normal tumble pattern and high speed spin.
DELICATES	Dress skirts/blouses Nylons Sheer or lacy garments	Reduced tumble pattern and spin speed to reduce wrinkling.
HAND WASHABLES	Hand-Washables	Gentle tumble action and gentle spin speed.
		Alternating periods of short and long soak and gentle spin speed.



Controls At A Glance

For detailed information on sorting, pretreating stains, etc., see the enclosed Laundering Tips booklet.

Step 1 Load the Clothes Washer

- The tub can be loaded completely full with dry unfolded clothes. However, do not pack the tub tightly.
- Overloading may reduce washing efficiency and possibly cause creasing or wrinkling of the load.
- When washing big bulky items or a couple of small items that do not fill the tub completely, such as a rug or two sweaters, a few towels should be added for improved tumbling and spin performance.
- When washing heavily soiled loads, it is very important to avoid overloading the washer to assure good cleaning results.
- **To load a forgotten item immediately after the clothes washer has started,** press the START/STOP button. The door will remain unlocked for approximately 3 minutes into the start of the cycle. Add the item(s), close the door and press the START/STOP button to resume the cycle.
- **Once the door has locked, it is possible to load a forgotten item.** Press the START/STOP button and wait approximately 2 minutes for the "Door Locked" indicator to turn off. Open the door, add the item(s), close the door and press the START/STOP button to resume the cycle.

Step 2 Select Fabrics

Press the appropriate button for the type of load. This will determine the tumble/pause pattern and spin speed for the cycle.

FABRIC SELECTION	LOAD TYPE	DESCRIPTION
WHITES	Towels Jeans Sheets	Linens Underwear T-shirts
COLORS	Dress shirts/pants Wrinkle Free clothing Poly/cotton blend clothing	Normal tumble pattern and high speed spin.
DELICATES	Dress skirts/blouses Nylons Sheer or lacy garments	Reduced tumble pattern and spin speed to reduce wrinkling.
HAND WASHABLES	Hand-Washables	Gentle tumble action and gentle spin speed.
		Alternating periods of short and long soak and gentle spin speed.

Step 3 Select Wash/Rinse Water Temperatures

Press the appropriate button to select the wash and rinse water temperatures. Follow the garment care label and chart below for best results.

WASH/RINSE TEMPS	LOAD TYPE
HOT COLD	Whites Heavily soiled color-fast items
WARM WARM	Color-fast items. When warm rinse is selected, only the third rinse will be warm. The first and second rinses will be cold to conserve energy. <i>NOTE: The warm rinse option is not available with the COLORS fabric selection.</i>
WARM COLD	Wrinkle Free items Color-fast items
COLD COLD	Brightly colored items Washable woolsens

IMPORTANT: The washer features an automatic temperature control to provide a warm wash of approximately 105° F and cold wash of approximately 70° F.

While the washer is filling, you may notice hot and cold water going through the dispenser when cold or warm wash temperatures are selected. This is a normal function of the automatic temperature control feature as the washer determines the temperature of the water.

Step 4 Select Options

Press the appropriate button(s) to select one or more options.

OPTION	USE
MAX EXTRACT	Use for jeans, towels, and bedding. Removes more water from loads during spin. <i>NOTE: To minimize wrinkling of Wrinkle Free fabrics, using the Max Extract option with these loads is not recommended.</i>
EXTRA RINSE	A fourth rinse at the end of the cycle to more completely remove laundry additives and perfumes.
STAIN CYCLE	Adds time to the wash and rinses for better stain removal. Automatically provides a fourth rinse.
RESET ▶	Cancels any or all previously selected options.

Step 5 Select the Signal

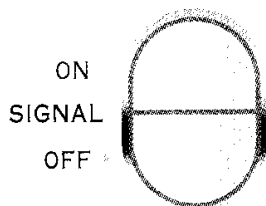

Press ON or OFF for the desired signal option. ON provides an audible signal upon completion of a cycle. OFF provides no audible signal.

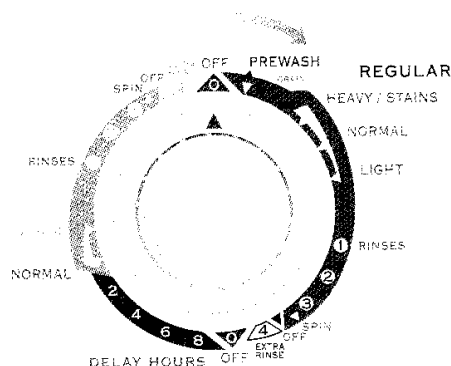

Rotate the control dial clockwise to the desired cycle.

Step 6 Select Cycle

CYCLES	APPROX. CYCLE TIME	DESCRIPTION
REGULAR	<i>The cycles located within the "Regular" area of the dial are used with most loads.</i>	
<i>Prewash</i>	69 minutes	Use for heavily soiled loads. Use 1½ times the usual amount of detergent because the washer drains and refills with fresh water.
<i>Heavy/Stains</i>	59 minutes	Use with STAIN CYCLE option button for heavily soiled, stained loads. NOTE: The HEAVY/STAINS setting is not recommended for use with Delicate or Hand-Washable loads.
<i>Normal</i>	39 minutes	Use for cleaning moderately soiled loads.
<i>Light</i>	33 minutes	Use for cleaning lightly soiled loads.
QUICK	33 minutes	QUICK cycle setting on the left side of the control offers the opportunity to easily set the washer for a quick cycle time for lightly soiled loads.
NORMAL	39 minutes	NORMAL cycle setting on the left side of the control provides a NORMAL cycle when setting the washer for a delay start.
DELAY HOURS	2 – 8 hours	Allows the start of the NORMAL cycle to be delayed for up to 8 hours. Set control dial on the desired number of delay hours, press the START/STOP button. NOTE: If the washer door is opened during the delay time, press START/STOP button again.

Step **7** Start Your Maytag Neptune™ Washer

- Close the door.
- Add detergent and additives to the dispenser (See page 6).
- Push the **START/STOP** button.

START/STOP



When the cycle is complete, the control will point to OFF, and the “DOOR LOCKED” light will go out. The door will open easily. DO NOT attempt to open the washer door when the “DOOR LOCKED” light is illuminated.

Indicator Lights

- **DOOR LOCKED** – Lights whenever the door of the clothes washer is locked. The door can be unlocked by pressing the START/STOP button to stop the clothes washer. **It may take approximately 2 minutes for the door to be unlocked.**
- **ON** – Indicates when the clothes washer is operating.
- **DELAY** – Indicates the washer is counting down the time until it begins to wash.

● DOOR
LOCKED

● ON

● DELAY



Water Use

The amount of water used will vary with each load. The Maytag Neptune™ clothes washer uses an adaptive fill valve to provide the appropriate amount of water for

efficient cleaning performance and conservation of water and energy.

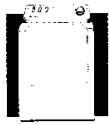

Features

Detergent

Your Maytag Neptune™ washer is designed to use either high efficiency (HE) detergents or regular detergents normally used with top-loading washers.



- For best cleaning results, use a high efficiency detergent such as Tide HE or Wisk HE*. High efficiency detergents contain suds suppressors which reduce or eliminate suds. When less suds are produced, the load tumbles more efficiently and cleaning results are maximized.
- When using regular detergent formulated for top-loading washers, it is important to pay close attention to the soil level of the load, load size, and water hardness**. To avoid over-sudsing, reduce the amount of detergent used with soft water or with small or lightly soiled loads.

If using the "PREWASH" setting, measure 1 1/2 times the amount of detergent.

* Brand names are trademarks of the respective manufacturers.
 ** To determine water hardness in your area, contact your local water utility or State University Extension office in your area.

Automatic Dispenser

The automatic dispenser consists of three compartments which hold 1) liquid or granular detergent and color safe bleach, 2) liquid chlorine bleach and 3) liquid fabric softener. All laundry products can be added at once in their respective dispenser compartments. They will be dispensed at the appropriate time for most effective cleaning.

After loading the laundry additives into the dispenser, close the dispenser lid.

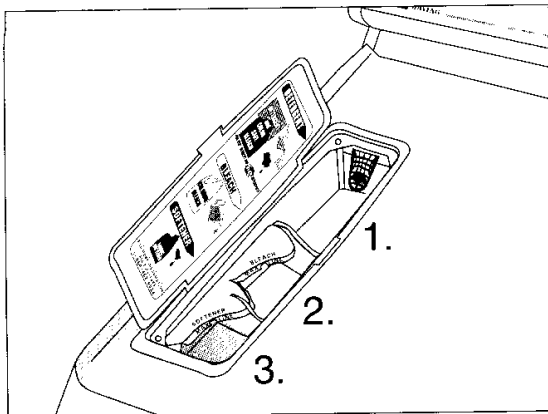

Detergent Compartment

1. Pour laundry detergent directly into the detergent compartment **before** starting the clothes washer.
 2. If color-safe bleach is to be used, it should be added with detergent to the detergent compartment for best results.
- When adding color-safe bleach with detergent, it is best if both laundry products are in the same form: granular or liquid.

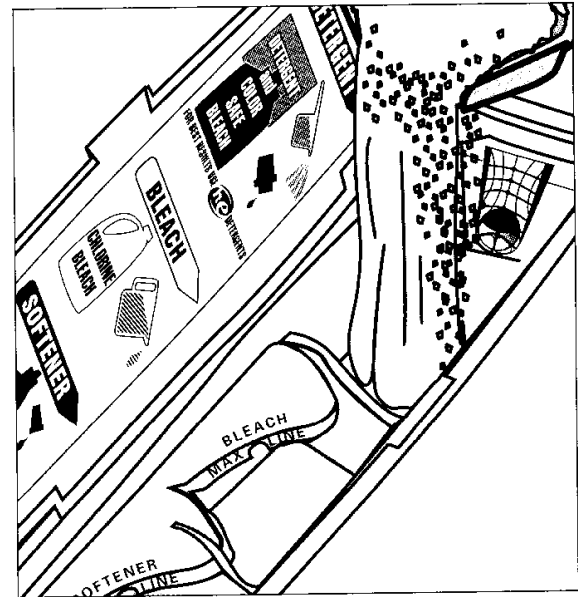

Bleach Compartment (Chlorine Bleach Only)

1. Add chlorine bleach to the bleach compartment. **DO NOT** exceed the **MAX FILL** line. The chlorine bleach compartment will hold 3/4 of a cup.
2. Avoid splashing or over-filling the compartment. **Over-filling the compartment will release the chlorine bleach into the clothes washer too early.**
3. The washer automatically dispenses bleach into the tub when there are approximately two minutes left in the wash portion of the cycle. This maximizes the effectiveness of the bleach.
4. The dispenser automatically dilutes liquid chlorine bleach before it reaches the wash load.

NOTE:

- Never pour undiluted liquid chlorine bleach directly onto the load or into the tub. It is a powerful chemical and can cause fabric damage, such as weakening of the fibers or color loss, if not used properly.
- If you prefer to use color-safe, non-chlorine bleach, add it to the detergent compartment. **Do not pour color-safe bleach into the bleach compartment.**

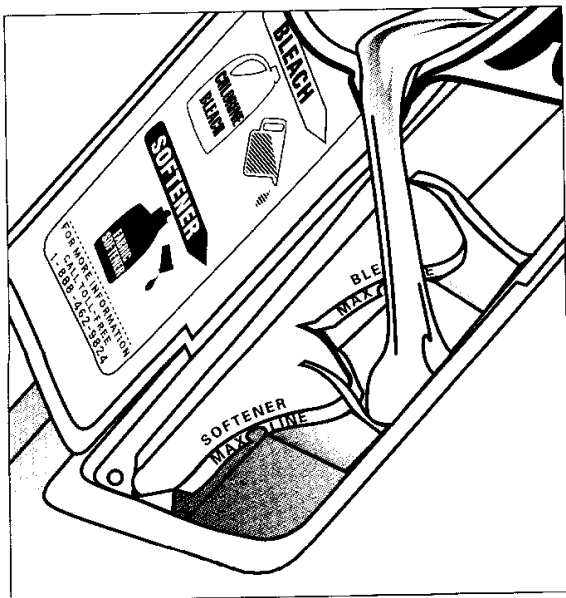

Softener Compartment

1. Pour the recommended amount of liquid fabric softener into the softener compartment. For smaller loads use less than one cap full.
2. Fabric softener may be diluted with warm water until it reaches the **MAX FILL** line on the compartment. **Do not dilute the liquid fabric softener compartment above the MAX FILL line. If the compartment is filled above the MAX FILL line, fabric softener will enter the clothes washer too early.**
3. This compartment automatically dilutes and releases liquid fabric softener at the proper time during the rinse cycle.

NOTE:

- Use the softener compartment only for liquid fabric softeners.
- Using the Downy Ball* is not recommended with this washer. It will not add fabric softener at the appropriate time. Use the dispenser on top of the washer.



* Brand names are trademarks of the respective manufacturers.



Care and Cleaning.....

Turn off the water faucets after finishing the day's washing. This will shut off the water supply to the clothes washer and prevent the unlikely possibility of damage from escaping water.

Use a soft cloth to wipe up all detergent, bleach or other spills as they occur.

Clean the following as recommended:

Control Panel – clean with a soft, damp cloth and glass cleaner. Do not use abrasive powders or cleaning pads.

Cabinet – clean with soap and water.

Interior – hard water deposits may be removed, if needed, using a recommended cleaner labeled cloth washer safe.

Cleaning the Dispenser

The dispenser may need to be cleaned periodically due to laundry additive build-up. For easy clean-up of the dispenser, grasp the removable two-compartment container (for bleach and softener) as shown in illustration #1. As you begin to lift the two-compartment container, tilt slightly inward, according to illustration #2 and remove from the main dispenser.

bleach and softener. Run warm water and a soft brush over the cloth over the two parts to remove any excess laundry additives.

Clean the main dispenser area using water and a soft cloth. Once the main dispenser is clean, follow the illustrations in reverse order to replace the two compartment container to its original location.

Once the two-compartment container is removed from the main dispenser, take it to a sink. Follow illustration #3 to remove the cap covering the siphon tube for the

NOTE: Do not use any cleaning substance but water in the main dispenser because it is possible for cleaning substances to drain into the tub. If this should happen, set the washer for a rinse and spin cycle to remove any cleaning substance from the washer before doing a load of laundry.

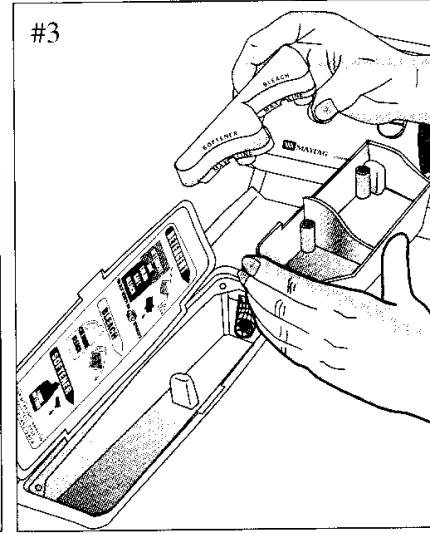
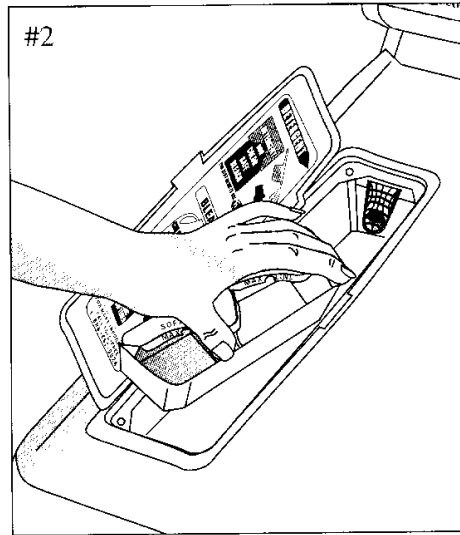
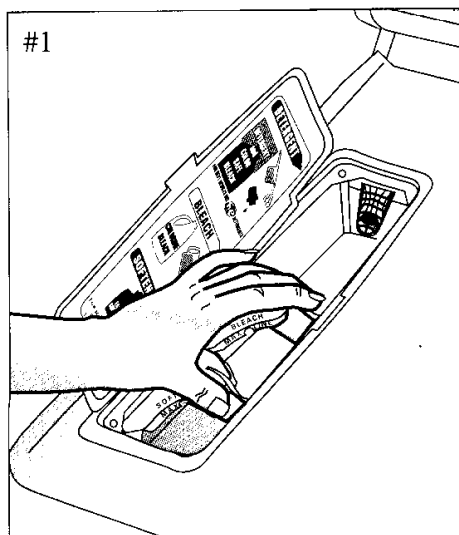



Storing the Clothes Washer.....

Washers can be damaged if water is not removed from hoses and internal components before storage. Prepare the washer for storage as follows:

- Select the "NORMAL" setting on the REGULAR cycle of the clothes washer and add one cup of bleach to the detergent dispenser without clothes in the tumbler. Run the clothes washer through a complete cycle.
- Turn the water faucets off and disconnect the inlet hoses.
- Advance the cycle control knob to Spin and lower the drain hose to eliminate any water that may be in the drain hose.
- Disconnect the clothes washer from the electrical supply and leave the washer door open to let air circulate inside the tumbler.

*For information on long-term storage or storage of your washer during extreme cold temperatures, call Maytag Customer Service toll-free at 1-888-462-9824.
U.S. customers using TTY for deaf, hearing impaired or speech impaired, call 1-800-688-2080.*



Replacing Interior Light

Instructions for replacing the bulb:

- 1) **Unplug or disconnect the clothes washer from the electrical power supply.**
- 2) Open the door and use a Phillips screwdriver to remove the screw attaching the light cover to the door lock assembly.
- 3) Pull down on the light cover.
- 4) Unscrew the light bulb counter clockwise from the socket.
- 5) Replace the bulb with a **10 watt** candelabra base light bulb and rotate clockwise.
- 6) Replace the light cover by inserting the front tabs into the door lock assembly. Push the rear of the light cover into position.
- 7) Replace the screw into the light cover/door lock assembly.
- 8) Plug in or reconnect clothes washer to the power supply.



Reversing the Clothes Washer Door.....

Clothes washer door swing direction can be changed using the following procedure:

- 1) Swing door fully open and support it while removing four hinge screws (which hold hinges to door assembly).
- 2) Set door aside and transfer four color matched door screws to the opposite side of the door assembly.
- 3) Remove one screw holding top hinge to cabinet and one screw holding top hinge cover to cabinet (opposite side).
- 4) Remove hinge and bracket from cabinet by moving them up and down to a position where they are released.
- 5) Install hinge and bracket in swapped locations and drive screws to attach them securely to the cabinet.
- 6) Compare top hinge and top bracket to bottom hinge and bottom bracket for correct assembly position.
- 7) Repeat procedures 4 through 6 for bottom hinge to cabinet and bottom bracket to cabinet.
- 8) Support door in fully open position on hinge side and drive four screws to securely attach hinges to door assembly.
- 9) Close door and check to see that clothes washer operates properly.

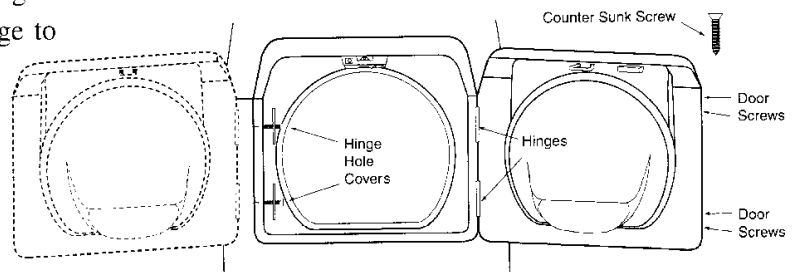



Before You Call

For problem laundry solutions (i.e. fabric damage, residue, tangling) and special laundry care procedures, see the enclosed Laundering Tips booklet.

Check these points if your Maytag Neptune™ washer...

Load Is Too Wet at End of Cycle

- Use Max Extract option.
- Try using a high efficiency detergent to reduce sudsing.
- Load is too small. Very small loads (one or two items) may not spin out completely.

Leaks Water

- Door firmly closed.
- Make sure hose connections are tight.
- Make sure end of drain hose is correctly inserted and secured to drain facility.
- Avoid overloading.
- Use high efficiency detergent to prevent over-sudsing.

Won't Spin or Drain

- Check fuse or reset circuit breaker.
- Straighten drain hoses. Eliminate kinked hoses. If there is a drain restriction, call for service.
- Close the door and push the START/STOP button. For your safety, washer will not tumble or spin unless the door is closed.
- After pressing the START/STOP button, it may take a few moments before the clothes washer begins to spin. The door must lock before spin can be achieved.
- See "Tub is Completely Full of Suds" below.

Stops

- Plug cord into live electrical outlet.
- Check fuse or reset circuit breaker.
- Turn the control dial to proper cycle and push the START/STOP button to start the clothes washer. If equipped with buttons, be sure they are fully depressed.
- Close door and push the START/STOP button to start the clothes washer. For your safety, washer will not tumble or spin unless door is closed.
- This may be a pause or soak period in the cycle. Wait briefly and it may start.
- Check screens on inlet hoses for obstructions. Clean screens periodically.

Tub is Completely Full of Suds

- Run the clothes washer through another complete cycle using cold water.
- Reduce detergent amount for that specific load size, soil level and water hardness.
- Use high efficiency or low sudsing detergent specially formulated for front load washers.

Fills with the Wrong Temperature Water

- Turn both faucets on fully.
- Check that the temperature selector button is fully depressed.
- Make sure temperature selection is correct.
- Make sure hoses are connected to correct faucets and inlet connections. Flush water line before filling washer.
- Check the water heater. It should be set to deliver a minimum 120°F (49°C) hot water at the tap. Also check water heater capacity and recovery rate.
- Disconnect hoses and clean screens. Hose filter screens may be plugged.
- When warm rinse is selected, only the final rinse will be warm. The first two rinses will be cold.
- While the washer is filling for cold or warm wash temperatures, both hot and cold water will go through the dispenser as the automatic temperature control feature checks incoming water temperatures. This is normal.

Check these points if your Maytag Neptune™ washer...

<p>Cycle Selector Knob Advances Through “OFF”</p>	<ul style="list-style-type: none"> • Extra rinse option is selected. • Washer will automatically provide an extra rinse when HEAVY/STAINS cycle and the STAIN CYCLE option button are selected.
<p>Won't Fill</p>	<ul style="list-style-type: none"> • Be sure the door is tightly closed. • Plug cord into a live electrical outlet. • Check fuse or reset circuit breaker. • Turn the control dial to the proper cycle and push the START/STOP button. If equipped with buttons, be sure they are fully depressed. • Make sure the control dial is set on a cycle starting point. Advance the dial slightly. • Turn both faucets on fully. • Straighten inlet hoses. • Disconnect hoses and clean screens. Hose filter screens may be plugged. • Open and close the door, then push the START/STOP button.
<p>Won't Tumble</p>	<ul style="list-style-type: none"> • Check fuse or reset circuit breaker. • Turn the control dial to proper cycle and push the START/STOP button. If equipped with buttons, be sure they are fully depressed. • Close the door and push the START/STOP button. For your safety, the clothes washer will not tumble or spin unless the door is closed.
<p>Door Locked Shut; Will Not Open</p>	<ul style="list-style-type: none"> • Press the START/STOP button to stop the machine. • It may take 1 1/2 to 2 minutes for the door lock mechanism to disengage. • When “Door Locked” light goes out, pull on the door indentation opposite the hinges.
<p>Freshening Your Washer</p>	<ul style="list-style-type: none"> • Open the door and wash the lower portion of the gray door seal with a solution of 1 cup chlorine bleach to 2 cups water. • Select the following control panel setting: WHITES, Hot/Cold, Regular/Heavy/Stains cycle. • Fill the bleach dispenser cup with liquid chlorine bleach and start the washer. • Pour an additional 1/2 cup bleach into the detergent dispenser as the washer is filling. • Allow the washer to complete the cycle. • At the end of the cycle, open the door and dry the gray door seal.
<p>Is Noisy</p>	<ul style="list-style-type: none"> • Clothes washer should be leveled properly as outlined in installation instructions. • Check the leveling leg lock nuts are tightened. • Be sure rubber feet are installed on leveling legs. • Weak floors can cause vibration and walking. • For information on normal operating sounds, see page 12.

For further assistance, call Maytag Customer Service toll-free at 1-888-4-MAYTAG (1-888-462-9824). U.S. customers using TTY for deaf, hearing impaired or speech impaired, call 1-800-688-2080.



Operating Sounds.....

Normal operating sounds of your Maytag Neptune™ clothes washer

"Humming" sound during pre-wash, wash and rinse	The internal pump will intermittently turn on and off.
High pitch sound during a spin cycle.	The motor increases speed to spin the tub to remove moisture from the load.
Flushing water sound coming from the dispenser area.	Detergent is dispensed at the start of the cycle. Bleach is dispensed during final minutes of wash. Fabric softener is dispensed during the third rinse while the washer is filling.
Sloshing or gurgling water sound when washer is off and the tub is rotated.	The sealed balance ring around the tub contains a liquid and is designed to make the washer run smoothly.
"Whirring" or "Sloshing" sound followed by a pause, repeated throughout the wash cycle.	The tub rotates one direction followed by a pause. The tub reverses direction and pauses. This action continues throughout the cycle.
Clothes washer maintains a slightly reduced spin speed after achieving a higher spin speed.	After reaching the maximum spin speed, the machine may reduce spin speed slightly to create less noise and vibration.
The spin speed slows down dramatically when it sounds like an out-of-balance load.	The tumbler will begin to accelerate to speed, then slows back down to redistribute the load more evenly when an unbalanced load occurs.
Water is added after the washer has been tumbling for a while.	The Maytag Neptune™ clothes washer uses a true adaptive fill and adds more water during the wash cycle as it is needed. OR Water flows through the dispenser to dilute and add bleach or fabric softener at the appropriate time. This will occur even if bleach and fabric softener are not used.



Questions & Answers

Q. What's the best cycle to use if I have stains on my laundry?

- A. Select the STAIN CYCLE option button and set the control dial on the HEAVY/STAINS setting. Pretreat the stains with a laundry pre-treat product. Refer to the enclosed Laundering Tips booklet for more information on treating specific stains.

Q. How large of a load can I wash in my Maytag Neptune™ washer?

- A. The tub can be loaded completely full with dry, unfolded clothes. However, do not pack the tub tightly. If the load is heavily soiled it is very important not to overload the washer.

Q. At the end of the cycle my load comes out wetter than normal.

- A. During tumble and spin the washer may have had difficulty getting to a full spin speed because the load was not evenly distributed. This can occur with small loads, heavy items or a load in which too much detergent was used, causing over-sudsing.

Q. My laundry items seem to be very wrinkled at the end of the cycle. What can I do to correct the problem?

- A. Wrinkling is caused by the combination of heat and pressure. Be sure wrinkle free or permanent press fabrics are washed on the COLORS or DELICATES cycle, and a cold rinse is used. (See pg. 3 for WASH/RINSE Temperature). DO NOT USE MAX-EXTRACT.

Q. My whites are not as white as I'd like. What can I do?

- A. Wash white loads using the WHITES fabric selection. Select the hot wash/cold rinse temperature setting and put 3/4 cup of chlorine bleach in the bleach dispenser. The bleach will be dispensed in the final minutes of the wash providing for optimal whitening. Maytag recommends a hot water wash temperature of 120-140° F (49° - 60° C).



Maytag® Neptune™ Washer Warranty

Full One Year Warranty

For one (1) year from the date of original retail purchase, any part which fails in normal home use will be repaired or replaced free of charge.

Limited Warranty

After the first year from date of original retail purchase, through the time periods listed below, the parts designated below which fail in normal home use will be repaired or replaced free of charge for the part itself, with the owner paying all other costs, including labor, mileage and transportation.

Second Year – All parts.

Third through Tenth – The drive motor.

Third through Lifetime – Stainless steel inner wash basket.

Additional Limited Warranty Against Rust-Through

Should an exterior cabinet, including the top and baseframe, rust through during the one year period starting from the date of retail purchase, repair or replacement will be made free of charge. After the first, and through the tenth year, repair or replacement will be made free of charge for the part itself, with the owner paying all other costs, including labor, mileage and transportation.

Please Note: This full warranty and the limited warranty apply when the washer is located in the United States or Canada. Washers located elsewhere are covered by the limited warranty only, including parts which fail during the first two years.

The specific warranties expressed above are the **ONLY** warranties provided by the manufacturer. This warranty gives you specific legal rights, and you may also have other rights that vary from state to state.

To Receive Warranty Service

To locate an authorized service company in your area contact the Maytag dealer from whom your appliance was purchased; or call Maytag Appliances Sales Company, Maytag Customer Assistance at the number listed below. Should you not receive satisfactory warranty service, please call or write:

Maytag Appliances Sales Company
Attn: CAIR® Center
P.O. Box 2370
Cleveland, TN 37320-2370
U.S. or Canada (toll-free) 1-888-462-9824
U.S. customers using TTY for deaf, hearing impaired or speech impaired, call 1-800-688-2080.

When contacting Maytag Appliances Sales Company, Maytag Customer Assistance about a service problem, please include the following:

- (a) Your name, address and telephone number;
- (b) Model number and serial number (found on the back center of the control panel) of your appliance;
- (c) Name and address of your dealer and the date the appliance was purchased;
- (d) A clear description of the problem you are having.
- (e) Proof of purchase.

What is not covered by these warranties:

1. Conditions and damages resulting from any of the following:
 - a. Improper installation, delivery, or maintenance.
 - b. Any repair, modification, alteration or adjustment not authorized by the manufacturer or an authorized servicer.
 - c. Misuse, abuse, accidents, or unreasonable use.
 - d. Incorrect electric current, voltage or supply.
 - e. Improper setting of any control.
2. Warranties are void if the original serial numbers have been removed, altered, or cannot be readily determined.
3. Light bulb
4. Products purchased for commercial or industrial use.
5. The cost of service or service call to:
 - a. Correct installation errors.
 - b. Instruct the user on proper use of the product.
 - c. Transport the appliance to the servicer.
6. Consequential or incidental damages sustained by any person result of any breach of these warranties.

Some states do not allow the exclusion or limitation of consequential or incidental damages, so the above exclusion may not apply.

User's Guides, service manuals and parts information are available from Maytag Appliances Sales Company, Maytag Customer Assistance.

MAYTAG • One Dependability Square • Newton, Iowa 50208