

KitchenAid[®]

Installation Instructions

Washer

IMPORTANT:
Read and save
these instructions.

IMPORTANT

Installer: Leave Installation Instructions
with the homeowner.

Homeowner: Keep Installation Instructions
for future reference.

Save Installation Instructions for local
electrical inspector's use.

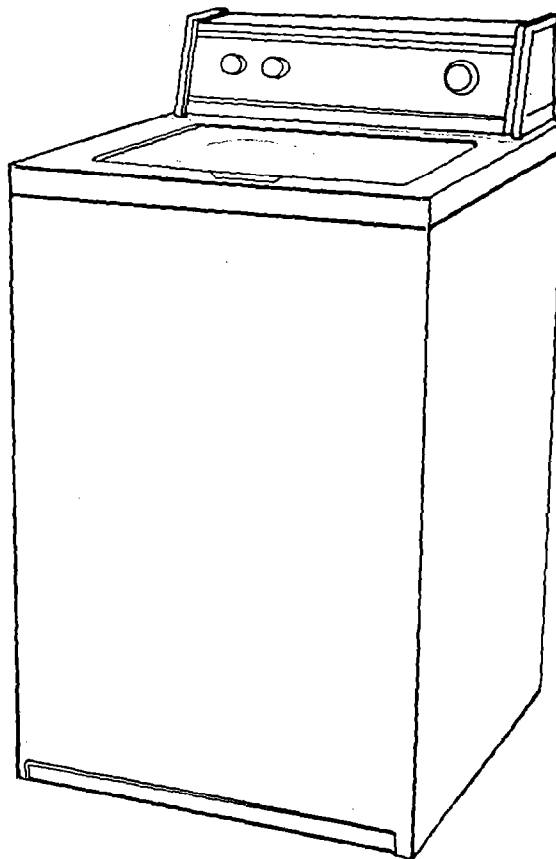

Before you start...

Check location where washer will be installed. Proper installation is your responsibility. Make sure you have everything necessary for correct installation.

Grounded electrical outlet is required. See Electrical requirements.

Standpipe drain system: Needs a two-inch minimum diameter standpipe with minimum carry-away capacity of 17 gallons per minute. Top of standpipe must be at least 34 inches high and no higher than 72 inches from bottom of washer.

Floor drain system requires a siphon break, Part No. 285320.

Untape and open washer lid. Remove packages and hoses from washer.

Hot and cold water faucets: Must be within 4 feet of the back of the washer and provide water pressure 5-100 PSI.

Laundry tub drain system: Needs a 20-gallon laundry tub. Top of tub must be at least 34 inches high and no higher than 72 inches from bottom of washer.

If a longer drain hose is needed, drain hose (Part No. 388423) and hose extension kit (Part No. 285442) are available from authorized parts distributors.

Important: Observe all governing codes and ordinances.

Water heater: Set to deliver 140°F water to washer.

CAUTION

Product Damage

Do Not store or operate washer below 32°F (some water may remain in washer).

See Use & Care Guide for "Winterizing" Information.

Failure to follow above may result in product damage.

Level floor: Maximum slope under entire washer 1 inch.

Support: Entire floor must be sturdy enough to support washer weight 315 pounds.

SEE RECESSED AREA INSTRUCTIONS ON BACK COVER.

Tools needed for installation:

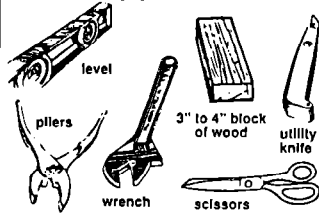

Parts supplied for installation:

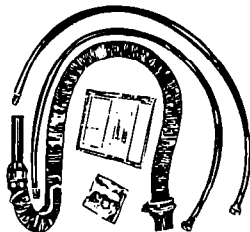

Remove parts from packages. Check that all parts were included.

1 wire form
1 literature package
1 drain hose
1 hose clamp

2 inlet hoses
4 flat water hose washers
2 front leveling legs with nuts

Electrical requirements

WARNING

Electrical Shock Hazard

- Electrical ground is required on this appliance.
- If cold water pipe is interrupted by plastic, non-metallic gaskets or other insulating materials, Do Not use for grounding.
- Do Not ground to a gas pipe.
- Do Not modify the power supply cord plug. If it does not fit the outlet, have a proper outlet installed by a qualified electrician.
- Do Not have a fuse in the neutral or grounding circuit. A fuse in the neutral or grounding circuit could result in an electrical shock.
- Do Not use an extension cord with this appliance.
- Check with a qualified electrician if you are in doubt as to whether the appliance is properly grounded.

Failure to follow these instructions could result in serious injury or death.

If codes permit and a separate grounding wire is used, it is recommended that a qualified electrician determine that the grounding path is adequate.

120-Volt, 60-Hz, AC-only, 15- or 20-ampere fused electrical supply is required. (Time-delay fuse or circuit breaker is recommended.) It is recommended that a separate circuit serving only this appliance be provided.

Recommended grounding method

For your personal safety, this appliance must be grounded. This appliance is equipped with a power supply cord having a 3-prong grounding plug. To minimize possible shock hazard, the cord must be plugged into a mating 3-prong grounding-type wall receptacle, grounded in accordance with National Electrical Code, ANSI/NFPA 70-latest edition and all local codes and ordinances. See Figure 1. If a mating wall receptacle is not available, it is the personal responsibility and obligation of the customer to have a properly grounded 3-prong wall receptacle installed by a qualified electrician.

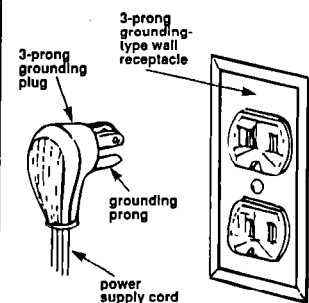
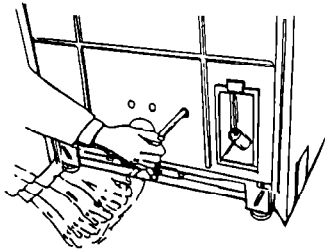

Figure 1

Now start...

With washer in laundry area.



Pull the strap completely out of the washer.

1.

Remove tape that covers shipping strap. Pull to completely remove the shipping strap from the inside of the washer.

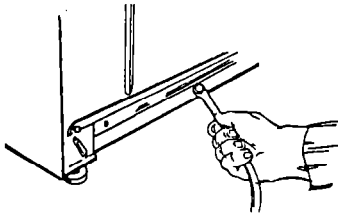

Pull firmly to remove the other end of shipping strap from the back of the washer. The shipping strap plug must be completely removed from the washer for the self-leveling legs to be released.

Save the shipping strap for use in Step 17.

2. Read, then remove label that covers power cord and drain connector. Peel the tape down and off each side of cabinet.

Use new hoses and washers that came with your washer.

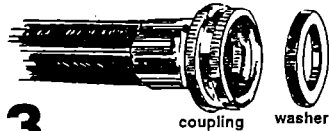

3.

coupling washer

Insert a flat washer into each end of the inlet hoses. Check that washers are firmly seated in couplings.

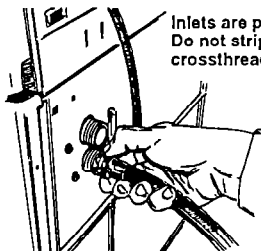

Inlets are plastic. Do not strip or crossthread.

4. Attach hose to bottom inlet valve opening first; then second hose to top inlet. Tighten couplings by hand. Then use pliers to make an additional two-thirds turn.

5. Place hose clamp over washer drain connector. Push coupling end of drain hose onto washer connector. Use pliers to open clamp and slide clamp over drain hose. Check for good fit.

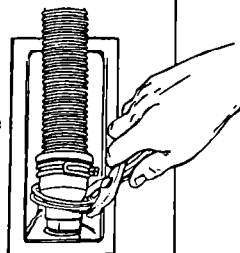

Numbers correspond to steps.

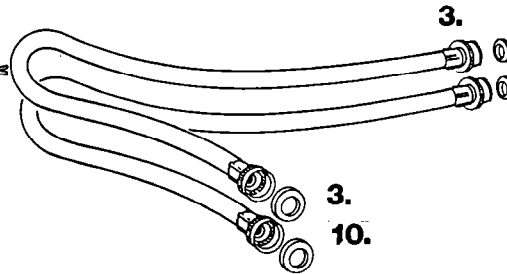

Pull this strap completely out of the washer.

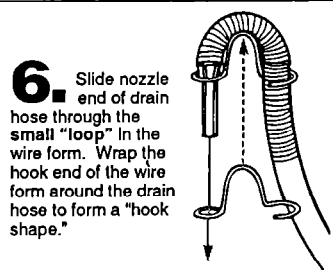
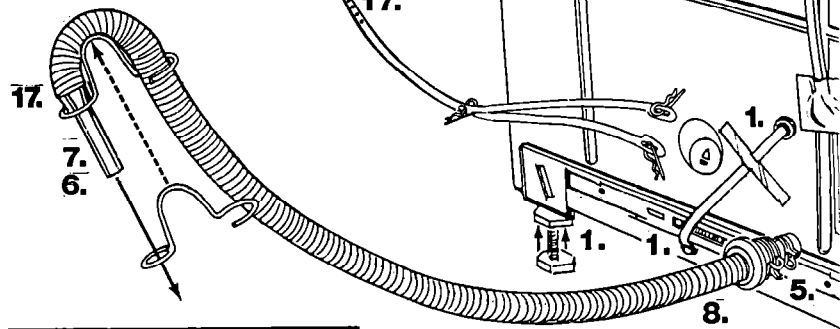

6. Slide nozzle end of drain hose through the small "loop" in the wire form. Wrap the hook end of the wire form around the drain hose to form a "hook shape."

CAUTION

Floor Damage

Slide washer onto cardboard or hardboard before moving across floor.

Failure to do so may cause damage to floor covering.

7. Move washer close to final position. Put "hook" end of drain hose into laundry tub or standpipe. Check for proper length of drain hose.

8. If drain hose is too long — disconnect. Remove clamp and couplings. Estimate length of drain hose needed. Cut flexible end of hose.

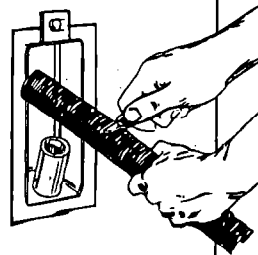

(Do not cut hook-shaped end of drain hose.) Push and twist coupling securely onto drain hose. (You should feel top of hose through coupling.) Slide clamp over coupling and hose. Reinstall drain hose. (See Step 5.)

DO NOT FORCE EXCESS LENGTH OF DRAIN HOSE DOWN THE STANDPIPE. THIS COULD CAUSE SIPHONING.

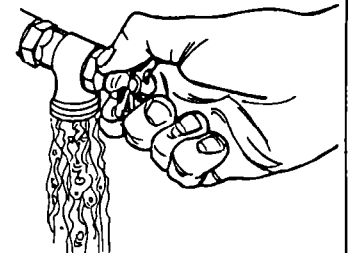

9. Before attaching water inlet hose, run water through both faucets into a bucket. This will get rid of particles in the water lines that might clog hoses.

10. Attach bottom hose (inlet marked "H") to hot water faucet. Attach top hose (inlet marked "C") to cold water faucet. Tighten coupling to faucet by hand; then use pliers to make final two-thirds turn.

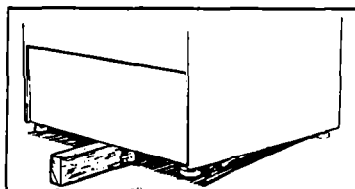
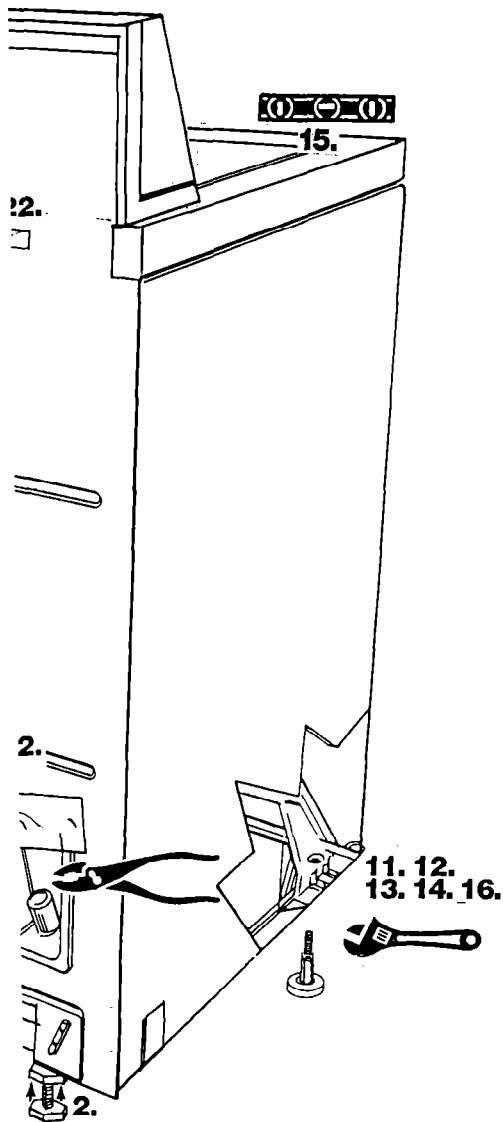

11. Carefully tilt washer backward until front of washer is 3-4 inches off of floor. Insert piece of wood as brace.

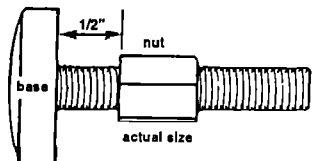

12. Use legs and nuts from parts package. Screw nut down to within 1/2" of base.

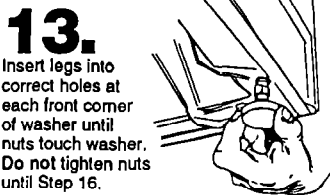

13. Insert legs into correct holes at each front corner of washer until nuts touch washer. Do not tighten nuts until Step 16.

Panel C

14. Tilt washer backward and remove wood brace. Gently lower washer to floor. Move washer to its final location. Remove cardboard or hardboard from under washer.

CAUTION

Floor Damage
Slide washer onto cardboard or hardboard before moving across floor. Failure to do so may cause damage to floor covering.

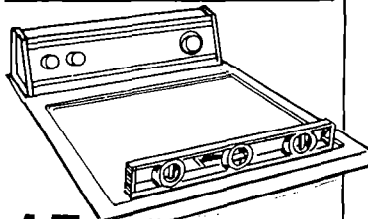

15. Tilt washer forward, raising back legs 1" off of floor to adjust rear self-leveling legs. Gently lower washer to floor. Check levelness of the washer by placing a carpenter's level on top of the washer, first side to side; then front to back.



16. If washer is not level, screw the front legs up or down to adjust. Make final check with level.

When washer is level, use wrench to turn nuts on front legs up tightly against washer base. If nuts are not tight against washer base, the washer may vibrate.

CAUTION

Property Damage
Secure the drain hose to the tub or standpipe with the shipping strap removed from the back of the washer. Failure to properly secure drain hose could result in water damage.

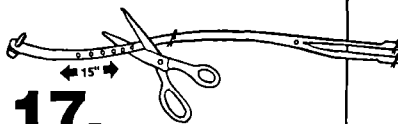

17. Measure and mark a point approximately 15 inches from the plug end of the shipping strap. Cut the shipping strap at this point.

Check that hose is not twisted or kinked and is securely in place.

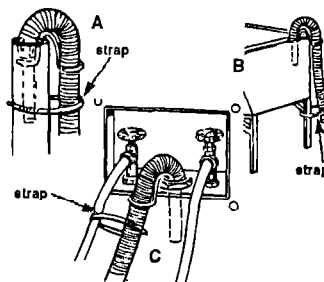

Put "hook" end of drain hose in tub or standpipe. Tightly wrap the shipping strap around the drain hose and tub or standpipe or inlet hose as shown in Figures A-C. Push plug into the nearest hole in the shipping strap.

Hose must be cut exactly to length so "hook" end is held tightly over edge of tub or standpipe.

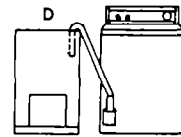

Check that hose is not twisted or kinked and is securely in place.

If drain hose cannot be strapped in place, it must be cut exactly to length so the "hook" end is held tightly over the edge of the tub or standpipe.

Note: If washer is moved to adjust drain hose, the washer must be leveled again. Repeat Steps 15-16. Place cardboard under the washer and carefully move washer to avoid damaging floor covering.

18. CHECK ELECTRICAL REQUIREMENTS. BE SURE YOU HAVE CORRECT ELECTRICAL SUPPLY AND RECOMMENDED GROUNDING METHOD.

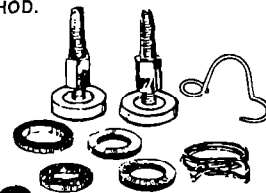

19. Check that all parts are now installed. See parts list, Panel A. If there is an extra part, go back through steps to see which step was skipped.

20. Turn on water faucets and check for leaks. Tighten couplings if there is leaking.

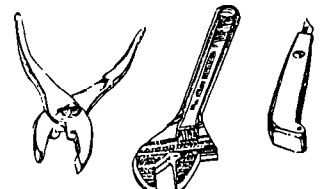
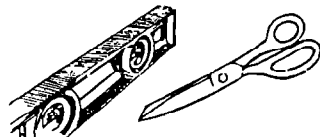

21. Check that you have all of your tools. Check that the shipping strap with 3 cotterpins and plug was removed from the back of the washer and used to secure the drain hose.

22. Untape electrical cord and plug into grounded outlet.

23. Take a few minutes and read the Use and Care Guide to fully understand your new washer. Now start the washer and allow it to complete the regular cycle.

To get the most efficient use from your washer, read your KitchenAid Use and Care Guide. Keep Installation Instructions and Guide close to washer for easy reference.

Recessed area instructions.

This washer may be installed in a recessed area or closet.

The installation spacing is in inches and is minimum allowable.

Additional spacing should be considered for ease of installation and servicing.

If closet door is installed, the minimum air openings in top and bottom are required. Louvered doors with air openings in top and bottom are acceptable.

Companion appliance spacing should be considered.

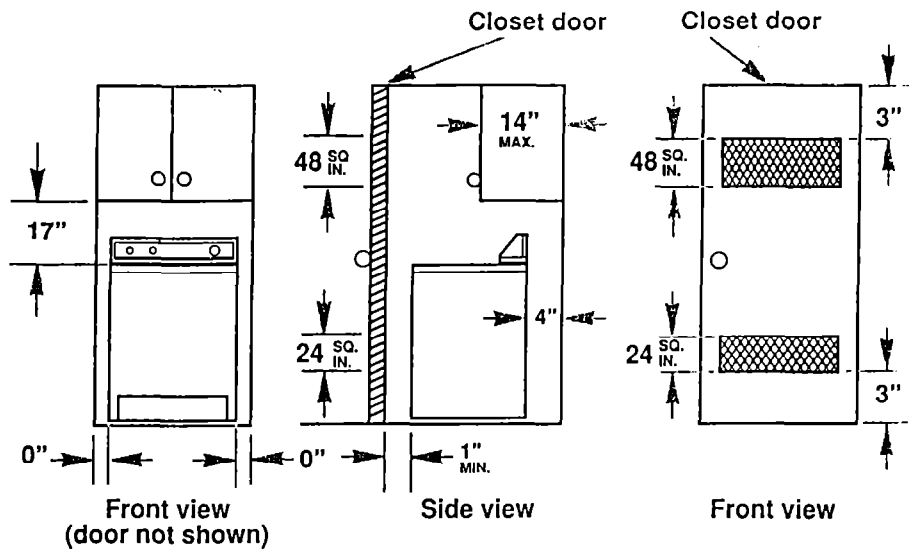

Minimum installation spacing

If you need assistance...

The KitchenAid Consumer Assistance Center will answer any questions about operating or maintaining your washer not covered in the Installation Instructions. The KitchenAid Consumer Assistance Center is open 24 hours a day, 7 days a week. Just dial (800) 422-1230 — the call is free.

When you call, you will need the washer model number and serial number. Both numbers can be found on the serial/rating plate located under the washer lid and on top of the washer.

If you need service...

In the event that your KitchenAid appliance should need service, call the dealer from whom you purchased the appliance or a KitchenAid-authorized service company. A KitchenAid-authorized service company is listed in the Yellow Pages of your telephone directory under "Appliances — Household — Major — Service or Repair". You can also obtain the service company's name and telephone number by dialing, free, within the continental United States, the KitchenAid Consumer Assistance Center telephone number, (800) 422-1230. A special operator

will tell you the name and number of your nearest KitchenAid-authorized service company.

Maintain the quality built into your KitchenAid appliance — call a KitchenAid-authorized service company.

KitchenAid[™]