

KENWOOD

KVWA146SL

**WASHING MACHINE
USER MANUAL**

THE CONTENTS

SECTION 1:BEFORE USING

- Safety warnings
- Recommendations

SECTION 2:INSTALLATION

- Removal of transportation screws
- Adjustment of feet
- Electrical connection
- Water supply connection
- Water drain connection

SECTION 3: GETTING TO KNOW YOUR WASHING MACHINE

SECTION 4:CONTROL PANEL

- Start/Pause button
- Function indicator lights
- Function buttons
- Program knob

SECTION 5:WASHING YOUR LAUNDRY

- Before washing
- Running the machine

SECTION 6:MAINTENANCE AND CLEANING

- Water inlet filters
- Pump filter
- Detergent drawer
- Siphon plug
- The cabinet
- The drum
- Removal of limescale

SECTION 7: PRACTICAL INFORMATION

SECTION 8:AVOIDING MINOR FAULTS

SECTION 9:AUTOMATIC FAILURE DETECTION SYSTEM

SECTION 10:INTERNATIONAL WASHING SIGNS

SECTION 11:TECHNICAL SPECIFICATIONS

SECTION 1:BEFORE USING

SAFETY WARNINGS

- Do not use a multiple socket or extension cord.
- Do not insert a plug with damaged or broken cord into the socket.
- If the cord is damaged it should be replaced by the manufacturer or a qualified service engineer in order to avoid a hazard.
- Never remove the plug from the socket by pulling the cord.
- Do not insert the plug with wet hands.
- Never touch the machine with wet hands or feet.
- Never open the detergent drawer while the device is running.
- Never force open the door of the machine while the machine is running.
- Since the machine can reach high temperatures while running, do not touch the drain hose and water connections when the machine is on.
- In case of any failure, first unplug the device and close the water tap. Do not attempt to repair. Contact a qualified service engineer.
- Do not forget that the packing material of your machine is hazardous for children.
- Do not let your children play with the washing machine.
- Keep your pet away from your machine.
- When using this machine use the guidelines within the manual.
- Your machine is designed for domestic use. Warranty will be invalid if you use it for commercial purposes.
- This product is designed in order to work between 15-35 °C.
- This appliance should not be installed on thick pile carpet.

RECOMMENDATIONS

- If the detergent or softener is in contact with the air for a long time it will dry and stick to your detergent drawer. To avoid this put your detergent and softener into the detergent drawer just before washing.
- It is recommended that you use pre-washing program for only very dirty clothes.
- Please do not exceed the maximum loading capacity of 6 kg.

- If you are not using your machine for a long time, unplug from the mains supply, close the water supply and leave the door open in order to keep the inside of the machine dry and prevent unpleasant odours.
- As a result of the quality control procedures, a certain amount of water may remain in your machine. This is not harmful for your machine.

SECTION 2: INSTALLATION

You must pay attention to the following issues before using your washing machine.

REMOVAL OF TRANSPORTATION SCREWS

- Transportation screws, which are located at the back of the machine, must be removed before running the machine.
- Loosen the screws by rotating counterclockwise by a suitable wrench. (DIAGRAM-1)
- Remove the screws by pulling them. (DIAGRAM-2)
- The plastic parts located in the interior part of your machine will fall down under the device.
- Lift your machine up slightly, pick up the plastic parts (2 persons recommended).
- If all of the plastic parts of screw groups have not fallen down; open the door of your machine, move the drum until all plastic parts fall down. Collect the parts that have fallen to the floor. There are two plastic parts per screw.
- To the holes where the transport screws have been removed, insert the plastic transport screw caps found in the accessories bag. (DIAGRAM-3)
- The transportation screws, that have been removed from the machine should be kept for any other transportation necessities.



DIAGRAM-1

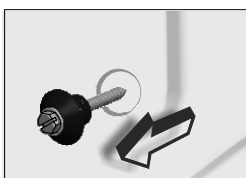

DIAGRAM-2

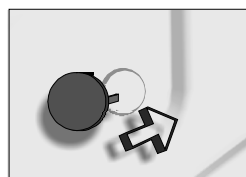
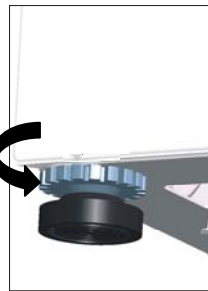

DIAGRAM-3

ADJUSTMENT OF FEET

- Do not install your machine on rugs or similar surfaces.
- For your machine to work silently and without any vibration, it should be installed on a flat, non-slippery and tough ground.

- You can adjust the balance of your machine from its feet.
- First, loosen the plastic adjustment nut by turning clockwise(A).
- Adjust by rotating the feet upwards or downwards.
- After the balance has been reached, tighten the plastic adjustment nut again by rotating it counter clockwise(B).
- Never put cartons, wooden blocks or similar materials under the machine to balance or level the ground.



A

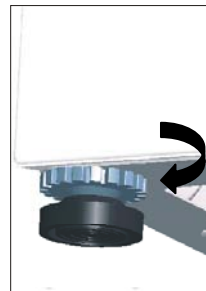

B

ELECTRICAL CONNECTION

- Your washing machine works with 220-240V and 50Hz.
- A special earthed plug has been attached to the cable of your washing machine. This plug must be inserted to a earthed socket. The fuse value should be 10 amp. If you have no such sockets and fuses in your house, contact a qualified electrician.
- **Our company will not be responsible for any damages that may occur as a result of usage without earthing.**

WATER SUPPLY CONNECTION

- This model is designed for cold fill only.
- To prevent leakage from the connection joints, make sure the washer at the end of water inlet hose is fitted.
- Connect the hose provided to the water inlet valve. Tighten the plastic parts of the connections with your hand. Contact a qualified plumber for any assistance needed.

- Water pressure of 1-10 bars from your tap will enable your machine to work more efficiently.(1 bar pressure means water flow of more than 8 liters in 1 minute from a fully opened tap).
- After connections are completed, check for leakage of the connection joints by turning on your tap completely.
- Be sure that water inlet hoses are not folded, broken or crushed.
- Connect the other end of the water inlet hoses to a ¾", thread water tap.

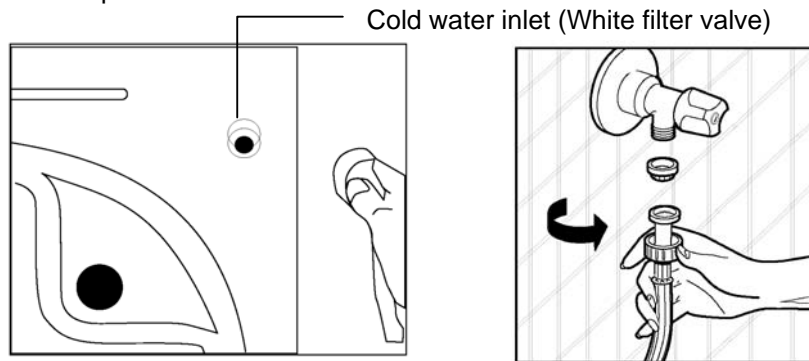

WATER DRAIN CONNECTION

- Be sure that water inlet hoses are not folded, twisted, crushed or elongated by stretching.
- Water drain hose should be mounted at a height of minimum 60 cm, maximum 100 cm from the ground.
- The end of the water drain hose may directly be fitted to the dirty water outlet hole or a special apparatus mounted on the outlet bracket of the wash-stand.
- Never attempt to extend the water drain hose by adding extra parts.

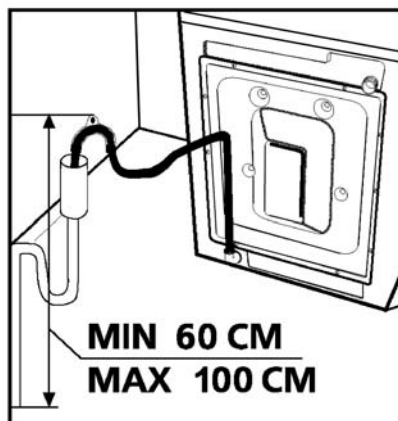

SECTION 3: GETTING TO KNOW YOUR WASHING MACHINE

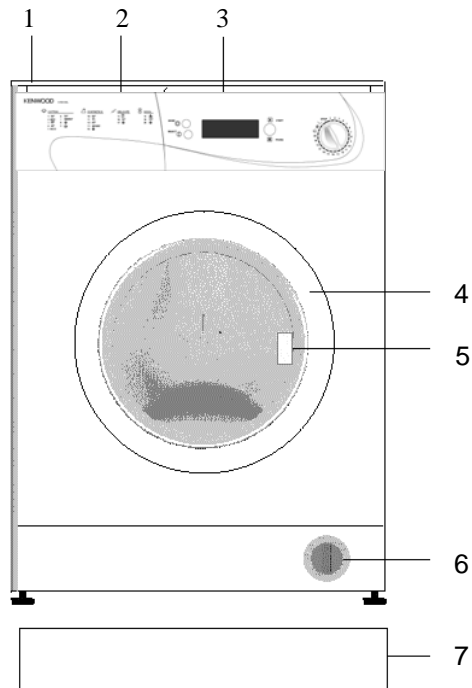

1-Upper tray
2-Detergent drawer
3-Control panel
4-Door

5-Handle
6-Filter cover
7-Kickplate

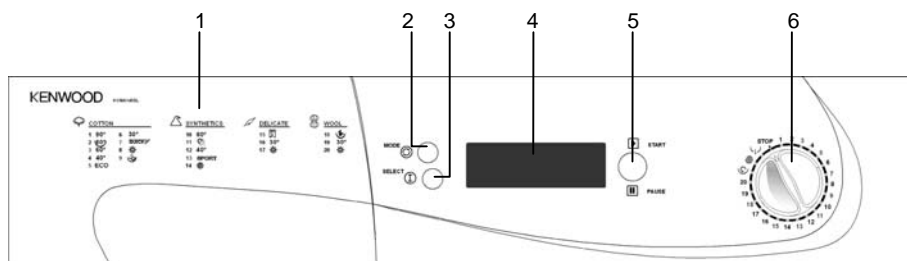

SECTION 4:CONTROL PANEL



1-Detergent drawer
2-Mode button
3-Select button

4-Electronic display
5-Start/pause button
6-Program knob

START PAUSE **START/PAUSE BUTTON**

This key is used for starting a programme selected or pausing by an operating programme. Once a programme selected is started, the symbol  lights up on the electronic instrument. When it is pausing, the symbol  lights up on the electronic instrument.

WARNING

The programme knob must be turned into the position 0(stop) before selecting the programme or changing a programme being continued.

MODE BUTTON

You can select the supplement functions of your washing machine by using the mode key. Each time you press on this key, the symbol of a function will be displayed on the electronic instrument.

SELECT BUTTON

To activate the function use the select key and the function symbol will be show on the electronic display. You can then change the settings.

NOTE:During pause mode and at the end of a cycle the machine must be turned to 0 (stop) before selecting the next programme.

FUNCTION BUTTONS



Rinse hold

This function is recommended to be used when the clothes cannot be taken immediately after the end of the program. This will prevent occurrence of wrinkles. When this button is pressed, the last rinsing water is not drained. For the program to continue from the same point, repress the same button.



Extra rinse

You can have one more rinsing done in addition to the rinses which your machine has made in all washing programs by using this function.



Soak

Using this function will ensure better cleaning by leaving your clothes in water with detergent for a certain period of time before your machine takes in the initial water and starts washing. This function is recommended to be used for very dirty clothes.



Easy ironing

By using this function, you can ensure your clothes to come out less wrinkled after the washing.



Plus water

By using this function, you can enable your machine to take in some more water than the amount in the normal washing operation. This will decrease the friction that occurs between your clothes. This function is recommended to be used for your sensitive clothes or for the ones you desire to be rinsed really well.



Stain remove

You can ensure a more intensive washing with keeping fixed the temperature during the washing by using this function. It is advised that you should use this function in very dirty and stained laundries.

Note: A list of available functions can be found at the back of this instruction book. More than one additional function can be selected at once.



Adjusting wash water temperature

You can adjust the wash water temperature according to the programme that you have selected, using this function.

WARNING

You can not set the wash water temperature into more than the temperature of the programme that you have selected.



Adjusting the spin cycle

Using this function, you can adjust the spin cycle depending on the feature of your machine.

NOTE: Ensure the spin setting is correct for delicate items.

Child lock



While a washing process is carried out in your machine, a child lock is available so that the programme flow can not be affected when the buttons of the machine are pressed. Child lock will be activated after pressing the start/pause key on the control panel for a period of 3 seconds.



When it is activated, " LOCK" signal will appear on the time indicator. To deactivate it, you should press on the same key for a period of 3 seconds. When it is deactivated, " UNLOCK" signal will be displayed on the time indicator. Child lock will deactivate itself at the end of the programme.

WARNING

Function selection and confirmation keys of your machine will be deactivated when child lock is in use.



Adjustment of the programme start time

Using this function, you can adjust after how long the washing process should start. Once you have selected this function, time indicator will be activated.



Time Indicator

PROGRAM KNOB

With the program knob, you can select the program with which you desire to wash your clothes. You can adjust the program selection process by turning the program knob in both directions. You must be careful that the adjustment sign of the program knob is exactly on the program you want to select. When you bring the program knob to STOP(off) position, while your machine is running, your program will remain incomplete.

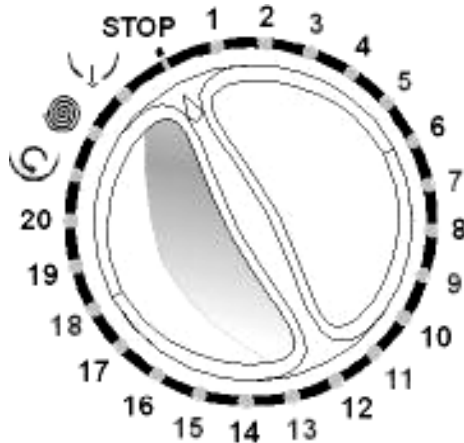

STOP Off

- 1 Cotton 90°
- 2 Cotton 60° (Prewash)
- 3 Cotton 60°
- 4 Cotton 40°
- 5 Eco wash
- 6 Cotton 30°
- 7 Quick wash
- 8 Cotton cold
- 9 Mix wash
- 10 Synthetic 60°
- 11 Baby clothes wash
- 12 Synthetic 40°
- 13 Sport wear
- 14 Synthetic cold
- 15 Curtain wash
- 16 Delicate 30°
- 17 Delicate cold
- 18 Hand wash
- 19 Wool 30°
- 20 Wool cold



SECTION 5: WASHING YOUR LAUNDRY

- Plug in the machine.
- Open the water supply.

First wash cycle

We recommend the first wash cycle should be made without any laundry. Use programme 1 without any detergent.

BEFORE WASHING

- Arrange your clothes according to their types (cotton, synthetic, sensitive, woolen, etc.), washing temperatures and level of dirtiness.
- Never wash your white and coloured clothes together.
- Since your new coloured clothes may shed dye on the first wash, wash them separately.
- Be careful that no metal pieces are found on or in the pockets of your clothes, remove if there is any.
- Zip and button up your clothes.
- Remove the plastic or metal hooks of the curtains and laces or place them inside a washing bag and tie.
- Turn trousers, knitted fabric, t-shirt and sweat shirt inside out.
- Wash your small clothes like socks and handkerchiefs in a washing bag.



Wash up to 90 °C



Wash up to 60 °C



Wash up to 30 °C



Not machine washable

Placement of the clothes into the machine

- Open the door of your machine.
- Place clothes in your machine.
- When you shut the door of your machine, be careful that nothing is jammed between the cover and the rubber seal.
- Shut the door of your machine tightly otherwise your machine will not start the washing process.

Filling detergent in the machine

The quantity of the detergent that you will fill in your machine depends on the following criteria:

- Your detergent consumption will change according to the soil level of your clothes. For your slightly dirty clothes, do not pre-wash and put a small amount of detergent in the compartment no.2 of the detergent drawer.
- For your excessively dirty clothes, select a program with pre-washing, fill ¼ portion of the detergent you will put in compartment 1 in the detergent drawer and the remaining portion in compartment 2.
- In your machine, use the detergents developed especially for automatic washing machines. The quantities that will be used for your clothes are written on the packing of the detergents.
- As the hardness of your water increases, the amount of the detergent to be consumed will also increase.
- As the amount of your clothes increases, the amount of the detergent to be consumed will also increase.
- Fill your softener in the softener compartment in your detergent drawer. Do not exceed the MAX level. Otherwise, the softener will diffuse in the washing water via the siphon.
- The softeners with high density should be diluted with some water before filling in the drawer. That is because the softener with high density obstructs the siphon and prevents the flow of the softener.
- You can use fluid detergents in all programs without pre-washing. For this, mount the fluid detergent level plate in the second compartment of the detergent drawer and arrange the amount of fluid detergent according to the levels on this plate.

OPERATING THE THE WASHING MACHINE

Selection of the programme

- Select the programme suitable for your clothes from Table-1(Page 17).
- Adjust the programme that you have selected by using programme knob.
- The cycle time will be displayed.

NOTE: If you are trying to spin a small load the appliance may take some time to balance the load before spinning commences. You may need to increase the load to successfully complete the spinning cycle. To conserve energy we recommend spinning full loads.

Adjustment of the programme start time

To set the programme start time:



- Select the symbol  located on the electronic display by using Mode key.
- You can set the programme start time as you request with time intervals of one hour, using select key.



- The symbol  will remain illuminated until the programme has been completed.

Programme end times are indicated in the table-2. If the programme start times are not set, washing process will be started in the time depending on the programme feature.

Adjustment of the temperature

To carry out the adjustment of the temperature:



- Move the symbol  located on the electronic display by using Mode key.

- Maximum washing temperature of the programme that you have selected will be displayed on the time indicator.
- You can reduce this temperature up to the washing temperature you request by using the select key. These levels will appear on the time indicator.

- If you want to cancel the temperature, press on the select key until "COLD" signal is displayed on the time indicator. When "COLD" signal appears, the symbol  will be displayed.



- If you have skipped the temperature level that you have requested, you can again adjust this temperature by pushing on the select key repeatedly. If you have selected a different temperature from the maximum temperature, the symbol  on the electronic display will remain illuminated until to the completion of the programme.

Washing temperature levels are indicated in table-2(Page 19). If the adjustment of the temperature is not carried out, washing process will be performed at a maximum temperature depended on the programme feature.

Adjustment of the spin cycle

To carry out the adjustment of spin cycle:



- Select the symbol  located on the electronic display by using Mode key.

- Maximum spin cycle of the programme that you have selected will be displayed on the time indicator.
- You can reduce spin by using select key. These levels will appear on the time indicator.



- If you want to cancel the spin operation, press the select key until "NO SPIN" signal is displayed on the time indicator. When "NO SPIN" signal appears, the symbol  will be displayed.

- If you have skipped the spin cycle level that you have requested, you can again adjust the spin cycle by pushing on the select key repeatedly. If you have selected a different spin cycle from the maximum spin cycle, the symbol  on the electronic display will remain illuminated until the completion of the programme.

Spin cycles are illustrated in the table-2. If the adjustment of the spin cycle is not carried out, spin operation will be performed at a maximum spin cycle depended on the programme feature.

Selection of an additional function

You can use the additional function specified in the table-1, depending on the feature of the programme appropriate to your laundries you have selected. For you to activate the additional functions:



- Press the mode button until the additional function that you want lights up on the display.



- When selected the function symbol will blink and "OFF" will be displayed. Press the select button to activate the function.

- "ON" signal will be displayed on the time indicator.
- If you have selected an additional function, the symbol of the function you have selected will remain on until the completion of the programme.

You can use adjust all of the additional functions described in the table-1 in the washing operation according to the feature of the programme you have selected.

To change additional function

To remove a selected function from the washing operation:



- Select the additional function by using the mode key. "ON" signal will appear on the time indicator.



- Press the select key. "OFF" signal will be displayed on the time indicator.

The additional function you do not want to use will be removed from the washing process.

To change the programme

To remove a programme:



- Press start/ pause key button.
- The symbol  will light up on the display.

- Turn the programme knob into the position 0 (stop).
- Set the programme knob to a programme as you desire. (You can choose the programme you wish from the table-1)





- After you also adjust the other features, you can operate your washing machine by pressing start/ pause key. When your machine is started, the symbol  will turned on the display.

Cancelling the programme

If you want to finish a programme early:



- Press start/ pause button.
- The symbol  will light up on the display.

- Turn the programme knob into the position 0 (stop).
 - Move the programme knob on one that you want from "Spinning" or "Draining" programmes.
- Operate the programme that you have selected by pressing start /pause. When your machine starts to operate, the symbol  will light up on the display.



Completion of the programme



- Your machine stops when the programme that you have selected finishes and “END” signal will appear on the time indicator.
- Turn the programme knob into the position 0 (stop).
- The door lock of your machine will open itself about two minutes after the programme ends. Pull the door handle towards yourself and open the door.
- After removing your laundry leave the door open in order to let the machine dry.

WARNING

If the electricity supply is cut during a washing programme, when the supply is re-connected the machine will resume in the same programme. This will not damage the machine.

Table-2 changes according to the feature of your machine. If your machine is 1400 spin, refer to the table-2 (1400rpm).

PROGRAM	DETERGENT COMPART.	ADDITIONAL FUNCTION BUTTON	MAX DRY LOAD CAPACITY (kg)	TYPE OF LAUNDRY	EXPLANATIONS
			KVWA146SL		
1-COTTON 90°	2		6	Soiled cotton and linen	Underwear, sheet, table cloth, t-shirt, shirt, towel
2-COTTON 60° (PREWASH)	1+2		6	Soiled cotton, coloured and linen	
3-COTTON 60°	2		6	Soiled cotton, coloured and linen	
4-COTTON 40°	2		6	Slightly soiled cotton, coloured and linen	
5-ECO WASH	2		6	Slightly soiled cotton, coloured and linen	
6-COTTON 30°	2		6	Slightly soiled cotton, coloured and linen	
7-QUICK WASH	2		3	Slightly soiled cotton, coloured and linen	
8-COTTON COLD	2		6	Slightly soiled cotton, coloured and linen. Cold wash.	
9-MIX WASH	2		6	Soiled or very stained , cotton, coloured and linen	
10-SYNTHETIC 60°	2		3	Soiled synthetic or synthetic mixture	Nylon socks, blouse
11-BABY CLOTHES WASH	2		3	Baby laundry	All baby laundry
12-SYNTHETIC 40°	2		3	Slightly soiled synthetic or synthetic mixture	Nylon socks, blouse

TABLE-1

PROGRAM	DETERGENT COMPART.	ADDITIONAL FUNCTION BUTTON	MAX DRY LOAD CAPACITY (kg)	TYPE OF LAUNDRY	EXPLANATIONS
			KVWA146SL		
13-SPORT CLOTHES	2		3	Sport clothes	All sport clothes and jeans
14-SYNTHETIC COLD	2		3	Slightly soiled synthetic or synthetic mixture sensitive laundry.Cold water wash.	Nylon socks, blouse
15-CURTAIN WASH	1+2		2	Tulle and curtain as sensitive laundry	Tulle, curtain, diolen, dralon
16-DELICATE 30°	2		2	Slightly soiled cotton, coloured, synthetic or synthetic mixture sensitive laundry	Silk mixture, shirt, blouse, polyester, poliamid, mixture textile
17-DELICATE COLD	2		2	Slightly soiled cold water wash cotton, coloured, synthetic or synthetic mixture sensitive laundry	
18-HAND WASH	2		2	Slightly soiled wash in hand cotton, coloured, synthetic or synthetic mixture laundry	Hand wash to all laundry
19-WOOL 30°	2		2	Soiled, hand and machine to wash wool laundry	All wool laundry
20-WOOL COLD	2		2	Very slightly soiled, cold water, hand and machine to wash wool laundry	
RINSING		When you need an additional rinsing to be done to your clothes after the washing process, you can use this program for all kinds of clothes.			
SPINNING		When you need an additional spinning to be done to your clothes after the washing process, you can use this program for all kinds of clothes.			
DRAINING		This program is used to drain the dirty water inside after the washing process of your machine. If you want the water inside your machine to be drained before the program ends, you can use this program.			

TABLE-1 CONTINUE



PROGRAM	PROGRAM TIME	WASHING TEMPARATURE ADJUSTMENT	SPIN SPEED ADJUSTMENT	DURATION OF THE PROGRAMME CAN CHANGE DEPENDING ON THE AMOUNT OF THE LAUNDRY, TAP WATER AND THE ADDITIONAL FUNCTIONS SELECTED.
1-COTTON 90°	2 hour 38 minute	90-80-70-60-50-45-40-35-30-cold	1400-1200-1000-800-600-400-no spin	
2-COTTON 60° (PREWASH)	2 hour 37 minute	60-50-45-40-35-30-cold	1400-1200-1000-800-600-400-no spin	
3-COTTON 60°	2 hour 35 minute	60-50-45-40-35-30-cold	1400-1200-1000-800-600-400-no spin	
4-COTTON 40°	2 hour 16 minute	40-35-30-cold	1400-1200-1000-800-600-400-no spin	
5-ECO WASH	1 hour 59 minute	40-35-30-cold	1400-1200-1000-800-600-400-no spin	
6-COTTON 30°	2 hour 08 minute	30-cold	1400-1200-1000-800-600-400-no spin	
7-QUICK WASH	30 minute	30-cold	800-600-400-no spin	
8-COTTON COLD	2 hour 3 minute	Cold	1400-1200-1000-800-600-400-no spin	
9-MIX WASH	1 hour 37 minute	40-35-30-cold	800-600-400-no spin	
10-SYNTHETIC 60°	1 hour 38 minute	60-50-45-40-35-30-cold	800-600-400-no spin	
11-BABY CLOTHES WASH	2 hour 12 minute	50-45-40-35-30-cold	800-600-400-no spin	
12-SYNTHETIC 40°	1 hour 27 minute	40-35-30-cold	800-600-400-no spin	
13-SPORT CLOTHES	1 hour 34 minute	40-35-30-cold	800-600-400-no spin	
14-SYNTHETIC COLD	1 hour 13 minute	Cold	800-600-400-no spin	
15-CURTAIN WASH	2 hour 26 minute	40-35-30-cold	600-400-no spin	
16-DELICATE 30°	1 hour 32 minute	30-cold	600-400-no spin	
17-DELICATE COLD	1 hour 26 minute	Cold	600-400-no spin	
18-HAND WASH	1 hour 34 minute	35-30-cold	600-400-no spin	
19-WOOL 30°	1 hour 07 minute	30-cold	600-400-no spin	
20-WOOL COLD	1 hour 04 minute	Cold	600-400-no spin	
RINSING 	33 minute	Cold	800-600-400-no spin	
SPINNING 	10 minute	Cold	800-600-400-no spin	
DRAINING 	3 minute	Cold	-	

TABLE-2(1400 RPM)

OPTION COMPATIBILITIES

	Rinse Hold	Extra Rinse	Easy Ironing	Plus Water	Stain Remove	Soak
Rinse Hold		YES	NO	YES	YES	YES
Extra Rinse			YES	NO	YES	YES
Easy Ironing				YES	YES	YES
Plus Water					YES	YES
Stain Remove						YES
Soak						

SECTION 6: MAINTENANCE AND CLEANING

- Unplug your machine.
- Close the water tap.

WATER INLET FILTERS

On the tap part of your machine's water inlet hose and at the ends of water inlet valves, there are filters to prevent entrance of the dirt and foreign materials in the water to the machine. If the machine is unable to receive sufficient water although your water tap is opened, these filters should be cleaned.

- Remove the water inlet hose.
- Remove the filters found on the water inlet valves by using pliers and wash thoroughly with a brush.
- Clean the filters of the water inlet hoses located on the tap side by removing manually together with the seal.
- After you clean the filters, you can fit them the same way as you have removed.

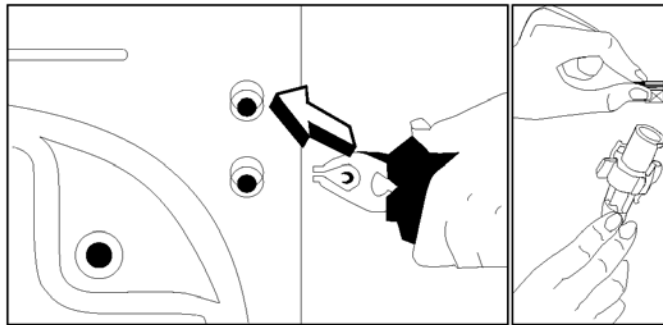

PUMP FILTER

The pump filter system extends the life of your pump, which is used to drain the dirty water. It prevents dirt entering the pump. Cleaning of your pump filter in every 2-3 months is recommended. To clean your pump filter:

- Turn of the machine at the electricity supply.
- Remove the kickplate by pushing with your hand upwards from the lower indents under the cover and pulling towards yourself.
- Before opening the filter cover, place a cup in front of the filter cover to prevent flow of the remaining water in the machine.
- Loosen the filter cover by rotating it counter clockwise and drain the water.
- Remove the foreign materials from the filter.
- Check for the rotation of the pump manually.
- After you have cleaned the pump, fit the filter cover by rotating clockwise.
- Replace the kickplate by clipping it back into position.
- Do not forget that if you do not fit in the filter cover properly, it will leak water.

⚠ WARNING!

Danger of being scalded!

The pump maybe hot, wait for it to cool.

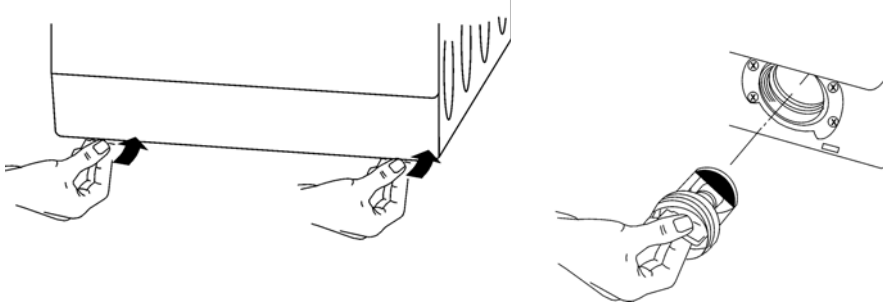

DETERGENT DRAWER

Detergents may form a sediment in your detergent drawer or in housing of the detergent drawer. To clean the sediment, pull out the detergent drawer:

- Pull the detergent drawer to the end.(DIAGRAM-1)
- Lift the front of the drawer, continue to pull while pressing the tab on the softner compartment until the drawer is pull out.(DIAGRAM-2)
- Wash with an old toothbrush and water.
- Remove leftover detergent,avoiding spilling any into the machine.
- Dry the draw and replace.

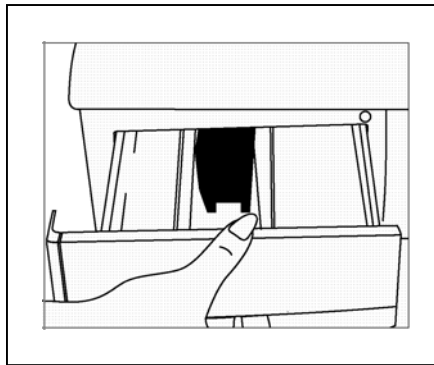

DIAGRAM-1

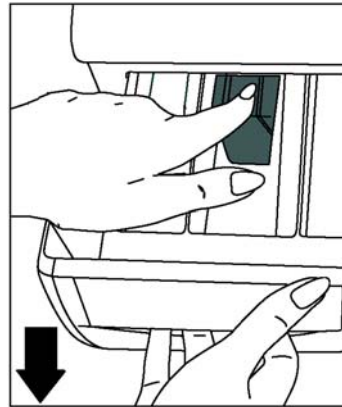
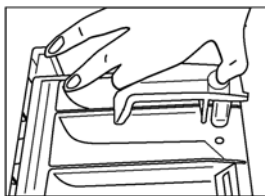

DIAGRAM-2

SIPHON PLUG

Pull out the detergent drawer. Remove the siphon plug and clean the residues of the softener thoroughly. Replace the plug.



THE CABINET

NOTE: Disconnect from the mains supply before cleaning.

Clean the exterior surface of the cabinet of your machine with lukewarm water and a cleaning substance that will not irritate the cabinet. After rinsing with clean water, wipe it with a soft and dry cloth.

⚠ WARNING!

If the machine is installed in a location where the temperature can fall below 0 °C, do the following when it will not be in use:

- Plug in the machine.
- Close the water tap and pull out the water inlet hose or hoses from the tap.
- Place the ends of the water drain and water inlet hoses in a cup on the ground.
- Adjust the program knob to "Draining" program.
- The program ready light will be on.
- Run the program by pressing the start/pause button.
- Unplug your machine when the program is over (program end light is on).

When you complete this process, the remaining water inside the machine will be drained and thus formation of ice in the machine will be prevented. When you operate your machine again, be sure that the temperature is above 0 °C.

THE DRUM

Do not leave metal parts like needles, staples or coins inside your machine. These pieces cause formation of rust stains in the drum. To eliminate these stains of rust, use a cleaning substance without chlorine and follow the warnings of the cleaning substance producer. For cleaning rust stains, never use dish-washing wires or similar rough objects.

REMOVAL OF LIMESCALE FROM YOUR MACHINE

If you arrange the amount of the detergent you use in your machine properly, there will be no need for limescale removal. However, if you desire to apply the removal procedure, use the limescale protectors in the market and pay attention to their warnings.

⚠ WARNING!

The lime eliminating substances contain acids and this may cause colour modifications in your clothes along with an adverse effect on your machine.

SECTION 7:PRACTICAL INFORMATION-STAIN REMOVAL

Alcoholic beverages: Wash with cold water, then wipe with glycerine and water. Rinse with water mixed with vinegar.

Shoe Polish: Scratch the stain without ruining the cloth, rub with detergent and rinse. In case it is not eliminated, it should be rubbed with 1 unit of pure alcohol (96 degrees) mixed in 2 units of water and then washed with lukewarm water.

Tea and coffee: Stretch the stained area on the top of a container and pour water, as hot as the type of your cloth can endure, on it. If the type of your cloth is suitable, wash it with lye(caustic soda).

Chocolate and cocoa: Leave your clothes in cold water and rub with soap or detergent. Wash it in the highest temperature that the type of your cloth can endure. If there is still a stain of oil left, wipe with oxygenated water (in proportion of 3%).

Tomato paste:After scraping the dried pieces, leave in cold water for about 30 minutes and wash by rubbing with detergent.

Egg: Eliminate the dried stain residues, wipe with a sponge or damp cloth. Rub with detergent and wash with diluted lye(caustic soda).

Grease and oil stains: First wipe the residues. Rub the stain with detergent and then wash with lukewarm soapy water.

Mustard: First apply glycerine to the stained area. Rub with detergent and then wash. If the stain still does not disappear, wipe with alcohol (On synthetic and coloured cloth, a mixture of 1 unit alcohol, 2 units water should be used).

Blood stain: Leave your clothes in cold water for 30 minutes. If the stain still does not disappear, lay in mixture of water and ammonia (3 table-spoons of ammonia in 4 liters of water)for 30 minutes.

Cream, ice-cream and milk: Leave your clothes in cold water and rub the stained area with detergent. If the stain has still not disappeared, apply lye on the fabric of your clothes in proper proportion.(Do not use lye on coloured clothes.)

Mould: Mould stains should be cleaned as soon as possible. The stain should be washed with detergent.

Ink: Hold the stained area under cold water and wait until the inky water completely runs off. Then rub with water diluted with lemon juice and detergent, wash after 5 minutes.

Fruit: Stretch the stained area of your clothes on the top of a container and pour cold water on it. Do not pour hot water on the stain. Wipe with cold water and apply glycerine. Wait for 1-2 hours and rinse after wiping with a few drops of white vinegar.

Grass stain: Rub the stained part with detergent. If the type of fabric is suitable for use of lye, wash it with lye. Rub your woolen clothes with alcohol. (For coloured ones, a mixture of 1 unit pure alcohol and 2 units of water).

Oil Paint: The stain should be eliminated before it dries by applying thinner on it. Then it should be rubbed with detergent and washed.

Burnt stain: If your cloth is suitable for use of lye, you can add lye into your washing water. For woolen fabric, a cloth damped in oxygenated water should be covered on the stain and it should be ironed with a dry cloth on it. It should be washed after rinsing well.

SECTION 8: AVOIDING MINOR FAULTS

Use the trouble shooting information on the following pages to avoid minor faults. If a repair is required, follow the steps below:

- Unplug the machine.
- Close the water tap.
- Contact a qualified engineer.

FAILURE	PROBABLE CAUSE	METHODS OF ELIMINATION
Your machine does not operate.	It is unplugged.	Insert the plug into the socket.
	Your fuse is defected.	Change your fuse.
	Power is off.	Check the electric power.
	Start/pause button has not been pressed.	Press the start/pause button.
	The program knob is in O(off) status.	Bring the program knob on the desired status.
	The door is not shut properly.	Shut the door properly. The door will click.
Your machine does not receive water.	Water tap is closed.	Open water tap.
	The water inlet hose may be bent.	Check the water inlet hose.
	The water inlet hose is obstructed.	Clean the filters of water inlet hose. (*)
	The valve inlet filter is obstructed.	Clean the valve inlet filters. (*)
	The door is not shut properly.	Shut the door properly. The door will click.
Your machine is not draining water.	The drain hose is obstructed or bent.	Check the drain hose.
	The pump filter is obstructed.	Clean the pump filter. (*)
Your machine is vibrating.	The feet of your machine are not adjusted.	Adjust the feet. (**)
	Transportation screws are not removed.	Remove transportation screws. (**)

(*)See the section concerning the maintenance and cleaning of your machine.

(**)See the section concerning installations your machine.

FAILURE	PROBABLE CAUSE	METHODS OF ELIMINATION
Your machine is vibrating.	There is a small amount of clothes in the machine.	It does not prevent operation of the machine.
	Excessive amount of clothes are filled in the machine.	Do not exceed the recommended quantity of clothes.
	Your machine touches a rigid object.	Prevent your machine leaning on any other surface.
Excessive foam in the detergent drawer.	Too much detergent has been used.	Press the start/pause button. In order to stop the foam, dilute one table-spoon of softener in half liter of water and pour it in the detergent drawer. Press the start/pause button after 5-10 minutes. Arrange the amount of the detergent properly in the next washing process.
	Wrong detergent has been used.	Use only the detergents produced for full automatic machines.
The washing result is poor.	Your laundry is too soiled for the program you have selected.	Select a suitable program. (see Table-1)
	The amount of detergent used is not sufficient.	Use more detergent.

FAILURE	PROBABLE CAUSE	METHODS OF ELIMINATION
The washing result is not good.	Clothes are exceeding the maximum capacity.	Ensure the wash load is suitable for the cycle.
	Your water may be hard.	Use the amount of detergent according to the declaration of the detergent producer.
	Ensure the wash load is suitable for the cycle.	Spread the clothes inside the machine evenly.
The water is drained from the machine as soon as it is filled.	The end of the water drain hose is in a position too low according to the machine.	Place the water drain hose in an appropriate height.(**)
No water is seen in the drum during washing.	No failure. The water is at the lower part of the drum.	-
There are gray stains on the clothes.	These stains may be caused by oil,cream or ointment .	In the next washing operation, use the maximum detergent amount declared by the detergent producer.

(**) See the section concerning instalations your machine.

FAILURE	PROBABLE CAUSE	METHODS OF ELIMINATION
The spinning process is not done or starts with delay .	No failure. An unbalanced load can cause this.	The unbalanced load control system will try to distribute your clothes evenly. After your clothes are distributed the spinning process will begin. Ensure the wash load is suitable for the spin cycle.

SECTION 9: AUTOMATIC FAILURE DETECTION SYSTEM

Your machine is equipped with systems which will both take the necessary precautions and warn you in case of any failure by controlling itself constantly during the washing processes.





FAILURE CODE	PROBABLE FAILURE	THE PROCESS TO BE DONE
E-1	The door is not shut properly.	Shut the door properly so that you hear the click. If the problem persists, turn off the machine unplug and contact a qualified service engineer.





FAILURE CODE	PROBABLE FAILURE	THE PROCESS TO BE DONE
E-2	The water level in your machine is below heater. The pressure of your water supply may be low or locking.	Check the water supply to the machine. If the problem persists turn off the machine,unplug it and contact a qualified service engineer.
E-3	The pump has failed or the pump filter is obstructed.	Clean the pump filter. (*)





(*) See the section regarding the maintenance and cleaning of your machine.



FAILURE CODE	PROBABLE FAILURE	THE PROCESS TO BE DONE
E-5	The heater of your machine or the heat sensor has failed.	Turn off the machine,unplug it and contact a qualified service engineer.
E-6	The motor has failed.	Turn off the machine,unplug it and contact a qualified service engineer.
E-7	Configuration error.	Turn off the machine,unplug it and contact a qualified service engineer.
E-8	The motor has failed.	Turn off the machine,unplug it and contact a qualified service engineer.
E-9	The supply voltage is too high or too low.	If the supply voltage is lower than 150V or higher than 260V, your machine will automatically stop. When the network voltage is recovered, your machine will continue its operation.

SECTION 10: INTERNATIONAL WASHING SIGNS

			
Washing temperature.	Do not wash (hand wash)	Lukewarm iron.	Medium hot iron.

			
Hot iron.	Do not iron.	Do not tumble dry.	Hang to dry.

			
Drip dry.	Dry flat.	Do not bleach.	Handy to bleach.

		
<p>All of these are dry cleaning symbols. The letters are to instruct the cleaner what type of solvent to be used. Garments bearing these symbols should not be washed in your machine unless the label says otherwise.</p>		

SECTION 11: TECHNICAL SPECIFICATIONS

	KVWA146SL
Rated voltage(V)	230
Rated power(W)	2200
Weight(kg)	65
Maximum dry laundry capacity (kg)	6
Recommended loading (kg)	5,5
Height (cm)	85
Width (cm)	59,6
Depth (cm)	54
Maximum spin cycle (rpm)	1400



This symbol on the product or in the instructions means that your electrical and electronic equipment should be disposed at the end of its life separately from your household waste. There are separate collection systems for recycling in the EU.

For more information, please contact the local authority or your retailer where you purchased the product.

DSG Retail Limited is responsible for after care sales service and any claims in respect of this licensed product. If you have a query about the product please contact our Currys support line on 08701 565 550.



Visit Partmaster.co.uk today for the easiest way to buy electrical spares and accessories.

With over 1 million spares and accessories in stock we can deliver direct to your door the very next day.

Visit www.partmaster.co.uk

or call

0870 6001 338

(UK customers only)

Calls charged at National Rate.

52007623