

HWM60-111P

Twin-tub Washing Machine with Pump



- Please read this manual carefully before using.
- Retain it for future reference
- Please check if the power receptacle has good earthing condition before using to guarantee your safety.
- The manufacturer will not bear the responsibility for those risks occurred from not obeying this manual.



Contents	
Before using	
Names of the parts.....the 2 nd cover	
Safety precautions	1
Installation and adjustment	3
Introduction of the major functions	5
Using process	
Preparation before washing	6
The musts in washing	7
Usage of the detergent	8
Washing sequence	9
Disposal after washing	13
Trouble-shooting*	
Answers to question.....	15
Packing list	17
Specification.....the back cover	

Names of the parts

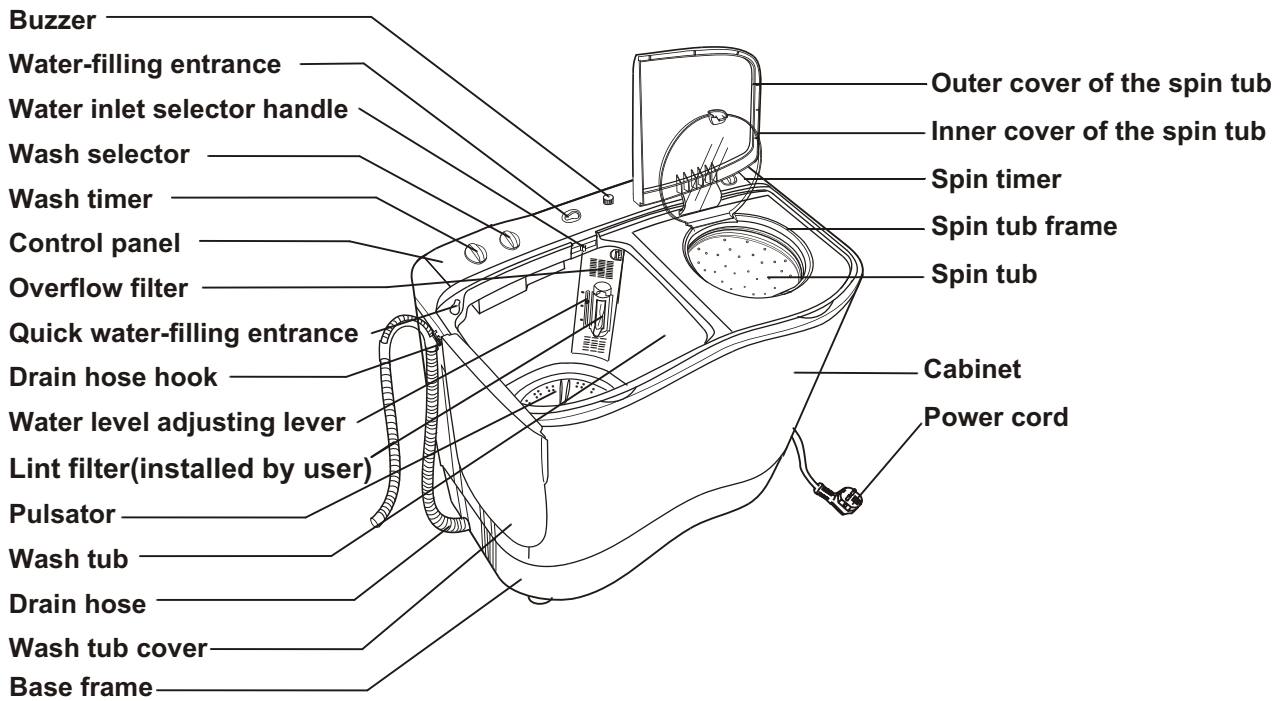

Before Using

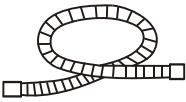

Accessories

	Water-filling jointer (one piece)
	Water inlet hose (one piece)
	Lint filter (one piece)
	Gland (one piece)

Meaning and description of the symbols

Warning sign 	Contents marked with that symbol are related to the safety of the product and the personal safety of the users. Please operate in strict conformity to the contents, otherwise it may cause damage of the machine or injure the personal safety of the user.
Forbidding sign 	Contents marked with that symbol are actions forbidden to perform. Performing of those actions may result in damage of the machine or injure the personal safety of the user.

Safety precautions

Before Using

Please insert the power cord into special receptacle with rated voltage. Be sure to use single-phase three pins receptacle. The earthing terminal of the receptacle must be earthed reliably. If possible, please adopt electric leakage protector.

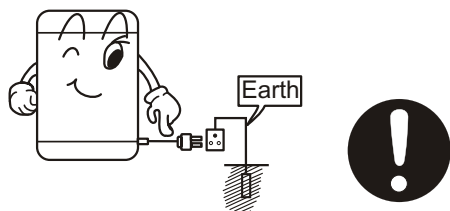

The washing machine should be positioned so that the plug is accessible. Be sure to pull the plug off when there's power failure, or the machine is being moved, cleaned or when it is idle.

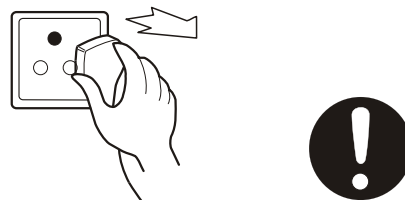

If the supply cord is damaged, it must be replaced by the manufacturer, its service agent or similarly qualified persons in order to avoid a hazard. Keep the pin of the Power plug clean.



The carpet must not obstruct the ventilation openings in the base of the washing machine.

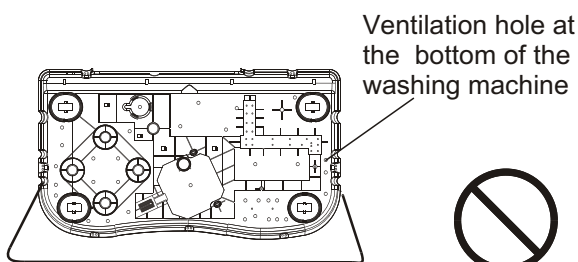

Do not use water hotter than 50°C .

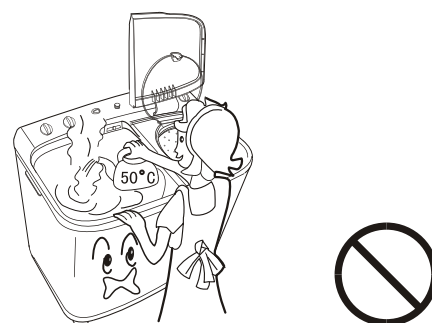

Do not put the machine at damp place like the bathroom . Never wash it with water. Do not place wet laundries on the control panel.

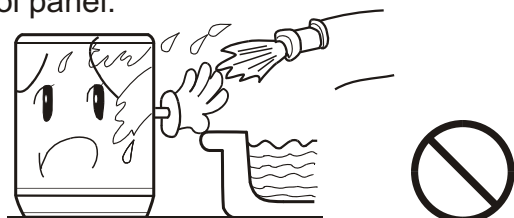

Do not wash water-proof laundries such as the raincoat, bicycle shelter etc. To avoid abnormal vibration during spinning.



Do not share one receptacle with other electric appliances. Do not use it in case that the power plug is damaged or the inserting into the receptacle is loose.



Safety precautions

Before Using

Do not stretch hands into the working machine. It is dangerous even if the rotation is slow. Take special care of the children.

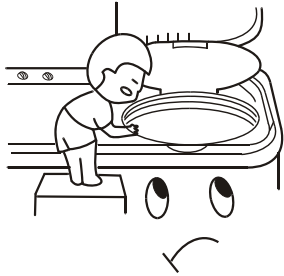

Do not decompose, repair or alter the machine by yourself.

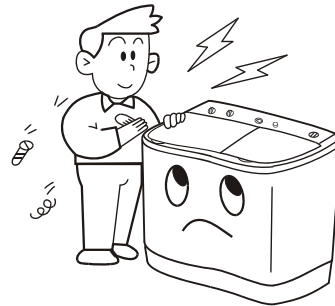

Do not put any hot or heavy items (such as the kettle with hot water) on the washing machine.



Do not wash laundries with volatile materials (such as thinner, petrol etc.).

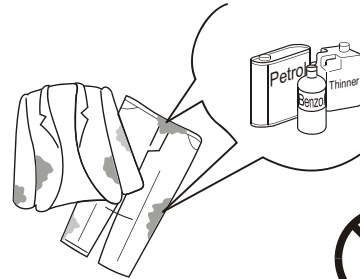

Handicapped or children without care shall not use the machine.

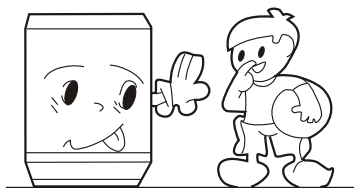

Keep the machine away from direct sunlight and heat source like the heater.

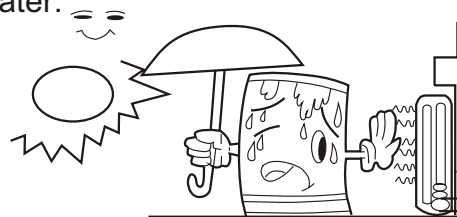

To protect your laundries and washing machine, please take out all of the coins, buttons, sand, hairpin and other foreign materials before washing.



- Please check if the water faucet is open, and if the connection of the water inlet pipe is proper.
- It is suggested to use foamless washing powder.

Installation and adjustment *Before Using*

Please install and adjust the machine according to the requirement of the manual. It is very important to your security and correct operating the machine.

The drainage shall be smooth with the drain hose.

1. The height of the drain hose shall be less than 1.2m, or the drainage will not be smooth enough and cause incomplete drainage.

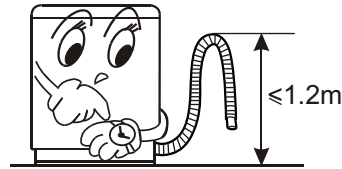

2. Do not step on or press the drain hose.

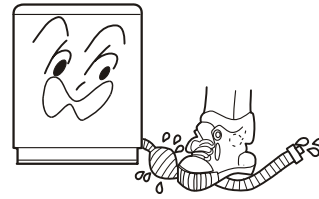

Install the lint filter

After opening the package, please take out the lint filter from the document bag, install it to the overflow filter of the cabinet. See to the figure.

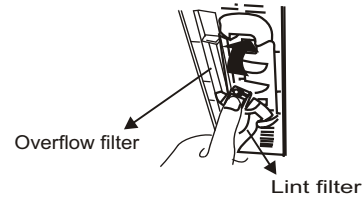

Install the water inlet hose; Select the water level

Insert the water inlet hose into the water-filling entrance on the control panel, then push the water-filling jointer into the entrance on the control panel. (To dismantle the water inlet pipe, just push the control handle as indicated in the figure and pull it out)

Select water level according to the quantity of the laundries.

- Set the water level adjusting lever to needed line.

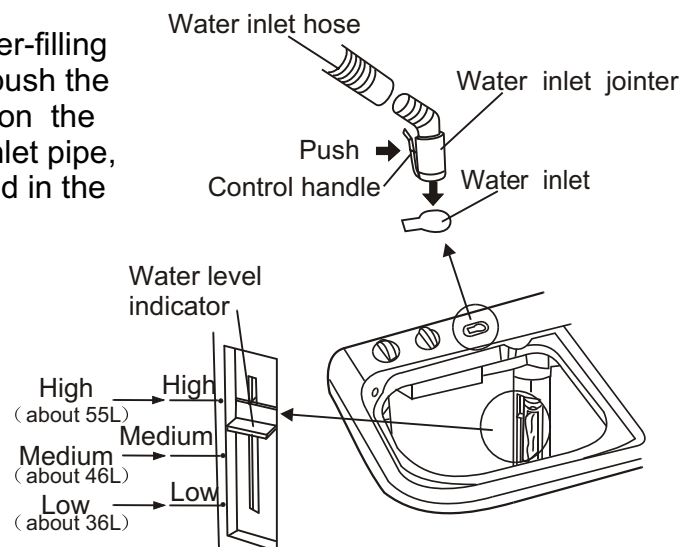

How to change the direction of the drain hoses

- Figure 1 indicates the ex factory installation position of the drain hose.

Figure 1

Extend the drain hose from the side of spin tub.

Take off the drain hose from the hanging hole of the cabinet. Pull the drain hose fixing hook outwards gently to take out the drain hose from the two fixing hooks. (As per Figure 2)

Rotate the drain hose fixing hook for 90° to take it out from the installation hole (As per Figure 3).?

Install the two drain hose fixing hooks taken out into the installation hole at the other side of the base frame (to aim at the installation hole accurately you can lean the washing machine forward slightly). Then rotate for 90° (As per Figure 4).

Pull the fixing hook outwards slightly. Inlay the drain hose into the fixing hooks reliably along the groove at spin tub side, and make it extend towards spin tub side.

Then hang the drain hose into the hanging hole at the spin tub side. (As per Figure

Extend the drain hose from the rear side

Take out the drain hose from the fixing hook. Extend it from the rear side (When the drain hose is extended from the rear side, it can be hung on the point for drain hose at the two sides of the cabinet.) (See to Figure 6).

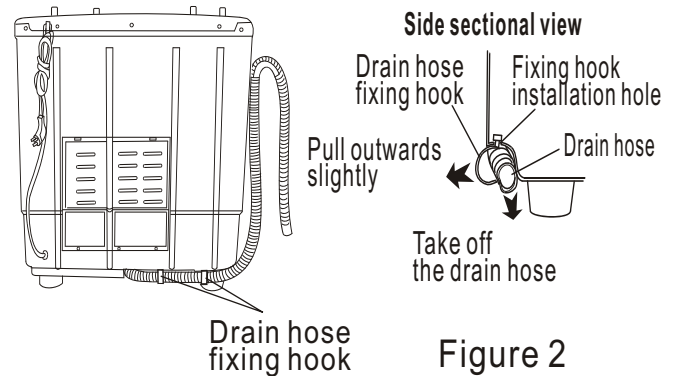

Figure 2

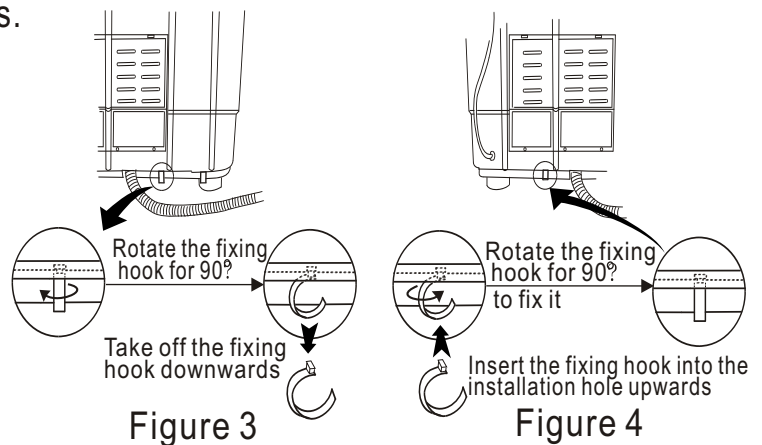

Figure 3

Figure 4

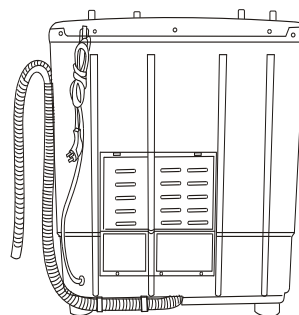

Figure 5

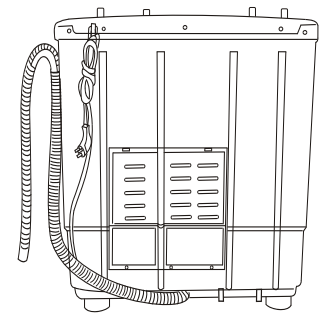

Figure 6

Introduction of the major functions *Before Using*

The machine has good comprehensive performance, and nice appearance.

It adopts streamline appearance and full plastic shell, which will never get rust.

For the design on safety and reliability, it adopts the wash shelf, spin shelf and water reception groove design, and reduces the unfavorable influence on the electrical component by the vapor. Therefore it guarantees more safe and reliable washing.

By the technology of comprehensive energy-saving, the machine can work under wide range of voltage, regardless of the voltage fluctuation.

It adopts complete enclosed base frame and low-noise motor, and thus reduces the working noise significantly. We can guarantee that the purchase of this machine will bring you a clean world without disturbing your quiet life.

Foam-removing spinning during high-efficiency rinsing

Use the foam-removing spinning to remove the extra detergent liquid. It can both shorten the washing time and save the water consumption.

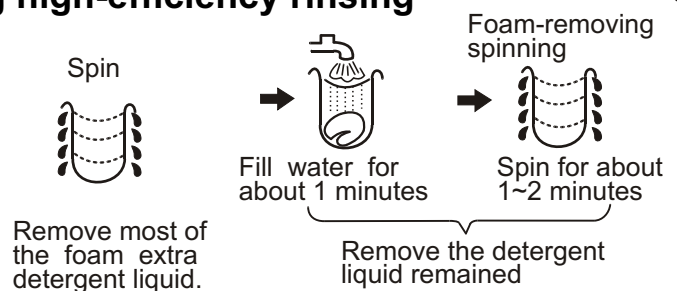

The effect is best when the laundries quantity is below 80% of the rated value.

Quick water-filling entrance

If you do not need spraying spin, you can fill water into the wash tub directly through this entrance. It can reduce the humidity inside the control panel significantly and prolong the operating life of the components.

Quick water-filling entrance

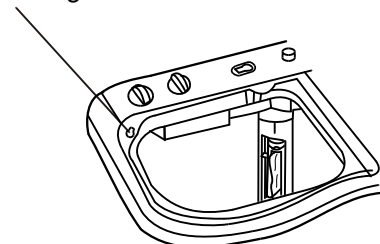

Preparation before washing

Using process



Preparation before washing

1. Connect the water inlet hose.
2. Confirm that the washing machine is earthed reliably. Then insert the power plug into the receptacle. Do not connect the earth terminal to the gas pipe and tap water pipe.
3. Put the drain hose up to suitable position.

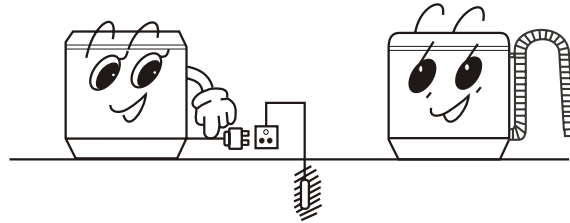

4. Slanting or uneven ground may result in unstable working or abnormal noise. Please make the machine stand horizontally.

Pay attention to followings before washing the laundries

Check if the laundries has special requirement on washing

Clear the pocket. Take out the coins, sand, hairpins etc.

Tie the long strips; fasten the buttons; close zippers.

The quantity of the laundries shall not be too large. Stretch and loosen the laundries before putting them in the tub.

When the pulsator is running, the buttons of the laundries may cause noise. For the sake of discretion, please put the laundries with buttons into other laundries.

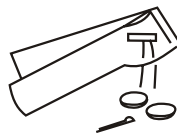

- a. Check if the laundries are applicable for washing with machine.
- b. Divide the laundries that are not colorfast from other laundries.
- c. Put those laundries difficult to absorb water into water with hand.
- d. For those laundries with heavy soil, please first remove the dirt like mud or dust. For the parts with heavy soil, please apply detergent on them in advance, which can make it easier to remove the soil.
- e. For those laundries that may get lint ball and those with long fur, turn it over before putting in.
- f. Do not put those laundries polluted by chemicals into the washing machine directly.

The musts in washing

Using process



- The capacity of washing and spinning of the machine refer to the largest weight of the standard laundries under dry condition that can be washed or spinned in one time. Laundries quantity in one washing cycle shall be lower than the rated capacity.
- The thickness, size, type of the cloth will influence the actual washing capacity. It is suitable to put in reasonable amount of laundries and the laundries can be turned round in washing for one time washing.
- Do not select "Maximum" water level for laundries less than 3.2kg, so as to avoid splashing of water.

Reference weight of the laundries

- Working suit (up,down) (cotton, about 1120g)
- Jeans (about 800g)
- Blending coat about 800g
- Jacket (cotton, about 800g)
- Single bed sheet (cotton, about 600g)
- Socking (blending, about 50g)
- Underpants (cotton, about 70g)
- Undershirt (cotton, about 180g)
- Shirt (cotton, about 300g)
- Pajamas (about 200g)
- Blanket (cotton, about 900g)

Usage of the detergent *Using process*

How to use the whitener

- Fill water to decided level. Dilute the whitener with container. Pour it slowly into the washing tub.
- Avoid using whitener on laundries with color or pattern as they are prone to lose color.
- The whitener shall not touch the laundries directly.
- Refer to the user's manual for the usage and quantity of the whitener.
- For powder whitener, please dissolve it before using.

How to use the washing powder

- | | |
|---|--|
| <ul style="list-style-type: none"> ● Direct dissolved in the machine: <ol style="list-style-type: none"> 1.Fill small quantity of water. 2.Add the powder . Run for 30 seconds to dissolve it completely. 3.Put it in the laundries. Select suitable water level. ● The instant dissolving of the washing powder: <ol style="list-style-type: none"> 1.Prepare warm water of 30°C and a container. 2.Add the powder while stirring to fully dissolve it. | <ul style="list-style-type: none"> ● The powder is more prone to pollute the laundries than the detergent. Therefore please use it with proper quantity. ● It is suggested not to use high sudsing detergent. ● Dosage of different washing powder is different. Please refer to the instruction of the washing powder for the detail dosage. |
|---|--|

Selection of the quantity of the washing powder list 1

Water level (Water quantity)	Standard dosage	
	Concentrated washing powder	Common washing powder
Maximum (about55L)	About 46g	About 55g
Medium (about46L)	About 38g	About 46g
Minimum (about36L)	About 30g	About 36g

Selection of the current , water level and washing time list 2

Current	Water level (Water quantity)	Laundries	Washing time (minutes)
Strong	Medium (about46L) ~ Maximum (about55L)	Knitwear	About3~6
		Cotton,blending,linen	About8~10
		Very dirty and thick	About10~13
		Bed sheet	About7~13
Standard	Minimum (about36L) ~ Medium (about46L)	Silk(thin laundries)	About2~4
		Chemical fiber	About3~6
		Cotton,blending,linen	About8~10

Washing sequence

Using process

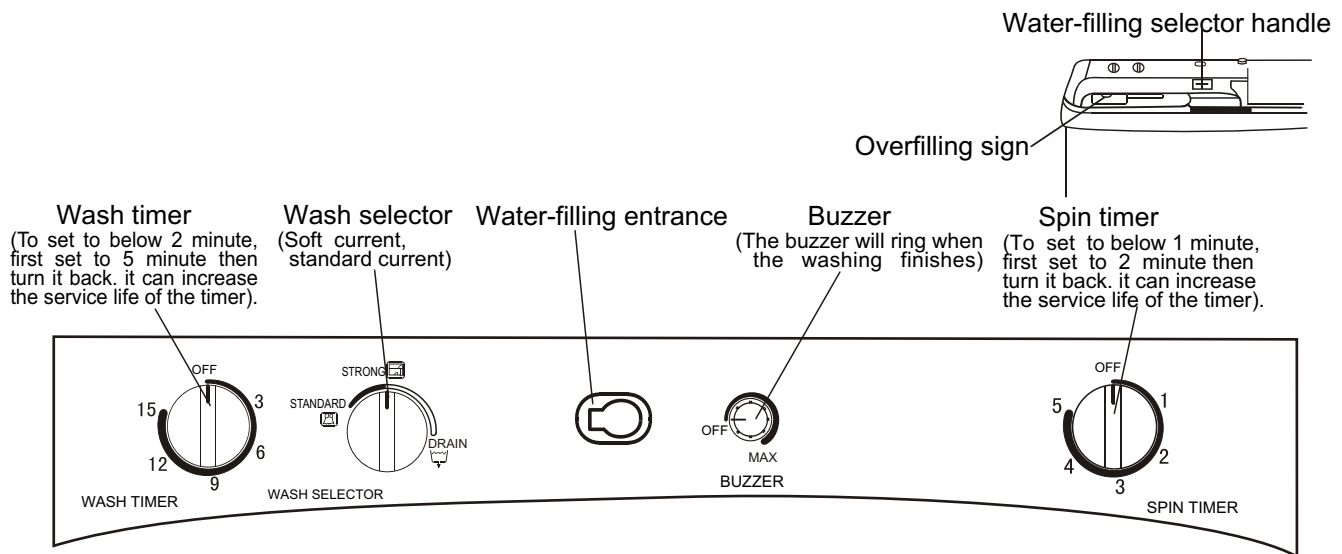

Wash

1. Water-filling selector

(1) Set the water-filling selector at the "WASH" side.
 (Figure 1)

(2) Set the water level adjusting lever to needed line.

2. Fill the water and add the dissolved washing powder to make the water level reach the preset position. (Figure 2)

Run washing program for some time to stir and dissolve the powder completely.



3. Put in the laundries. If the water quantity is insufficient, please add water.



4. Select the current.

Select the strength of the current according to the laundries. (Figure 3)



5. Select the washing time

Select the washing time according to the laundries. (Figure 4)



6. After washing, the buzzer will ring. Set the "WASH SELECTOR" at "DRAIN". (Figure 5).



Figure 1

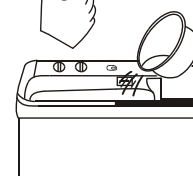

Figure 2

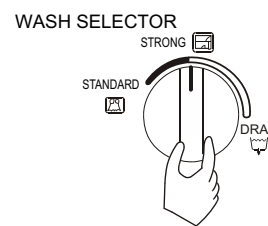

Figure 3

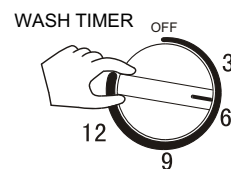

Figure 4

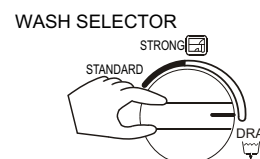

Figure 5

Midway spinning

1. Put the laundries into the spin tub evenly and smoothly.

2. Spin:

(1) Put the gland in properly.

- Please put in the gland properly even if the laundries quantity is small.

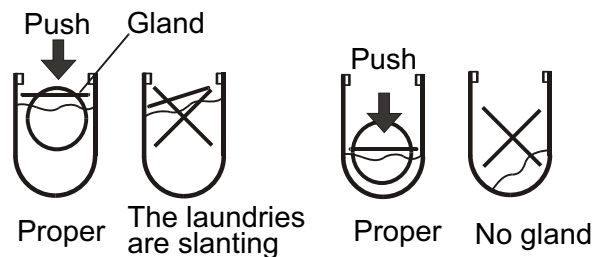

(2) Close the inner and outer cover of the spin tub.

(3) Spin for 1-2 minutes.

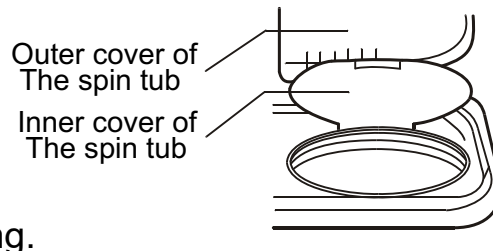

3. Run the foam-removing spinning.

(1) Open the outer cover of the spin tub.

(2) Set the water-filling selector control rod at the "SPIN" side. Fill water for about 1 minute.

- If the water quantity filled is too large, the water may flow out from the wash tub side. Please twist the water tap to limit the water filling.

(3) Close the outer cover of the spin tub. Spin for 1-2 minutes.

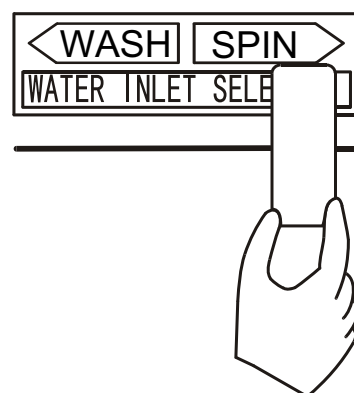

Rinsing

Rinse with water-filing

1. Put the laundries into the wash tub. Select suitable current according to the laundries.



2. Adjust the water level
Set the water level with water level adjusting lever according to the laundries quantity. Then fill suitable water continuously.

3. Rinse
Adjust the wash timer to 5-7 minutes to do rinsing.

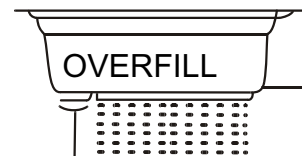

If you find water flowing out here, please twist the water tap to limit the water filling.



Rinse with stored water (Repeat the midway spinning and rinsing with stored water for 2-3 times)

1. Put the laundries into the wash tub. Select suitable current according to the laundries.



2. Fill water to preset water level.
 3. Rinse
Adjust the wash timer to 2-3 minutes to do rinsing.
- When the laundries quantity is below 3.2kg, please use " STANDARD " current. If you use "STRONG" current, it may splash.

Spinning

1. Put the laundries into the spin tub evenly and smoothly.
2. Press the gland in the tub properly. Close the inner and outer cover of the spin tub.
3. Spin
Select suitable spin time according to the laundries, and do spinning.

Selection of the spin time list 3

Laundries	Spin time (minutes)
Bed sheet or blanket	About 4~5
Underwear (knitwear)	About 2~4
Swear (chemical fiber)	About 1~2
Blending thin laundries	Within 1 minute

During spinning, if there's abnormal sound, it is generally owing to slanting placement of the laundries. Please stop the machine and re-order the laundries.

- In spinning, it will pause the work if you open the outer cover of the spin tub. Close it to resume the spinning.



To do spinning and draining or rinsing with water-filling together, please first do spinning for around 1 minute, then do draining or rinsing with water-filling. Otherwise the spinning will stop owing to too much water stored in the spin tub.

Disposal after washing

Using process

- After using, please clean the lint and foreign materials of the lint filter and overflow filter in time. Otherwise it may influence your using the machine.
- Please first pull off the power plug from the receptacle before cleaning.

Cleaning the lint filter

- The lint filter must be used during washing.
- It must be cleaned in time after each using.

1. Take off the lint filter

Put hand at the indicated position. Push down to take it off. (See to Figure 1)

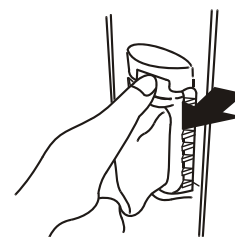

Figure 1

2. Clean the lint

Put it in water and clean while it is still wet. (See to Figure 2)

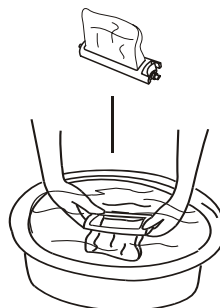

Figure 2

3. Install the lint filter

After cleaning, insert the bottom of the lint filter (marked with "DOWN SIDE") into the overflow filter , then push the upper part of the filter in (marked with " UP SIDE "). (See to Figure 3)



Figure 3

Cleaning the overflow filter

- Too much lint on the overflow filter will influence the normal usage of the machine. Please clean it every two months.

1. Take off the overflow filter.

As indicated in the figure, nip the elastic fixing claw and pull it to the direction of the arrow to take it off.

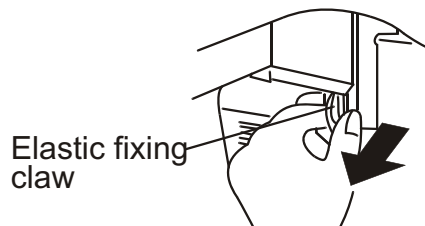

Cleaning the overflow filter

2. Take off the corrugation pipe.
Dismantle the upper part of the corrugation pipe inside the overflow filter (as indicated in Figure 1).

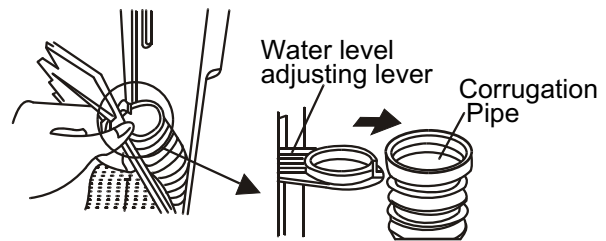

Figure 1

3. Cleaning the overflow filter
Clean the lint around the filter and flush with tap water.

4. Install the overflow filter.
 - (1). Install the corrugation pipe.
 - (2). Insert the mounting plate at the bottom of the filter into original position.
 - (3). Hang up the hook at the left upper side.
 - (4). Push the upper part in as indicated in Figure 2.

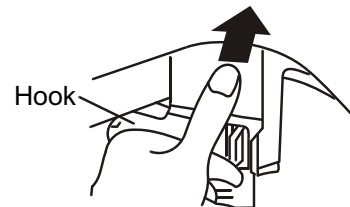

Figure 2

Disposal of the complete unit

- Wipe the complete unit with soft cloth twisted dry.
- Wipe with neutral detergent if too dirty
- Do not wash it directly by water



- After washing, dismantle the water inlet hose.
- Do not store water in the tub for long period. Discharge the water immediately after each using.
- Pull off the power plug and hang up the power cord.
- Hang up the drain hose.
- Wipe off the water drops on the surface and inside the tub with clean soft cloth. Open the cover of the wash tub and the inner/outer cover of the spin tub for some time (about one hour), then close them.

Trouble-shooting Answers to question

If the laundries fall to the outer side of the spin tub

If the laundries fall to the outer side of the spin tub, please take them out immediately.

1. Dismantle

As indicated in the figure, push the point marked with "※" to pull the spin tub frame to oblique upwards to dismantle it.

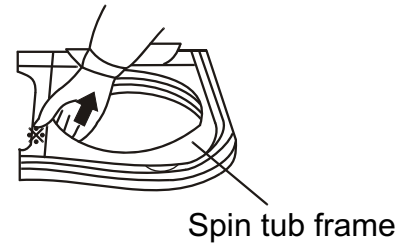

2. Install

After install the back edge of the spin tub frame to proper position, push the four points marked with "※" by force to reset it.

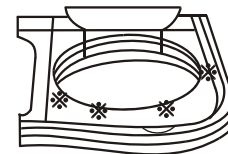

Please check carefully. The laundries may fall to the lower part of the outer side of the spin tub (as indicated in the figure).

- If the laundries fall to the outer side of the spin tub, during spinning the draining will get blocked and the rotation speed of the spin tub is reduced.)

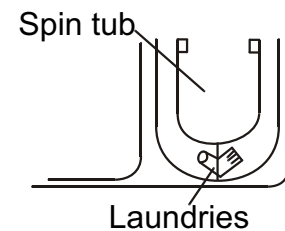

When the remained water is frozen

Prevent the freezing (be sure to discharge the water completely after using)

- After complete draining, set the "WASH SELECTOR" at "STRONG" or "STANDARD". If it is set at "DRAIN", it will be rather difficult for the frozen water to melt.

When the water is frozen

- Pour hot water below 50°C into the wash tub to soak it completely. Then turn the pulsator with hands gently. Please confirm the drainage can work normally before next using.

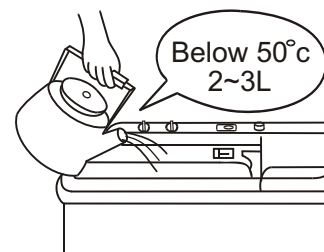

Trouble-shooting Answers to question

(If there's breakdown, please pull off the power plug before checking) The following phenomena are not breakdowns sometimes. Please confirm again before sending it to repair. If there are real breakdowns, please come to the special maintenance department or after-sale service department of our company. Do not repair it by yourself.

Phenomena	The reason
The machine does not act.	<ul style="list-style-type: none"> ● Is there power failure? ● Is the power plug loose? ● Is the pulsator twisted by foreign materials?
The draining does not work	<ul style="list-style-type: none"> ● Is the drain hose frozen? ● Is the drain hose blocked by foreign material? ● Are there laundries falling to the outer side of the spin tub?
There's abnormal sound during washing	<ul style="list-style-type: none"> ● Are there hair pin, coins or metal items brought inside the tub?
There's abnormal sound and violent vibration during spinning	<ul style="list-style-type: none"> ● Is the machine slanting? ● Is the gland pressed evenly? ● Are there laundries falling to the outer side of the spin tub? ● Are the laundries in spin tub too much?
There may be some water flowing out of the drain hose in the first use of the machine.	<ul style="list-style-type: none"> ● It is the water remained in the factory inspection of performance.

Packing list

● User's manual	● One
● Water inlet hose	● One
● Water-filling jointer	● One
● Gland	● One
● Lint filter	● One
● Twin-tub washing machine	● One

Specification

Type	Twin-tub washing machine with pump
Model	HWM60-111P
Power source	Rated voltage 220V~, Rated frequency 50Hz
Water level / Water quantity (about)	Maximum/55L Medium/46L Minimum/36L
Rated washing capacity (kg)	6.0
Rated input power (W)	Wash 320 Spin225
Dimensions(mm)	L810 W460 H890
Wash pattern	New current
Weight (kg)	24.5
Injection pressure	0.02MPa~0.2MPa