

Mini Washing Machine

User's manual

Haier

This manual is for
HWM15-0501

- Please read this manual carefully before using.
- Retain it for future reference.

The Haier logo consists of the word "Haier" in a white, sans-serif font, centered within a dark gray square background.

Haier

0030805760E



Contents

Names of the parts.....	1
Safety precautions	2
Installation and adjustment	4
Preparation before washing	5
Put in the laundries	6
Usage of the detergent.....	6
Process washing.....	7
Disposal after washing	8
Trouble shooting	9
Packing list *Specification.....	10

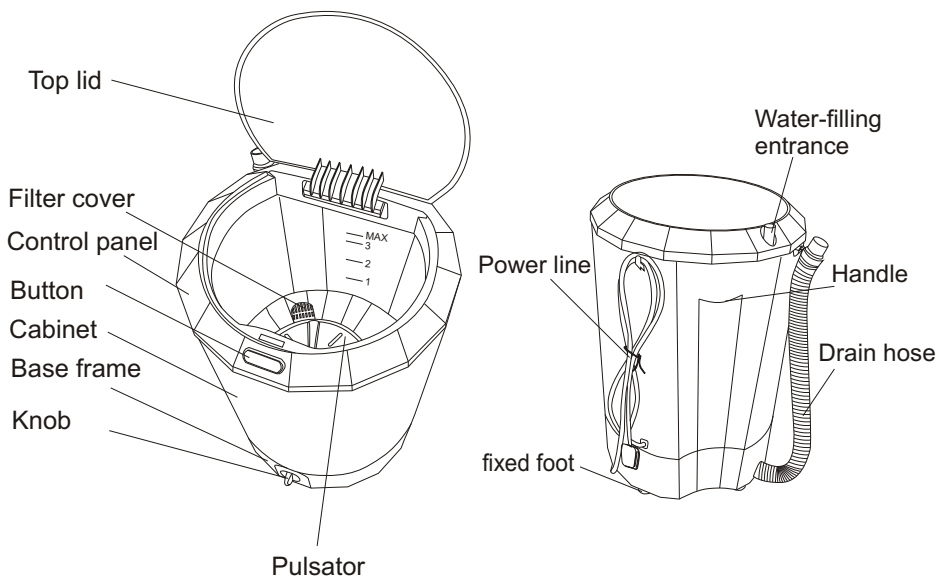
Names of the parts



Meaning and description of the symbols

<p>Warning sign</p> 	<p>Contents marked with that symbol are related to the safety of the product and the personal safety of the users. Please operate in strict conformity to the contents, otherwise it may cause damage of the machine or injure the personal safety of the user.</p>
<p>Forbidden sign</p> 	<p>Contents marked with that symbol are actions forbidden to perform. Performing of those actions may result in damage of the machine or injure the personal safety of the user.</p>

Safety precautions

Please insert the power cord into special receptacle with rated voltage. Be sure to use single-phase three pins receptacle. The earthing terminal of the receptacle must be earthed reliably. If possible, please adopt electric leakage protector.



The power cord plug should be convenient to be plugged in or plugged out with hand while the washing machine runs normally. Be sure to pull the plug out and close the water tap when the machine is idle, when moving the machine, or when cleaning the machine. Do not use wet hand to insert or pull out the power plug.



Do not damage the power cord, bend, extend, twist, bind or alter it by force. Do not press or nip it with weight. If the supply cord is damaged, it must be replaced by the manufacturer or its service agent or a similarly qualified person in order to avoid a hazard. Keep the pin of the power plug clean, if the power plug is polluted with dust, please wipe with dry cloth carefully.



Do not put the machine at damp place like the bathroom. Never wash it with water. Not put wet laundries on the control panel.

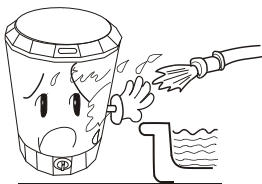

Do not use water hotter above 50°C.



For washing machine with ventilation openings in the base, that a carpet must not obstruct the openings.

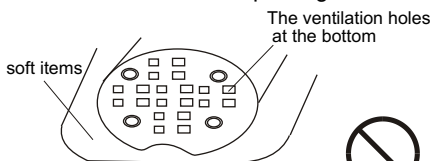

Do not wash water-proof laundries like the raincoat, bike covers etc.



Do not let the machine share one receptacle with other electric appliances. If the power plug is damaged, or the plugging into the receptacle is loose, do not use the plug any more.

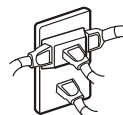

Safety precautions

Do not stretch hands into the working machine. It is dangerous even if the rotation is slow. Take special care of the children. Do not let the children climb the washing machine.



Do not decompose, repair or alter the machine by yourself.



Do not put any hot or heavy items (such as the kettle with hot water) on the washing machine.



Do not wash laundries with volatile materials (such as thinner, petrol etc.)



The handicapped or children without care shall not use the machine.

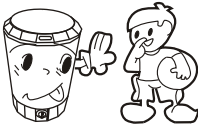

Keep the machine away from direct sunlight and heat source like the heater.

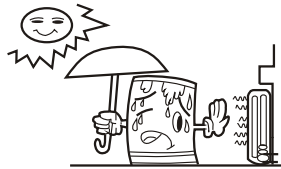

- To protect your laundries and washing machine, please take out all of the coins, buttons, sand, hairpin and other foreign materials before washing.



- Please check if the water faucet is open, and if the connection of the water inlet pipe is proper.
- It is suggested to use foamless washing powder.

Installation and adjustment

Please install and adjust the machine according to the requirement of the manual. It is very important to your security and correct operating the machine.

Usage of the drain hose

The drain hose shall drain smoothly

1. The height of the drain hose shall be less than 10cm, or the drainage will not be smooth, and cost such long time that the machine may stop at mid way.

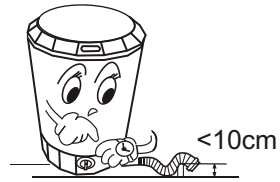

2. Do not trample or press the drain hose.



3. Do not lengthen or cut down the drain hose.

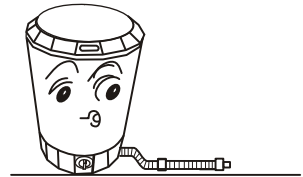



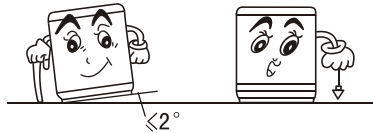

Adjust the installation position

The largest allowed slope of the shank base of the machine is 2° . The slanting or rough ground will result in unstable running or stoppage of the machine, Please adjust it.



Preparation before washing

Pay attention to followings before washing the laundries

<p>Confirm if there's special requirement for the laundries.</p>	<p>Clear the pocket. Take out the coins, sand, hairpins etc.</p> 	<p>Fasten the buttons and zippers.</p> 	<p>The quantity of the laundries shall not exceed the rated value. The big laundries like the jeans shall be put in loosely.</p> 	<p>When the pulsator is running, the buttons of the laundries may cause noise. For the sake of discretion, please put the laundries with buttons into other laundries.</p> 
--	--	--	--	--

- Please check if the laundries are applicable for washing.
- Separate those not colorfast from other laundries.
- For laundries not water absorbing, please put them into water with hands.
- For laundries with much soil, please remove the soil first. You can add detergent on the part with serious soil directly. It is much easier to remove the soil by that mean.
- For laundries likely to get lint ball or with long fiber, please first turn the inside out before putting them into the water.
- Do not put the laundries polluted with chemicals directly into the washing machine.
- For those small laundries, laundries likely to be twisted or worn, and woolen laundries, please put them into mesh bag before washing.

Reference weight of the laundries:



● pajamas
(about 200g)



● shirt
(cotton, about 300g)



● underpants
(cotton, about 70g)



● undershirt
(cotton, about 180g)



● Socks
(blending, about 50g)

Put in the laundries



- The capacity of washing of the machine refer to the largest weight of the standard laundries under dry condition that can be washed in one time. One time washing quantity shall be lower than the rated capacity.
- The thickness, size, type of the cloth will influence the actual washing capacity. It is suitable for one time washing to put in reasonable amount of laundries and the laundries can be turned round in washing.
- Do not select "3" water level for a little laundries, so as to avoid splashing of water.

Usage of the detergent

How to use the whitener

- Fill water to decided level. Dilute the whitener with container. Pour it slowly into the washing tub.
- Avoid using whitener on laundries with color or pattern as they are prone to lose color.
- The whitener shall not touch the laundries directly.
- Refer to the user's manual for the usage and quantity of the whitener.
- For powder whitener, please dissolve it before use.

How to use the washing powder

- Direct dissolved in the machine
 1. Fill water to "1" water level.
 2. Add the power. Run for 30 seconds to dissolve it completely.
 3. Put in the laundries. Select suitable water level.
- The instant dissolving of the washing powder:
 1. Prepare warm water of 30°C and a container.
 2. Add the powder while stirring to fully dissolve it.
- Put in the proper quantities detergent according to the water level and the laundries quantities .
- It is suggested not to use high sudsing detergent.
- Washing powder with poor quality or long time storage maybe caked.

Process washing

1. Put into the laundry and detergent, then fill the water needed.

Install the water inlet hose

Insert the water inlet hose into the water-filling entrance on the control panel. The appliance is to be connected to the water mains using new hose-set and old hose-set should not be reused.

NOTE

1. Confirm that the drain hose is properly hanged before fill water, or the water will flow through the drain hose.
2. Inside the washing machine tubbiness, It be marker reference water line "1", "2", "3" and the top water line "MAX". Not to a certainty over the mark "MAX".

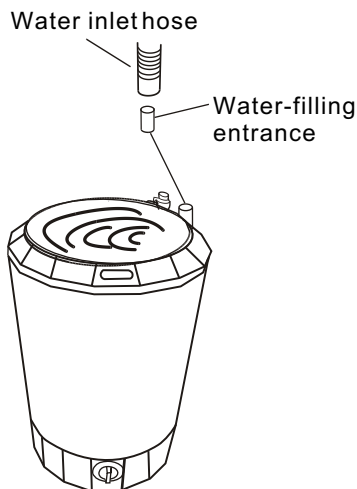

2. Close the top lid

3. Connect the powerline

Confirm that the washing machine is earthed reliably. Then insert the power plug into the receptacle. Do not connect the earth terminal to the gas pipe and tap water pipe.

4. Washing duration reference

Select washing duration depending on the laundry

Laundry	Washing Duration(min)
Silk fabric(thin laundry)	About2~4
Knitted fabric/chemical fabric	About3~6
Bed sheet	About7~8
Cotton, blending or linen fabrics	About8~10
Very dirty or heavy laundry	About10~15

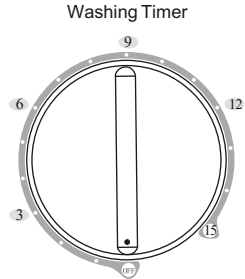

(To set to below 2 minute, first set to 6 minute then turn it back, it can increase the service life of the timer).

5. Finish washing

- The tumbler stops revolving. Level the draining hose down to let the waste water out.

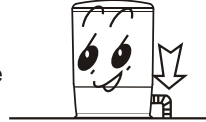

Disposal after washing

- After washing, close the water faucet. (If needed, you can dismantle the water inlet hose).
- Do not store water in the washing machine for a long period. Drain the water completely after each using.
- Be sure to pull off the power plug before maintenance.
- Hang up the power cord and drain hose.
- Wipe off the water drops on the surface of the machine and inside the tub. Open the top lid for some time (about 1 hour), then close the top lid.

If the cabinet is dirty, wipe it with wet cloth

- Do not flush it directly with water.
- Wipe it with neutral detergent.
- Do not wipe it with thinner, petrol, alcohol etc.



Trouble shooting

(If there's breakdown, please pull off the power plug before checking) The following phenomena are not breakdowns sometimes. Please confirm again before sending it to repair. If there are real breakdowns, please come to the special maintenance department or after-sale service department of our company. Do not repair it by yourself.

Phenomena	How to check
The washing machine does not act.	<ul style="list-style-type: none">● Is there power failure?● Is the power plug inserted tightly?
There's abnormal sound inside the machine.	<ul style="list-style-type: none">● Is the machine slanting?● Is there metal item inside the tub?
The drainage does not work.	<ul style="list-style-type: none">● Is the drain hose put down?● Is the front end of the drain hose blocked?

Packing list

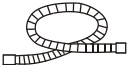
Name	Quantity
● User's manual	● One piece
● Water inlet hose 	● One piece
● Mini washing machine	● One set

Specification

Water level/ Water quantity (L)	3: 17 2: 12 1: 7
Water inlet pressure (MPa)	0.02~0.2