

1.Contents-----	1
2.Features -----	3
3.Sale points-----	4
4.Specification -----	5
5.Safety-----	7
6.Installation -----	9
7.Maintenance-----	11
8.Net dimension -----	13
9.Names of the parts-----	14
10.Operational Functions-----	15
11.Trouble shooting-----	17
12.Wiring circuit -----	23

Haier

FRONT LOAD WASHING MACHINE

Service Manual



Suited model:

**HW-DS1050TVE
HW-DS850TVE**

Features:

- 300mm diameter porthole, door may be open at a 180 degrees.
- Class-A energy-saving; Homocentric tubs with higher energy efficiency
- Multi-gear speed controller
- Unique gasket design featuring no residual water hidden inside
- Delay time adjustable
- Large wash load capacity 5kg
- With AQUA STOP inlet hose, further improve the grade of safety

FEATURES

- 300mm diameter porthole, door may be open at a 180 degrees.

Facilitate view of wash process, facilitate unloading and easy to use with large port.

- Class A energy-saving,Class B washing performance

Scientific design for tub can reduce the use of water heavy during washing, consequently upgrade the energy efficiency class to A,also use scientific washing in order to getting class B washing performance.

- Multi-gear speed controller

According to different costuming, you can select corresponding spin speed, from 400 to 1000 rpm.

- Unique gasket design featuring no residual water hidden inside.

By the unique gasket, washing machine can left no residual water hidden between outer drum and front board.

- Delay time adjustable.

According to different costuming, you can select delay time, from 0.5h to 24h.

- AQUA STOP

Using AQUA STOP inlet hose, you will never be worried about water overflow.

Sale points

One sentence for simplicity:

Tight machine body without any wasting places

Three sentences for convenience:

- I. Choose from 11 programs, convenient uses to provide you much benefit
- II. Front-Load structured to ensure placing clothes much more facility
- III. Humanistic design for control panel to help expedient operation

Five sentences for tech-support:

- I. No need to be worried because of the function of intelligent-memory
- II. Satisfied to encourage children's curiosity because of the child-lock
- III. Perish your trouble because of the alarm to the fault
- IV. Make you happy because of quick-wash in 29 mins
- V. Reassure for you because of the 24hours pre-wash which may offer you washing anywhere and anytime.

SPECIFICATION

	<i>Proposal</i>	2006	New Sensor
	Front load washing machines		HW-DS1050TVE HW-DS850TVE
1.	Product identification		
	Description of appliance		Washing machine
	Type of appliance (FS = standing, BI = built-in)		FS
	Supplier own brand		Haier
	Supplier bar code	EAN	TBC
	Mares computer code		-
	Commercial Brand / Model		Haier
	Commercial bar code	EAN	Haier
2.	Key-Features		
	Energy efficiency class		A
	Washing performance class		B
	Spin efficiency class		C
	Programs	n°	11
	Capacity	kg	5
	Spin speed (max. / optional)	rpm	1000-400/800-400
	Noise level	dB(A)	62
	Energy consumption per wash circle *	kWh	0.94
	Water consumption*	l	59
	Residual dampness (spin result)	%	63%
	Spin speed selector switch (steps)	rpm	●
	Spin speed variator (stepless)	rpm	●
	Adjustable thermostat (water temp. adjust from - to)	°C	90/60/50/40
	Drum capacity dry laundry / water	kg / l	5/ 59
	Auto water level adjust (depending on volume of filled in laundry)	AWL	●
	Washing time (max.)	min	152(TBC)
	Certification's (CE / ISO 9001 / ISO 9002)		CE / ISO 9001
	Approvals (VDE/GS / TÜV/GS / IMQ)		TÜV/GS (Rhl.)
	* EN 60456 (60°C cycle, full load without pre-wash) *≠ COLD		●
3.	Basics data		
	Unit dimensions (H x W x D)	cm	85 x 59,5 x 40
	Net weight	kg	63
	Voltage/frequency	V/Hz	220-240V~50Hz
	Input power / main fuse (intensity)	W / A	2000/10
	Work top / removable		●/●
	Control M = electromechanical, E = electronic, F = fuzzy		E
	Inner cylinder S = stainless steel / Z = zinc coated		S
	Outer cylinder P = Plastic / S = stainless steel		P
	Door:		
	aesthetic (R = round, Y = big eye, Q = square)		Y
	Diameter	cm	30
	Outer door frame S= stainless steel / M = metal / P = plastic		P
	Inner door G= glass / P= plastic		G
	Detergent compartments	n°	3
	Removable compartment for liquid detergent		-
	Delay timer (from - to)	h	0.5-24
	Self cleaning suds pump		●
	Water inlet hose cold water / hot water		●
	Water drain hose / -support		●/●
	Adjustable feet	n°	4
4.	Safety systems		
	Auto door lock	ADL	●
	Motor overheating protection	MOP	●
	No heating without water	NHW	●
	Auto water cool-down (before drain 90°C boiled water)	AWC	●
	Water return protection	WRP	●
	ACQUA Stop kit		-







	Child protection		●
5.	Programs		
	1) Strong action /cotton cycles	n°	1
	2) Normal action / synthetics	n°	1
	3) Delicate action / wool cycles	n°	1
	Pre-wash / wash		●/●
	Quick wash / super quick wash		●/-
	Rinse / soften		●/●
	Delicate / hand wash		-/●
	Wool / cashmere		●/-
	Soak / spin		●/●
	Drain		●
	Easy ironing		●
	Optional function keys (additional program settings)		
	ON/OFF button		●
	Delay		●
	Extra rinse button		●
	Spin exclusion		●
	Spin reduction	rpm	-
	High water level		●
	Rinse hold		●
	Child lock		●
	Delicate		-
	Cold wash	❄	●
	Load selection		●

● Stand for having the function

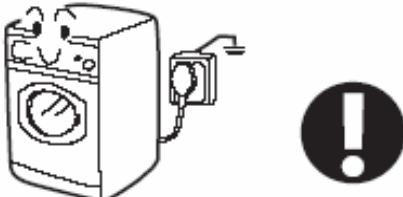
- Stand for not having the function

Matters Needing Attention

Safety

<p>1. A separate earthed socket is required for the power supply. The socket should be reachable by the power cable of the machine.</p> 	<p>2. Hold the plug and not the electric cable when unplugging the power supply.</p> 
<p>3. Fuses in the power circuit should be rated for 15A.</p> 	<p>4. Do not touch or use the washing machine bare-footed or when the hands or feet are wet.</p> 
<p>5. Do not use flammable detergent or dry cleaning agent; do not use flammable spray in close vicinity to the washing machine; do not remove or insert the plug in the presence of flammable gas.</p> 	<p>6. The door of the washing machine will become hot during the heating process. Avoid contact with the door during the heating process.</p> 
<p>7. Keep children away from the packing materials after unpacked.</p> 	



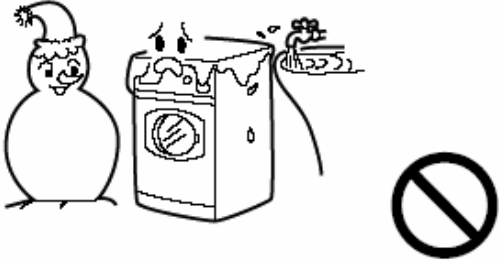
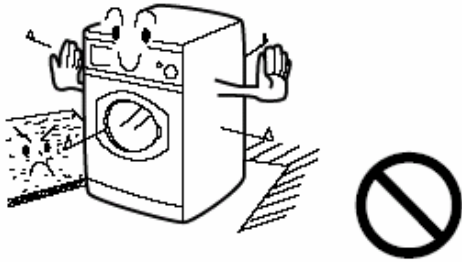
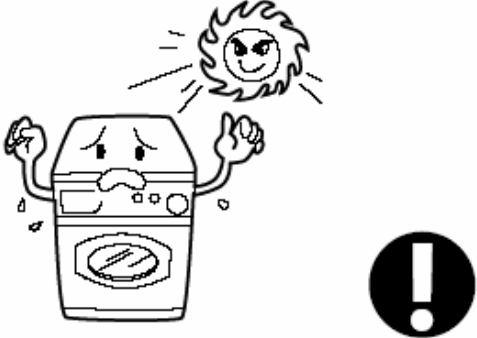
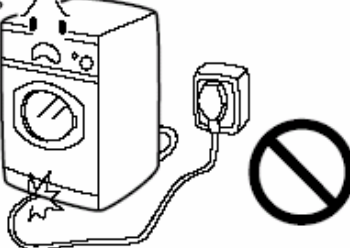

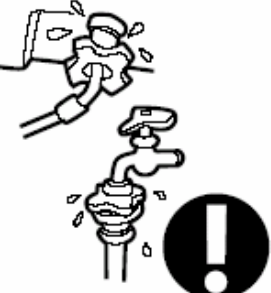
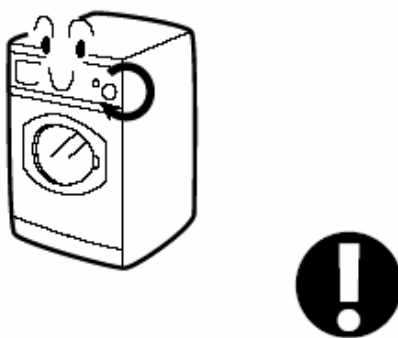

Matters Needing Attention

<p>8. The washing machine should not be installed outdoors or in a damp place. In the event of water leakage or splashes allow the machine to dry naturally.</p> 	<p>9. Do not place the washing machine directly on a carpet, or close to a wall or furniture.</p> 
<p>10. Keep away from heat sources and direct sunlight to prevent plastic and rubber components from aging.</p> 	<p>11. During installation, ensure that the electric cable is not trapped by the washing machine and avoid damage to the electric cable. If the supply cord is damaged, it must be replaced by the manufacturer, its service agent or similarly qualified persons in order to avoid a hazard.</p> 

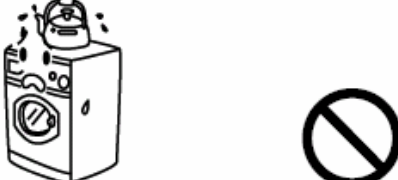
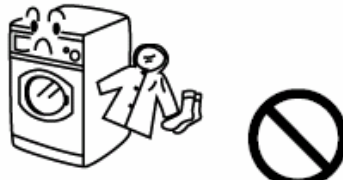
● During Use

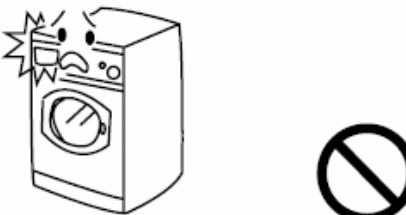
<p>1. Before use, check the joints of the filling hose, the tap and the drainage hose for possible problems from water pressure fluctuations. If joints are loose or there is leakage, turn off the tap and repair. Do not use the washing machine until the hose are properly fixed.</p> <p>Note: That the appliance is to be connected to the water mains using new hose-sets and that old hose-sets should not be used</p> 	<p>2. To select a program, simply turn the knob clockwise or counterclockwise.</p> 
---	---

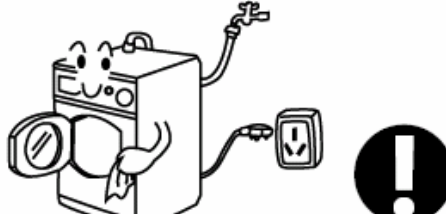
Matters Needing Attention

<p>3. Do not place heavy, heating source or wet articles on the top of the washing machine.</p> 	<p>4. Do not hot wash foam rubber or sponge-like materials.</p> 
<p>5. Before washing, do up zippers, buttons and clothes straps and put small articles, such as socks, laces or bras, into a washing bag or a pillow.</p> <p>Steel wires in bras will pop out during washing; never wash bras containing steel wires.</p> 	<p>6. Do not open the detergent distribution drawer during the wash cycle.</p> 
<p>7. The door is fitted with a self-lock device and will not open until 2~3 minutes after the washing machine stops. Do not force the door open. Do not open the door if water level can reach the porthole.</p> 	<p>8. After each wash program, turn off the tap to prevent leakage; and unplug the washing machine and wipe clean the lower part of the porthole.</p> 
<p>9. Keep the door slightly open when the washing machine is not in use to prevent formation of odors; do not cover the washing machine with plastic cover so that inside dampness cannot be kept in.</p> 	

Installation

- Remove all the packing materials to prevent vibration during use. Upon opening of the package, water drops may be seen on the plastic foam and the porthole. This is normal phenomenon resulting from water test in the factory, as shown in Fig 1.

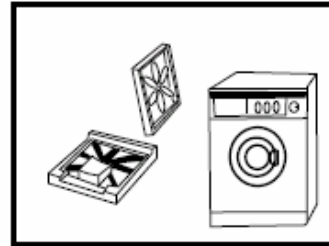

Fig. 1

- Dismantle the packing bolts as shown in Fig. 2. The packing bolts are designed for clamping anti-vibration components inside of the washing machine during the transportation process. Before use:

1. Remove the back plate;
2. Remove the three packing bolts on the back plate and take out the rubber hose;
3. Replace the back plate;
4. Fill the holes left by the packing bolts with plastic plugs.

(Attention: The packing bolts and rubber hose should be kept in a safe place for later use)

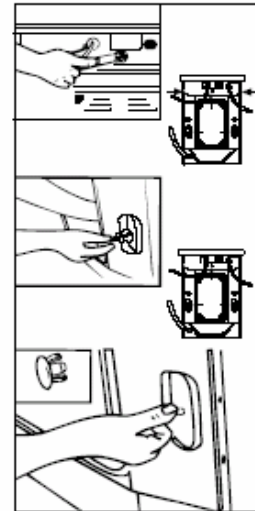

Fig. 2

- Adjusting the washing machine

There are adjustable feet under the bottom of the washing machine. Before use, the washing machine should be adjusted, as shown in Fig. 3, so that it is level.

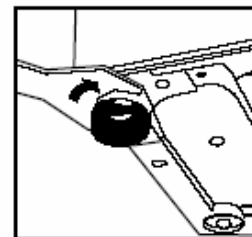
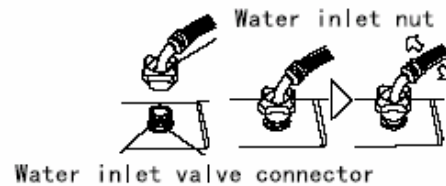

Fig. 3

Installation

Joining the Inlet Hose to the Washing Machine

1. Connect the nut on the inlet hose to the connector on the water valve.
2. Tighten the nut to secure the hose



Drainage Hose

- The height of the drainage outlet must be 80–100 cm. To prevent the drainage hose from dropping off, fix it to the drainage hose clip at the back of the washing machine.
- Use the drainage holder to keep the end of the drainage hose retained and prevent the outflow of water. It is recommended that the length of the drainage hose not be increased; if an increased length hose is required, please consult a serviceman. The additional hose should be no more than 250cm (overextended hoses could lead to siphonage). Note: The drainage hose should not be submerged in water and should be securely fixed and leak-free.

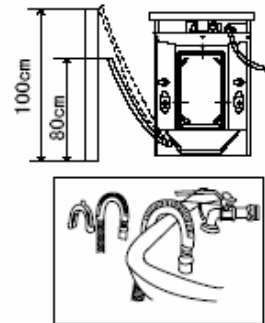

Connecting to the Power Supply

Before connecting to the power supply, check:

- The socket is adequate for the maximum power of the washing machine (For safety, fuses in the power circuit should be rated for no less than 15A).
- The voltage should meet the requirement.
- The power outlet should be capable of accepting the washing machine plug. The washing machine must be earthed before use.

Maintenance

1. Turn off the water tap and pull out electricity plug after each wash. Open the porthole to prevent formation of moisture and odors. If the washing machine is left idle for a long period, drain the water in the machine and replace the drainage hose.

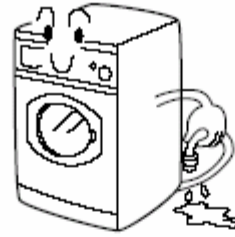

2. Unplug the machine during cleaning and maintenance. Use a soft cloth dampened with soap liquid to clean the machine case and rubber components. Do not use organic chemicals or corrosive solvents.

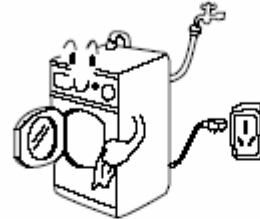

3. Clean the detergent distribution drawer regularly.

Swing out the drawer, flush it clean with water and then replace it.

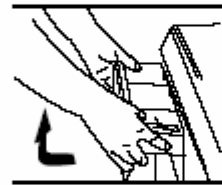

4. Clean the filter Cleaning methods (once a month)

- 1) Push out the outer cover (Fig. 1);
- 2)Screw out filter by turning counterclockwise (Fig. 2);
- 3) Flash clean with running water;
- 4) Replace the filter by turning clockwise and remount the cover.(Fig .3)

Caution: The filter must be turned clockwise to one suitable place, make sure it does not lead to leakage.

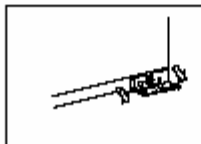

Fig1

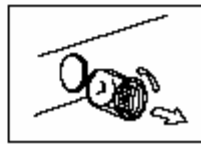

Fig2

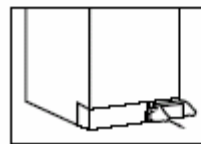
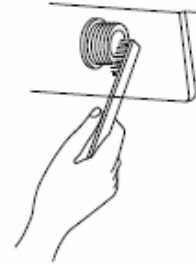

Fig3

Maintenance

5. To prevent blockage to the water supply by ingress of foreign substances, clean the water inlet and inlet filter regularly.



6. If the machine is to be moved to a distant place, replace the vibration absorbing locks (packing screws, rubber gaskets) removed before installation to prevent damage as shown below.

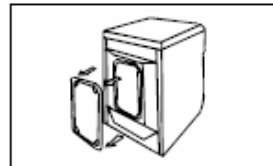

Remove the back cover and take out the three rubber plugs.

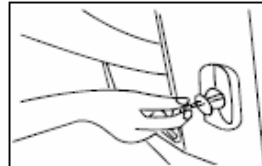

Insert the channel steel vibration locks

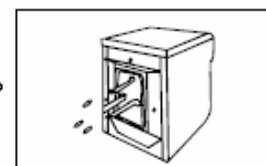

Insert the rubber bolt gaskets.

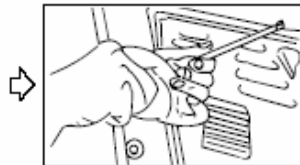

Replace the back cover.

7. If the washing machine is left idle for a long period, pull out the electrical plug and turn off the water tap. Open the door to prevent formation of moisture and odors. Let the door open while not used.

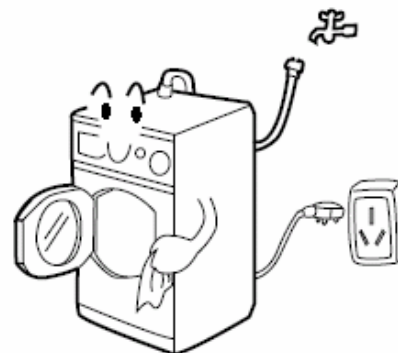

Net dimension



Names of the part



Control panel

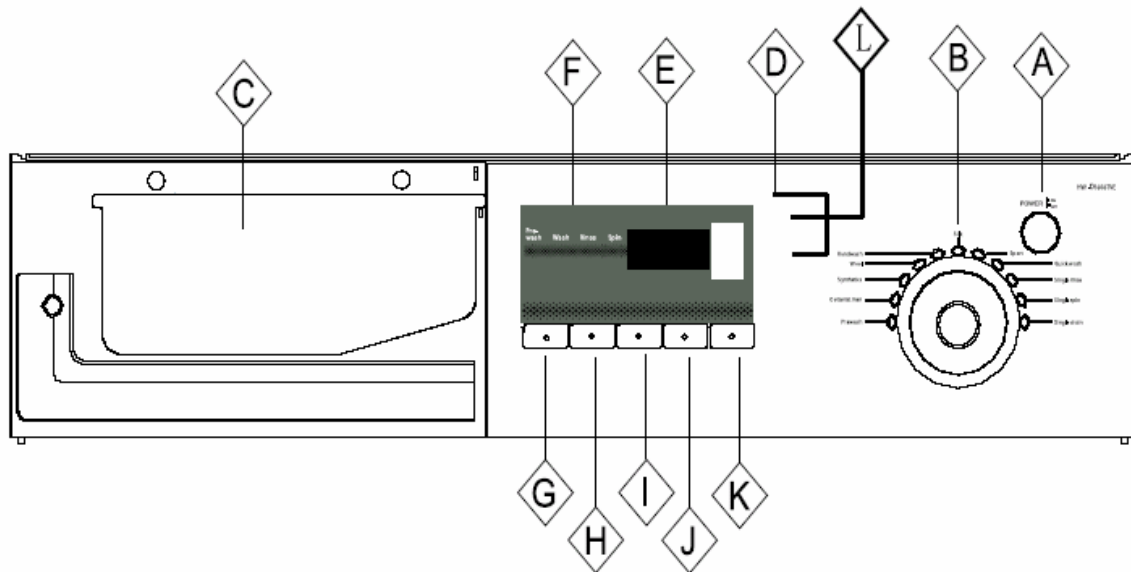

Operational Functions

A : Power Switch

Press this button to switch on the washing machine. Press it again to switch it off.

B: Wash programming knob

By turning the knob clockwise/counterclockwise, the required program can be selected.
(Refer to Guide to Operational Program Selection).

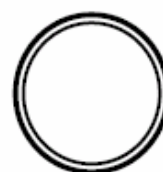

C : Detergent distribution drawer

Open the drawer, three compartments can be seen:

Compartment 1: Pre-wash detergent

Compartment 2: Normal - Quick wash detergent

Compartment 3: Softener, conditioning agent, perfume, etc.

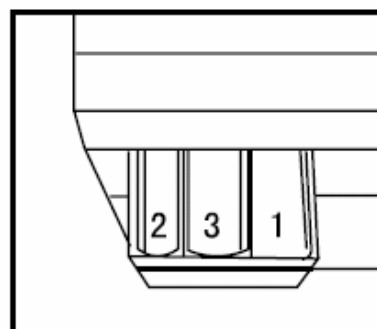

D: Washing temperature keystroke

Touch this button lightly to select the required temperature (when a temperature is selected, the corresponding indicator will go on).

E : Display

Such information as remaining wash time, temperature and speed setting and error messages will be shown.

Note: After power is switched on, the display will go on and the remaining wash time decreases. As the water pressure and temperature may differ, the remaining time may be adjusted accordingly. When the laundry is not balanced during spinning, the time may be automatically prolonged. These are normal phenomena.

F : Washing indicator

It indicates the washing process of the selected program. When the light is on, it shows that the washing process being indicated is running.

G : Delay Button

Touch this button lightly, the washing machine will start operation after a period of time and the corresponding indicator will go on. The range is 0.5-24 hours; each touch of this button increases a half hour. After the button is set, press the Start/Pause button to start countdown of the set time (the time is displayed on the screen until the program ends).

Note:The delay time must be longer than the program time;otherwise,the washing machine will start the wash program directly.

H : Extra rinse button

Touch this button lightly, the indicator will go on. An additional rinse operation will be activated.

Note: Select this function when programe 1-6 or 9 is selected.

I : Rinse hold button

Touch this button lightly, the overhead indicator will go on. When the washing machine is at the last rinsing operation, it will not drain but to start a soaking cycle. Now "hold" will appear on the display. If you want to spin the laundry, press this button again, the indicator will go off and operation will resume.

Note: Select this function when "prewash","cotton&linen","synthetics" "single rinse" is selected.

J :  Time button

Before a washing program, press this button to set the required washing load (L--1~L--A), the washing machine will automatically adjust the water consumption, heating time and washing time.

Users can select the washing load as required for economical operation.

Note: 1. "L 1--A" refers to the five levels of washing load. If the laundry is more than half of the drum content, it is recommended to select L--4 ~ L--A; otherwise, select L--1~L--3.

2.For"synthetics","sport" and "quick wash" ,you can only select L--1~L--3

3. Please adjust the detergent quantity as per the washing load selected

K : Start / Pause button

When the washing machine is plugged and a program is selected, lightly touch this button to start operation. During a wash cycle, touch it lightly, the display will begin blinking and operation will stop. Touch it again to resume operation.

L : Spinning speed setting button

Touch this button lightly to select the desired speed. There are speed indicators over this button.

For knitted sweater and other laundries, if washing machine doesn' t spin, please rechoose the spin program.

Note: Please refer to Guide to Operational Program Selection and Washing Instructions for the required washing temperature and spinning speed for different laundry. If you have no specific requirements, please use default settings.

Special Functions

1. Control panel lock function: To prevent children from accidentally changing the settings. Press "Delay" and "Start/pause" at the same time, this function will work and the "Lock" sign and the remaining program time will appear alternatively. When this function is on, all other buttons are locked. Press the two buttons again to unlock.

2. Power-off memory function: This machine has power-off memory function. In case of abrupt power failure or the power must be cut off during a program cycle, the present settings will be saved and the preset operation will resume when the power is on again.

HW-DS1050TVE Error Display and Troubleshooting



Error message:Door is not properly shut 20s after program is started.

Troubleshooting:

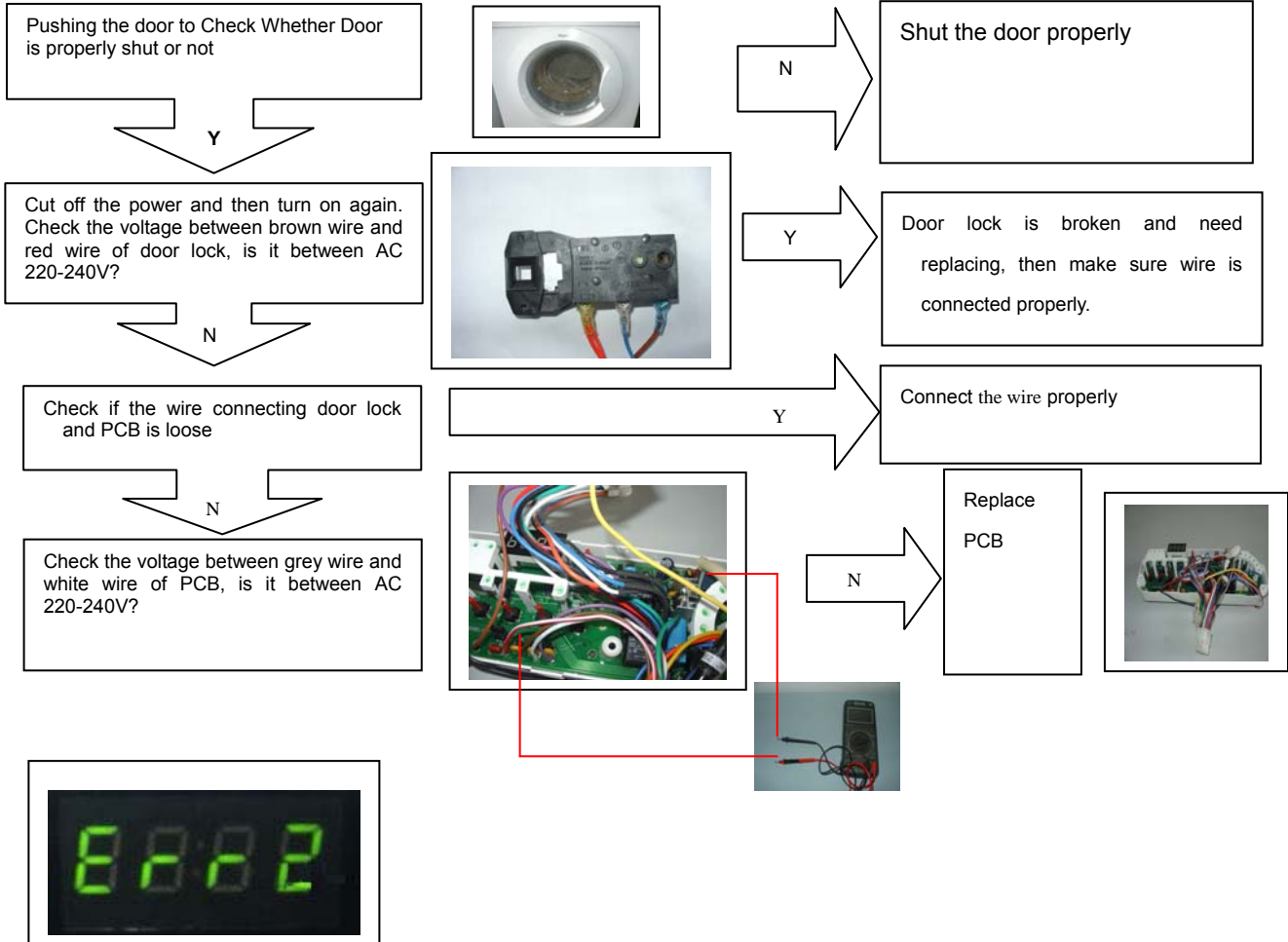

Error message:Drainage error, water not emptied within 4 min.

Troubleshooting:

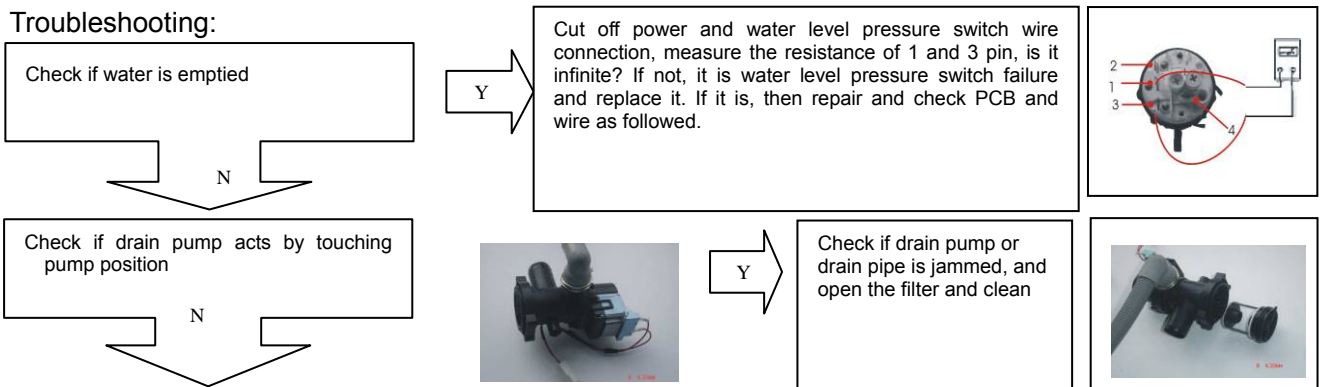

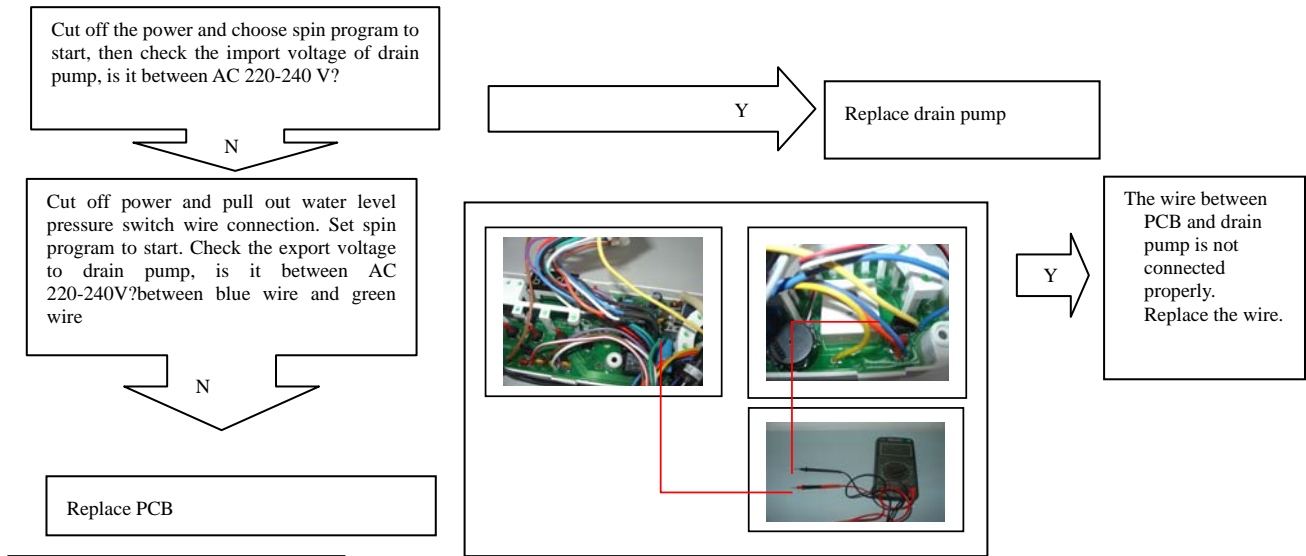

(Fig1)

Error message:Temperature sensor is not properly connected or damaged (display at the end of a program).

Troubleshooting:

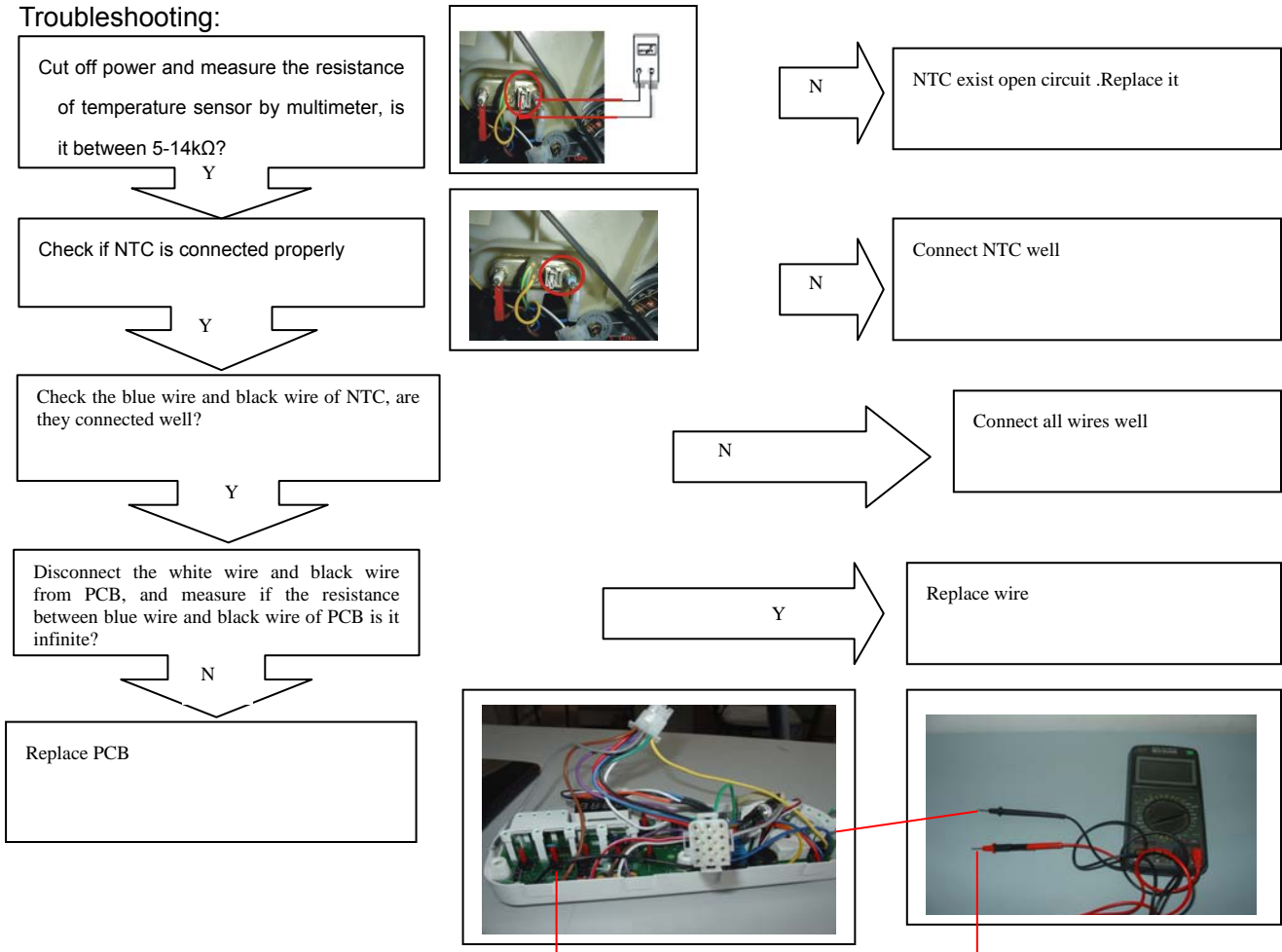



Error message :The heater may be broken

Troubleshooting:

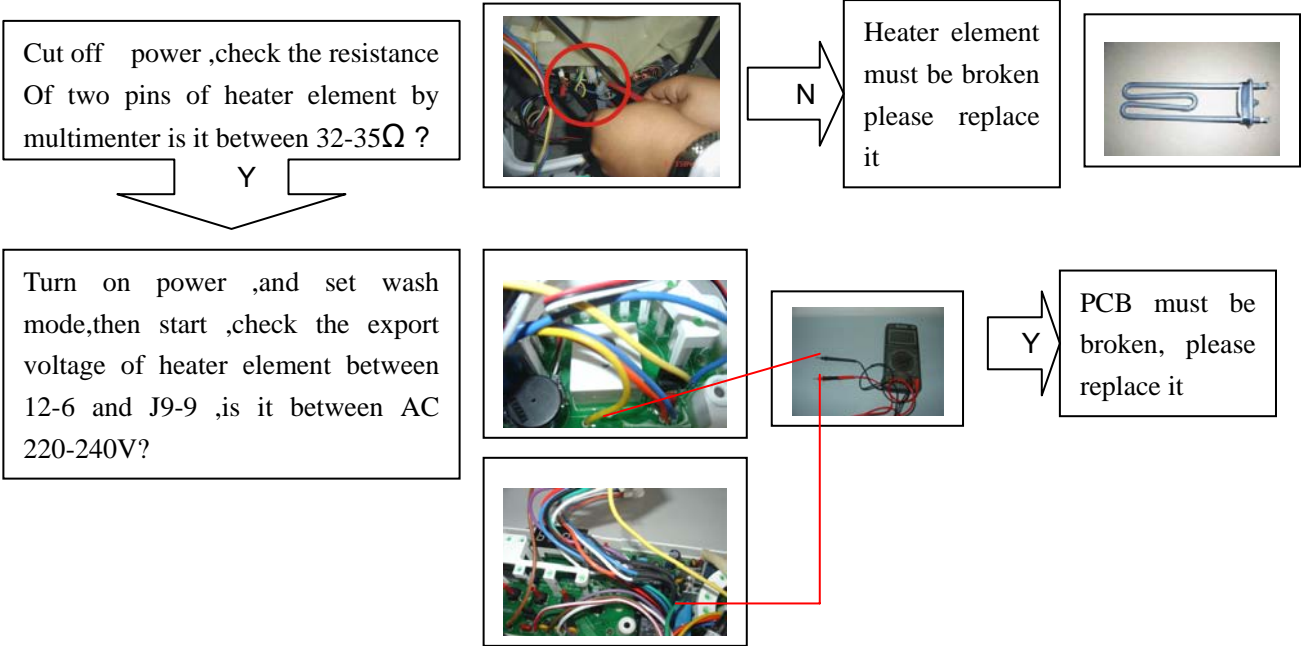

Error message:The required water level is not reached within 8 min.

Troubleshooting:

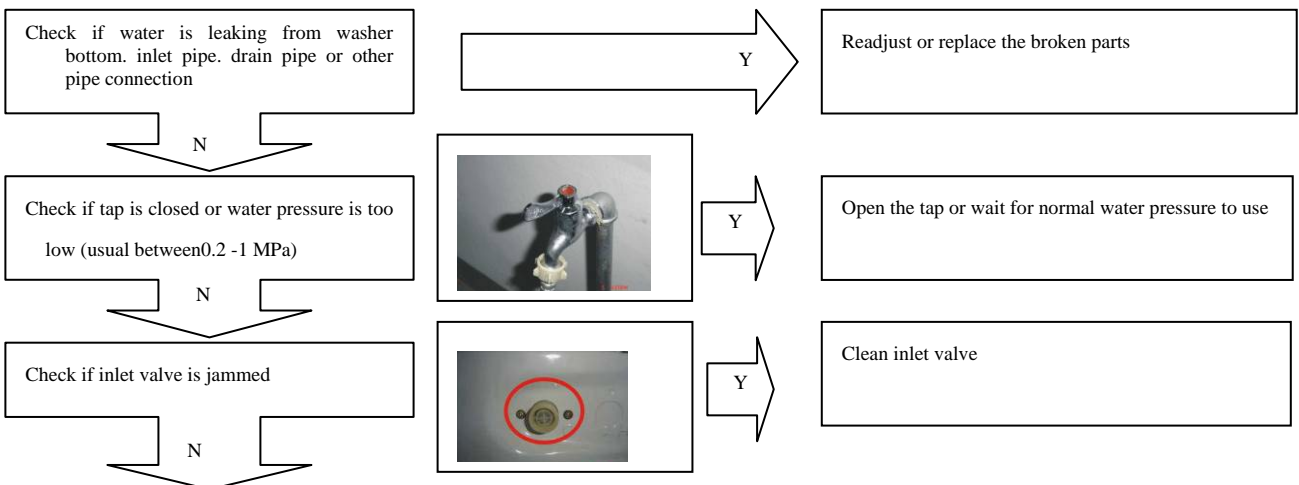

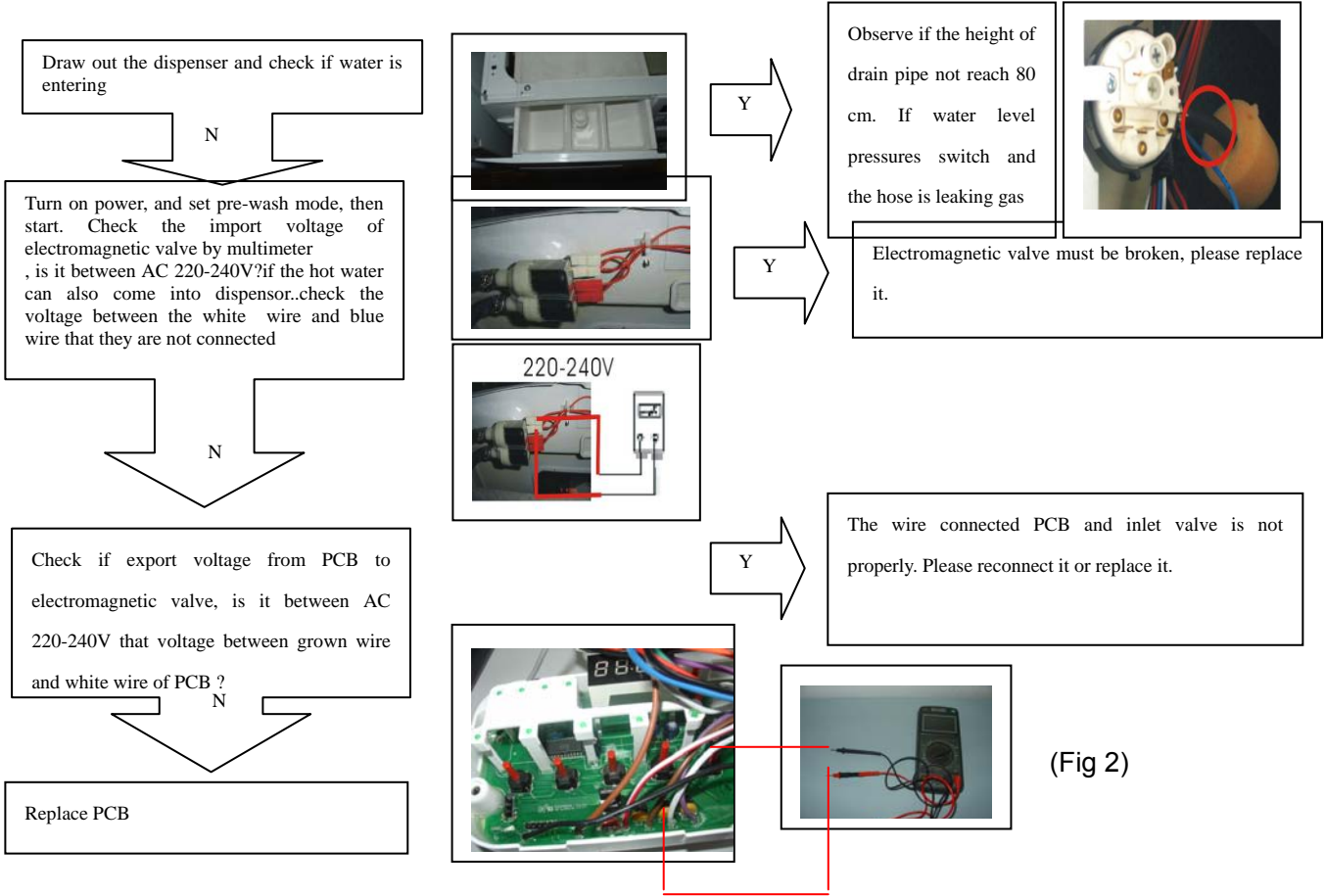

Error message:Motor speed error .it may be not properly connected or damaged.

Troubleshooting :

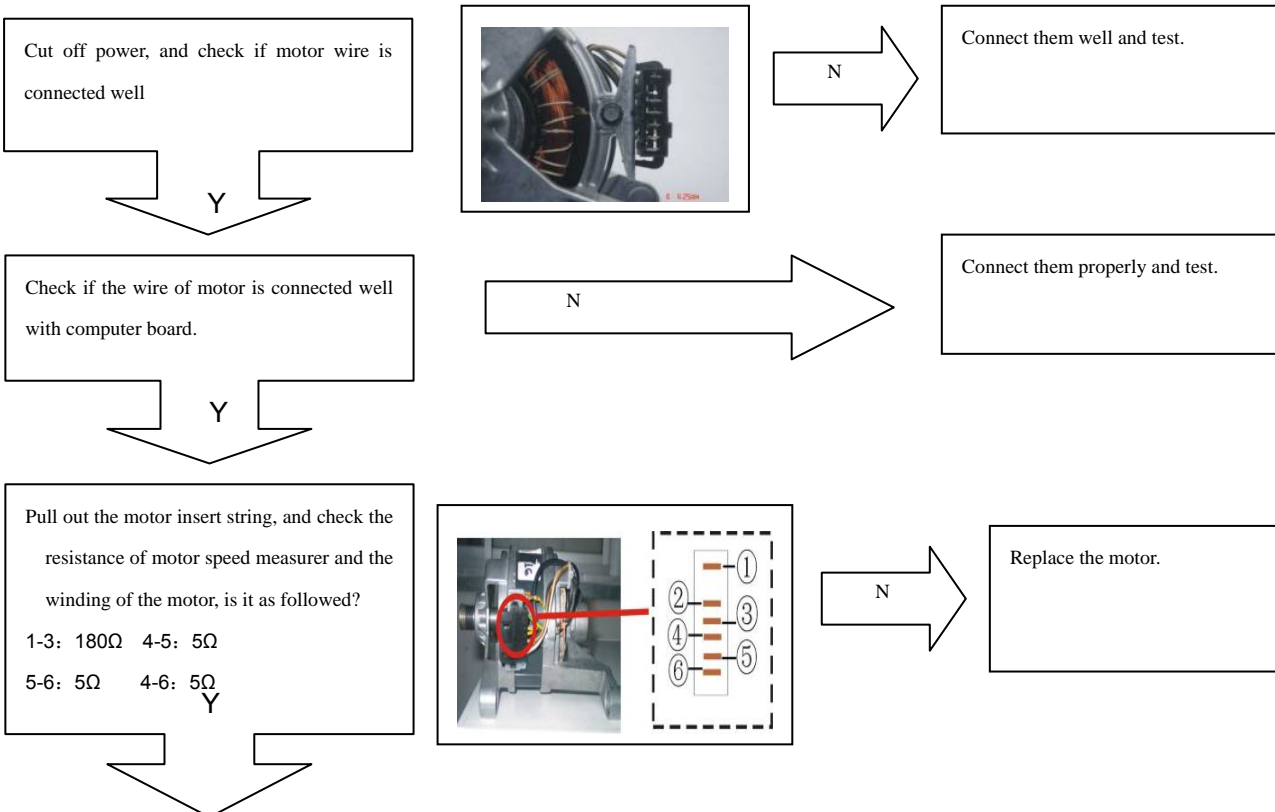

Check the import voltage between M1 wind and M2 wind, is it between AC 220-240V?

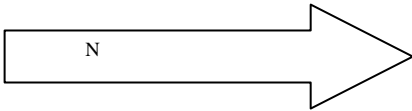

Replace computer board



Error message. Motor overheat protection or is damaged.

Troubleshooting:

Cut off power and check if motor wires are connected well

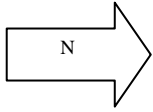
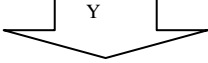

Reconnect well

Measure if resistance of motor winding by multimeter, is it as followed? 4-5:5Ω
5-6:5Ω 4-6:5Ω

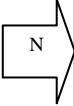
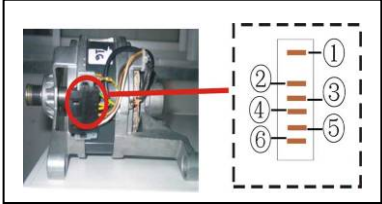
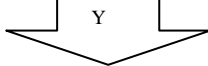

Put the motor in normal temperature about ten minutes, and then test again. If the resistance is normal, it is caused by overheat protection. Then check and deal with overload, abnormal voltage. If not, please replace motor

Pull out the wire connection of motor and computer board. Then check if circuit is open by multimeter

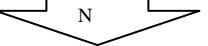

Y → Repair wires

Turn on power and set spin mode, then start. Check the import voltage of driving board between red wire and red wires, is it between 220-240V?

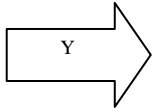

Replace computer board



Error message. Water level exceeds protection value.

Troubleshooting:

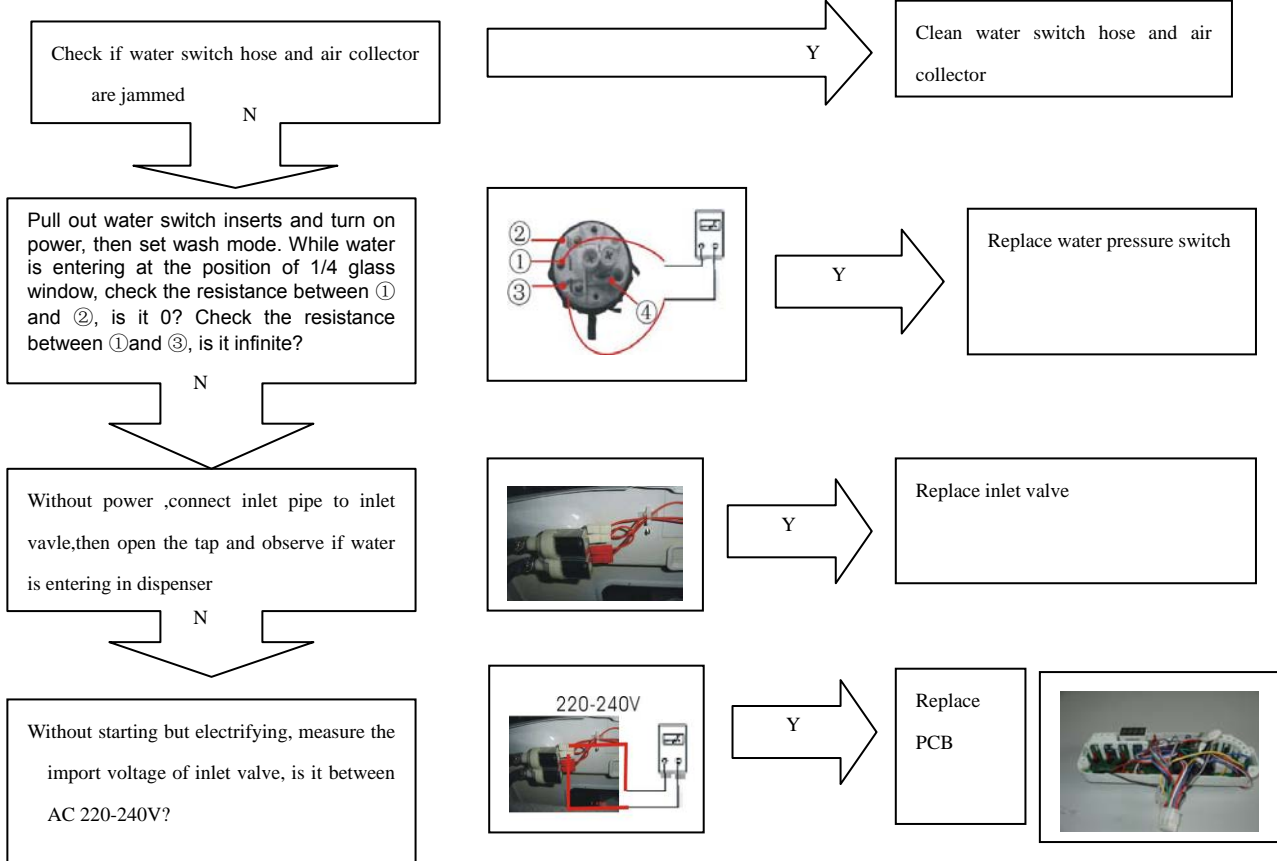

HW-DS1050TVE Examination & Troubleshooting

Failure: Display nothing

Troubleshooting:

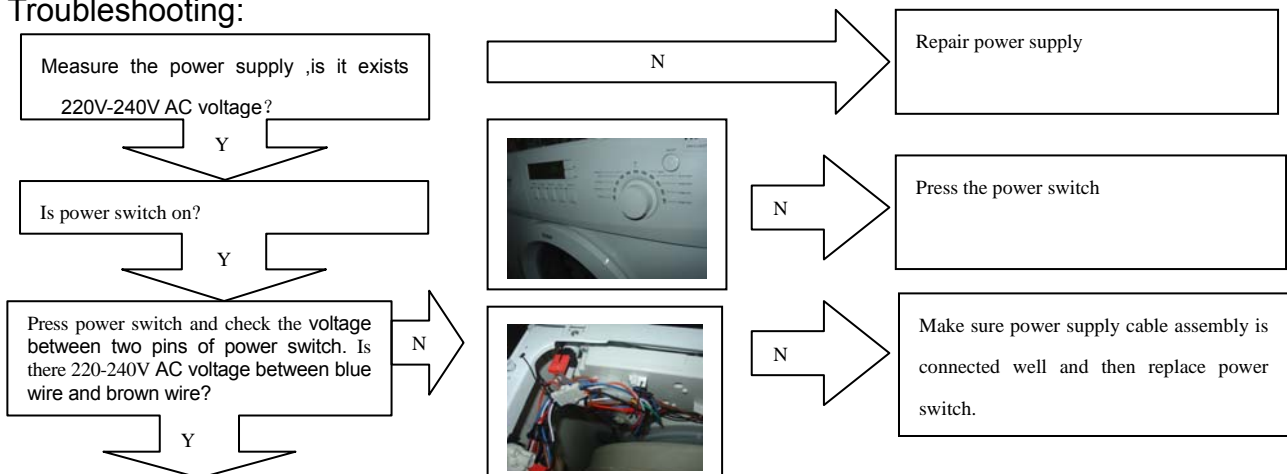

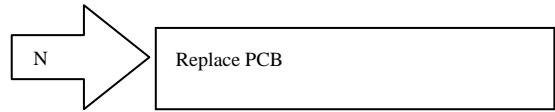
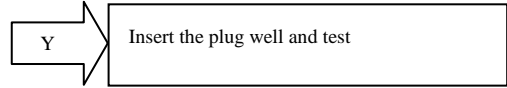
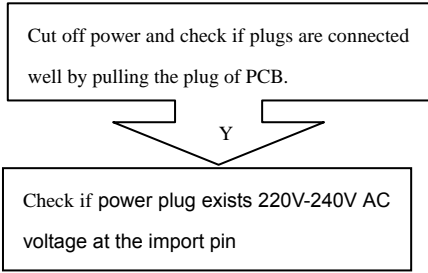

**Failure:no water inletting
Troubleshooting:**

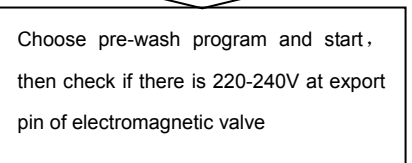
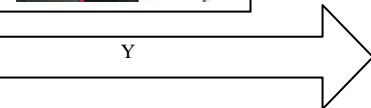
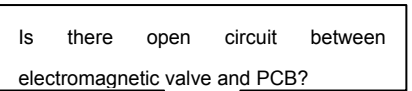
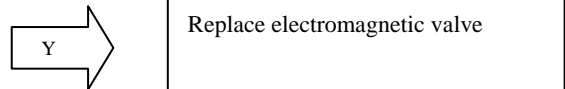
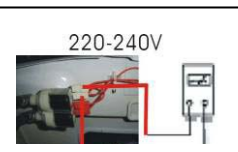
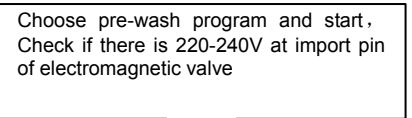
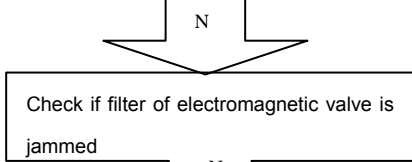
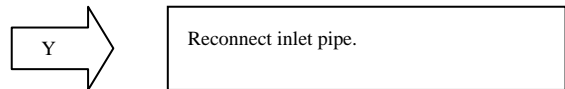
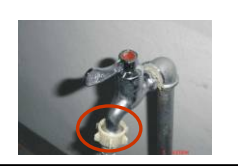
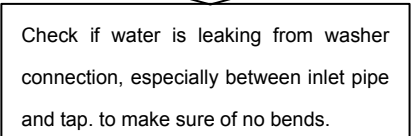
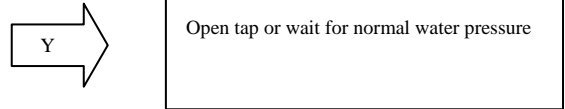
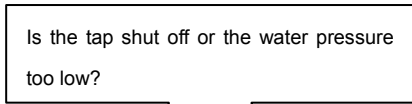

(See fig 2)

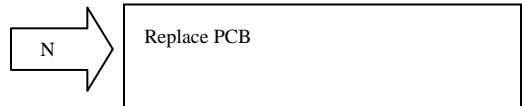

**Failure:no draining
Troubleshooting:**

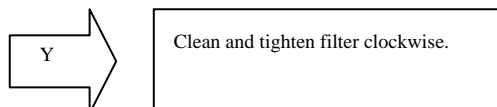
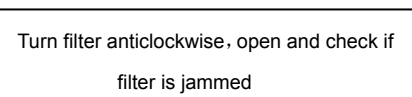
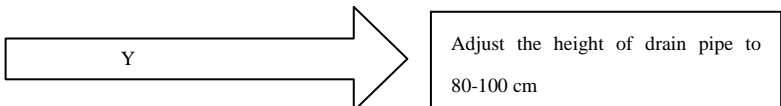
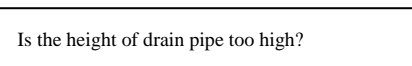

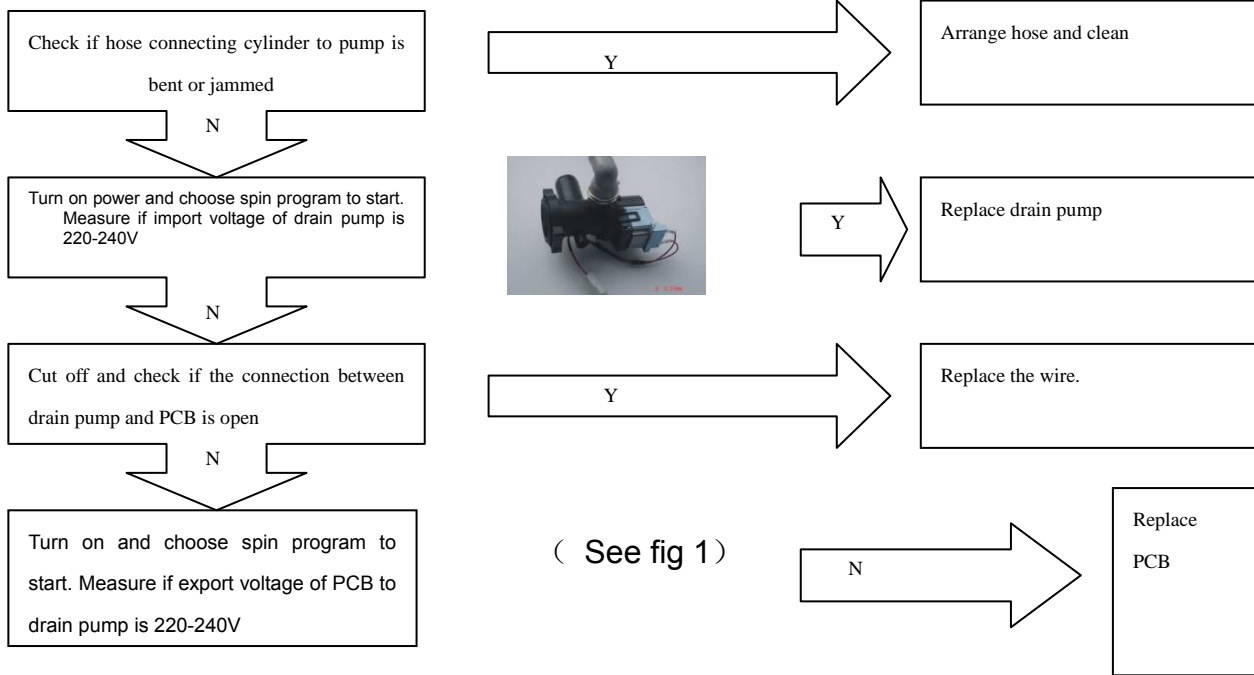

Failure :abnormal noise and vibration

Troubleshooting:

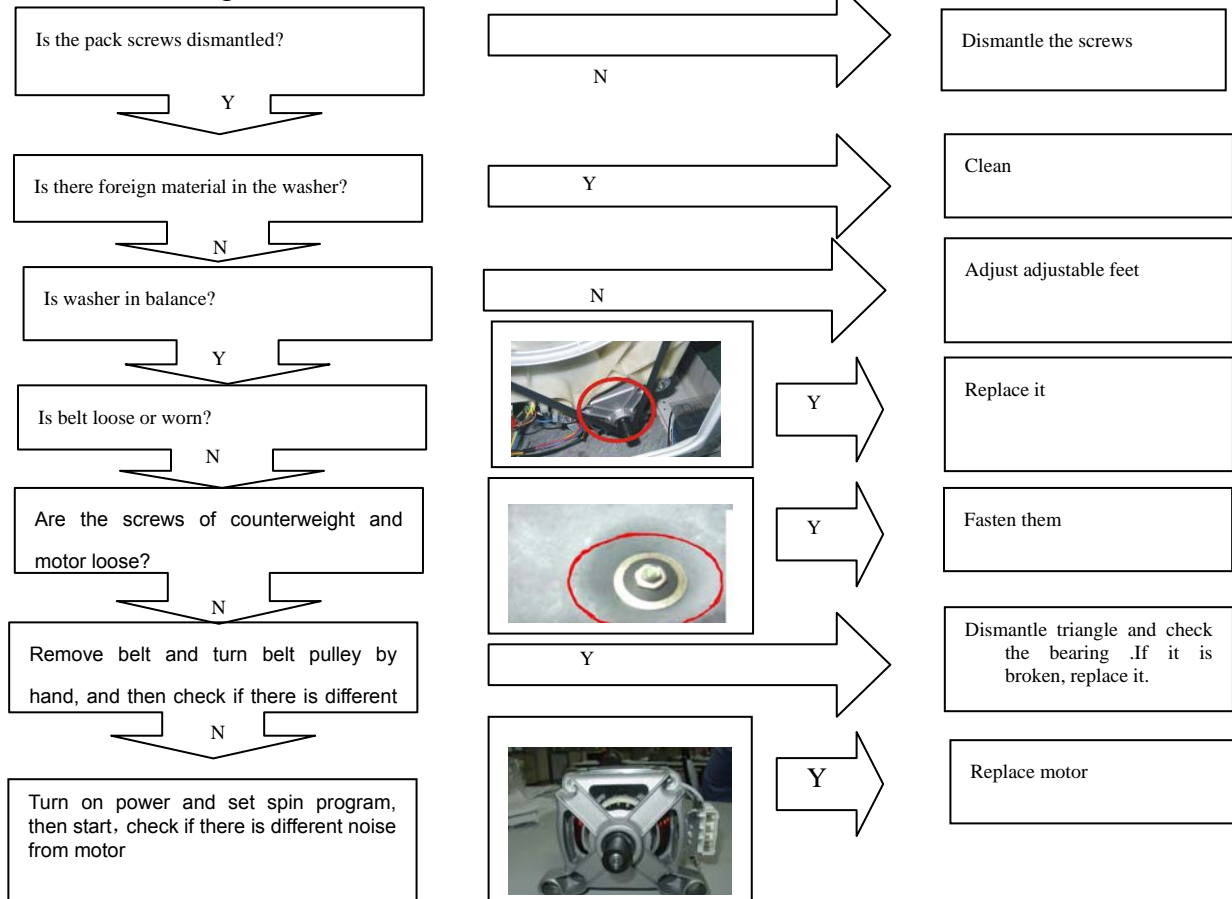

Failure:water leaking

Troubleshooting:

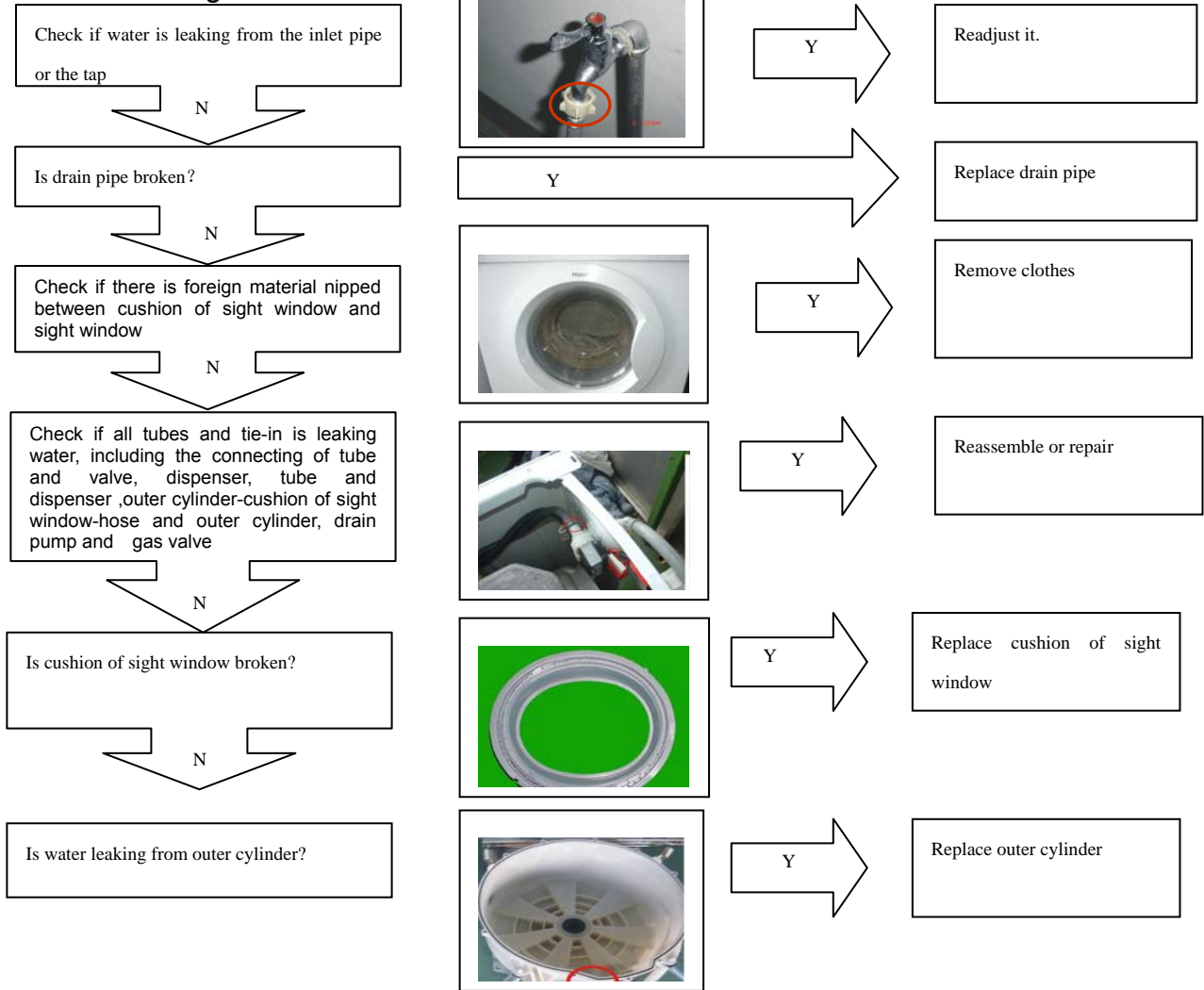

Wiring circuit

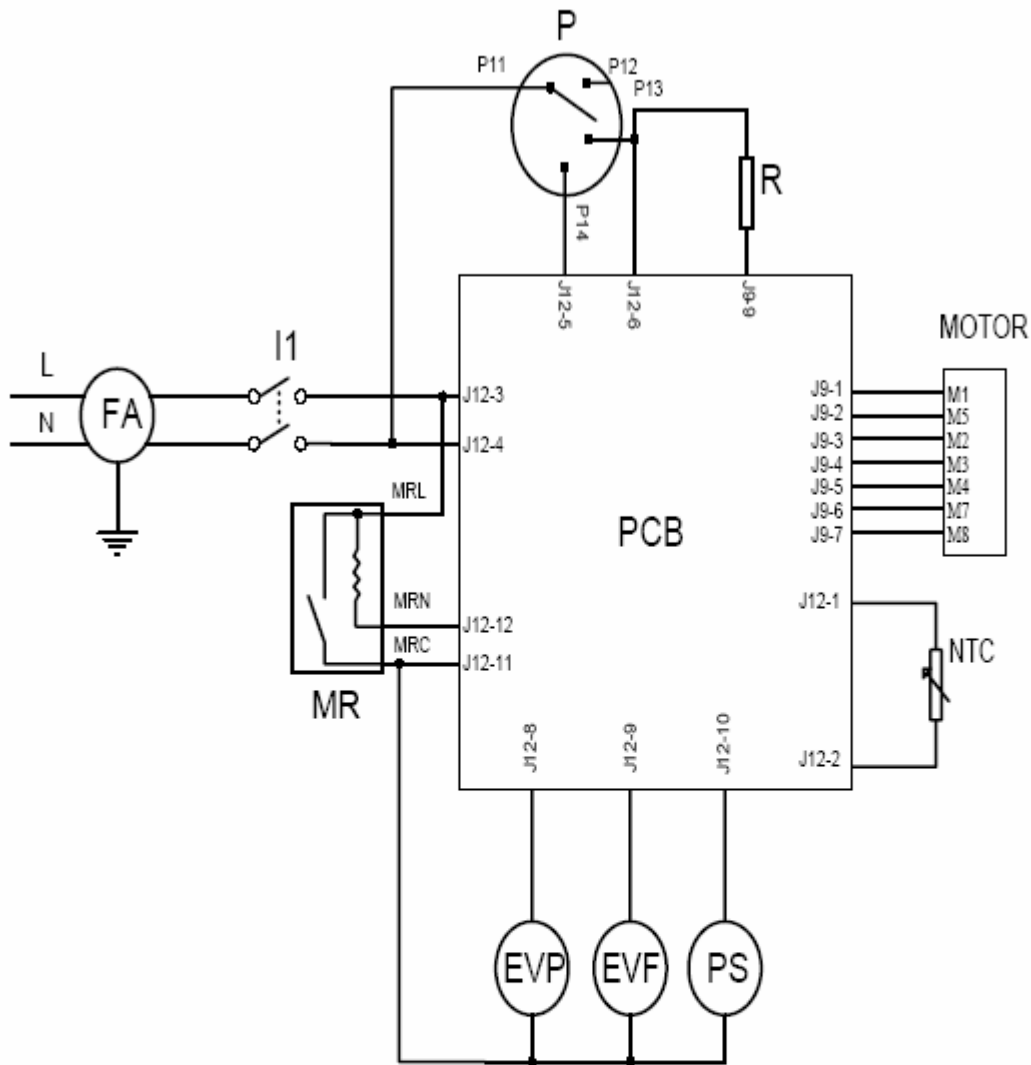

Motor-Motor
 PCB-Printed circuit board
 MR-Door lock
 R-Heating element
 PS-Drainage pump
 EVF,EVP-Water valve
 I1-on/off

P-Pressure switch
 FA-Interference suppresser
 NTC-Temperature sensor

Sincere Forever

Haier Group

Haier Industrial Park, No.1, Road

266101, Qingdao Haier China

<http://www.haier.com>