

Automatic Drum
Washing Machine



HBF1055TVE HBF855TVE

Table of Contents

Before using

Names of Parts-----	inside front cover
Matters Needing Attention-----	1-3
Installation-----	4-5
Control Panel-----	6
Operational Functions-----	6-7

During using

Program Selection-----	8
Preparation-----	9
Washing Methods-----	10-11
Other Function-----	12

Maintenance

Maintenance -----	13
Trouble Shooting-----	14
Wiring Circuit-----	15
Technical Specification-----	16

Names of Parts

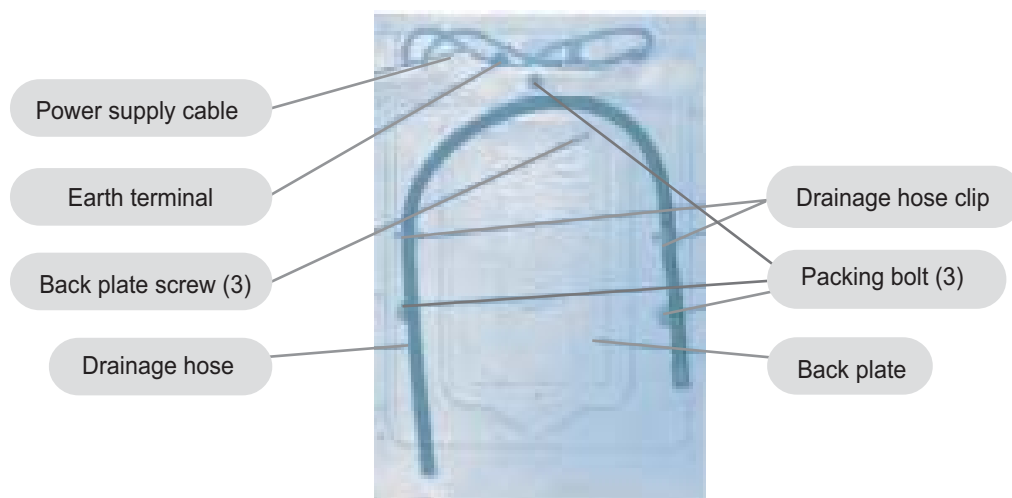
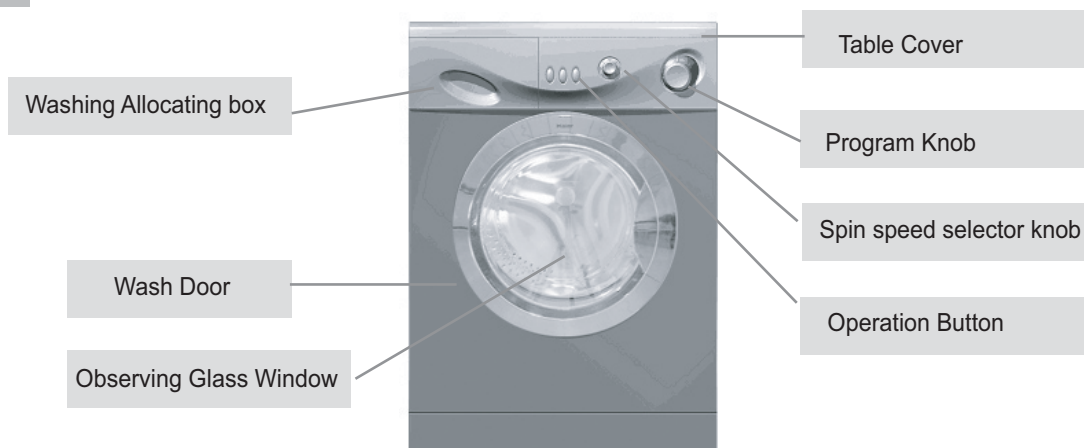

Caution and Warning symbols



For your safety, any instructions in this manual with this "Warning" sign shall be strictly followed.



For your safety and to prevent damages to the washing machine, any instructions in this manual with this "Stop" sign shall be strictly followed.

This diagram may vary slightly with the layout of the washing machine you have just purchased due to technical improvements.

Matters Needing Attention

● Safety

1. A separate earthed socket is required for the power supply. After installation of the washing machine, the power plug should be accessible during the normal wash.

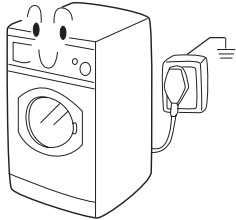

2. Hold the plug and not the electric cable when unplugging the washing machine.

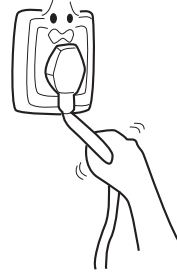

3. Fuses in the power circuit should be rated for 15A. Refer to a washing machine technician or a Haier designated service point for power cable replacement.

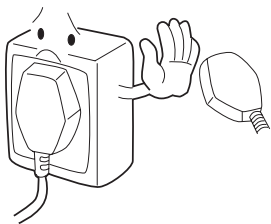

4. For your safety, dry hands before touching the washing machine and wear appropriate footwear.



5. Do not use flammable detergent or dry cleaning agent; do not use flammable spray in close vicinity to the washing machine; do not remove or insert the plug in the presence of flammable gas.



6. The door of the washing machine will become hot during the water heating process. Avoid contact with the door during the heating process. For safety, keep children away from the washing machine.



7. Do not allow children play with the packing materials after unpacking.

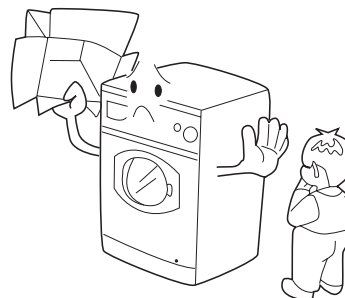

Matters Needing Attention

8. The washing machine must not be used in the open or in area of high moisture as water droplets may form on electrical components, Air dry the appliance if the washing machine components become wet.



9. The washing machine should be placed in a well ventilated area maintaining a space between walls or furniture.

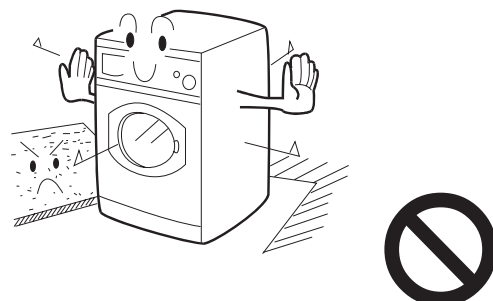

10. Keep away from heat sources and direct sunlight to prevent plastic and rubber components from aging.

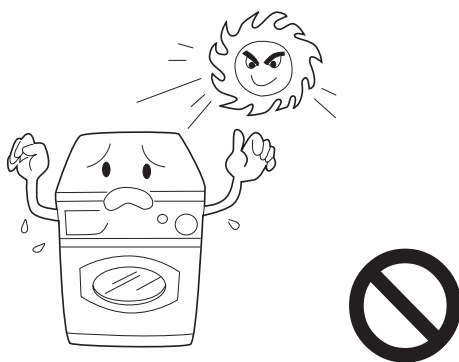

11. During installation, ensure that the electric cable is not trapped by the washing machine and avoid damage to the electric cable. Dear customer, For the machine and your own security, DO NOT REPAIR IT BY YOURSELF! DO NOT USE THE WASHING MACHINE WHICH SOME PARTS ARE LOST!

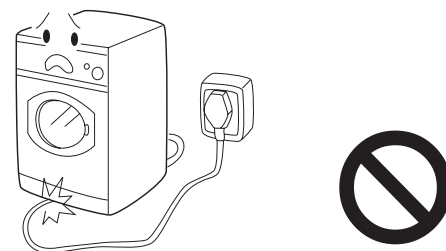

● Use

1. Make sure that the washing machine is securely connected to the water supply, take the necessary precautions or contact the local service center if the connection is poor or there is a water leakage.

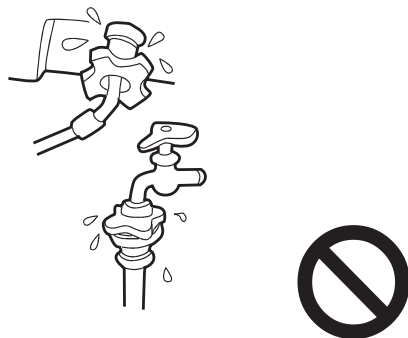

2. After turning the power off, turn the program knob clockwise to set washing program.

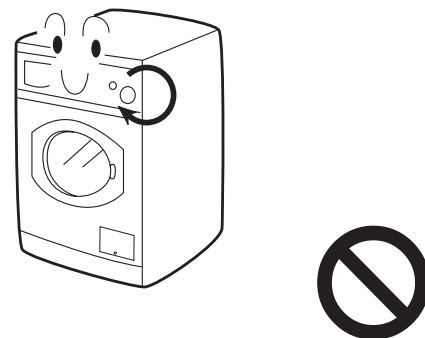

Matters Needing Attention

3. Never place heavy objects ,a heating appliance or a water container on the top panel of the washing machine.



4. Do not wash foam rubber or similar sponge materials.

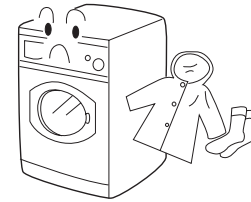

5. Before washing, do up zippers, buttons , laces and repair damaged areas, underwear or small articles should be placed in the laundry bag or a pillowslip.

Do not wash clothes containing wire frames.

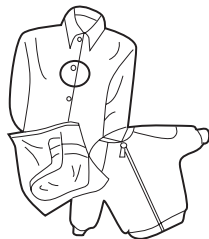

6. Do not open the detergent box during the wash cycle.

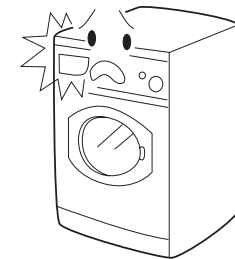

7. The door is fitted with a self-lock device and will not open until 2~3 minutes after the washing machine stops. Do not force the door open. Do not open the door when water level reaches the port hole.



8. After washing, turn off the tap to prevent leakage; unplug the washing machine and wipe clean the lower part of the port hole.

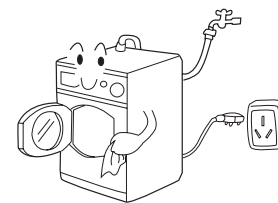

9. Keep the door slightly open when the washing machine is not being used. Never cover the machine with a plastic sheet.



Installation

● As shown in figure1 remove all the packing materials (including the foam base).

Upon opening of the package, water drops may be seen on the plastic bag and the porthole. This is a normal phenomenon resulting from a water test in the factory.

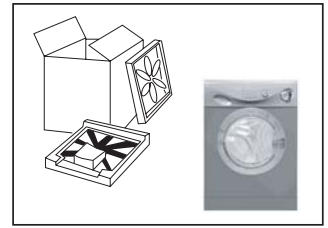

Fig 1

● Remove the packing screws as shown in figure 2.

The packing bolts protect the appliance from shock during transportation. The steps below should be followed before using the appliance,

1. Remove the rear panel of the washing machine;
 2. Remove the three packing bolts from the rear panel of the washing machine, the rubber hose and then the shock absorption channel steel;
 3. Reinstall the back plate;
 4. Fill the holes left by the packing bolts with plastic plugs.
- (Attention: the packing bolts and rubber hose should be kept in a safe place for later use)

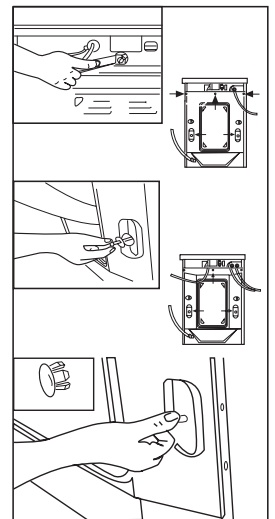

Fig 2

● Adjusting the position of the washing machine. There are adjustable feet under the bottom of the washing machine. Before use, the washing machine should be adjusted, as shown in figure 3, so that it is level.

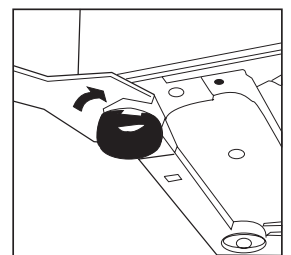

Fig 3

Installation

Connection of water inlet hose and washing machine

- Please connect the straight terminal of the inlet hose to the water tap and make sure to fasten it.
- Please connect the bended terminal of the inlet hose to the solenoid valve and make sure to fasten it.

NOTE:

- Please be sure that the COLD inlet hose is connected with the solenoid valve for cold water (marked with "C").
- Please be sure that the HOT inlet hose is connected with the solenoid valve for hot water (marked with "H").

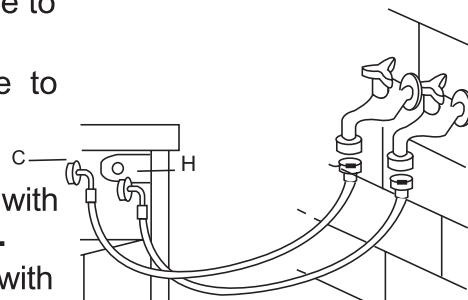

Water drainage hose

- The height of the terminal of the water drainage hose should be between 80cm-100cm, the water drainage hose must be securely placed on the clip on the back of the washing machine.

- Use the water drainage support supplied as an accessory for proper installation of the water drainage hose. fix the water drainage hose support with waterproof string. Do not use an excessively long water drainage hose and contract the authorized technician if the water drainage hose needs to be extended. the water drainage hose should not be extended more than 250cm. (longer extension will result in concurrent water inflow and outflow). The diameter of the extension hose should be the same as the original hose.

caution: water drainage hose must not be immersed in water. the original and extension hoses should be tightly connected.

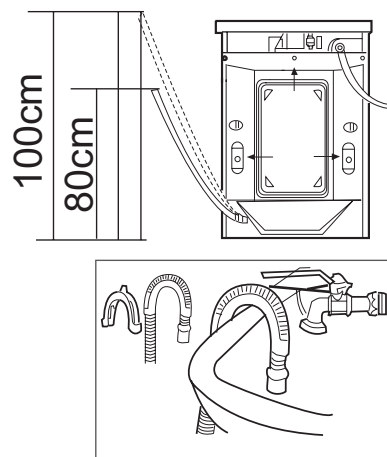

Connection of power supply

Check the following items before connection to the power supply.

- The socket conforms to the maximum power load (The maximum current load of the socket and power supply cable should not be less than 15A).
- Power supply voltage conforms to the required value.
- The power supply socket and the plug of the washing machine compatible, if they are compatible, refer to a washing machine technician or a Haier designated service point for power cable replacement. The washing machine should be connected to an earth before use.
- Supplementary earth cable should not be necessary if the socket is connected to the earth.
- Supplementary earth cable should be installed on the upper back of the washing machine and connected to an earth if the power supply socket has no earth connection.

Control Panel

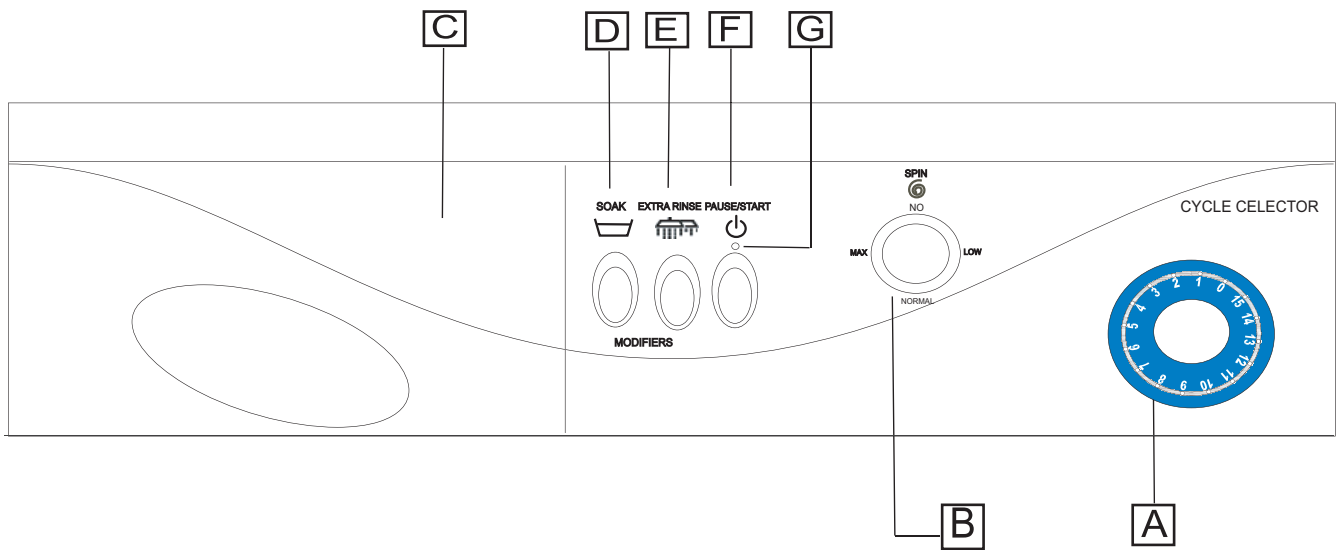

A Washing program

Turn the knob to set the desired wash program .

Caution: Turn the knob at "0", then turn off the power and turn the program knob for setting desired wash program.

The program knob will not rotate with the programmed washing process.

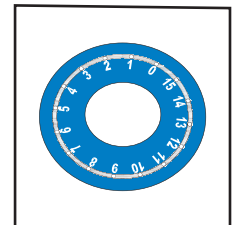

B Spin speed selection knob

By turning this knob, the required spinning speed can be selected.

The maximum speed will vary when a different program is selected.

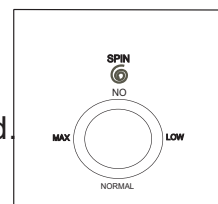

Operational Functions

C Detergent distributor

Program discription are printed on the handle of the detergent distributor,there are three detergent compartments numbered 1,2,3
Box 1: Pre-washing detergent
Box 2: Standard washing - extra-fast washing
Box 3: Softening agent, adjusting agent, perfume

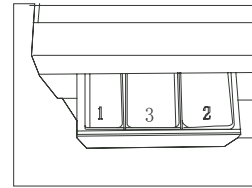

D Soak Button

Press this button,the washing machine will not drain before the final spin-drying cycle.a soaking cycle will be started,and the inner drum will rotate once every 4 minutes(at both directions).If you want to spin the laundry, press this button again ,the program will continue until it ends.



E Extra Rinse Button

If press this button,an addtional rinse operation will be activated before the softening cycle is reached.



F Pause/Start Button

When the electric cable of the washing maching is plugged and a program is selected, after the washing spinning speed function is set,lightly press this button,the operation will start. During a wash cycle,press this button lightly,the operation will pause.Press it again to resume operation.

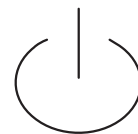

G Door light

The light will illuminate when the door is locked.





Program Selection

Program Setting		Laundry	Water Temperature	Detergent			
				Comp.1 prewash detergent	Comp.2 detergent	Comp. 3 softener.	
Cotton	1	Prewash	Very heavy soil	Hot	★	★	○
	2	Heavy	Heavy soil	Hot	★	★	○
	3	Normal	Soiled cotton	Warm	X	★	○
	4	Light	Non-fade and medium soiled cotton	Warm	X	★	○
	5	Delicate	Fading and medium soiled cotton	Cold	X	★	○
Synthetic	6	Normal	Non-fade heavily soiled chemical fiber	Warm	X	★	○
	7	Light	Non-fade and medium soiled chemical fiber	Cold	X	★	○
	8	Delicate	Fading and medium soiled chemical fiber	Cold	X	★	○
Wool	9	Normal	Non-fade heavily soiled woolen fabrics	Cold	X	★	○
	10	Delicate	Fading and medium soiled woolen fabrics	Cold	X	★	○
Silk	11	Normal	Non-fade heavily soiled silk fabrics	Cold	X	★	○
	12	Delicate	Fading and medium soiled silk fabrics	Cold	X	★	○
	13	Quick	Medium-soiled lanudry	Cold	X	★	○
	14	Rinse		Cold	X	X	○
	15	Spin		*	X	X	X
0	End	Turn the program knob at "0" position and turn off the power. The wash program ends and the washing machine stops operation.					

NOTE: "★" means softener liquid detergent can be added when necessary.
 "○" means detergent can be added when necessary.
 "X" means no detergent can be added.

Preparation

1. Power supply

Plug in the power supply
120V~/60Hz.

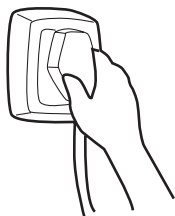

2. Water supply

Turn on the tap ensure that the water is clear.

Caution: Before starting the washing machine turn on the water faucet to ensure that the water faucet and the water inlet hose are connected correctly and do not leak.

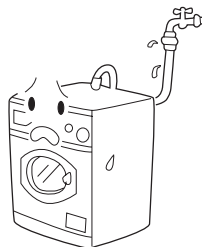

4. Detergent selection

Only special low foam detergent should be used in automatic drum washing machine, for blended or wool fabrics special detergent should be used. Dry cleaning solvent should not be used such as trichloroethylene or alike (caution: load the required amount of detergent only).

3. Laundry treatment

● sort out clothes according to type and extent of dirt. There are three types of clothes: cotton, synthetic and woolen (silk) fabrics.

● separate white clothes from colored. If whites and coloreds are combined for one load, make sure the coloreds are colorfast.

-Remove all objects from pockets that may cause damage to the machine, such as keys and coins.



-Clothing with frayed edges or yarns should be put in a wash bag or special bag before washing.

-Repair damaged clothing, loose buttons or damaged zips and hooks before washing.

-Bed sheets and tableware should be loosely loaded and not folded.

● This washing machine is for household use and designed for mechanically washable clothes. When washing, separate unwashable clothes with reference to clothes labels.

Washing Methods

1. Laundry loading

Evenly load the laundry in the washing machine and then tightly close the door of the washing machine

Note: 1) When first using the washing machine, let it run unloaded for one program to prevent the laundry from being tainted by oil or dirty water from the washing machine. 2) Do not overload the washing machine.



Reference loading

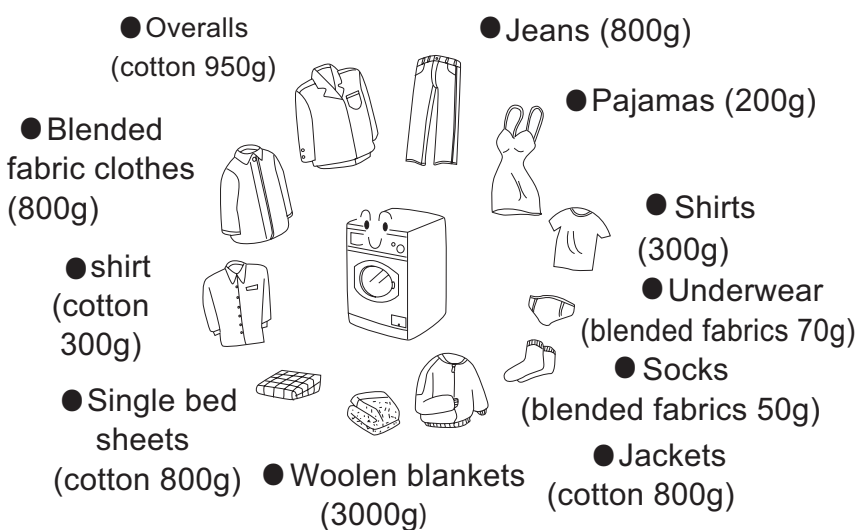

2. Use of detergent

Pull out the detergent drawer, put required detergent, softening agent and bleaching agent into the corresponding boxes. Push back the drawer gently.

- Caution: 1) Do not add liquid detergent into box 1 and 2
2) For pre-washing program, detergent should be added to both box 1 and 2; for other programs, do not add detergent to box 1
3) Do not overuse softening agent as this may damage artificial fabrics.

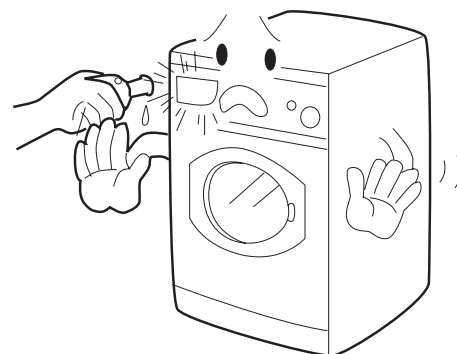

3. Washing program setting

Set the wash program correctly in accordance with the laundry load. The methods for setting wash programs are indicated on the handle of the distributor on the washing machine. Turn the program knob to the desired program.

Caution: If you want to choose another program, first turn the program knob at "0", then turn off the power and turn the program knob for setting desired program.

Washing Methods

4. Selecting the function button

Select function buttons as required (refer to the directions printed on the control panel) , otherwise keep all the button released.

5. Washing

Press the PAUSE/START button and the washing machine will automatically commence the programmed washing process.

Caution: The program knob will not rotate with the programmed washing process.

6. End

Wait 2-3 minutes after the washing process is finished , press the power button again to cut off the power supply Open the door to take out the laundry Turn off the tap and unplug the washing machine.

Caution: When the washing program finishes, the door lock light will glitter before the door can be opened.

Additional information

Energy and water saving during wash process

1. Collect clothes for one full wash load.
2. Do not overload the washing machine.
3. Prewash heavily soiled clothes.
4. Reduce the amount of detergent or choose fast or minimal washing programs for lightly soiled clothes dirty.
5. Choose a proper spin speed.
6. Do not use more detergent than required.
7. Softening agent makes clothes feel softer and easier to iron.

Other Functions

1. Power-off memory function:

This machine has a power-off memory function. In case of abrupt power failure or the power must be cut off during a program cycle, the present settings will be saved, and operation will resume when the power is switched on again.

2. Trouble messages: judge the malfunctions from door lock light

Error 1: The door lock light does not illuminate.

Cause: Door is not properly shut.

Correction: Shut the door properly.

Error 2: The door lock light glitters 2 times and stops 4 seconds repeatedly.

Cause: Drainage error, water not emptied within 4 minutes.

Correction: Clean the filter and check the drain hose for blockage. If error still exists, please contact the maintenance personnel.

Error 3: The door lock light glitters 5 times and stops 4 seconds repeatedly.

Cause: Water level not met in 8 minutes.

Correction: Make sure that tap is turned on, and water pressure is normal. If problem still exists, please contact the maintenance personnel.

Error 4: The door lock light glitters 6 times and stops 4 seconds repeatedly.

Cause: Timing control silicon damage.

Correction: Contact the maintenance personnel.

Error 5: The door lock light glitters 7 times and stops 4 seconds repeatedly.

Cause: Motor overheat protection or damage.

Correction: Contact the maintenance personnel.

Error 6: The door lock light glitters 8 times and stops 4 seconds repeatedly.

Cause: Water exceeds protective level.

Correction: Contact the maintenance personnel.

Maintenance

1. Turn of the water and electricity supply after every wash. Open the door to prevent the formation of moisture and odors. If the washing machine is left idle for a long period, drain any remaining water in the machine and replace the drainage hose.

2. Unplug the machine during cleaning and maintenance. Use a soft cloth dampened with soapy liquid to clean the machine case and rubber components. Do not use corrosive or abrasive chemicals or solvents.

3. Cleaning the Filter(once a month)
 Press the lower edge of the filter compartment cover to open;(Fig1-2)
 Remove the filter by turning counterclockwise; (Fig3)
 Flash clean with running water;
 Filter replacement is the reverse of removal.
 Caution:Attention shall be paid to ensure that the filter is replaced correctly to avoid possible leakage.

4. To prevent blockages to the water supply or the ingress of contaminants, clean the water inlet and inlet water filter regularly.

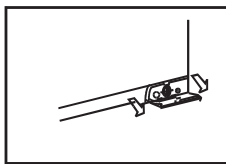

Fig1

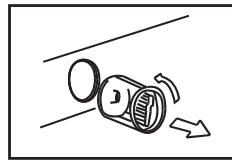

Fig2

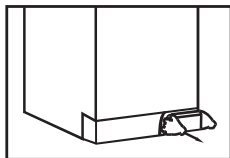
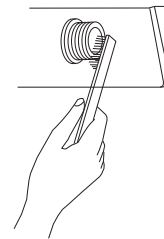
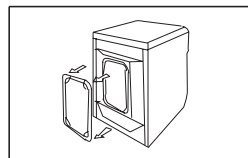

Fig3



6. If the washing machine is left idle for a long period turn off the water and electricity supply and open the door slightly to prevent the formation of moisture and odors.

5. If the machine is to be moved a distance location, replace the vibration mounting locks which were removed during installation as shown below.



Remove the back cover.

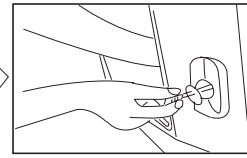

Replace the rubber plugs.

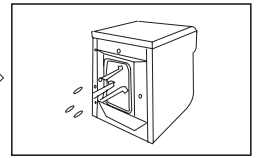

Insert the bolts.

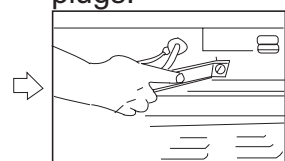

Tighten the bolts with a spanner.

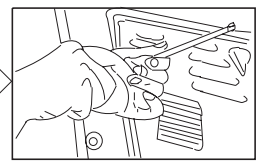

Replace the back cover.

Trouble shooting

The following circumstances do not constitute problems. Do not contact the maintenance service until the problem has been confirmed.

Problem	Possible Cause
The washing machine fails to operate	<ul style="list-style-type: none"> ● Poor connection to power supply ● Power failure ● Door is not properly closed ● Machine has not been switched on
Washing machine does not fill with water	<ul style="list-style-type: none"> ● Water is not turned on ● Water pressure is less than 0.05MPa ● The inlet hose is kinked ● Water supply failure ● The program knob is not properly set ● The door is not properly closed
The water supply and drainage do not stop	<ul style="list-style-type: none"> ● Check that the height of the water hose is below 80cm
Drainage failure	<ul style="list-style-type: none"> ● Drainage hose is blocked ● Drainage hose end is over 100cm above the floor level
Strong vibration during spin	<ul style="list-style-type: none"> ● Some packing fixing bolts removed ● Washing machine on a uneven surface
Operation stops before completion of the wash cycle	<ul style="list-style-type: none"> ● Water or electricity failure
Excessive foam in the drum	<ul style="list-style-type: none"> ● The detergent is not a low foam type ● Excessive detergent has been used

Technical Specification

Item	Model	HBF1055TVE
Power supply		120V~/60Hz
Maximum working current	(A)	13
Water pressure	(MPa)	$0.05 \leq P \leq 1$
Washing power	(W)	400
Spinning power	(W)	1200
Spinning speed	(r/min)	1000
Washing program		15
Size (HXDXW)	(mm)	850x550x595
Weight	(kg)	76

Wiring Circuit

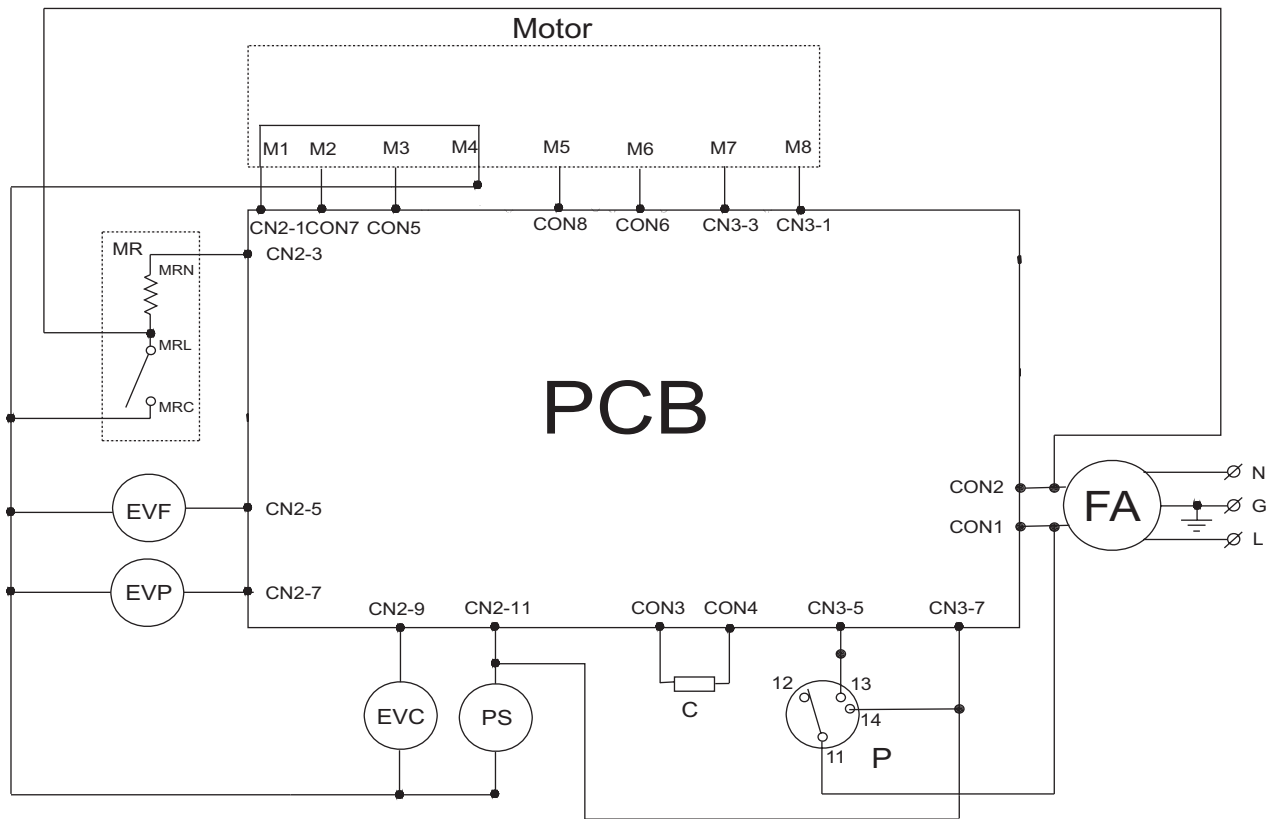

PCB-Printed Circuit Board

EVP,EVF-Cold water Valve

EVC-Hot Water Valve

FA-Interference Suppressor

MR-Door Lock

SW-Power Switch

PS-Drain Pump

P-Pressure Switch