

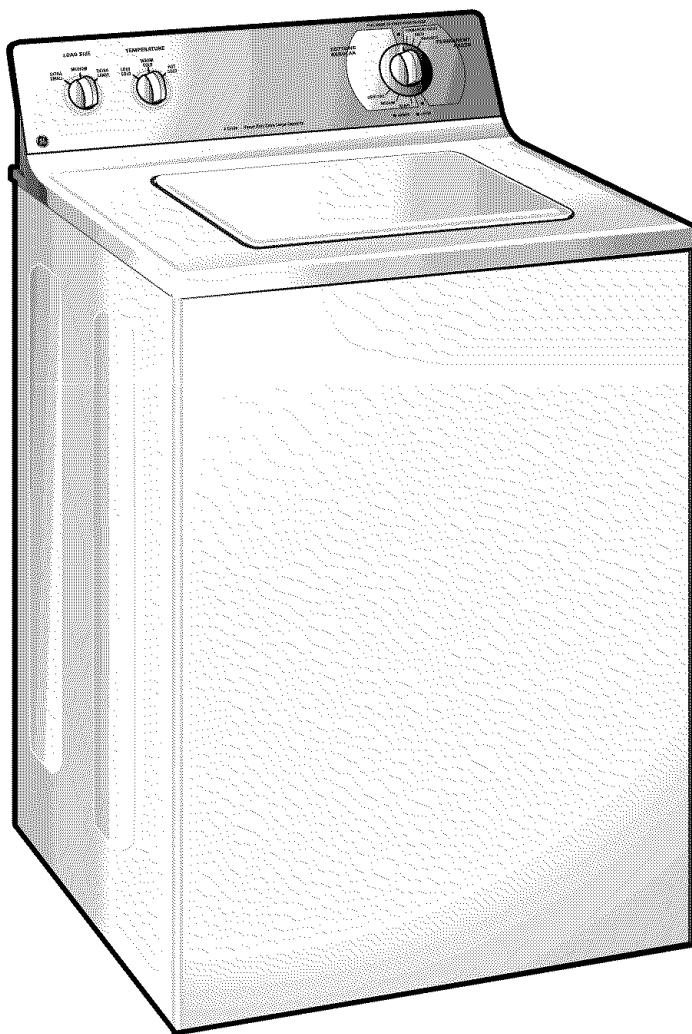

GE Appliances

Washers



Owner's Manual

- | | |
|----------|----------|
| GBSR1070 | GKSR2080 |
| GBXR1070 | GKSR4110 |
| GBXR2060 | GNSR2090 |
| GCXR2080 | GNSR3100 |
| GJSR2080 | GUSR2100 |
| GJXR2080 | GWSR3090 |



Safety Information 3

Operating Instructions

Control Panels and Their Settings 4-11
 Features 12
 Loading and Using the Washer 13, 14

Troubleshooting Tips

Before You Call For Service 15-17

Customer Service

Service Telephone Numbers 18
 Warranty 20

Congratulations! You Are Now Part of the GE Family.

Welcome to the GE family. We're proud of our quality products and we are committed to providing dependable service. You'll see it in this easy-to-use Owner's Manual and you'll hear it in the friendly voices of our customer service department.

Best of all, you'll experience these values each time you use your washer. That's important, because your new washer will be part of your family for many years. And we hope you will be part of ours for a long time to come.

We thank you for buying GE. We appreciate your purchase, and hope you will continue to rely on us whenever you need quality appliances for your home.

A Service Partnership.



IMPORTANT!

Staple sales slip or cancelled check here.

Proof of the original purchase date is needed to obtain service under the warranty.

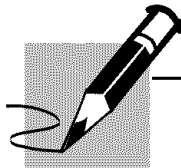

FOR YOUR RECORDS

Write the model and serial numbers here:

 # _____

You can find them in the upper right corner on the back of your washer.

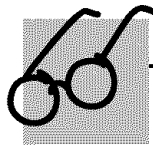

READ THIS MANUAL

Inside you will find many helpful hints on how to use and maintain your washer properly. Just a little preventive care on your part can save you a great deal of time and money over the life of your washer.



IF YOU NEED SERVICE

You'll find many answers to common problems in the *Before You Call For Service* section. If you review our chart of *Troubleshooting Tips* first, you may not need to call for service at all.

If you do need service, you can relax knowing help is only a phone call away. A list of toll-free customer service numbers is included in the back section. Or call 1-800-361-3400.

IMPORTANT SAFETY INFORMATION. READ ALL INSTRUCTIONS BEFORE USING.

⚠ WARNING! For your safety, the information in this manual must be followed to minimize the risk of fire or explosion, electric shock, or to prevent property damage, personal injury, or loss of life.



WATER HEATER SAFETY

Under certain conditions hydrogen gas may be produced in a water heater that has not been used for two weeks or more. Hydrogen gas can be explosive under these circumstances.

If the hot water has not been used for two weeks or more, prevent the possibility of damage or injury by turning on all hot water faucets and allowing them to run for several minutes. Do this before using any electrical appliance which is connected to the hot water system. This simple procedure will allow any built-up hydrogen gas to escape. Since the gas is flammable, do not smoke or use an open flame or appliance during this process.



PROPER INSTALLATION

This washer must be properly installed and located in accordance with the Installation Instructions before it is used. If you did not receive an Installation Instructions sheet, you can receive one by calling, toll-free 1-800-361-3400.

- Install or store where it will not be exposed to temperatures below freezing or exposed to the weather.
- Properly ground washer to conform with all governing codes and ordinances. Follow details in Installation Instructions.



YOUR LAUNDRY AREA

- Keep the area underneath and around your appliances free of combustible materials such as lint, paper, rags, chemicals, etc.
- Close supervision is necessary if this appliance is used by or near children. Do not allow children to play on, with, or inside this or any other appliance.



WHEN USING THE WASHER

- Never reach into washer while it is moving. Wait until the machine has completely stopped before opening the lid.
- The laundry process can reduce the flame retardancy of fabrics. To avoid such a result, carefully follow the garment manufacturer's wash and care instructions.
- Do not mix chlorine bleach with ammonia or acids such as vinegar and/or rust remover. Mixing different chemicals can produce a toxic gas which may cause death.
- To minimize the possibility of electric shock, unplug this appliance from the power supply or disconnect the washer at the household distribution panel by removing the fuse or switching off the circuit breaker before attempting any maintenance or cleaning. **NOTE:** Turning the Cycle Selector knob to an off position does **NOT** disconnect the appliance from the power supply.
- Do not wash or dry articles that have been cleaned in, washed in, soaked in, or spotted with combustible or explosive substances (such as wax, oil, paint, gasoline, degreasers, dry-cleaning solvents, kerosene, etc.) which may ignite or explode. Do not add these substances to the wash water. Do not use or place these substances around your washer or dryer during operation.
- Never attempt to operate this appliance if it is damaged, malfunctioning, partially disassembled, or has missing or broken parts, including a damaged cord or plug.

Use this appliance only for its intended purpose as described in this Owner's Manual.

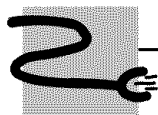

WHEN NOT IN USE

- Turn off water faucets to relieve pressure on hoses and valves and to minimize leakage if a break or rupture should occur. Check the condition of the fill hoses; they may need replacement after 5 years.
- Do not attempt to repair or replace any part of this appliance unless specifically recommended in this Owner's Manual, or in published user-repair instructions that you understand and have the skills to carry out.
- Before discarding a washer, or removing it from service, remove the washer lid to prevent children from hiding inside.
- Do not tamper with controls.



Read and follow this Safety Information carefully.

SAVE THESE INSTRUCTIONS

Find your washer control panel.

You can locate your model number behind the top edge of the control panel.

Model GBSR1070

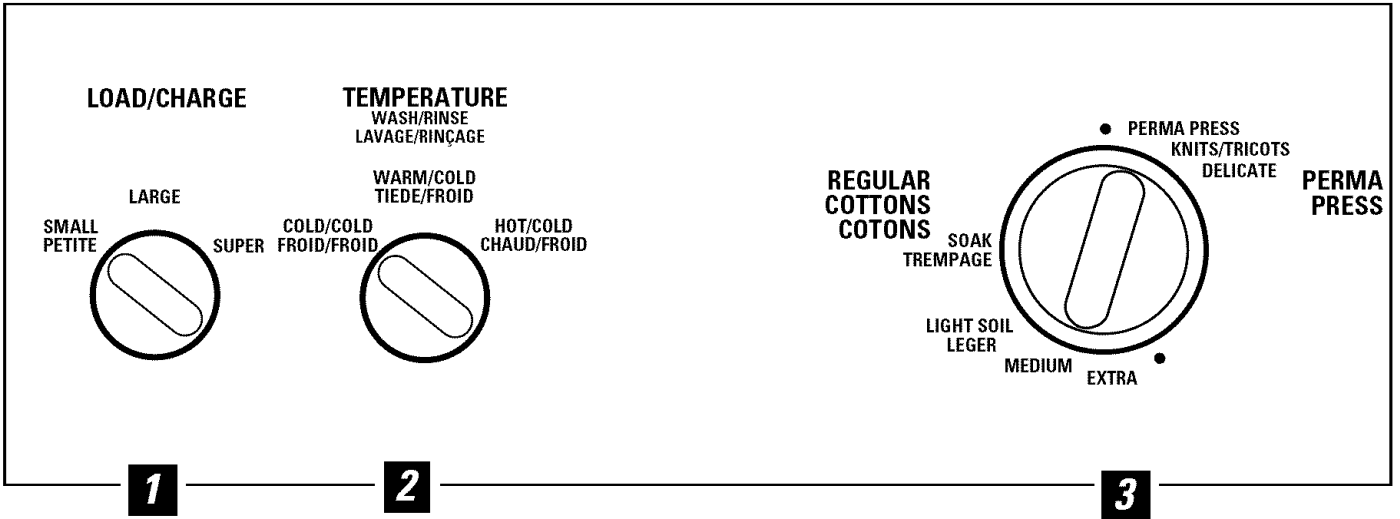

Model GBXR1070

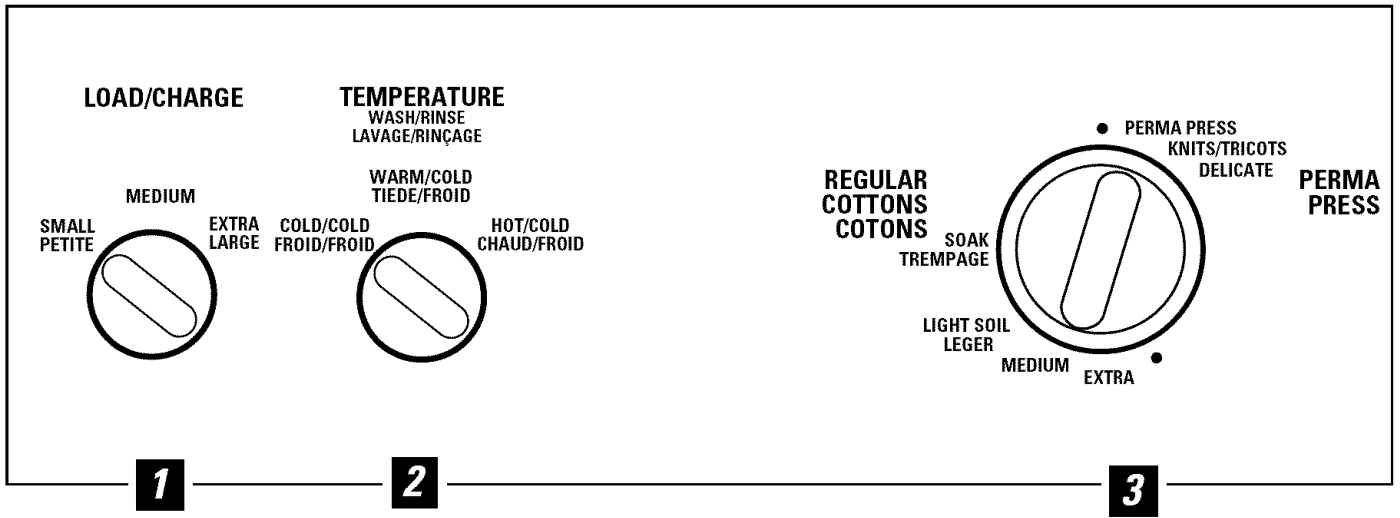

Model GBXR2060

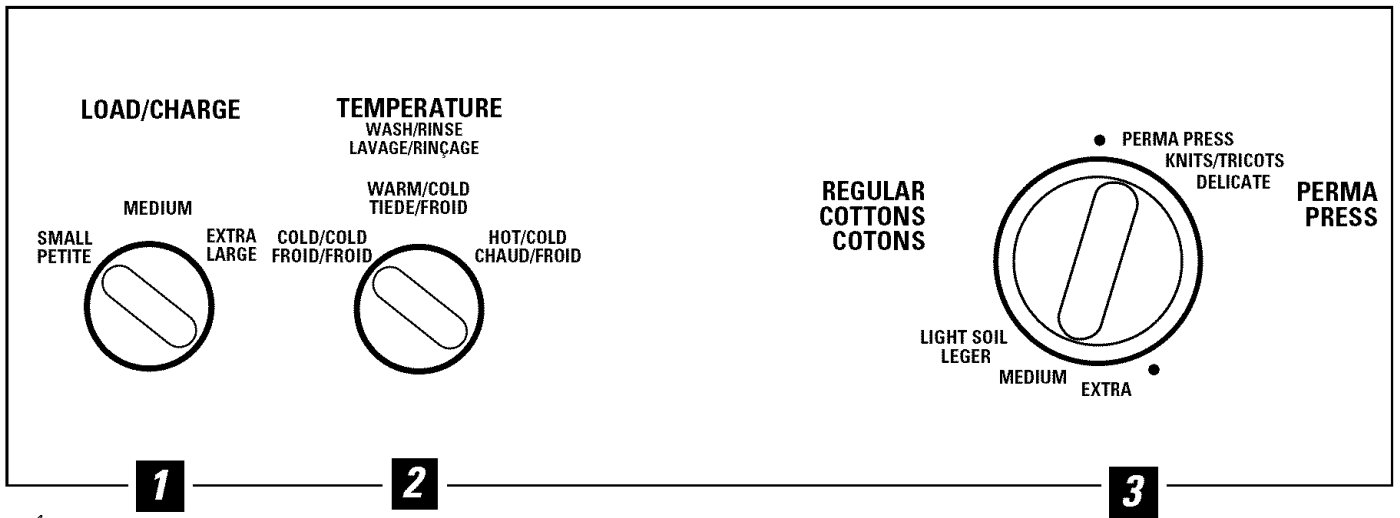

Model GKSR2080

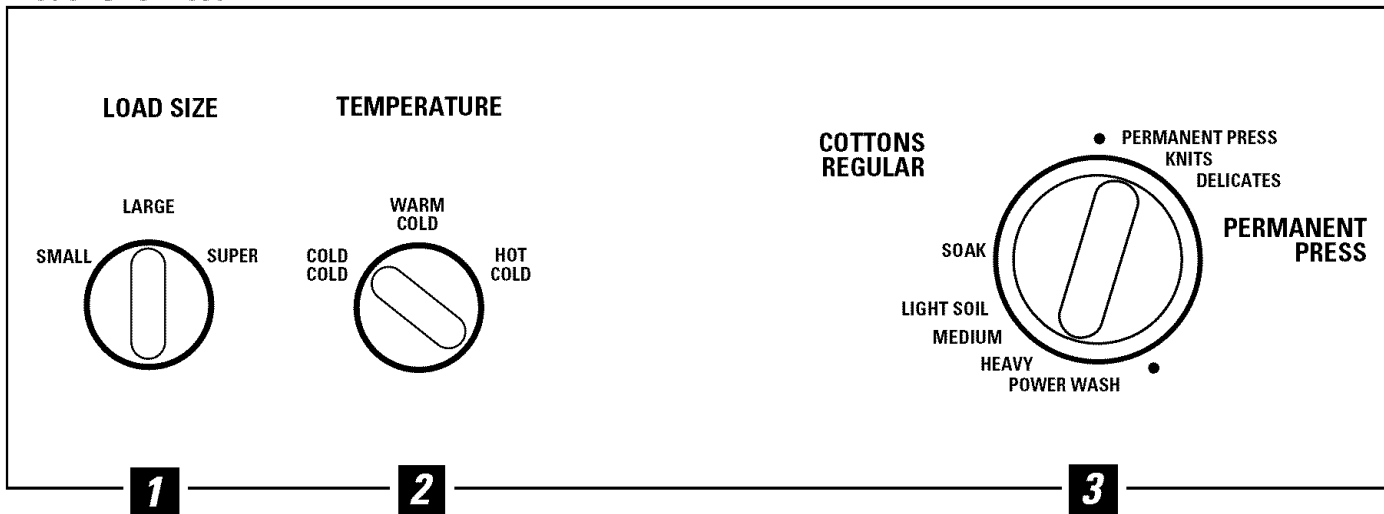

About the control settings.

1 Load Size

The water level should just cover the clothes. Adjust the load size accordingly. Loosely load clothes no higher than the top row of holes in the washer tub.

2 Temperature

Select the water temperature for the wash and rinse cycles. Always follow fabric manufacturer’s care label or instructions when laundering. Follow the water temperature guide on the washer lid.

3 Wash Cycle

The wash cycle controls the length of the washing process. The chart below will help you match the wash cycle setting with your clothing.

REGULAR COTTONS For heavy to lightly soiled cottons, household linens, work and play clothes.

PERMA PRESS For easy care and wrinkle-resistant items.

KNITS Specially designed for normally soiled knits.

DELICATE For lingerie and delicate fabrics with light to normal soil.

SOAK For heavily soiled clothes that need to be soaked before washing. Once the soak and spin cycle is complete reset the control to a wash setting.

POWER WASH For heavily soiled and heavy duty fabrics. This cycle provides longer agitation.

Find your washer control panel.

You can locate your model number behind the top edge of the control panel.

Model GCXR2080

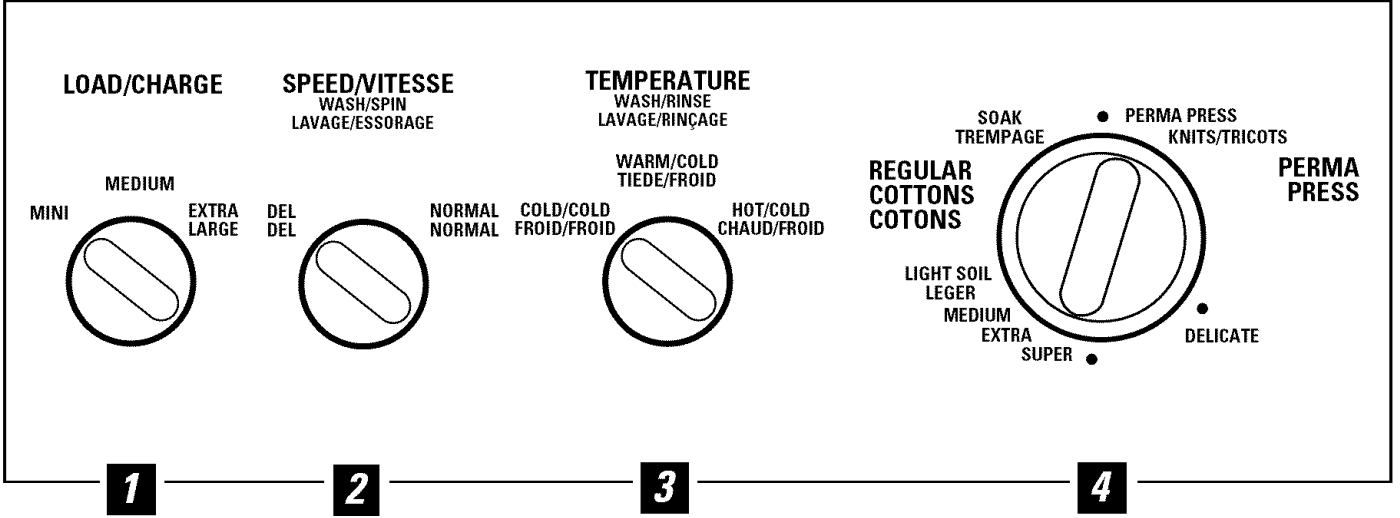

Model GJXR2080

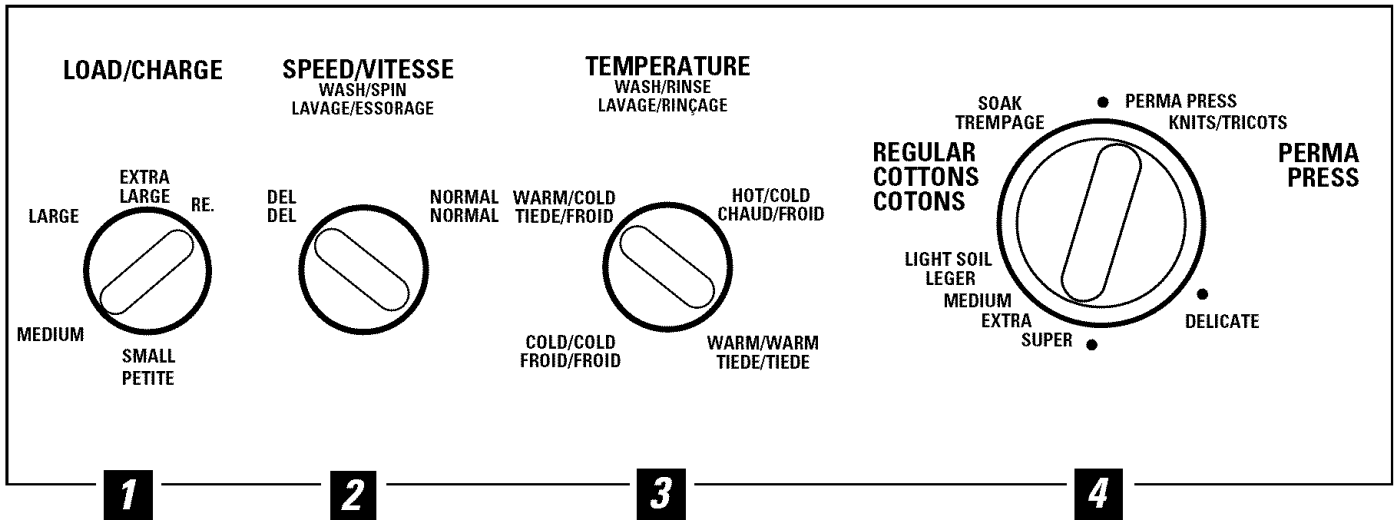

Model GJSR2080

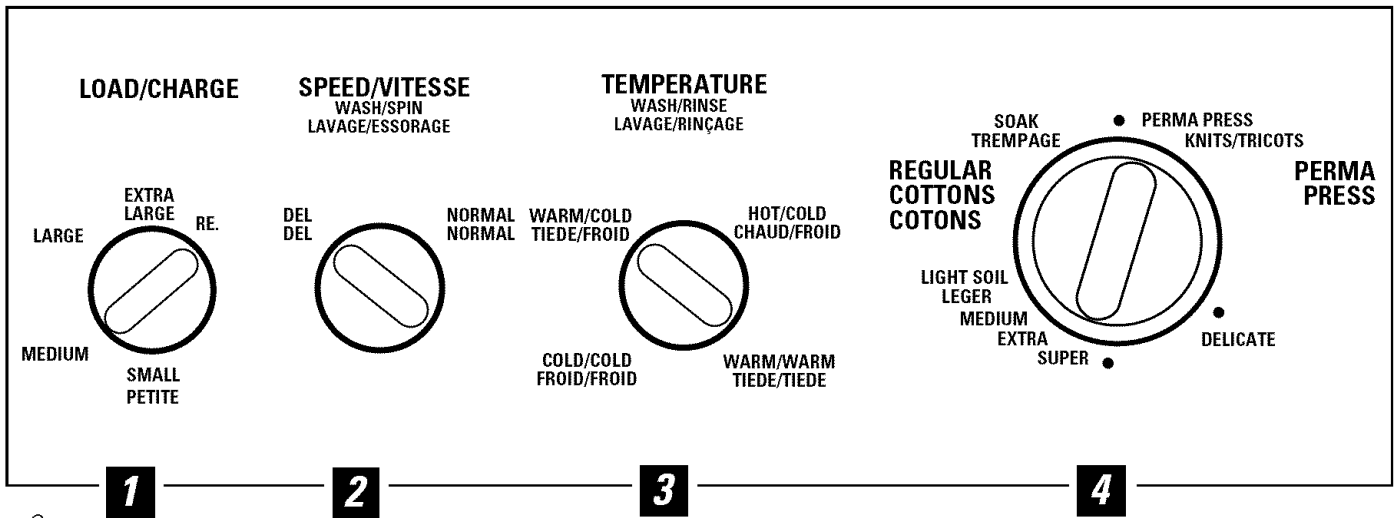

About the control settings.

1 Load Size

The water level should just cover the clothes. Adjust the load size accordingly. Loosely load clothes no higher than the top row of holes in the washer tub.

2 Wash/Spin Speed

The agitator moves clothes around for a cleaner wash; the basket spins later in the cycle to release water from the load. The Wash/Spin Speed dial sets the speed of both the agitator and the basket.

With Normal wash speed, the agitator moves faster. Use for cottons, denims and play clothes. With Gentle wash speed, the agitator moves slower. Use for delicate and knit items.

The Fast spin speed is for durable items. The Slow spin speed is for delicate items like sweaters and lingerie. Clothes will be less dry than when using Fast spin speed.

3 Temperature

Select the water temperature for the wash and rinse cycles. Always follow fabric manufacturer's care label or instructions when laundering. Follow the water temperature guide on the washer lid.

4 Wash Cycle

The wash cycle controls the length of the washing process. The chart below will help you match the wash cycle setting with your clothing.

REGULAR COTTONS For heavy to lightly soiled cottons, household linens, work and play clothes.

PERMA PRESS For easy care and wrinkle-resistant items.

KNITS Specially designed for normally soiled knits.

DELICATE For lingerie and delicate fabrics with light to normal soil.

SOAK For heavily soiled clothes that need to be soaked before washing. Once the soak and spin cycle is complete reset the control to a wash setting.

Find your washer control panel.

You can locate your model number behind the top edge of the control panel.

Model GNSR2090

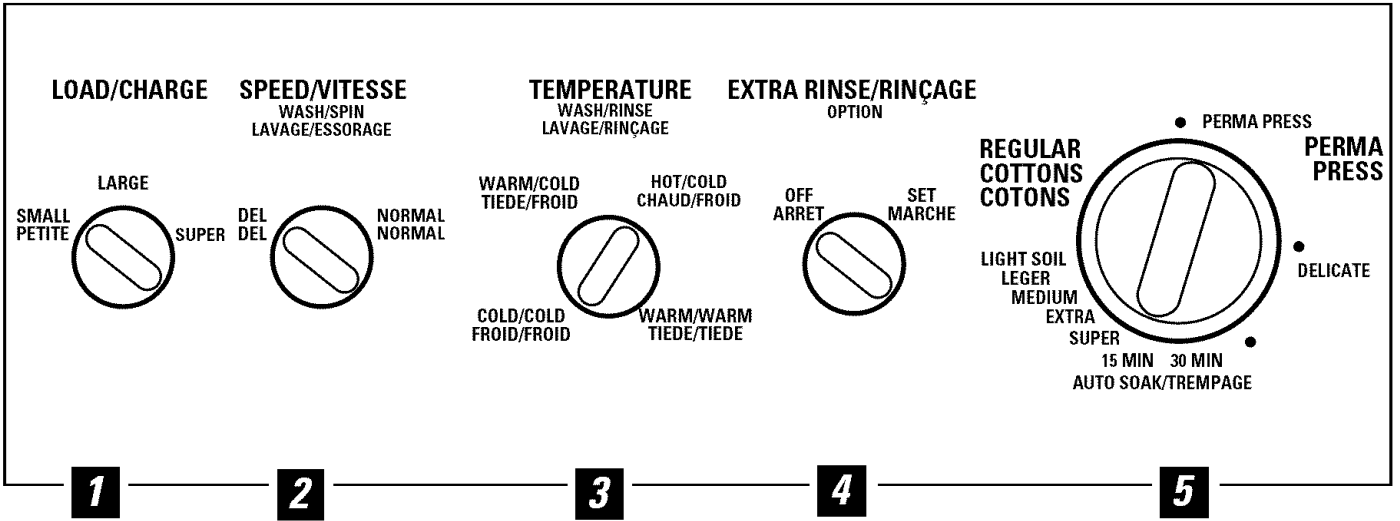

Model GNSR3100

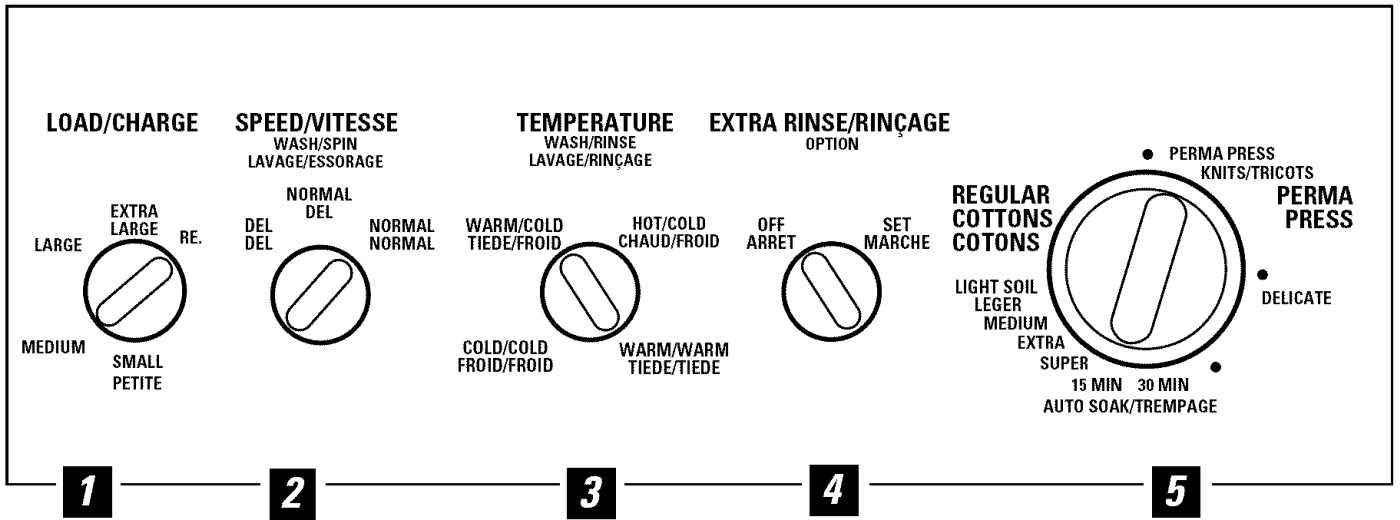

Model GWSR3090

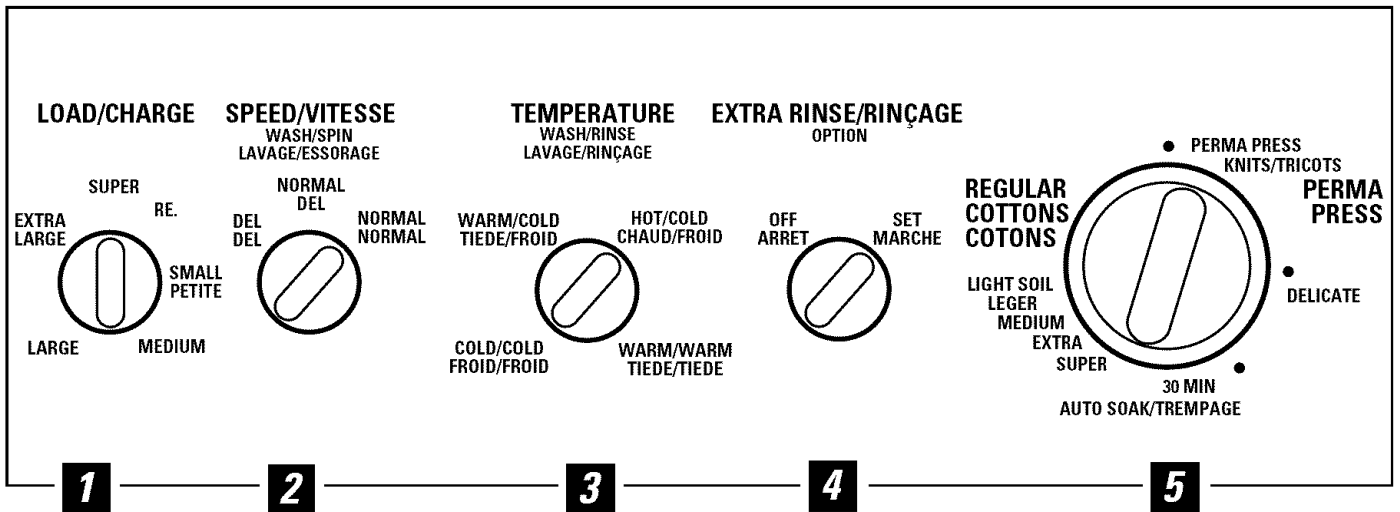

About the control settings.

1 Load Size

The water level should just cover the clothes. Adjust the load size accordingly. Loosely load clothes no higher than the top row of holes in the washer tub.

2 Wash/Spin Speed

The agitator moves clothes around for a cleaner wash; the basket spins later in the cycle to release water from the load. The Wash/Spin Speed dial sets the speed of both the agitator and the basket.

With Normal wash speed, the agitator moves faster. Use for cottons, denims and play clothes. With Gentle wash speed, the agitator moves slower. Use for delicate and knit items.

The Fast spin speed is for durable items. The Slow spin speed is for delicate items like sweaters and lingerie. Clothes will be less dry than when using Fast spin speed.

3 Temperature

Select the water temperature for the wash and rinse cycles. Always follow fabric manufacturer's care label or instructions when laundering. Follow the water temperature guide on the washer lid.

5 Wash Cycle

The wash cycle controls the length of the washing process. The chart below will help you match the wash cycle setting with your clothing.

REGULAR COTTONS For heavy to lightly soiled cottons, household linens, work and play clothes.

PERMA PRESS For easy care and wrinkle-resistant items.

KNITS Specially designed for normally soiled knits.

DELICATE For lingerie and delicate fabrics with light to normal soil.

AUTO SOAK For heavily soiled clothes. Begin with a brief agitation, soaks for a specified period of time, then moves through the rest of the cycle automatically.

About the optional setting.

4 Extra Rinse

When you use extra detergent or bleach to clean heavily soiled clothes, you may want to use the Extra Rinse option. This option provides a second deep cold rinse in the **COTTONS** cycle. Turn the Extra Rinse knob to **SET**.

The washer will pause for a few minutes before the Extra Rinse option begins.

Find your washer control panel.

You can locate your model number behind the top edge of the control panel.

Model GKSR4110

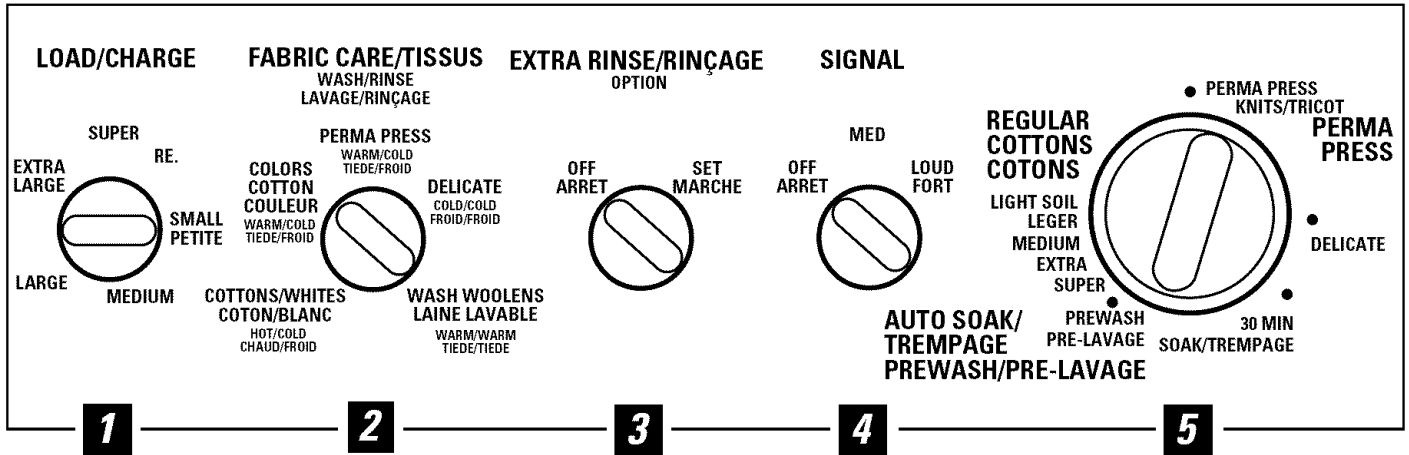

About the control settings.

1 Load Size

The water level should just cover the clothes. Adjust the load size accordingly. Loosely load clothes no higher than the top row of holes in the washer tub.

2 Fabric Care

Always follow fabric manufacturer's care label or instructions when laundering. Follow the water temperature guide on the washer lid.

5 Wash Cycle

The wash cycle controls the length of the washing process. The chart below will help you match the wash cycle setting with your clothing.

| | |
|------------------------|---|
| REGULAR COTTONS | For heavy to lightly soiled cottons, household linens, work and play clothes. |
| PERMA PRESS | For easy care and wrinkle-resistant items. |
| KNITS | Specially designed for normally soiled knits. |
| DELICATE | For lingerie and delicate fabrics with light to normal soil. |
| PREWASH | For heavily soiled clothes or for clothes with a care label that recommends prewashing before wearing. |
| AUTO SOAK | For heavily soiled clothes. Begin with a brief agitation, soaks for a specified period of time, then moves through the rest of the cycle automatically. |

About the optional settings.

3 Extra Rinse

When you use extra detergent or bleach to clean heavily soiled clothes, you may want to use the Extra Rinse option. This option provides a second deep cold rinse in the **COTTONS** cycle. Turn the Extra Rinse knob to **SET**.

The washer will pause for a few minutes before the Extra Rinse option begins.

4 Signal

If the SIGNAL option is selected, a signal will sound just before the end of the cycle. This reminds you to remove the clothes to avoid excess wrinkling before drying. If you selected **EXTRA RINSE** the signal will sound at the end of the cycle and at the end of the **EXTRA RINSE**.

Find your washer control panel.

You can locate your model number behind the top edge of the control panel.

Model GUSR2100

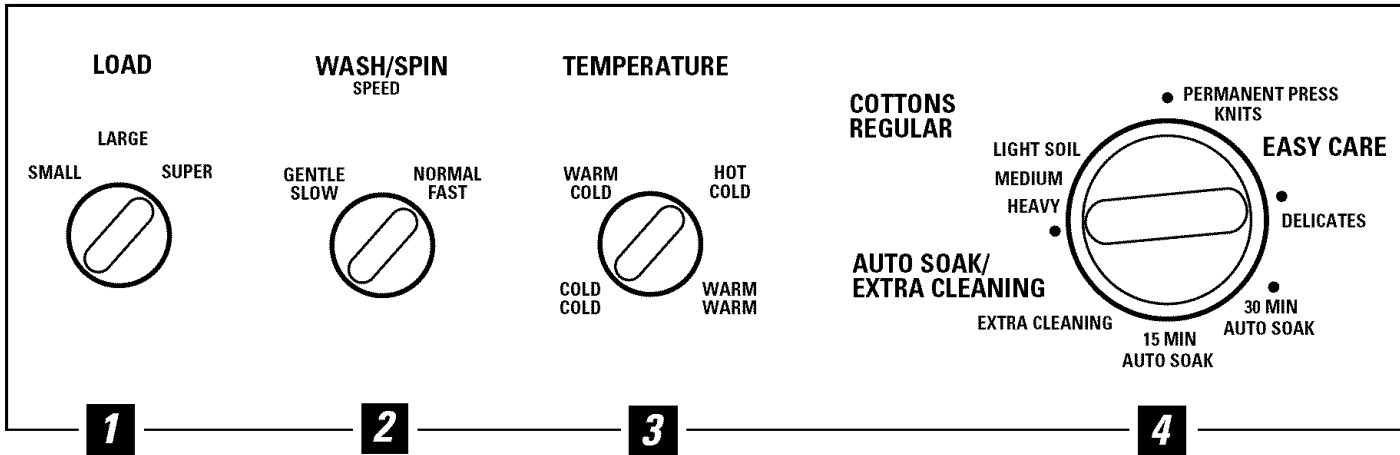

About the control settings.

1 Load Size

The water level should just cover the clothes. Adjust the load size accordingly. Loosely load clothes no higher than the top row of holes in the washer tub.

2 Wash/Spin Speed

The agitator moves clothes around for a cleaner wash; the basket spins later in the cycle to release water from the load. The Wash/Spin Speed dial sets the speed of both the agitator and the basket.

With Normal wash speed, the agitator moves faster. Use for cottons, denims and play clothes. With Gentle wash speed, the agitator moves slower. Use for delicate and knit items.

The Fast spin speed is for durable items. The Slow spin speed is for delicate items like sweaters and lingerie. Clothes will be less dry than when using Fast spin speed.

3 Temperature

Select the water temperature for the wash and rinse cycles. Always follow fabric manufacturer's care label or instructions when laundering. Follow the water temperature guide on the washer lid.

4 Wash Cycle

The wash cycle controls the length of the washing process. The chart below will help you match the wash cycle setting with your clothing.

COTTONS REGULAR For heavy to lightly soiled cottons, household linens, work and play clothes.

EASY CARE For easy care and wrinkle-resistant items.

KNITS Specially designed for normally soiled knits.

DELICATES For lingerie and delicate fabrics with light to normal soil.

AUTO SOAK For heavily soiled clothes. Begins with a brief agitation, soaks for a specified period of time, then moves through the rest of the cycle automatically.

EXTRA CLEANING Provides a timed auto soak, extra rinse and extra spin for heavily soiled clothes.

About washer features. *NOTE: Not all features are available on all washer models.*

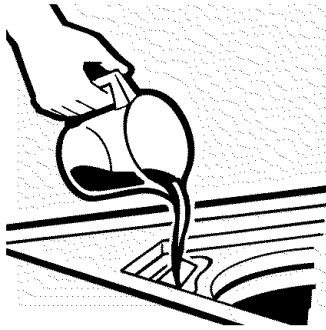

Liquid Bleach Dispenser (on some models)

The dispenser dilutes liquid chlorine bleach before it reaches into your wash load.

- 1 Check clothing care labels for special instructions.
- 2 Measure liquid bleach carefully, following instructions on the bottle.
 - Never pour undiluted liquid chlorine bleach directly onto clothes or into the wash basket.
 - Do not pour powdered bleach into bleach dispenser.
- 3 Before starting the washer, pour measured amount of bleach directly into bleach dispenser. Avoid splashing or over-filling dispenser. If you prefer to use powdered bleach, add it into the wash basket with your detergent.
 - Do not mix chlorine bleach with ammonia or acids such as vinegar and/or rust remover. Mixing can produce a toxic gas which may cause death.

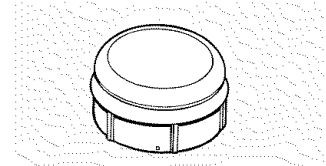

The Agitator Cap or Fabric Softener Dispenser (depending on model)

The **agitator cap** fits into the top of the agitator. If it accidentally comes off, simply put it back on.

- 3 Add water to dispenser until it reaches the maximum fill line.

The **fabric softener dispenser** automatically releases liquid fabric softener at the proper time during the cycle.

Do not stop the washer during the first spin. This will cause the dispenser to empty too soon.

To use, follow these steps:

- 1 Make sure dispenser is securely attached to agitator.
- 2 Use only liquid fabric softener. Pour into dispenser, using amount recommended on package.

Never pour fabric softener directly on clothes. It may stain them.

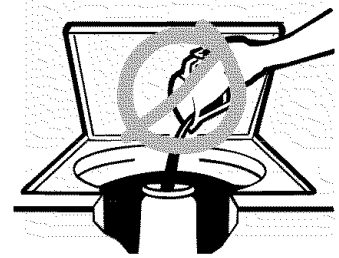

Do not pour anything into the agitator if the agitator cap or dispenser is removed.

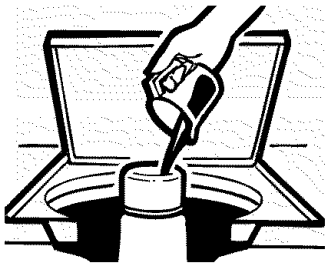

Cleaning the Fabric Softener Dispenser (on some models)

- 1 Remove the dispenser from the top of the agitator.
- 2 Separate the dispenser cup from the cover by grasping the top and pushing down on the inside of the cup with your fingers. Dispenser cup will pop free from the cover.
- 3 To clean the dispenser, soak both the dispenser cup and the dispenser cover in the following solution:
 - 1 US gallon (3.8 liters) warm water
 - 1/4 cup (60 ml) heavy duty liquid detergent
 - 1 cup (240 ml) bleach

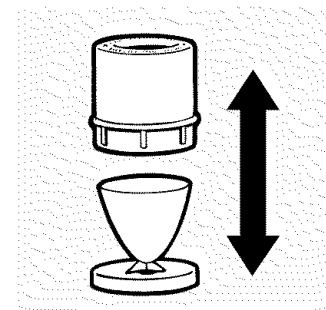

Separate for cleaning.

- 4 If necessary, loosen build-up with a clean, soft cloth after soaking. Do not use a stiff brush; you may roughen the surface of the dispenser.
- 5 Rinse and reassemble dispenser. Place dispenser back on the agitator.

Loading and using the washer. *Always follow fabric manufacturer's care label when laundering.*



Sorting Wash Loads

| Colors | Soil | Fabric | Lint |
|---------------|-------------|----------------|-----------------|
| Whites | Heavy | Delicates | Lint Producers |
| Lights | Normal | Easy Care | Lint Collectors |
| Darks | Light | Sturdy Cottons | |

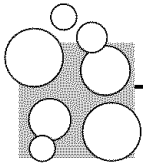

Proper Use of Detergent

Add detergent and start the washer before adding clothes so that the detergent can work effectively. Follow the detergent package directions. Using too little or too much detergent is a common cause of laundry problems.

You can use less detergent if you have soft water, a smaller load, or a lightly soiled load.

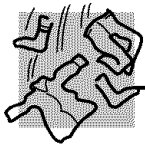

Loading the Washer

Load dry items loosely, no higher than the top row of holes in the washer tub. When loading wet items make sure you set the load/water level high enough to allow the items to move freely. Water level should just cover the clothes. To add items after washer has started, push in Cycle Dial and submerge additional items next to the agitator. Close the lid and pull Cycle Dial out to restart.

- *Do not wrap large items like sheets around the agitator.*
- *Do not wash fabrics containing flammable materials (waxes, cleaning fluids, etc.).*
- *Agitation will not start with the lid up.*

Loading and using the washer. Always follow fabric manufacturer's care label when laundering.



Care and Cleaning of the Washer

Wash Basket: Leave the lid open after washing to allow moisture to evaporate. If you want to clean the basket use a clean soft cloth dampened with liquid detergent, then rinse. (Do not use harsh or gritty cleaners.)

Fill Hoses: Hoses connecting washer to faucet should be replaced every 5 years.

Lint Filter: The lint filter is located under the agitator. It is self-cleaning and requires no maintenance.

Exterior: Immediately wipe off any spills. Wipe with damp cloth. Try not to hit surface with sharp objects.

Moving and Storage: Ask the service technician to remove water from drain pump and hoses. Do not store the washer where it will be exposed to the weather. For information on how to keep the tub stationary when moving the washer write to: Manager, Consumer Relations, Camco Inc., 1 Factory Lane, Suite 310, Moncton, N.B. E1C 9M3.

Long Vacations: Be sure water supply is shut off at faucets. Drain all water from hoses if weather will be below freezing.

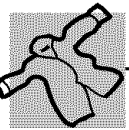

Fabric Care Labels

Below are fabric care label "symbols" that affect the clothing you will be laundering.

WASH LABELS

| | | | | | | | | | | | | | |
|---------------------------|--------------------------|--------|--|---------------------------------------|--|---------------------|--|----------------------|--|-------------|--|--------------|--------------------------|
| <i>Machine wash cycle</i> | | Normal | | Permanent Press/ wrinkle resistant | | Gentle/ delicate | | Hand wash | | Do not wash | | Do not wring | |
| | <i>Water temperature</i> | | | | | | | | | | | | |
| | | | | Hot (50°C/120°F) | | | | Warm (40°C/105°F) | | | | | Cold/cool (30°C/85°F) |

DRY LABELS

| | | | | | | | | | | | | | | |
|-----------------------------|---------------------|-----|--|--------------------------|--|---------------------------------------|--|---------------------|--|-------------------|--|--|--|--------------|
| <i>Tumble dry</i> | | Dry | | Normal | | Permanent Press/ wrinkle resistant | | Gentle/ delicate | | Do not tumble dry | | Do not dry (used with do not wash) | | |
| | <i>Heat setting</i> | | | | | | | | | | | | | |
| | | | | High | | | | Medium | | | | Low | | No heat/air |
| <i>Special instructions</i> | | | | | | | | | | | | | | |
| | | | | Line dry/ hang to dry | | | | Drip dry | | | | Dry flat | | In the shade |

BLEACH LABELS

| | | | | | | |
|-----------------------|--------------------------------------|-----------------------------|--|---|--|---------------|
| <i>Bleach symbols</i> | | Any bleach (when needed) | | Only non-chlorine bleach (when needed) | | Do not bleach |
| | <i>Additional symbols</i> | | | | | |
| | [Empty space for additional symbols] | | | | | |

Before you call for service...



Troubleshooting Tips
 Save time and money! Review the charts on the following pages first and you may not need to call for service.

| Problem | Possible Causes | What To Do |
|-----------------------------|---|--|
| Washer won't operate | Washer is unplugged | • Make sure cord is plugged securely into a working outlet. |
| | Water supply is turned off | • Turn both hot and cold faucets fully on. |
| | Controls are not set properly | • Check controls and make sure Cycle knob is pulled out to ON position. |
| | Lid is open | • Close lid and pull Cycle knob out to ON position. |
| | Circuit breaker/fuse is tripped/blown | • Check house circuit breakers/fuses. Replace fuses or reset breaker. Washer should have separate outlet. |
| Water temperature | Control is not set properly | • Check water temperature control and adjust. |
| | Water supply is turned off or improperly connected | • Turn both hot and cold faucets fully on and make sure hoses are connected to correct faucets. |
| | Water valve screens are stopped up | • Turn off the water source and remove the water connection hoses from the upper back of the washer. Use a brush or toothpick to clean the screens in the machine. Reconnect the hoses and turn the water back on. |
| | House water heater is not set properly | • Make sure house water heater is delivering water at 120°F.-140°F. (48°C.-60°C.). |
| Water won't drain | Drain hose is kinked or improperly connected | • Straighten drain hose and make sure washer is not sitting on it. • Top of drain outlet should be less than 8 ft. (2.5 m) above floor. |
| Water leaks | Fill hoses or drain hose is improperly connected | • Make sure hose connections are tight at faucets and make sure end of drain hose is correctly inserted in and secured to drain facility. |
| | Household drain may be clogged | • Check household plumbing. You may need to call a plumber. |
| | Constant water pressure to the fill hoses at the water source | • Tighten hoses at the faucets and turn the water off after each use. • Check condition of the fill hoses; they may need replacement after 5 years. |

Before you call for service...

| Problem | Possible Causes | What To Do |
|--|---|---|
| Lint or residue on clothes | Incorrect sorting | <ul style="list-style-type: none"> • Separate lint producers from lint collectors. |
| | Washing too long | <ul style="list-style-type: none"> • Wash small loads for a shorter time than larger loads. |
| | Detergent not dissolving | <ul style="list-style-type: none"> • Add detergent as wash basket fills with water, before you load clothes. • Try a liquid detergent. • Use warmer water temperature. |
| | Overloading | <ul style="list-style-type: none"> • Load clothes no higher than the top row of holes in the washer tub. • Make sure load size selector matches clothes load size. |
| Colored spots | Incorrect use of fabric softener | <ul style="list-style-type: none"> • Check fabric softener package for instructions and follow directions for using dispenser. • Pretreat stain and rewash. |
| | Dye transfer | <ul style="list-style-type: none"> • Sort whites or lightly colored items from dark colors. |
| Wrinkling | Improper sorting | <ul style="list-style-type: none"> • Avoid mixing heavy items (like work clothes) with light items (like blouses). • Try a fabric softener. |
| | Overloading or incorrect water level | <ul style="list-style-type: none"> • Load your washer so clothes have enough room to move freely. |
| | Incorrect wash and dry cycles | <ul style="list-style-type: none"> • Match Cycle selection to the type of fabric you are washing (especially for easy care loads). |
| | Repeated washing in water that is too hot | <ul style="list-style-type: none"> • Wash in warm or cold water with plenty of detergent. |
| Too many suds | Type of detergent | <ul style="list-style-type: none"> • Switch to a lower sudsing detergent brand and follow instructions on package. |
| | Very soft water | <ul style="list-style-type: none"> • Try less detergent. |
| Snags, holes, tears, rips or excessive wear | Pins, snaps, hooks, sharp buttons, belt buckles, zippers, and sharp objects left in pockets | <ul style="list-style-type: none"> • Fasten snaps, hooks, buttons, and zippers. • Remove loose items like pins, objects in pockets and sharp buttons. • Turn knits (which snag easily) inside out. |
| | Undiluted chlorine bleach | <ul style="list-style-type: none"> • Check bleach package instructions for proper amount. • Never add undiluted bleach to wash or allow clothes to come in contact with undiluted bleach. |
| | Chemicals like hair bleach or dye, permanent wave solution | <ul style="list-style-type: none"> • Rinse items that may have chemicals on them before washing. |

| Problem | Possible Causes | What To Do |
|-----------------------------------|---|--|
| Pilling | Result of normal wear on poly-cotton blends and fuzzy fabrics | <ul style="list-style-type: none"> While this is not caused by the washer, you can slow the pilling process by washing garments inside out. |
| Grayed or yellowed clothes | Not enough detergent | <ul style="list-style-type: none"> Use more detergent (especially with larger loads). |
| | Hard water | <ul style="list-style-type: none"> Use a water conditioner like Calgon brand or install a water softener. |
| | Water is not hot enough | <ul style="list-style-type: none"> Make sure water heater is delivering water at 120°F.-140°F. (48°C.-60°C.). |
| | Washer is overloaded | <ul style="list-style-type: none"> Select load size to match clothes load. |
| | Detergent is not dissolving | <ul style="list-style-type: none"> Add detergent as wash basket fills with water before you load clothes. |
| | Dye transfer | <ul style="list-style-type: none"> Sort clothes by color. If fabric label states <i>wash separately</i>, unstable dyes may be indicated. |
| Washer is noisy | Washer is uneven | <ul style="list-style-type: none"> Make sure washer is level and firm to the floor. |
| | Washer load is unbalanced | <ul style="list-style-type: none"> Push the Cycle knob in to stop the washer, open the lid and redistribute the load evenly. Close the lid and restart. |
| Washer pauses in cycle | The washer normally pauses between washing steps | |
| Clothes too wet | Incorrect cycle selected | <ul style="list-style-type: none"> Make sure the cycle selected matches the load you are washing. |

Service Telephone Numbers.

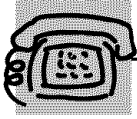

Questions ?

If you have any questions about your appliance, write to:
 Manager, Consumer Relations, Camco Inc., 1 Factory Lane, Suite 310, Moncton, N.B., E1C 9M3.

Or call, 1-800-361-3400.



In-Home Repair Service **1-800-361-3400**

Expert repair service is only a phone call away.



Service Contracts **1-800-461-3636**

Purchase a Camco service contract while your warranty is still in effect and you'll receive a substantial discount. Camco will still be there after your warranty expires.

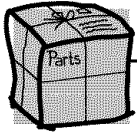

Parts and Accessories

Individuals qualified to service their own appliances can have parts or accessories sent directly to their homes (VISA, MasterCard and Discover cards are accepted).

Instructions contained in this manual cover procedures to be performed by any user. Other servicing generally should be referred to qualified service personnel. Caution must be exercised, since improper servicing may cause unsafe operation.

Please consult your yellow pages for your local Camco number.

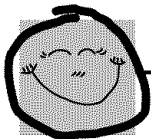

Service Satisfaction

If you are not satisfied with the service you received:

First, contact the people who serviced your appliance.

Next, if you are still not pleased, write all the details—including your phone number—to:
 Director, Consumer Relations, Camco Inc., 1 Factory Lane, Suite 310, Moncton, N.B., E1C 9M3.

| | | | |
|----------------------------|-------------------------------|-----------------------------|-------------------------|
| <i>Safety Instructions</i> | <i>Operating Instructions</i> | <i>Troubleshooting Tips</i> | <i>Customer Service</i> |
|----------------------------|-------------------------------|-----------------------------|-------------------------|

Washer Warranty



All warranty service provided by our Factory Service Centers or an authorized technician. For service, call 1-800-361-3400.

Safety Instructions

For The Period Of: We Will Replace:

One Year
From the date of the original purchase

Any part of the washer which fails due to a defect in materials or workmanship. During this **full one-year warranty**, we will also provide, **free of charge**, all labor and in-home service to replace the defective part.

Five Years
From the date of the original purchase

The suspension rod and spring assembly, if any of these parts should fail due to a defect in materials or workmanship. We will also replace the **washer lid and cover** if they should rust under normal operating conditions. During this **additional four-year limited warranty**, you will be responsible for any labor or in-home service costs.

Ten Years
From the date of the original purchase

The transmission, washer basket and washer tub, if any of these parts should fail due to a defect in materials or workmanship. During this **additional nine-year limited warranty**, you will be responsible for any labor or in-home service costs.

Operating Instructions

What Is Not Covered:

■ Service trips to your home to teach you how to use the product.

■ Improper installation.

Read your Owner's Manual. If you then have any questions about operating the product, please contact your dealer or our Consumer Affairs office at the address below.

If you have an installation problem, contact your dealer or installer. You are responsible for providing adequate electrical, exhausting and other connecting facilities.

Manager, Consumer Relations
Camco Inc.
1 Factory Lane, Suite 310
Moncton, N.B.
E1C 9M3

■ Replacement of house fuses or resetting of circuit breakers.

■ Failure of the product if it is misused, or used for other than the intended purpose or used commercially.

■ Damage to product caused by accident, fire, floods or acts of God.

Troubleshooting Tips

WARRANTOR IS NOT RESPONSIBLE FOR CONSEQUENTIAL DAMAGES.

Warrantor: CAMCO INC.

Customer Service