

# LAVAMAT W 1250 ELECTRONIC

Washing Machine

User information



## Dear Customer,

Please read this instruction book carefully before using the appliance. Please ensure you fully understand the safety instructions on the first pages of this instruction book.

Retain the instruction book for future reference, and pass it on to any future owners.



The warning triangle and / or key words (**Warning!**, **Caution!**, **Important!**) give information that is important for your safety or the function of the appliance is highlighted. It is imperative that this information is observed.



**1.** This symbol guides you step by step through the operation of the appliance.

**2.** ...



This symbol gives you additional information and practical tips on using the appliance.



Tips and information about the economical and environmentally friendly use of the machine are marked with the clover leaf.

In the event of a malfunction, these operating instructions contain information on how to remedy these faults yourself. See the section "What to do if ..."

Printed on recycled paper.

Thinking ecologically means acting ecologically ...

# Contents

<b>Operating Instructions</b> .....	6
<b>Safety</b> .....	6
<b>Disposal</b> .....	8
<b>Environmental tips</b> .....	8
<b>Description of the Appliance</b> .....	9
Front view .....	9
Drawer for Detergent and Conditioners .....	9
Control Panel .....	10
Programme selector .....	10
Programme Option Buttons .....	11
<b>Consumption Values and Programme Times</b> .....	12
<b>Before the First Wash</b> .....	13
<b>Preparing a Wash Load</b> .....	13
Sorting and preparing a wash load .....	13
Types of Washing and Care Symbols .....	14
Detergent and Conditioners .....	15
Which detergent and conditioners? .....	15
Quantities of detergent and conditioners? .....	15
Water softening .....	15
<b>Running a washing cycle</b> .....	16
Brief instructions .....	16
Opening and closing the door .....	17
Loading the washing .....	17
Adding detergent/conditioners .....	18
Setting the washing programme .....	19
Changing Spin Speed/selecting RINSE HOLD .....	19
Starting the Wash Programme .....	20
Programme Progress .....	20
Changing the washing programme .....	20
Washing cycle complete/removing the washing .....	21

<b>Programme Tables</b> .....	22
Washing .....	22
Separate Rinsing .....	23
Separate Spinning .....	23
<b>Maintenance and Cleaning</b> .....	24
Control panel .....	24
Detergent Dispenser Drawer .....	24
Washing Machine Drum .....	25
Main door .....	25
Cleaning the drain pump .....	26
<b>What to do if ...</b> .....	28
Trouble Shooting .....	28
If the washing results are not satisfactory .....	32
Carrying out an emergency emptying .....	33
Additional rinse cycles (RINSE+) .....	34
<b>Child Safety Feature</b> .....	35
<b>Installation and connection instructions</b> .....	36
<b>Installation Safety Precautions</b> .....	36
<b>Installation of the appliance</b> .....	37
Transporting the appliance .....	37
Remove transport packaging .....	37
Installation-Site preparation .....	39
Installation on a Suspended Floor .....	39
Levelling the Appliance .....	40

---

<b>Electrical Connection</b> .....	41
<b>Water connection</b> .....	43
Water pressure .....	43
Inlet Hose Connection .....	44
Water Drainage .....	45
Pump head of greater than 1m .....	46
<b>Technical data</b> .....	47
<b>Dimensions</b> .....	47
<b>Warranty conditions</b> .....	48
<b>Index</b> .....	50
<b>Service &amp; Spare Parts</b> .....	51

# Operating Instructions



## Safety

The safety features of AEG electrical appliances comply with accepted technical standards and the German Appliance Safety Law. However, we also consider it our obligation as a manufacturer to inform you about the following safety information.

### Prior to initial start-up

- Observe the **"Installation and Connection Instructions"** in this instruction book.
- If the appliance is delivered in the winter months and temperatures are below freezing: Store the washing machine at room temperature for a few hours before putting it into operation.

### Intended Use

- The washing machine is only intended for washing normal domestic washing. If the appliance is used for any other purpose or incorrectly operated, the manufacturer accepts no liability for any damages which may result.
- It is dangerous to alter the specifications or attempt to modify this product in any way.
- Only use detergents which are suitable for automatic washing machines, and follow the recommendations of the detergent manufacturer.
- Garments which have been in contact with flammable solvents should not be washed. Also bear this in mind when washing pre-cleaned washing.
- Do not use the washing machine for dry-cleaning.
- Dyes and bleaching agents may only be used if specifically permitted by the manufacturer of these products. We cannot be held liable for any damages.
- This appliance must be connected to the cold water supply only.
- Damage due to frost is not covered by the guarantee. If the washing machine is located in a room in which below freezing temperatures may occur, emergency emptying must be carried out (see "carrying out an emergency emptying").

## Child Safety

- Packaging materials (e.g. films, styrofoam) can be dangerous for children. There is a risk of suffocation! Keep all packaging well away from children.
- This appliance is designed to be operated by adults. Do not allow children to tamper with the controls or play with the appliance.
- Pets and children have been known to climb into washing machines. Please check the drum before use.
- When disposing of the appliance, cut off the mains cable, and destroy the plug. Disable the door lock to prevent young children being trapped inside.

## General Safety

- Repairs to washing machines must only be carried out by qualified personnel. Repairs carried out by inexperienced persons may cause injury or serious malfunctioning. Contact your local AEG Service Force Centre.
- Never operate the washing machine if the mains cable is damaged or the control panel, work top or base area are damaged allowing internal components to be accessible.
- Switch off the appliance and isolate from the mains supply before carrying out any cleaning or maintenance work.
- Do not use the mains cable to remove the plug from the socket. Always pull the plug itself.
- Adapters and extension cables must not be used. **There is a danger of overheating!**
- Do not clean the washing machine with a water jet. There is a danger of electric shock!
- During high temperature wash programmes the glass of the door may become hot. Do not touch!
- Allow the water to cool down before cleaning the drain pump, carrying out emergency emptying or opening the door in an emergency.
- Small animals/pets can chew on power cables and water hoses. This can lead to the risk of electric shock and water damage to the appliance and property. Keep small animals away from the appliance.



## Disposal

### Packaging

Dispose of the packaging material correctly. All packaging materials used are environmentally friendly and can be disposed of without any danger to the environment.

- Plastic parts can be recycled and are identified as follows:
  - >PE< for polyethylene, e.g. the outer covering and the bags in the interior.
  - >PS< for polystyrene, e.g. padding (always CFC-free)
  - >POM< for polyoxymethylene, e.g. plastic clips
- Cardboard packaging is manufactured from recycled paper and should be deposited in the waste paper collection for recycling.

### When disposing of the washing machine!

Cut off the mains cable and destroy the plug. Disable the door catch to prevent young children becoming trapped inside. Use an authorised disposal site.



## Environmental tips

To save water and energy, and to help protect the environment, we recommend that you follow these tips.

- Do not use a pre-wash for normally soiled washing.
- It is more economical to wash full loads.
- When washing small loads, reduce the detergent by half to two thirds.
- Pre-treat stains, and then wash at a lower temperature.
- Use the energy-saving programme when washing light to normally soiled garments.
- In hard water areas, the use of a water softening agent can reduce the amount of detergent necessary. See manufacturers recommendations.



# Description of the Appliance

## Front view

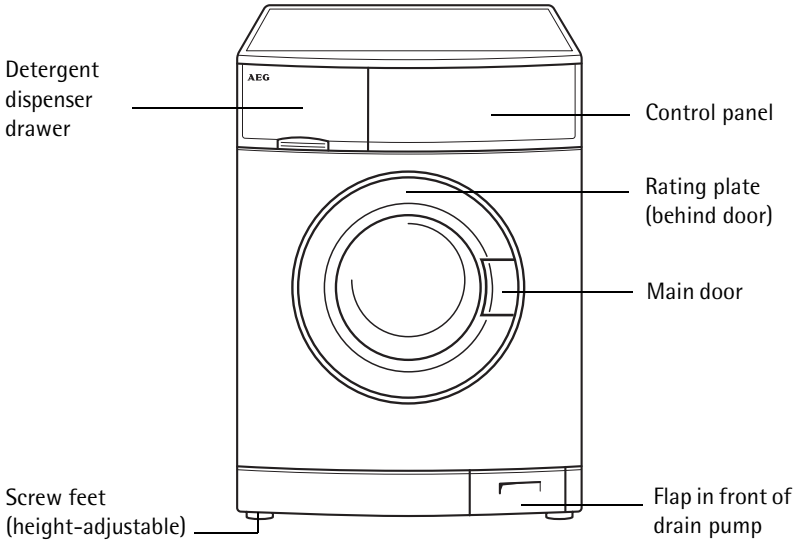

## Drawer for Detergent and Conditioners

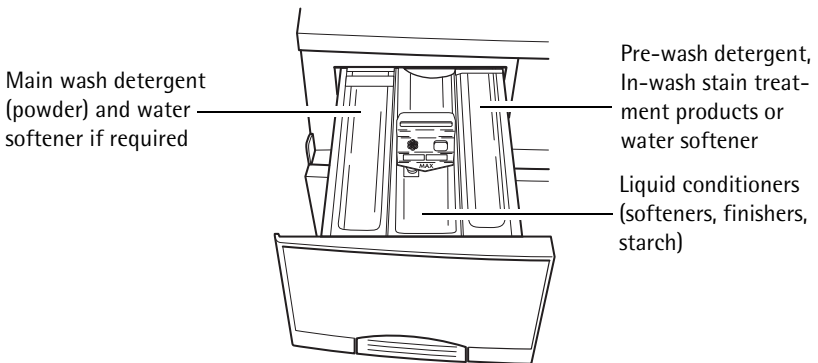

## Control Panel

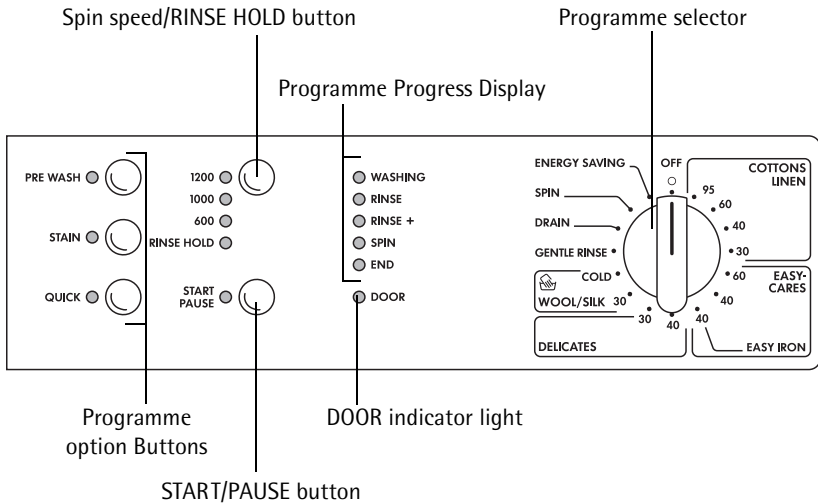

### Programme selector

The programme selector is used to select the wash cycle (for example, water level, drum movement, number of rinses, spin speed) and the water temperature according to the type of washing.

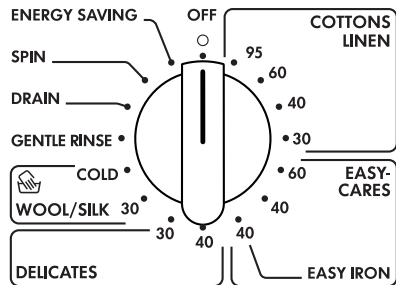

### OFF

- Switches the washing machine off - at all other positions the machine is on.
- To amend programme settings selected by mistake, turn the selector to OFF. This restores the original settings.

### COTTONS/LINEN

Main wash cycle for Cottons/Coloureds (cottons/linens) from 30 °C to 95 °C.

**EASY-CARES**

Main wash cycle for easy-care fabrics (mixed fibres) at 40 °C or 60 °C.

**EASY IRON position:** main wash cycle at 40°C for easy-care fabrics which, after washing with this programme, require only light ironing or no ironing at all.

**DELICATES**

Main wash cycle for Delicates at 30 °C or 40°C.

**WOOL/SILK**  **(Handwash)**

Main wash cycle (cold or 30 °C) for machine-washable or hand-washable woollen items and silk, carrying the symbol  (Handwash).

**GENTLE RINSE**

Separate gentle rinse, for example to rinse hand-washed items (3 rinses, liquid conditioner washed in from  compartment, spin).

**DRAIN**

Draining of the water after one rinse hold (without spinning).



The effect of Rinse Hold is that the washing is left to soak in the last rinse water, without spinning.

**SPIN**

Draining of the water after Rinse Hold and Spin, or separate Spin for hand-washed Cottons/Linen.

**ENERGY SAVING**

Energy and water saving wash at approx. 60 °C for lightly to normally soiled Cottons/Coloureds (cottons/linen) with an extended wash time (cannot be combined with the QUICK option).

**Programme Option Buttons**

The programme option buttons are used to adapt the programme to suit the degree of soiling of the wash. The programme options are not needed for normally soiled washing.

The different functions can be combined together, depending on the programme.

**PRE-WASH**

Warm pre-wash before the main wash, which follows automatically; intermediate spin in the COTTONS/LINEN and EASY CARES programme; no intermediate spin in the DELICATES programme.



## STAIN

For heavily soiled or stained washing. In-wash stain treatment products are washed in at the optimum time as the programme progresses. Can only be selected with wash temperatures of 40 °C and above, as stain treatment products are only effective at higher temperatures.

## QUICK

Shortened wash programme for lightly soiled washing.



With the WOOL/SILK  (Handwash) setting, the programme option buttons cannot be used. (Any buttons that are pressed have no effect.)

# Consumption Values and Programme Times

The following tables give the values for selected programmes under standard conditions. The tables do, however, give a helpful guide for normal household use.

Programme selector/Temperature	Load in kg	Water in litres	Energy in kWh	Time in minutes
COTTONS/LINEN 95	5	56	1.90	130
ENERGY SAVING 60 <sup>1)</sup>	5	49	0.94	125
COTTONS/LINEN 40	5	52	0.55	112
EASY-CARES 40	2.5	56	0.45	76
DELICATES 30	2.5	58	0.35	64
WOOL/SILK  (Handwash) 30	2	52	0.35	52

1) **Note:** Programme setting for testing in accordance with standard EN60 456. Actual consumption will vary from the indicated values depending on water pressure, water hardness, inlet water temperature, room temperature, type and quantity of washing, detergent used, variations in mains voltage and any option functions selected.

## Before the First Wash

-  1. Pull the detergent dispenser drawer out slightly.
2. Pour about 1 litre of water through the detergent dispenser drawer into the washing machine. The next time a programme is started the solution container will be closed and the ECO valve can function correctly.
3. Carry out a washing cycle without any washing laundry (COTTONS 95, using half the usual quantity of washing detergent). This removes any residues from the drum and solution container which may have been left during manufacturing.

## Preparing a Wash Load

### Sorting and preparing a wash load

- Sort washing according to the care symbol and type (see "Washing types and care symbols").
- Empty all pockets.
- Remove metal objects (paper clips, safety pins etc.).
- In order to prevent bunching up of washing and damage to washing, close zippers, button up duvet covers and pillow cases, and tie up loose straps such as from aprons.
- Turn articles with double layered textiles inside out (sleeping bags, anoraks etc.).
- Coloured, knitted fabrics, as well as wool and fabrics with appliqués should be turned inside out.
- Place small and delicate items (e.g. socks, tights and stockings, bras etc.) in a washing net, or pillow case.
- Handle curtains with care. Metal rollers or burred, plastic rollers must be removed or tied into a net or bag. We cannot accept liability for damage.
- Do not wash coloured and white washing together. This could discolour white washing or turn it grey.
- New, coloured washing often contains excessive dye. Wash these separately the first time.
- Mix small and large items of washing. This improves washing efficiency and the washing is more evenly distributed during the spinning cycle.

- Shake out washing before placing into the washing machine.
- Do not place folded washing into the drum.
- Observe tips such as "wash separately" and "wash separately several times".

## Types of Washing and Care Symbols

Care symbols help you to choose the correct wash programme. Washing should be sorted by type, and according to their care symbols. The temperature indicated on the care symbol is the maximum wash temperature.

### Cottons

Cotton and linen items with this care symbol are not sensitive to machine washing or high temperatures. The COTTONS/LINEN programme is suitable for this type of washing.

### Linen

Cotton and linen items with this care symbol are not sensitive to machine washing. The COTTONS/LINEN programme is suitable for this type of washing.

### Easy-Cares

Materials such as fine cotton, wool-blend fabrics, viscose, and synthetics with these care symbols require gentler treatment. The EASY-CARES/EASY IRON programmes are suitable for this type of washing.

### Delicates

Materials such as layered fibres, microfibres, viscose, synthetics, and net curtains with this care symbol require particularly careful treatment. The DELICATES programme is suitable for this type of washing.

### Wool/silk and especially sensitive materials

Woollens, wool blends and silk with these care symbols are particularly sensitive to machine washing. The WOOL/SILK  (Handwash) programme is suitable for this type of washing.

**Important!** Materials with the care symbol  (Not machine-washable!) should not be washed in the washing machine.

## Detergent and Conditioners

### Which detergent and conditioners?

Only use detergents and conditioners that are suitable for use in washing machines. Always follow the manufacturer's instructions.

### Quantities of detergent and conditioners?

The quantity to be used will depend on:

- degree of soiling of the washing
- degree of hardness of the water supply
- load



If the manufacturer does not indicate the amounts to use for smaller loads, for half-loads use a third less than the amount recommended for a full load, and for smaller loads and EASY IRON use half the amount recommended for a full load.

Please follow the detergent and conditioner manufacturers' instructions for use and dosing recommendations.

## Water softening

For medium to high water hardness (hardness class II upwards) a water softening agent can be used. Refer to the manufacturer's instructions. Then always add the appropriate amount of detergent (underdosing) for hardness class I (soft). Your local Water Authority can advise you on the hardness of the water in your area.

### Water hardness details

Hardness class	Water hardness in °dH (German hardness scale)	Water hardness in ppm (Parts Per Million)
I - soft	0 - 7	to 125
II - medium hard	7 - 14	125 - 250
III - hard	14 - 21	250 - 375
IV - very hard	greater than 21	greater than 375

# Running a washing cycle

## Brief instructions

A washing cycle consists of the following steps:

1. Open the door and load the washing.
2. Close the door.
3. Add detergent/conditioner.
4. Set the appropriate washing programme:
  - Set the programme and temperature using the programme selector
  - Set programme options as required.
5. Change the Spin Speed /select RINSE HOLD as necessary.
6. Start the washing programme by pressing the START/PAUSE button.



### After the washing programme has ended:

**Important!** If the washing cycle has ended with a Rinse Hold, select DRAIN or SPIN before opening the door.

7. Open the door and remove the washing.  
The door can be opened after the DOOR light goes off and the END light has come on.
8. To switch off the washing machine: turn the programme selector to OFF.



## Opening and closing the door

-  To open: pull the door by the handle.
-  To close: push the door firmly shut.

When the machine is switched on, the DOOR light and the START/PAUSE light indicate whether the door can be opened





DOOR indicator	START/PAUSE indicator	Can the door be opened?
flashes	flashes	yes, after about 2 minutes
lit	lit	no <sup>1)</sup>
is off	flashes	yes

1) Door is locked due to high water level or high temperature.

-  If the END light flashes 4 times and an acoustic signal is emitted 4 times, it means there was an attempt to start a wash programme without closing the door properly. If this happens, push the door firmly shut and start the wash programme again.

## Loading the washing

-  See "Programme Tables" for maximum loads. For information about the correct preparation of the washing see "Sort and prepare washing".
- 
  1. Sort and prepare the washing according to type.
  2. Open the door: Pull the handle on the door.
  3. Load the washing.
 

**Important!** Do not trap washing when closing the door. The fabrics and the machine could be damaged.
  4. Close the door firmly.

## Adding detergent/conditioners

**i** For instructions concerning detergent and conditioners, see Section "Detergents and conditioners".

- 1.** Open the detergent dispenser drawer: press the flap on the drawer so as to be able to grasp the handle (1), and pull out the drawer (2).

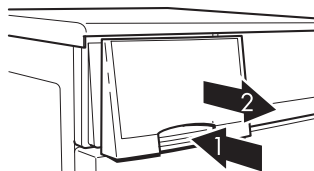

- 2.** Add the detergent/conditioners.

### Compartment for main wash powder detergents

(If you use a water softener and need the right-hand compartment for the pre-wash/stain treatment product, add the water softener to the left-hand compartment with the main wash detergent.)

### Compartment for liquid conditioners (softeners, finishers, starch)

**Important!** Do not fill the compartment past the MAX mark. If required, dilute concentrated fluids up to the MAX mark, dissolve powdered starches.

**Note:** A small amount of water remaining in the liquid conditioner compartment is normal and does not affect rinse results.

### Compartment for Pre-wash detergent or in-wash stain treatment products or for water softener

- 3.** Push the drawer in fully.

**i** **If using liquid detergents/tablets:** Add liquid detergent or tablets using the dosage container provided by the detergent manufacturer. Follow the instructions on the detergent packaging.

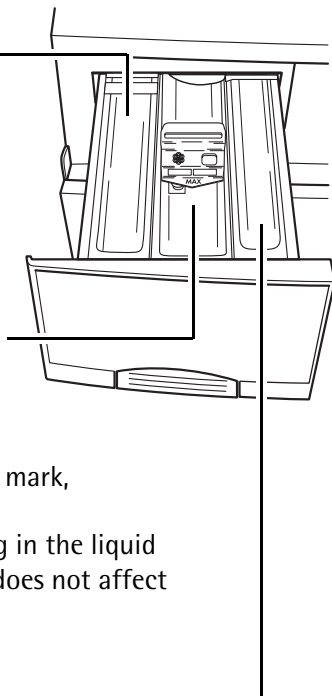

## Setting the washing programme

**i** For the appropriate programme, temperature and possible programme options suitable for any type of washing, see "Programme Tables".

**1.** Select the desired wash programme and temperature with the programme selector.

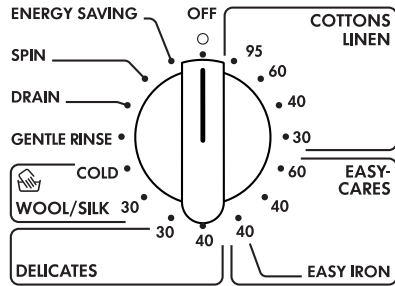

**2.** If required, select the appropriate programme option(s):

The indicator of the selected programme option illuminates.

- To change the selection, press another button.
- To cancel a selection, press the button again.



## Changing Spin Speed/selecting RINSE HOLD

**1.** To change the Spin Speed for the final rinse or select RINSE HOLD:

Keep pressing the Spin Speed/RINSE HOLD button until the indicator light for the desired speed (or RINSE HOLD) comes on.

If RINSE HOLD is selected, the washing is left to soak in the last rinse water, without spinning.

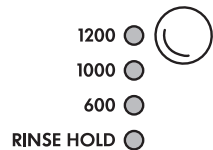

**i** If the Spin Speed is not changed, the final spin is automatically adjusted to suit the washing programme:

- |                         |                             |
|-------------------------|-----------------------------|
| - COTTONS/LINEN         | 1200 revolutions per minute |
| - ENERGY SAVING         | 1200 revolutions per minute |
| - EASY-CARES/EASY IRON  | 1000 revolutions per minute |
| - DELICATES             | 1000 revolutions per minute |
| - WOOL/SILK  (Handwash) | 1000 revolutions per minute |

The speed of intermediate spins depends on the selected programme and cannot be changed.

## Starting the Wash Programme

1. Check that the water tap is open.
2. To start the wash programme, press the START/PAUSE button. The wash programme starts.



- i** If END flashes 4 times and an acoustic signal is emitted 4 times when the START/PAUSE button is pressed, the door is not closed properly. In this case, push the door in firmly, and press START/PAUSE again.

## Programme Progress

### Programme Progress Display

Prior to the start, the programme steps chosen are displayed by the programme progress display. During the wash programme, the current programme step is displayed.

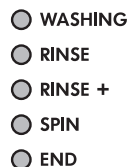

## Changing the washing programme

### Changing or cancelling the programme

1. Press the START/PAUSE button.
2. Turn the programme selector to OFF. The washing programme is cancelled.
3. Set another washing programme, if required. Otherwise, turn the programme selector to DRAIN or SPIN and press the START/PAUSE button. (The water is drained or the washing is spun.)

- i** The washing programme can be temporarily interrupted at any time by pressing the START/PAUSE button. It is then re-started by pressing the button again. A washing programme can only be changed after the programme selector has been turned to OFF.

### Selecting a programme option

The programme options QUICK or STAIN can still be selected after the programme has started.

1. Press the START/PAUSE button.
2. Press the QUICK or STAIN button.
3. Press the START/PAUSE button. The washing programme continues.

### Changing the Spin Speed

The Spin Speed can still be changed or RINSE HOLD set, while the programme is running.

1. Press the START/PAUSE button.
2. Change the spin speed with the Spin Speed/RINSE HOLD button.
3. Press the START/PAUSE button again. The washing programme continues.

### Washing cycle complete/removing the washing

Once a washing programme cycle has come to an end, END illuminates on the Programme Progress Display.







If RINSE HOLD was selected, the indicator lights beside DOOR and END come on.

1. After a Rinse Hold, the water must first be drained:
    - Either turn the programme selector to OFF, then turn to DRAIN and press the START/PAUSE button (the water is drained without spinning),
    - or
    - turn the programme selector to OFF, then turn to SPIN and press the START/PAUSE button (the water is drained and the washing given a spin. The spin speed can also be changed during the spin cycle).When this stage of the programme is completed, the END light comes on.
  2. Open the door.  
The door can be opened after the DOOR light goes off and the END light has come on.
  3. Remove the washing.
  4. Turn the programme selector to OFF.
  5. Close the water tap.
  6. After the washing cycle is completed, pull out the detergent dispenser drawer slightly, to allow it to dry. Leave the door slightly open, to air the inside of the washing machine.
- Important!** If the washing machine is not to be used for a long period: Close the water tap and disconnect the washing machine from the electricity mains.

# Programme Tables

## Washing

The tables do not show all the possible settings, only those most likely to be selected for everyday purposes.

Type of washing, Care symbol	Max. Load (Dry weight) <sup>1)</sup>	Programme selector Temperature [in °C]	Possible programme options
Cottons 	5 kg	COTTONS/LINEN 95	PRE-WASH or STAIN QUICK
Cottons/Coloureds <sup>2)</sup> 	5 kg	ENERGY SAVING	PRE-WASH or STAIN
Coloureds 	5 kg	COTTONS/LINEN 30 to 60	PRE-WASH or STAIN <sup>3)</sup> QUICK
Easy-cares 	2.5 kg	EASY-CARES 40, 60	PRE-WASH or STAIN QUICK
	1 kg	EASY IRON <sup>4)</sup> 40	
Delicates 	2.5 kg (or 15-20m <sup>2</sup> net curtains)	DELICATES 30, 40	PRE-WASH or QUICK
Wool/Silk (Handwash) 	2 kg	 WOOL/SILK COLD, 30	

- 1) A 10 litre bucket holds around 2.5 kg of dry clothes (cotton).
- 2) Programme settings for testing in accordance with or in support of EN 60 456 and IEC 60 456 are described in the chapter "Consumption Values and Programme Times".
- 3) A temperature of at least 40 °C is needed for the STAIN programme, to make stain treatment products effective.
- 4) Creasing can largely be avoided, but only by keeping wash loads under 1 kg, About 1 kg of dry clothes is equivalent to between 5 and 7 easy-care men's shirts.

## Separate Rinsing

Type of washing	Max. load (dry weight)	Programme selector
Cottons/Coloureds	5kg	GENTLE RINSE
Easy-Cares/Delicates <sup>1)</sup>	2.5kg	

1) Reduced spin speed

## Separate Spinning

Type of washing	Max. load (dry weight)	Programme selector
Cottons/Coloureds	5kg	SPIN
Easy-Cares <sup>1)</sup>	2.5kg	
Delicates <sup>1)</sup>	2.5kg	
Wool/Silk (Handwash) <sup>1)</sup>	2kg	

1) Reduced spin speed.

# Maintenance and Cleaning

## Control panel

**Important!** Do not use household furniture polish or abrasive cleaners to clean panel and operating parts.

- ☞ Wipe over the operating panels with a damp cloth. Use warm water.

## Detergent Dispenser Drawer

The detergent dispenser drawer should be cleaned from time to time.

- ☞ 1. Pull the detergent dispenser drawer out as far as it will go.
- 2. Remove the detergent dispenser drawer by pulling sharply.
- 3. Take the conditioner insert out of the middle compartment.
- 4. Clean the conditioner insert under running water.

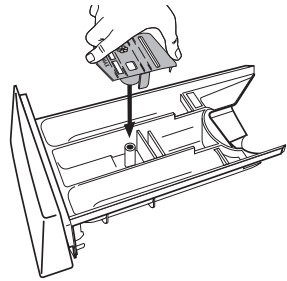

- 5. Clean the separate compartments with warm water. It is best to use a flat brush.

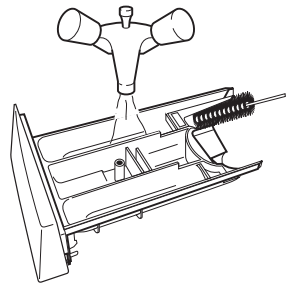

- 6. Push on the conditioner insert as far as it will go so that it is securely in place.



7. Use a brush to clean the entire compartment area of the washing machine, particularly also the nozzles on the top side of the compartment.

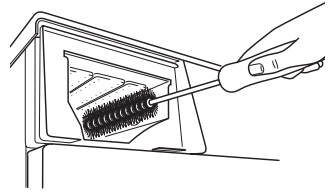

8. Set the detergent dispensing drawer into the guide tracks and push it in.

## Washing Machine Drum

The washing machine drum is made from rust-free stainless steel. Any objects left in the laundry which are likely to rust can stain the drum.

**Important!** Do not clean the stainless steel drum with descaling agents containing acids, scouring agents containing chlorine or iron, or steel wool. Your local AEG Service Force Centre has suitable agents available.

- ☞ Remove any rust stains on the drum using a stainless steel cleaning agent.

### Maintenance Wash

- i With the use of low temperature washes it is possible to get a build up of residues inside the drum.  
 We recommend that a maintenance wash be performed on a regular basis.

#### To run a maintenance wash:

The drum should be empty of laundry.

- ☞ 1. Select the hottest cotton wash programme.
- 2. Use a normal measure of detergent, must be a powder.

## Main door

- ☞ Regularly check to see if there are deposits or foreign objects in the rubber seal behind the door, and remove them.

## Cleaning the drain pump

Paper clips, nails and so on can sometimes get into the washing machine with the washing and remain in the drain pump casing. Fluff and strands of fabric can gather on these items and block the drain pump. Therefore the drain pump should be cleaned at least once a year.



**Warning!** Switch off the washing machine and pull out the mains plug before cleaning the drain pump!

1. First carry out emergency emptying (see section "Carrying out emergency emptying").
2. Place a towel on the floor in front of the cover of the drain pump. Residual water can run out.
3. Unscrew the drain pump cover anti-clockwise and pull it out.

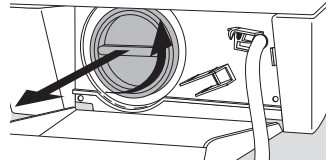

4. Remove any foreign objects, fluff and strands of fabric from the drain pump.

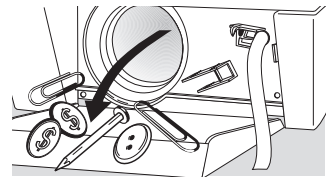

5. Check that you are able to turn the pump wheel at the very rear of the pump housing. (If the wheel rotates with a jerky motion, this is normal.) If you cannot turn the pump wheel, contact customer service.

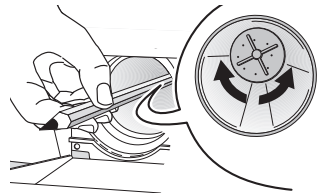

6. Replace the cover. Insert the webs on the cover laterally into the guide slots and screw on the cover securely clockwise.

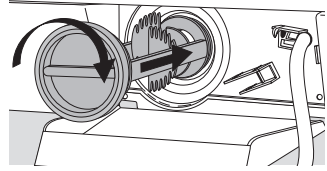

7. Close the emergency emptying hose and place it in the holder.

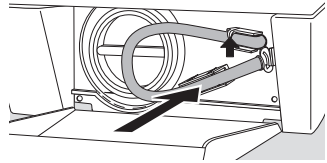

8. Close the flap.

# What to do if ...

## Trouble Shooting

Try to rectify minor faults on the washing machine with the aid of the instructions given here. If you call out an engineer to resolve a fault listed here, or to repair a fault caused by incorrect use or installation, a charge will be made even if the appliance is under guarantee.

Problem	Possible cause	Remedy
The washing machine does not work.	The mains plug is not inserted.	Insert the mains plug.
	The house fuse has blown.	Replace the fuse.
	The door is not closed properly.	Close the door. There should be an audible click.
	The START/PAUSE button was not pressed for long enough.	Press and hold the START/PAUSE button until the programme starts.
The door cannot be closed.	The child safety feature is engaged.	Release child safety feature (see Section "Child Safety Feature").
The display flashes 4 times and an acoustic signal is emitted 4 times	The door is not closed properly.	Close the door properly. Start the programme again.
The END light flashes once and an acoustic signal is emitted once.	The water tap is closed.	Open the water tap. Start the programme again.
	The filter in the socket of the inlet hose is blocked.	Close the water tap. Disconnect the hose from the water tap, remove the filter and clean under running water.
	Water tap is blocked with limescale or is faulty.	Check the water tap and have it repaired if necessary.

Problem	Possible cause	Remedy
The washing machine vibrates when operating, or is noisy.	Transit packaging was not removed.	Remove the transit packaging as described in the Installation and Connection instructions.
	The machine is not level.	Adjust the feet according to the Installation and Connection instructions.
	There is very little washing in the drum (for example one dressing gown).	This does not affect the operation of the machine.
	Water could not be fully drained out before spinning because the drain hose is kinked or the water pump is blocked.	Check the drain hose and remove any kinks if necessary or clean the water pump and if necessary remove any foreign bodies from the pump housing.
Excessive foaming during the main wash.	Probably too much detergent has been used	It may be necessary to reduce the amount of detergent used. Follow the detergent manufacturer's recommendations.
Water leaks out of the washing machine.	The screw connection of the inlet hose is leaking.	Tighten the inlet hose screw connection.
	The drainage hose is leaking.	Check the drainage hose and replace if necessary.
	The drain pump cover is not correctly closed.	Close the cover correctly.
	Washing is caught in the door.	Stop the programme, remove the washing caught in the door. Restart the programme.
	The emergency emptying hose is not correctly closed or is leaking.	Close the emergency emptying hose (see Section "Carry out emergency emptying"). Call your local Service Force Centre if the emergency emptying hose is leaking.
Fabric softener was not rinsed in, the  compartment is filled with water.	The insert in the conditioner compartment is not correctly attached or is blocked.	Clean the detergent dispenser drawer and attach the conditioner insert correctly.

Problem	Possible cause	Remedy
Washing is heavily creased.	Probably too much washing has been put in the drum.	Pay attention to the maximum load quantity (see Programme Tables). In the case of easy-care fabrics, select the EASY IRON programme.
Washing is not thoroughly spun, water remains visible in the drum. The END light flashes twice and an acoustic signal is emitted twice.	The drain hose is kinked.	Remove the kink.
	The maximum pump height (outlet height 1 m from the base of the appliance) is exceeded.	Contact your local Service Force Centre. For pumping heights over 1 m a conversion kit is available as a special accessory.
	The drain pump is blocked.	Switch off the machine and disconnect the mains plug. Clean the drain pump.
	For siphon attachments: the siphon is blocked.	Clean the siphon.
The door cannot be opened when the washing machine is on. START/PAUSE and DOOR lights come on.	Door is locked due to high water level, or high temperature.	Wait until the programme has ended, the DOOR light goes off and the END light is lit.
		If it is necessary to open the door immediately, Turn the programme selector to OFF; then turn it to DRAIN. Press the START/PAUSE button. When the water has been pumped out, the door can be opened.
Power failure during a wash programme (all indicator lights are off).	The failure may be caused by a blown house fuse or by a mains supply fault into the house. (For safety reasons, the door remains locked for around 2 minutes.)	The programme continues when power is restored.
		If washing has to be taken out during a power cut: Turn the control knob to OFF. Carry out emergency emptying (see Section "Carry out emergency emptying"). After about 2 minutes, the door can be opened by pulling on the handle.

Problem	Possible cause	Remedy
Remnants of detergent are building up in the detergent drawer.	The water tap is not fully opened.	Open the water tap fully.
	The inlet hose filter in the inlet coupling of the inlet hose at the tap is blocked.	Close the water tap. Unscrew the inlet hose from the water tap and from the machine. Clean the filter.
The rinse water is cloudy.	The cause is probably a detergent with a high silicate content.	This has no negative effects on rinse results; use a liquid detergent if necessary.
When pressing a programme option button, the corresponding indicator does not light up.	The selected programme option cannot be combined with the set programme.	Make another selection.

## **If the washing results are not satisfactory**

### **If the washing turns greyish and limescale deposits are present in the drum**

- Insufficient detergent has been added.
- Incorrect detergent was used.
- Stains were not pre-treated.
- Programme or temperature was not set correctly.
- If using modular detergents, the individual components were not used in the correct ratio.

### **If there are still grey stains on the washing**

- Soiled garments with ointments, grease or oils were washed with insufficient detergent.
- The temperature selected for the wash was too low.
- A frequent cause is that fabric softener - particularly a concentrated one - has come into contact with the washing. Wash out these types of stains as soon as possible and use the fabric softener carefully.

### **If after the last rinse foam is still visible**

- Modern detergents can still cause foam in the final rinse cycle. However, the washing is still sufficiently rinsed.

### **If there are white residues on the washing**

- These are insoluble contents of modern detergents. They are not the result of an insufficient rinse. Shake out the washing or brush it off. Turn the washing inside out before washing it. Review your choice of detergent and if necessary use liquid detergent.



## Carrying out an emergency emptying

- If the washing machine no longer pumps out the water, emergency emptying must be carried out.
- If the washing machine is located in a room in which below freezing temperatures might occur, emergency emptying must be carried out. Furthermore: unscrew the inlet hose from the water tap and drain off the water. Empty the drainage hose.



**Warning!** Switch off the washing machine and pull out the mains plug prior to performing emergency emptying.

**Warning!** The water, which flows out of the emergency emptying hose can be hot. First allow the water to cool down before you carry out the emergency emptying.

-  **1.** Have a flat container on hand to catch the water.
- 2.** Pull down the flap in the right corner of the base strip outwards and pull it off.

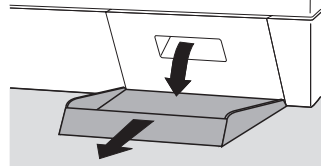

- 3.** Remove the emergency emptying hose from its holder.

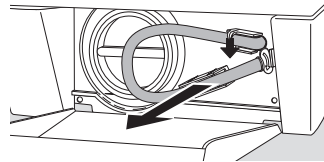

- 4.** Place the container under the hose.
- 5.** Detach the plug of the emergency emptying hose by turning it anticlockwise and pull it out.

The water runs out. Depending on the amount of water, it may be necessary to empty the collecting vessel several times. To do this, close the emergency emptying hose temporarily with the plug.

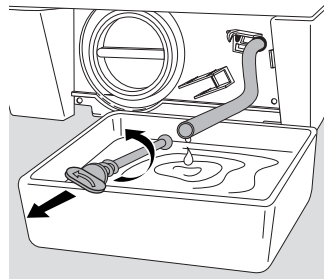

Discard the water from the container, replace it under the emergency emptying hose and remove the plug from the hose.

**When the water is completely drained:**

6. Push the plug securely into the emergency emptying hose and turn it clockwise to secure it.
7. Replace the emergency emptying hose in its holder.
8. Put on the flap and close.

**Additional rinse cycles (RINSE+)**

The washing machine is set for very economical water consumption. However, people who suffer from allergies to detergents, it can be helpful to rinse with extra water.

-  If RINSE+ is selected, two extra rinses are added to the COTTONS/LINEN, EASY-CARES, EASY IRON, and DELICATES programmes. When delivered, the machine is not set for additional rinses.

**To set the additional rinse cycles:**

-  1. Turn the programme selector to COTTONS/LINEN, EASY-CARES/ EASY IRON or DELICATES (any temperature).
2. Press and hold PRE WASH and QUICK at the same time for at least 2 seconds. On the programme progress display the RINSE and RINSE+ lights come on. The additional rinse cycles are set. It remains set until cancelled again.

-  The additional rinse cycles raise water consumption and extend programme times.

**To cancel the additional rinse cycles**

-  1. Turn the programme selector to COTTONS/LINEN, EASY-CARES/ EASY IRON or DELICATES again.
2. Press and hold PRE WASH and QUICK at the same time for at least 2 seconds. RINSE+ goes off on the programme progress display. The additional rinse cycles are cancelled.

## Child Safety Feature

If the child safety feature is set, the door cannot be closed and no washing programme can be started.

### Setting the child safety feature



Use a coin to turn the rotary knob on the inside of the door clockwise as far as it will go.

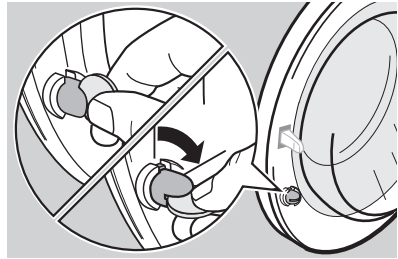

**Warning!** The rotary knob must not be in a vertical position after adjustment, otherwise the child safety feature is not active. The rotary knob must project as shown in the diagram.

### Cancelling the child safety feature



Turn the rotary knob anticlockwise as far as it will go.

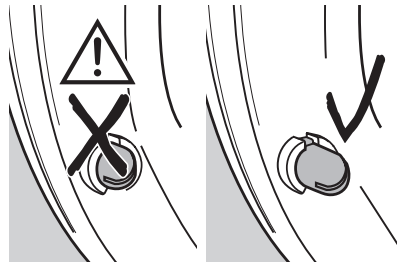

# Installation and connection instructions

## Installation Safety Precautions

- When moving do not tilt the washing machine onto its front or onto its right hand side (viewed from the front). This is to prevent the possibility of the electronic components becoming wet.
- Before installation inspect the machine for transport damage. Do not connect the appliance if it is damaged - contact your retailer.
- Ensure all packaging and transit bolts/bars have been removed, see „Removal of Transit Packaging“. Failure to remove transit bolts/bars may cause serious damage to the appliance or property.
- Always insert the plug into a correctly installed earthed socket.
- Any plumbing work required to install this appliance should be carried out by a plumber or competent person.
- Check that the electricity supply is the same as that indicated on the appliance's rating plate.
- Any electrical work required to install this appliance should be carried out by an electrician or competent person.

# Installation of the appliance

## Transporting the appliance

- Do not place the washing machine on its front or on its right hand side (viewed from the front). This is to prevent the possibility of the electronic components becoming wet.
- Never transport the unit without the transport packaging and bolts/bars. Do not remove the transport packaging until the appliance is at the installation location. Transporting the unit without the transport packaging can damage it.
- Never lift the appliance by the door.
- When transporting the unit with a sack trolley: Attach the sack trolley at the side only.

## Remove transport packaging

**Important!** It is essential to remove the transport packaging before putting the appliance into operation. Keep all parts of the transport packaging in a safe place for future use.

1. Open both hose holders on the appliance's rear side and remove the hoses and mains cable.

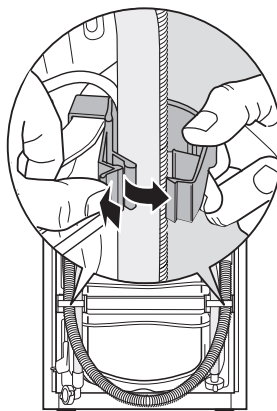

2. Pull both hose holders off the appliance with a strong pull.

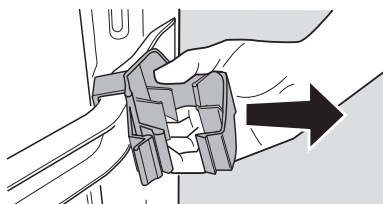

**i** The special spanner (A) and the caps (B) (2 each) and (C) (1 each) are supplied with it.

3. Remove the screw D, including the compression spring with the special spanner A.

4. Cover the hole with the cap C.

**Important!** When fitting the plastic caps, press until they snap into the rear panel securely.

5. Remove the two screws (E) with the special spanner (A).

6. Remove the 4 screws (F).

7. Remove the transit bar (G).

8. Screw the 4 screws (F) back in for safe keeping.

9. Close the 2 large holes with the caps (B).

**Important!** When fitting the plastic caps (B), press until they snap into the rear panel securely.

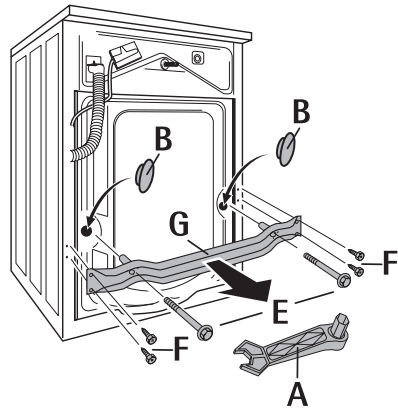
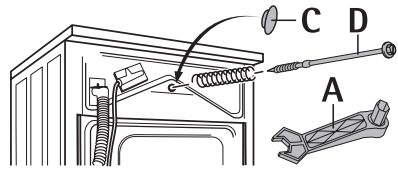

## Installation-Site preparation

- The installation surface must be clean, dry and level. Do not install on a deep pile carpet.
- Minor unevenness of the floor surface should never be levelled out by laying pieces of wood, card or similar materials, but should always be compensated for by adjusting the screw feet.
- If the appliance is installed next to a heat source (e.g. cooking appliance), a heat insulating pad (87 x 57 cm) must be placed between the appliance and the heat source.
- Do not install the appliance in locations where the temperature may fall below freezing.
- Please ensure that when the appliance is installed it is easily accessible for the engineer in the event of a breakdown.

## Installation on a Suspended Floor

Suspended wooden floors are particularly susceptible to vibration. To help prevent vibration we recommend you place a waterproof wood panel, at least 15 mm thick under the appliance, secured to at least 2 floor beams with screws. If possible install the appliance in one of the corners of the room, where the floor is more stable.

## Levelling the Appliance

Floor unevenness can be compensated for and the height can be corrected with the four adjustable screw feet. The height can be adjusted in a range of +10 ... -5 mm.

To adjust the feet use the special spanner supplied.

1. Slide the special key firmly onto the hexagon head of the threaded foot as far as it will go.
2. Adjust the screw feet so that the appliance is horizontal and stable.
3. Check that the appliance is level using a spirit level.

**Important.** Never use strips or shims of wood or cardboard etc. To compensate for any unevenness in the floor. Always use the adjustable feet.

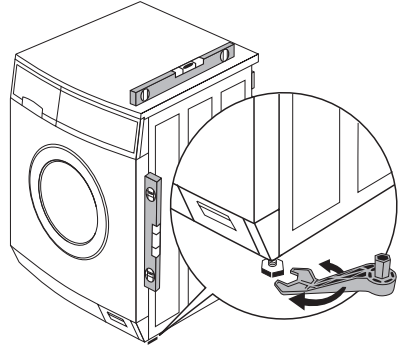



# Electrical Connection

Any electrical work required to install this appliance should be carried out by a qualified electrician or competent person.



## WARNING - THIS APPLIANCE MUST BE EARTHED.

The manufacturer declines any liability should these safety measures not be observed.

Before switching on, make sure the electricity supply voltage is the same as that indicated on the appliance rating plate.

The rating plate is located at the top of the rim of the open door.

The appliance is supplied with a 13amp plug fitted. In the event of having to change the fuse in the plug supplied, a 13amp ASTA approved (BS 1362) fuse must be used.

Should the plug need to be replaced for any reason, proceed as described below.

The wires in the mains lead are coloured in accordance with the following code:

Green and Yellow:	Earth
Blue:	Neutral
Brown:	Live

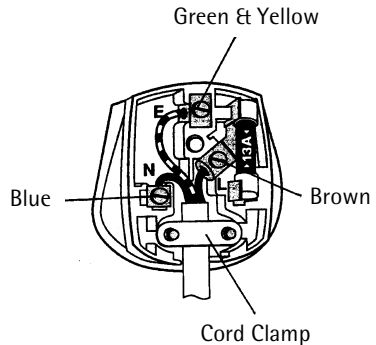
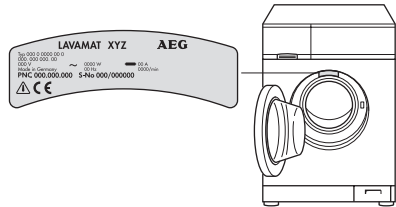

- The wire coloured green and yellow must be connected to the terminal marked with the letter "E" or by the earth symbol  $\oplus$  or coloured green and yellow.
- The wire coloured blue must be connected to the terminal "N" or coloured black.
- The wire coloured brown must be connected to the terminal marked "L" or coloured red.
- Upon completion there must be no cut, or stray strands of wire present and the cord clamp must be secure over the outer sheath.



**WARNING! A cut off plug inserted into a 13 amp socket is a serious safety (shock) hazard. Ensure that the cut off plug is disposed of safely.**

## Permanent Connection

In the case of a permanent connection it is necessary that you install a double pole switch between the appliance and the electricity supply (mains), with a minimum gap of 3 mm between the switch contacts and of a type suitable for the required load in compliance with the current electrical regulations.

The switch must not break the yellow and green earth cable at any point.



This appliance is in accordance with the following EU Guidelines:

- Low Voltage Guidelines 73/23 EEC dated 19 February 1973, include Guideline Change Notice 93/68 EEC
- EMC Guideline 89/336 EEC dated 3 May 1989, including Guideline Change Notice 92/31 EEC.

This appliance complies with the requirements laid out in the EEC Directive 76/899.

Voltage 240 V AC: Fuse rating 13 amps

See rating plate for further information.

This appliance meets VDE requirements.

Particular regulations of local electricity authorities must be observed. This appliance conforms to EEC Directive No. 82/499/EWG on radio interference.



**WARNING!** Repairs to electrical appliances must only be carried out by trained personnel. Improper repairs may lead to serious risks for the user.

## Water connection



The washing machine is provided with safety devices preventing back-contamination of the water supply and complies with local water authority requirements.

This appliance is designed to be permanently plumbed into your home's water supply.

Before connecting up the machine to new pipework or to pipework that has not been used for some time, run off a reasonable amount of water to flush out any debris that may have collected in the pipes.

### **Important!**

- Appliances for connecting to cold water must not be connected to hot water.
- Only use new hose sets for the connection.

## Water pressure

The appliance is designed to operate within the following water pressure units. Minimum 1 bar (=  $10\text{N/cm}^2 = 0.1\text{ Mpa}$ ), maximum 10 bar (=  $100\text{N/cm}^2 = 1\text{ Mpa}$ ).

- If more than 10 bar: Install a pressure-reduction valve upstream
- If less than 1 bar: Unscrew the inlet hose from the appliance at the inlet solenoid valve and remove the flow regulator (to do this, remove the filter with needle nose pliers and remove the rubber washer behind the filter). Replace the filter.

## Inlet Hose Connection

A pressure hose of 1.35m in length is supplied.

If a longer inflow hose is required, only a VDE-approved, complete set of hoses with fitted hose screw connections is permissible, available from AEG Service Force Centres.

- Hose sets in lengths of 2.2m, 3.5m, and 5m are available for washing machines without Aqua-Control.
- Hose sets in lengths of 2.0m, 2.9m and 3.9m are available for washing machines with Aqua-Control.

**Important!** Never cut into pieces in order to extend the hoses!



Sealing rings are supplied either in the plastic nuts of the hose screw connection or in the enclosed pack. Do not use other seals!



1. Connect the hose with the angled connection to the machine.

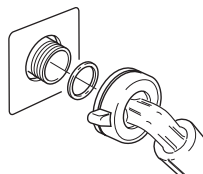

**Important!**

- Do not lay the inlet hose vertically downwards, instead run it to the right or left as shown in the diagram.
- Tighten firmly to prevent leakage but do not use excessive force.

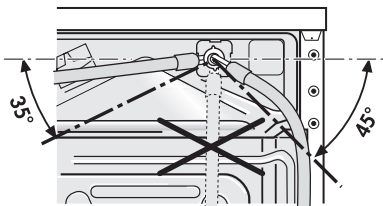

2. Connect the hose with the straight connection to a water tap with a screw thread R 3/4 (inches)

**Important!** Only tighten the screw connection by hand.

3. By slowly opening the water tap before putting the washing machine into operation, check that the connection is free of leaks.

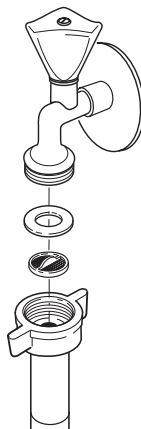

## Water Drainage

The appliance drain hose should hook into a standpipe, the hook in the drain hose is formed using the plastic "U-Piece" supplied. The standpipe should have an internal diameter of approximately 38 mm (see diagram) thus ensuring there is an air break between the drain hose and standpipe.

**Important!** It is essential to lay the drainage hose without kinks.

When discharging into a standpipe ensure that the top of the curve in the hose end is no more than 90 cm (35.4") and no less than 60 cm (23.6") above floor level.

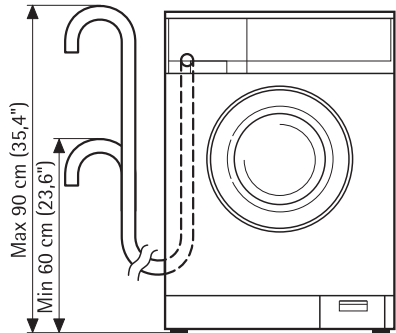

The upright standpipe should have a minimum length of 30 cm (12") from the bottom of the elbow to the top of the pipe (see diagram). Make sure that it is designed in such a way that the end of the drain hose cannot be covered with water.

Longer drain hoses are available in lengths of 2.7 and 4 metres from your AEG Service Force Centre.

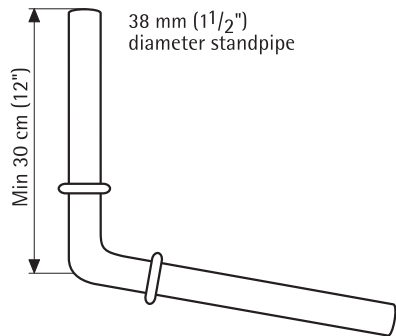

If you intend the drain hose from the washing machine to empty into a sink, make sure that the sink is empty and the plug hose is not blocked. Use the plastic "U-Piece" supplied.

**Important!** The end of the drainage hose must not be submerged in the pumped-out water. Otherwise, the water could be sucked back into the appliance.

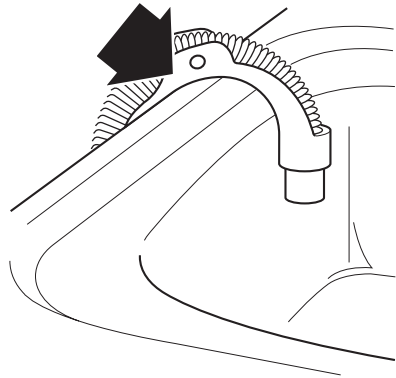

## Pump head of greater than 1m

Every washing machine includes a wash water pump for the removal of wash and rinse water, which can pump fluids through the outlet hose up to a height of 1m, measured from the surface on which the machine stands.

For pump heads of greater than 1m please contact your local AEG Service Force Centre.

## Technical data

Height Adjustment  
Load (depending on the programme)  
Area of use  
Drum speed, spinning  
Water pressure

approx. +10 / -5mm  
max. 5kg

Domestic  
see rating plate  
1-10bar  
(=10-100 N/cm<sup>2</sup>= 0.1-1.0 Mpa)

## Dimensions

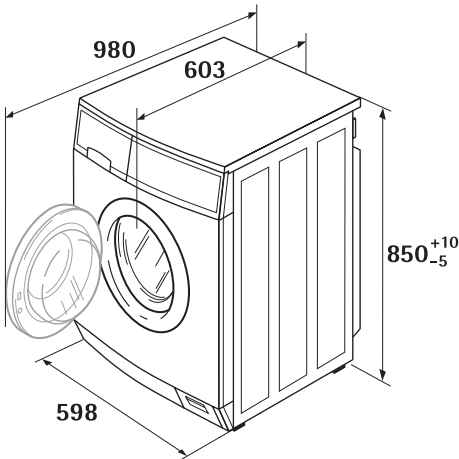

(dimensions in mm)

# Warranty conditions

## Great Britain

### Guarantee Conditions

AEG offer the following guarantee to the first purchaser of this appliance.

1. The guarantee is valid for 12 months commencing when the appliance is handed over to the first retail purchaser, which must be verified by purchase invoice or similar documentation.  
The guarantee does not cover commercial use.
2. The guarantee covers all parts or components which fail due to faulty workmanship or faulty materials. The guarantee does not cover appliances where defects or poor performance are due to misuse, accidental damage, neglect, faulty installation, unauthorised modification or attempted repair, commercial use or failure to observe requirements and recommendations set out in the instruction book.  
This guarantee does not cover such parts as light bulbs, removable glassware or plastic, dust bags or filters.
3. Should guarantee repairs be necessary the purchaser must inform the nearest customer service office (manufacturer's service or authorised agent). AEG reserves the right to stipulate the place of the repair (i. e. the customer's home, place of installation or AEG workshop).
4. The guarantee or free replacement includes both labour and materials.
5. Repairs carried out under guarantee do not extend the guarantee period for the appliance. Parts removed during guarantee repairs become the property of AEG.
6. The purchaser's statutory rights are not affected by this guarantee.

### European Guarantee

If you should move to another country within Europe then your guarantee moves with you to your new home subject to the following qualifications:

- The guarantee starts from the date you first purchased your product.
- The guarantee is for the same period and to the same extent for labour and parts as exist in the new country of use for this brand or range of products.
- This guarantee relates to you and cannot be transferred to another user.
- Your new home is within the European Community (EC) or European Free Trade Area.
- The product is installed and used in accordance with our instructions and is only used domestically, i. e. a normal household.
- The product is installed taking into account regulations in your new country.

Before you move please contact your nearest Customer Care Centre, listed below, to give them details of your new home. They will then ensure that the local Service Organisation is aware of your move and able to look after you and your appliances.

France	Senlis	+33 (0) 44 62 29 29
Germany	Nürnberg	+49 (0) 800 234 7378
Italy	Pordenone	+39 (0) 800 117511
Sweden	Stockholm	+46 (0) 8 672 5360
UK	Slough	+44 (0) 1753 219899





# Index

## C

- Cancelling the programme ..... 20
- Changing the programme ..... 20
- Child safety feature .....28, 35
- Coloureds .....10, 22
- Conditioner .....9, 15, 16, 18
- Cottons ..... 10, 14, 22
- Curtains ..... 13
- Customer Service .....25, 51

## D

- Delicates ..... 11, 14, 22
- Detergent .....9, 15, 16, 18
- Detergent dispenser drawer .....9, 18
- Drain ..... 11, 20, 21
- Drain pump .....9, 26

## E

- Easy iron .....11, 22
- Easy-cares ..... 11, 14, 22
- Eco valve ..... 13
- Emergency emptying ..... 33
- Energy saving ..... 11

## G

- Gentle rinse .....11, 23

## H

- Handwash ..... 11, 22, 23

## I

- In-wash stain treatment ..... 9

## L

- Linen ..... 14
- Load .....12, 22

## N

- Net curtains ..... 22

## O

- Opening the door .....17, 30

## P

- Pre-wash .....11, 18, 19, 22
  - detergent .....9, 18
- Programme progress display ..... 20

## Q

- Quick .....12, 19, 20, 22

## R

- Rating plate ..... 9, 41, 42, 51
- Rinse hold .....11, 19, 21
- Rinse+ .....34
- Risk of frost ..... 6, 33

## S

- Silk .....11, 14, 23
- Softener ..... 9, 18
- Spinning .....11, 16, 19, 21, 23
- Stain ..... 12, 19, 20, 22

## W

- Warranty ..... 6, 48
- Water
  - hardness .....15
  - softener ..... 15, 18
- Wool ..... 11, 14, 22, 23
  - hand washable ..... 11, 22

## Service & Spare Parts

If after carrying out the necessary checks there is still a fault with your appliance please contact your local AEG Service Force Centre.

**In guarantee customers should ensure that the suggested checks have been made as the engineer will make a charge if the fault is not a mechanical or electrical breakdown.**

Please note that proof of purchase is required for in-guarantee service calls.

### Service & Spare Parts

If you require a service engineer or wish to purchase spare parts, contact your local AEG Service Force Centre, by telephoning:

**0870 5 929 929**

### Help us to help you

Please determine your type of enquiry before telephoning. When you contact us we need to know.

1. Your name, address and post code.
2. Your telephone number.
3. Clear and concise details of the fault.
  - What is the fault?
  - When does the fault occur?
4. The model, production number and product identification number.
5. Date of purchase.

This information can be found on the rating plate, so you have these numbers to hand we recommend you write them below.

PNC .....

S-No. ....

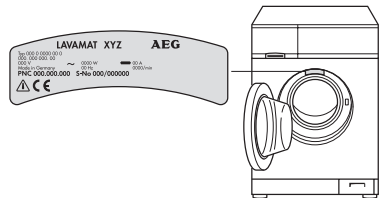

### Customer Care

For general enquiries regarding your AEG appliance, or further information on AEG products please contact our customer care department by letter or telephone at the address below or visit our website at

**[www.aeg.co.uk](http://www.aeg.co.uk)**

Customer Care Department  
 AEG Domestic Appliances  
 55-77 High Street, Slough, Berkshire SL1 1DZ  
 Tel: 08705 350350\*

\*Calls to this number may be recorded for training purposes.

*The Electrolux Group is the world's largest producer of powered appliances for kitchen, cleaning and outdoor use. More than 55 million Electrolux Group products (such as refrigerators, cookers, vacuum cleaners, chain saws and lawn mowers) are sold each year to a value of approx. 14 billion USD in more than 150 countries around the world.*



***From the Electrolux Group. The world's No.1 choice.***

AEG Hausgeräte GmbH  
Postfach 1036  
D-90327 Nürnberg

<http://www.aeg.hausgeraete.de>

© Copyright by AEG

822 943 182-01-070502-02

Subject to change without notice