

LAVAMAT 74810

Washing Machine

User information



Dear Customer,

Please read this user information carefully and keep it to refer to later. Please pass the user information on to any future owner of the appliance.

The following symbols are used in the text:



Safety instructions

Warning! Information that affects your personal safety.

Important! Information that prevents damage to the appliance.



Useful tips and hints



Environmental information

Contents

Operating Instructions	5
Safety	5
Description of the appliance	7
Control panel	7
Programme overview	8
Before the first wash	10
Preparing and sorting washing	10
Running a wash cycle	11
Opening the door/loading washing.....	11
Adding detergent /conditioner	11
Switching on the appliance/selecting a programme	13
Changing the spin speed/selecting rinse hold	13
Selecting additional programmes	14
RINSE +	14
TIME SAVER.....	14
PRE WASH.....	14
STAIN	14
SENSITIVE	14
Setting the delay timer	15
Starting a programme.....	15
Programme sequence	15
Interrupting a programme/adding washing	16
End of the wash cycle/removing the washing	16
Overdosing	16
Child safety device	17
Cleaning and maintenance	18
What to do if....	19
Remedying small faults yourself	19
If the wash result is not satisfactory	21
Carrying out an emergency drain	22
Drain pump.....	23
Disposal	24
Technical data	25
Consumption values	25

Installation and connection instructions	26
Safety information concerning installation	26
Installing the appliance	27
Transporting the appliance.....	27
Removing the transit packaging	27
Where to install	28
Making the appliance level.....	29
Electrical Connection	30
Connecting the appliance to the water supply	31
Water inlet	32
Water Drainage	33
Warranty conditions	35
Customer Service Centres	37
Service and Spare Parts	39

Operating Instructions



Safety

Prior to using the appliance for the first time

- Follow the “**Installation and connection instructions**”.
- If the appliance is delivered in the winter months when there are minus temperatures: store the washing machine at room temperature for 24 hours before using for the first time.

Correct use

- The washing machine is only designed for the washing of normal domestic laundry at home.
- Additions or modifications to the washing machine are not permitted.
- Only use detergents/conditioners that are suitable for use in domestic washing machines.
- The washing must not contain any flammable solvent. The risk of explosion exists.
- Do not use the washing machine for dry cleaning.
- Dyes/colour removers may only be used in the washing machine, if the manufacturer of these products expressly permits this. We cannot accept liability for any damage arising.

Child safety

- Keep packaging away from children. There is a risk of suffocation.
- Children often do not recognise the hazards associated with electrical appliances. Don't allow children to use the washing machine unsupervised.
- Make sure that children and pets don't climb into the drum of the washing machine. The risk of death exists.

General safety

- Repairs to the washing machine may only be carried out by qualified/ authorised service engineers.
- Never use the appliance when the electrical cable is damaged or the control panel, worktop or plinth area are damaged to such an extent that the inside of the appliance is openly accessible.
- Switch off the washing machine prior to cleaning it and carrying out maintenance. In addition, remove the power plug from the power point or – if the appliance has been hard-wired – switch off the cut-out in the fuse box or completely remove the fuse.
- If operation is stopped, disconnect the appliance from the mains supply and turn off the tap.
- Never remove the power plug from the power point by pulling on the cable. Always pull the plug.
- Multiway-plugs, connectors and extension cables must not be used.
Resulting overheating may constitute a fire hazard.
- Never wash the washing machine down with a water jet. Danger of electric shock.
- When using wash programmes with high temperatures the glass in the door will become hot. Do not touch it!
- Before emergency emptying of the appliance, before cleaning the drain pump or opening the door in an emergency, let the water cool down.
- Small animals can nibble on electrical cables and water hoses. This can constitute a risk of electrocution and water damage. Keep small animals away from the washing machine.

Description of the appliance

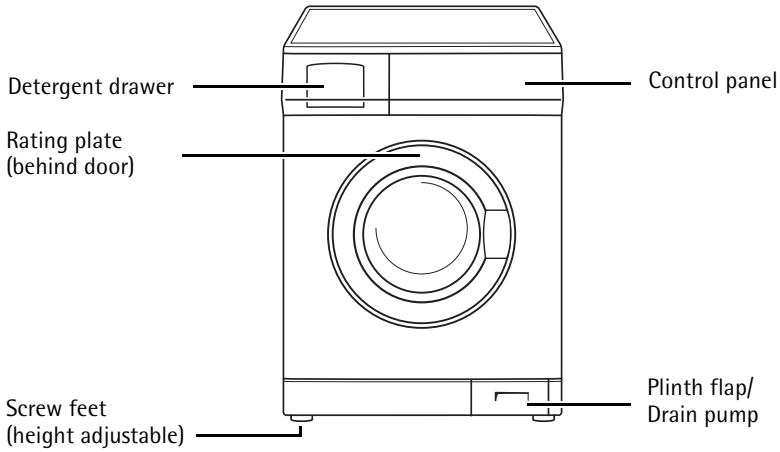

Control panel

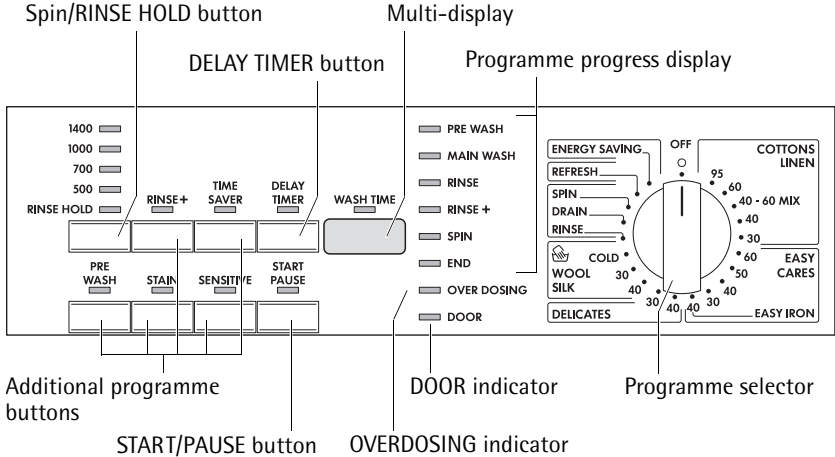

Programme overview

































Programme	max. load ¹⁾ (dry washing)	Additional programmes					Spin speed		
		RINSE +	TIME SAVER	PRE WASH	STAIN	SENSITIVE	1400	1000/700/500	RINSE HOLD
ENERGY SAVING ²⁾	6 kg	•		•	•	•	•	•	•
COTTONS/LINEN 95, 60, 40, 30	6 kg	•	• ³⁾	•	• ⁴⁾	•	•	•	•
40-60 MIX	6 kg	•		•	•	•	•	•	•
EASY-CARES 60, 50, 40, 30	3 kg	•	•	•	• ⁴⁾	•		•	•
EASY IRON 40	1 kg	•	•	•	•			•	•
DELICATES 40, 30	3 kg	•	•	•				•	•
WOOL/SILK  (Hand-washing) 40, 30, COLD	2 kg							•	•
RINSE	3 kg							•	•
DRAIN									
SPIN	6 kg						•	•	
REFRESH	3 kg							•	•

1) A 10 litre bucket contains approx. 2.5 kg dry washing (cotton)

2) Programme settings for tests in accordance with or in the style of EN 60 456 and IEC 60 456 are described in the chapter "Consumption values".

3) Recommended load for short programmes is 3 kg; full loading is possible however with somewhat reduced cleaning results.

4) STAIN can only be set from 40° upwards, as stain removal agent only becomes effective at higher temperatures.

Application/Features	Care symbols ¹⁾
Energy-saving programme which washes at 60 °C for lightly to normally soiled whites or coloureds made of cotton/linen.	 
Programme for normally to heavily soiled whites/coloureds made of cotton/linen.	  
Programme for cottons/linen, which is indicated for various wash temperatures. Items which according to their care label are normally washed separately at 40 °C or at 60 °C, can be washed together in this programme. In this way the drum capacity is better used, saving energy. Achieves the washing results of a normal 60° programme.	 
Programme for easy-care mixed fibres and synthetics.	  
Special programme which washes at 40 °C for easy-care fabrics which after being washed using this programme need to be ironed only lightly or not at all.	 
Gentle programme for delicate textiles such as bonded fibres, micro-fibres, synthetics, net curtains (load max. 20 to 25 m ² curtains). If used together with RINSE HOLD, also suitable for fabrics with climatic membranes, e.g. outdoor clothing.	 
Specially gentle programme for machine and hand-washable wool/silk.	  
Separate gentle rinse (3 rinse cycles, liquid conditioner is washed in from the compartment  , gentle spin).	     
Draining following a rinse hold.	
Draining and spinning, e.g. following a rinse hold, or separate spinning of hand-washed cottons/linen.	  
Special programme which washes at 30 °C, approx. 30 minutes, for brief washing of e.g. worn-once, lightly soiled sports clothing or new clothes.	     

1) The figures in the care symbols indicate the maximum temperatures.

Before the first wash

1. Open the detergent drawer.
2. Pour approx. 1 litre of water through the detergent drawer into the washing machine.
This closes the water container when the next programme is started and the economy valve can function properly
3. To remove any production-related residues from the drum and water tank, perform the first wash cycle without a load. Programme: COTTONS/LINEN 60, press the TIME SAVER button, add approx. 1/4 measuring cup of detergent.

Preparing and sorting washing

Preparing washing

- Empty the pockets. Remove foreign bodies (e.g. coins, paper clips, nails, etc.).
- Do up zips, button up covers to prevent damage to washing.
- Remove the runners from net curtains or cover them with a net or a bag.
- Wash delicate and small items in a net/pillowcase, e. g. net curtains, tights, small socks, handkerchiefs, bras.

Important: Bras and other items containing wires should only be washed in a net bag. The wires can work loose and damage the appliance.

Sorting washing

- By colour: Wash white and coloured washing separately. Washing can run.
- By temperature, type of washing and care symbol.

Important: Do not wash fabrics with the  care symbol (= do not wash!) in the washing machine.

Running a wash cycle

Opening the door/loading washing

1. Open the door: pull the handle on the door.

When the appliance is switched on, the DOOR and START/PAUSE indicators show whether the door can be opened:

DOOR indicator	START/PAUSE indicator	Can the door be opened?
illuminated green	flashing red or not illuminated	yes
illuminated green	illuminated red	yes, after pressing the START/PAUSE button
illuminated red or not illuminated	flashing red or illuminated red	no, water level and/or temperature too high

2. Separate washing and load it loosely. Mix large and small items.

Important: Do not get any washing caught between the door and the rubber seal.

3. Firmly push the door shut. Door catch must audibly click shut.

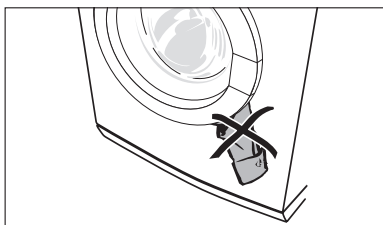

Adding detergent /conditioner

Important: Only use detergents/conditioners that are suitable for use in household washing machines.

Add detergent/conditioner in accordance with the detergent/conditioner manufacturer's instructions. Observe instructions on the packaging.

The amount of detergent used depends on:

– the degree of soiling,

– the load size

– the hardness of the tap water.

- If the manufacturer does not make any recommendations with regard to small volumes of washing: For a half-load use a third less, and for a very small load use only the half the amount of detergent that is recommended for a full load.

- Water softener should be used from water hardness range 2 (=medium). The amount of detergent used can then always be that as for hardness range 1 (=soft). Your local water company will provide you with information about water hardness in your area.

1. Pull out the detergent drawer as far as it will go.
2. Add the detergent/conditioner.
3. Push the detergent drawer in fully.

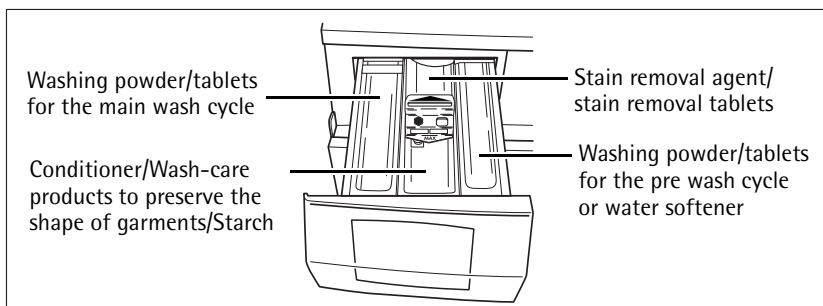

Washing powder/tablets for the main wash cycle

If you are using water softener and require the right compartment for detergent for the pre-wash cycle, add the water softener on top of the detergent for the main wash cycle in the left compartment.

Softener, wash-care products to preserve the shape of garments, starch

Fill the compartment to no more than the MAX indicator. Add water to thick liquid concentrates in accordance with the manufacturer's instructions before using them. Dissolve powder starch.

If you are using liquid detergent:

Add liquid detergent using measuring containers provided by the detergent manufacturer.

Switching on the appliance/selecting a programme

Set the programme and temperature using the programme selector.

- i** The appliance is switched on by selecting a programme.
- The programme progress display shows the programme steps that the selected programme will carry out.
 - The estimated programme duration (in minutes) appears in the multi-display.

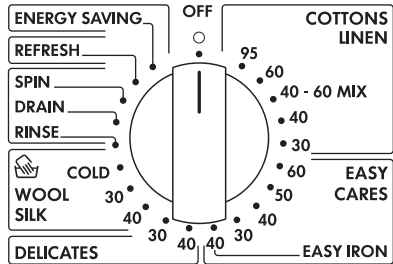

Changing the spin speed/selecting rinse hold

The washing machine suggests the maximum permitted spin speed suitable for the selected programme. You can reduce this spin speed:

To do this, press the Spin/RINSE HOLD button repeatedly until the required indicator is illuminated.

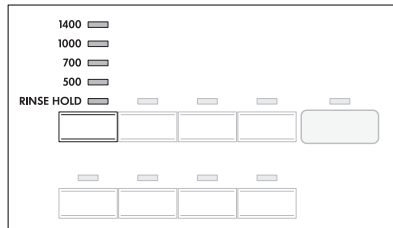

- i** The spin speed for the final spin can be changed even during the programme. To do this:

1. Press the START/PAUSE button.
2. Change the spin speed.
3. Press the START/PAUSE button again.

RINSE HOLD

With RINSE HOLD the washing is left to soak in the final rinse water. No final spin takes place, only the intermediate spin. The intermediate spin depends on the programme and cannot be changed.

Selecting additional programmes

If required, press additional programme button(s). The corresponding indicator will illuminate.



If "Err" flashes in the multi-display, the selected additional programme cannot be used together with the wash programme set.

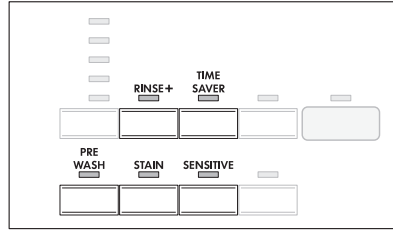

RINSE +

Two additional rinse cycles are carried out for the programmes ENERGY SAVING, COTTONS/LINEN, DELICATES, EASY-CARES and EASY IRON (for example in cases of over-sensitive skin).

TIME SAVER

Shortened wash programme for lightly soiled items.

PRE WASH

Warm pre-wash before the main wash that follows automatically; with intermediate spin for COTTONS/LINEN and EASY-CARES, without intermediate spin for DELICATES.

STAIN

For heavily soiled or stained washing. Stain removal agent will be rinsed into the wash at the optimum point in the programme.

Can only be set for wash temperatures of 40°C and upwards as stain removers only become effective at higher temperatures.

SENSITIVE

Increased effectiveness of the rinse due to the additional rinse cycle together with decreased drum movement (gentle on fabrics). Ideal when frequent washes are necessary, for example in cases of over-sensitive skin.

Setting the delay timer

i Using the DELAY TIMER button you can delay the start of a programme by 30 minutes (30') to a maximum of 23 hours (23h).

1. Select the programme.
2. Press the DELAY TIMER button repeatedly until the desired start delay is shown in the multi-display, e.g. 12h to delay the start of the programme by 12 hours. The DELAY TIMER indicator will illuminate.

i If the display is showing 23h and you press the button again, the time delay will be cancelled. 0' will appear followed by the length of the wash programme that has been set.

3. To activate the delay timer, press the START/PAUSE button. The time remaining to the start of the programme will be continuously shown (e.g. 12h, 11h, 10h,... 30' etc.).

Starting a programme

1. Check that the tap is turned on.
2. Select a programme.
3. Press the START/PAUSE button. The programme is started, or will start after the delay timer has counted down.

i If after pressing the START/PAUSE button E40 flashes in the multi-display, the END indicator flashes 4 times and at the same time an acoustic signal sounds 4 times, the door has not been correctly shut. Push the door firmly closed and press the START/PAUSE button again.

Programme sequence

- The programme progress display shows the programme step that is currently being carried out.
- The multi-display shows the estimated time remaining (in minutes) until the end of the programme.

i The time remaining can increase or stay the same for a while during the course of the cycle as the programme adjusts itself to various conditions (e.g. type of washing and quantity, out of balance spin detection, special rinse cycle, etc.).

Interrupting a programme/adding washing

Interrupting a programme

- A programme can at any time be interrupted by pressing the START/PAUSE button and resumed by pressing START/PAUSE again.
- To cancel a programme before it has ended, turn the programme selector to OFF. **Important:** Be careful of water in the appliance.

Adding washing

Washing can be added, as long as the DOOR indicator is illuminated green.

1. Press the START/PAUSE button. The door can be opened.
2. Close the door and press the START/PAUSE button again. The programme will continue.

End of the wash cycle/removing the washing

At the end of the programme, END lights up on the programme progress display. The door can be opened as soon as the DOOR indicator is lit green.

1. Open the loading door and remove the washing.
2. Turn the programme knob to OFF.
3. Close the water valve.
4. After washing, pull out the detergent drawer a little to enable it to dry out. Keep the loading door very slightly open so that the washing machine can air.

If RINSE HOLD has been selected:

After the rinse hold, END lights up on the programme progress display. The water must first be drained:

- Either turn the programme knob to OFF, then to DRAIN and press the START/PAUSE button (the water is drained without spinning),
- or turn the programme knob to OFF and then to SPIN. Change the spin speed if necessary and press the START/PAUSE button (the water is drained and the washing spun).

Overdosing



If the OVERDOSING indicator is illuminated, too much detergent was used in the previous programme. The next time you wash, observe the detergent manufacturer's instructions concerning amount of detergent required, and the amount of items you wash in one load.

Child safety device

If the child safety device has been activated, the door can no longer be shut.

Activating the child safety device:

Use a coin to turn the knob (on the inside of the door) in a clockwise direction as far as it will go.

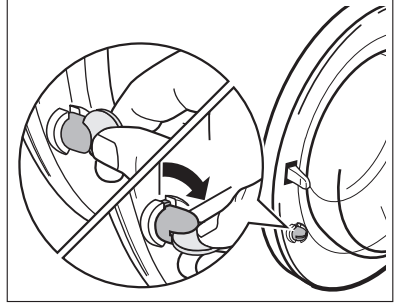

Warning! The knob must not be depressed after being set, otherwise the child safety device is not activated. The knob must stand proud as shown in the illustration.

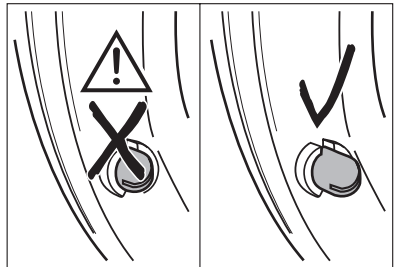

Deactivating the child safety device:

Turn the knob in an anti-clockwise direction as far as it will go.

Cleaning and maintenance

Important! Do not use furniture care products or aggressive cleaners to clean the appliance.

Wipe control panel and body with a damp cloth.

Cleaning procedure

If you plan to wash mainly at low temperature, you should run a hot programme from time to time. This will reduce any deposits and clean the appliance from the inside.

Detergent dispenser drawer

The detergent dispenser drawer should be cleaned regularly.

1. Remove the detergent dispenser drawer by pulling it firmly.
2. Remove the conditioner insert from the middle compartment.
3. Clean all parts with water.
4. Put the conditioner insert in as far as it will go, so that it is firmly in place.

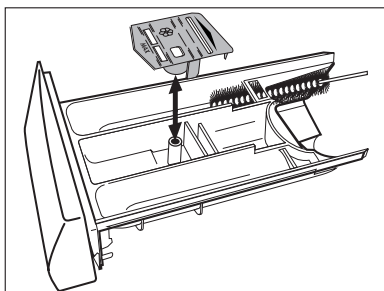

5. Clean all parts of the washing machine, especially the nozzles in the top of the washing-in chamber, with a brush.
6. Insert the detergent dispenser drawer in the guide rails and push it in.

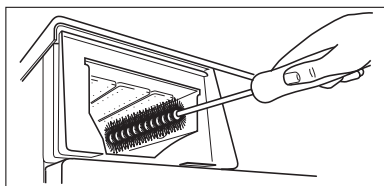

Washing drum

Rust deposits in the drum may occur due to rusting foreign bodies in the washing or tap water containing iron.

Important! Do not clean the drum with acidic descaling agents, scouring agents containing chlorine or iron or steel wool.

1. Remove any rust deposits on the drum with a cleaning agent for stainless steel.
2. Run a washing cycle without any washing to clean off any cleaning agent residues. Programme: COTTONS/LINEN 60, press the TIME SAVER button, add approx. 1/4 measuring cup of detergent.

Door and rubber collar

Regularly check whether deposits or foreign bodies are present in the folds of the rubber collar or on the inside of the glass door.
Clean the glass in the door and the rubber collar regularly.

What to do if...

Remedying small faults yourself

If during use of the appliance one of the following error codes is shown in the multi-display:

- **E iD** (Problems with the water inflow),
- **EzD** (Problems with the water outflow),
- **E4D** (door open),

please consult the following table.

After the error has been remedied, press the START/PAUSE button.

In the event of other errors (**E** and a number or letter): Switch the appliance off and then on again. Set the programme again. Press the START/PAUSE button.

If the error appears again, please contact your local Service Force Centre, stating the error code.

Problem	Possible cause	Remedy
Washing machine is not working.	Mains plug not plugged in or fuse not working.	Connect the plug to a mains socket. Check fuse.
	Loading door not closed properly.	Close loading door - there should be an audible click.
	The START/PAUSE button has not been pressed for long enough.	Press the START/PAUSE for a longer period of time.
The door cannot be closed.	The child safety device has been activated.	Deactivate the child safety device.
When a button is pressed, Err appears in the multi-display.	The selected function cannot be combined with the programme set.	Select another function.
E4D appears. The END indicator flashes 4x, and an acoustic signal sounds 4x.	The door is not closed properly.	Close the door properly. Restart the programme.

Problem	Possible cause	Remedy
E 10 appears. The END indicator flashes 1x, and an acoustic signal sounds 1x. (Problems with water inflow.)	Tap turned off.	Turn on the tap.
	The filter in the threaded inlet hose fitting is blocked.	Turn off the tap. Unscrew the hose, take out the filter and clean it.
	Water tap is furred with lime scale or is faulty.	Check the tap and have it repaired, if necessary.
The washing machine vibrates when operating or is not stable.	The transit packaging has not been removed.	Removing the transit packaging.
	The screw feet not correctly adjusted.	Adjust the feet as described in the installation and connection instructions.
Washing has not been spun.	Only a few large items of washing in the drum.	Always load the drum as full as possible. Mix large and small items.
Water is running out from under the washing machine.	Screw connection on the inlet hose is leaking.	Screw the inlet hose on tightly.
	Drain hose is leaking.	Replace drain hose.
	Drain pump cover is not closed properly.	Close the cover properly.
	Washing was caught in the door.	Load washing carefully for the next wash.
	Emergency drain hose is leaking.	Close off emergency drain hose properly.
Wash water is foaming excessively. At the end of the washing cycle, the spin stops. The OVERDOSING indicator lights up.	Too much detergent has probably been used.	Follow the manufacturer's instructions exactly when measuring out detergent.
E 20 appears. The END indicator flashes 2x, and an acoustic signal sounds 2x. (Problems with water inflow.)	Kink in drain hose.	Straighten the hose.
	Do not exceed the maximum pump height of 1 m.	Please contact customer service.
	Drain pump is blocked.	Switch off the appliance. Disconnect the power plug. Clean the drain pump. Remove foreign bodies from the pump housing.
	For sink spigot connections: The sink spigot is blocked.	Clean the sink spigot.

Problem	Possible cause	Remedy
Fabric softener was not rinsed in, the compartment  for conditioners is full of water.	Fabric softener insert in the compartment for conditioners is not correctly attached or is blocked.	Clean the detergent drawer, insert the fabric softener insert firmly.
The door cannot be opened when the washing machine is switched on.	Door locked.	Wait until the DOOR indicator is illuminated green.
	There has been a power cut. (All the indicator are off). The door remains blocked for approx. 4 to 10 minutes.	The programme will continue when the power cut is over. To remove washing: If water can be seen in the appliance, first drain off the water before opening the loading door (see section "Carrying out an emergency drain").
Washing is heavily creased.	Possibly too much washing was loaded.	Observe maximum loads.

If the wash result is not satisfactory

The washing is grey and there are limescale deposits in the drum

- Too little detergent was used.
- An incorrect detergent was used.
- Individual stains were not pre-treated.
- The programme or temperature was not set properly.

There are grey stains on the washing

- Items that were soiled with ointments, fats or oils were washed using too little detergent.
- The wash temperature used was too low.
- A common cause is that conditioner – in particular the type in concentrated form – has come in contact with the washing. Wash out such marks as soon as possible and exercise care when using the said conditioner.

Foam can still be seen following the final rinse

- Modern detergents can cause foam to be created even during the final rinse. In spite of this, the washing has been sufficiently rinsed.

There are white residues on the washing

- What can be seen here are insoluble substances which modern detergents contain. They are not the result of insufficient rinsing. Shake or brush the washing. If possible turn the washing inside out before washing. Check your choice of detergent. Especially with dark colours it is advisable to use liquid detergents.

Carrying out an emergency drain



Warning! Prior to carrying out an emergency drain, switch off the washing machine and remove the power plug from the power point.

Warning! The water that comes out of the emergency drain hose may be hot. There is a risk of scalding. Let the water cool before performing an emergency drain!

1. Open the plinth flap and remove it.

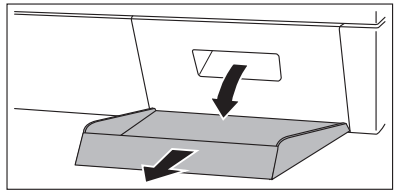

2. Remove the emergency drain hose.

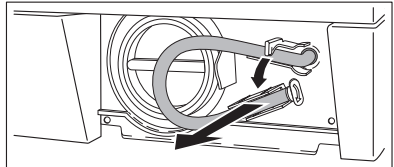

3. Place a shallow container underneath it. Then loosen the drain plug by turning it in an anti-clockwise direction and pull it out.

4. The water will run out. If it is necessary to empty the container more than once, seal up the emergency drain hose with the drain plug while you are doing so.

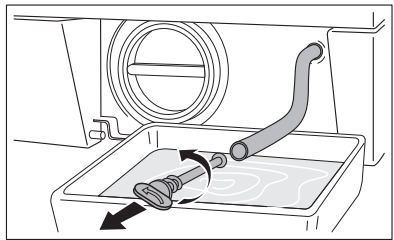

When the water has all drained away:

5. Insert the plug firmly into the emergency drain hose and turn it in a clockwise direction until it is firmly in place.
6. Replace the emergency drain hose into the retainer.
7. Insert the plinth flap into place and close it.

Drain pump

The drain pump is maintenance-free. It is only necessary to open the pump cover if there is a malfunction and water is no longer being pumped out, e.g. if the pump wheel is blocked.

Before loading the machine, please always ensure that there are no foreign bodies present in the pockets or in between the items to be washed. Paper clips, nails, etc. which may find their way into the washing machine along with the washing will remain in the drain pump housing (foreign body trap that protects the pump wheel).



Warning! Before opening the cover of the drain pump, switch off the washing machine and remove the power plug from the power point.

1. First carry out an emergency drain.
2. Place a cloth on the floor in front of the cover of the drain pump. Residual water runs out.
3. Unscrew the pump cover in an anti-clockwise direction and remove it.

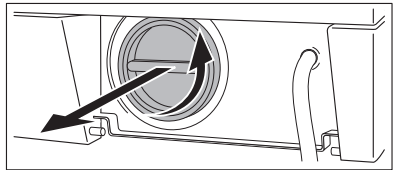

4. Remove foreign bodies and fluff from the pump housing and from the pump wheel.

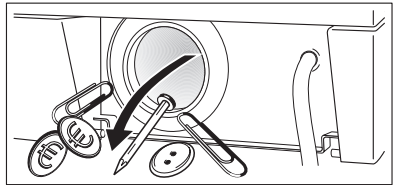

5. Check whether the pump wheel right at the back of the pump housing can turn. (If the wheel rotates with a jerky motion, this is normal.) If the pumping wheel cannot be turned, please contact your local Service Force Centre.

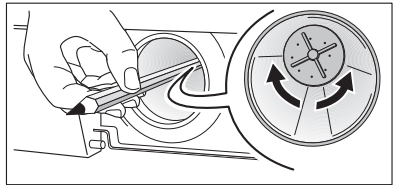

6. Insert the pump cover. Insert the guides at the sides of the cover into the guide slots and tighten the cover by turning in a clockwise direction.
7. Close off the emergency drain hose and place it in the retainer.
8. Close the plinth flap.

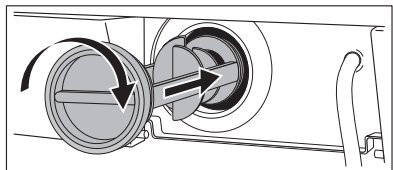

Disposal



Packaging material

The packaging materials are environmentally friendly and can be recycled. The plastic components are identified by markings, e.g. >PE<, >PS<, etc. Please dispose of the packaging materials in the appropriate container at your local waste disposal facilities.



Old appliance



The symbol  on the product or on its packaging indicates that this product may not be treated as household waste. Instead it shall be handed over to the applicable collection point for the recycling of electrical and electronic equipment. By ensuring this product is disposed of correctly, you will help prevent potential negative consequences for the environment and human health, which could otherwise be caused by inappropriate waste handling of this product. For more detailed information about recycling of this product, please contact your local city office, your household waste disposal service or the shop where you purchased the product.



Warning: When your appliance has finished its working life, remove the plug from the mains socket. Cut off the cable and plug and dispose of them.

Destroy the door lock. This prevents children from trapping themselves inside and endangering their lives.

Technical data

- CE** This appliance conforms with the following EU Directives:
- 73/23/EEC dated 19.02.1973 Low Voltage Directive
 - 89/336/EEC dated 03.05.1989 EMC Directive inclusive of Amending Directive 92/31/EEC
 - 93/68/EEC dated 22.07.1993 CE Marking Directive

Height x Width x Depth	850 x 598 x 603 mm
Depth when door is open	980 mm
Height adjustment	approx. +10/-5 mm
Load (depending on programme)	Max. 6kg
Area of use	Domestic
Drum spin speed	see Rating Plate
Water pressure	1-10bar (=10-100N/cm ² =0.1-1.0MPa)

Consumption values

The consumption values were obtained under standardised conditions. They can differ in household use.

Programme selector (Temperature)	Load size in kg ¹⁾	Water in litres	Energy in kWh
COTTONS/LINEN 95	6	62	2,20
ENERGY SAVING ²⁾	6	45	1,02
COTTONS/LINEN 40	6	58	0,70
EASY-CARES 40	3	58	0,52
DELICATES 30	3	58	0,42
WOOL/SILK  (Hand-washing) 30	2	54	0,35

1) The load size is determined in accordance with the EN 60456 standard loads.

2) **Note:** Programme settings for tests in accordance with or in support of EN 60 456 and IEC 60 456.

Consumption values will vary from those quoted depending on the pressure and hardness of the water and its initial temperature, the room temperature, type and quantity of washing, detergent used, fluctuations in mains voltage and options selected.

Installation and connection instructions



Safety information concerning installation

- This washing machine **cannot be built-in**.
- Before using for the first time, check the appliance for damage sustained while it was being transported. Do not under any circumstances connect an appliance that is damaged to the mains. In the event of damage to the appliance contact your supplier.
- Be sure to remove all the components of the transit packaging before using the appliance for the first time. Otherwise when spinning damage may be caused to the appliance or to neighbouring units or furniture.
- Before using the appliance for the first time, splash protection must be completed. (See "Removing transit packaging").
- Always plug the mains plug into a correctly installed shockproof socket.
- If hard-wired: hard-wiring to the mains may only be carried out by an a qualified electrician.
- Prior to using the appliance for the first time, ensure that the rated voltage and current on the rating plate match the mains voltage and current where the appliance is to be installed. The required fuse protection is also to be found on the rating plate.
- If work on the plumbing is required for the proper connection of the washing machine to the water supply, this must be undertaken by a registered plumber.
- If work on the electricity supply system is required for the proper connection of the washing machine to the electricity supply, this must be undertaken by a registered electrician.
- The washing machine's mains cable must only be replaced by a Service Force Engineer

Installing the appliance

Transporting the appliance



Warning: The washing machine is very heavy. There is a risk of injury. Exercise care when lifting the appliance.

- Do not lay the washing machine on its front nor on its right side (as seen from the front). Electrical components may get wet.
- Never transport the appliance without using the transit packaging. Only remove the transit packaging when the appliance is in its place of installation. Transporting the appliance without the use of the transit packaging can cause damage to the appliance.
- Never lift the appliance by the door when it is open nor by the plinth.

When using a sack trolley to transport the washing machine:

- Only use the sack trolley on the side of the appliance.

Removing the transit packaging

Important! Be sure to remove all the components of the transit packaging prior to using the appliance for the first time. Keep the transit packaging in a safe place, in case it is needed at a later date when the appliance is to be moved (e.g. moving house).

1. Open the two hose retainers located at the rear of the appliance and remove the hoses and electrical cable.

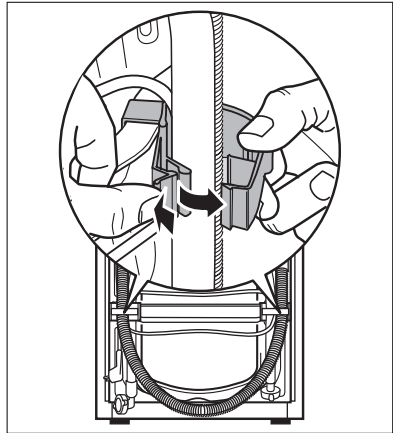

2. Remove the two hose retainers from the appliance with a strong tug.

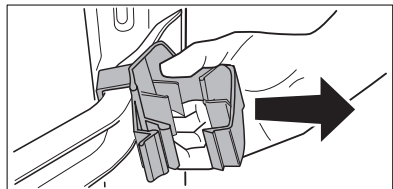

3. Remove both plastic caps sideways.

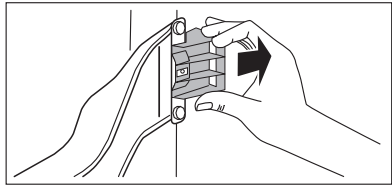

i Special spanner A and sealing caps B (2 units) and C (1 unit) come with the appliance.

4. Use special spanner A to remove screw D and the compression spring.

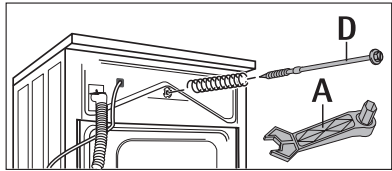

5. Turn sealing cap C upside down as shown in the illustration.

6. Use sealing cap C to cap the hole.

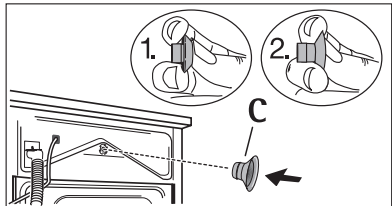

7. Use special spanner A to remove the two screws E.

8. Use special spanner A to remove the four screws F.

9. Remove transit bar G.

10. Screw in the four screws F again.

11. Use sealing caps B to cap the two large holes.

Important: Press all sealing caps B (2 items) and C (1 item) in firmly so that they snap into the rear wall.

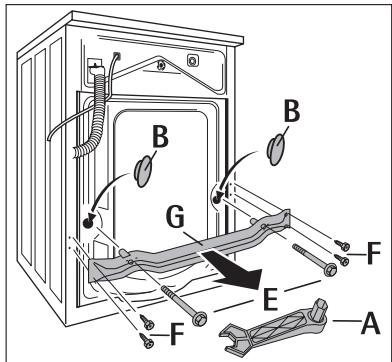

Where to install

Important! The washing machine must not be operated in a room where there is a danger of frost. There is a risk of frost damage or adverse effect on the performance of the machine. Frost damage is not covered under the warranty.

- The surface on which the appliance is to be installed must be firm and level. Do not install the appliance on carpeted floors or soft floor coverings.
- The surface on which the appliance is to be installed must be clean and dry and free from grease, so that the appliance does not slide.

- If the location in which the appliance is to be installed is fitted with small-format tiles, put a rubber mat (available in the shops) under the appliance.

If the appliance is to stand on a base:

In order for the appliance to be secure on the base, fixing plates*) must be mounted, into which the appliance is inserted.

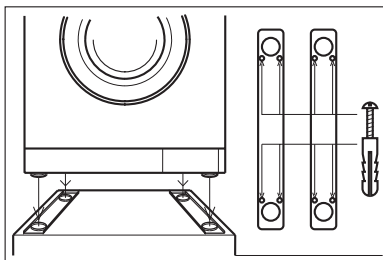

If the appliance is to stand on a floor which moves, e.g. a suspended wooden floor:

Place the appliance in an area as close as possible to a corner of the room.

Screw a water-resistant wooden board (at least 15 mm thick) onto at least 2 of the floor joists.

Making the appliance level

The four feet of the appliance are pre-adjusted.

Large degrees of unevenness can be compensated for by individually adjusting the height adjustable screw feet.

Use the special spanner supplied to do this.

Important! Do not use pieces of wood, cardboard or such like to level out unevenness in the floor, but adjust the height adjustable screw feet instead.

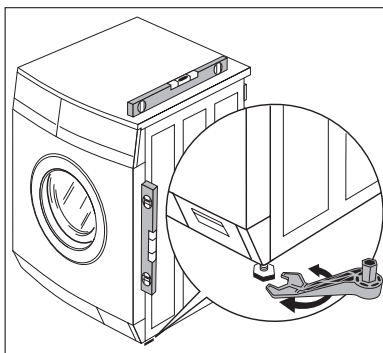

Electrical Connection

Any electrical work required to install this appliance should be carried out by a qualified electrician or competent person.



WARNING – THIS APPLIANCE MUST BE EARTHED.

The manufacturer declines any liability should these safety measures not be observed.

Before switching on, make sure the electricity supply voltage is the same as that indicated on the appliance rating plate.

The appliance is supplied with a 13 amp plug fitted. In the event of having to change the fuse in the plug supplied, a 13 amp ASTA approved (BS 1362) fuse must be used.

Should the plug need to be replaced for any reason, proceed as described below.

The wires in the mains lead are coloured in accordance with the following code:

Green and Yellow:	Earth
Blue:	Neutral
Brown:	Live

- The wire coloured green and yellow must be connected to the terminal marked with the letter "E" or by the earth symbol \oplus or coloured green and yellow.
- The wire coloured blue must be connected to the terminal "N" or coloured black.
- The wire coloured brown must be connected to the terminal marked "L" or coloured red.
- Upon completion there must be no cut, or stray strands of wire present and the cord clamp must be secure over the outer sheath.

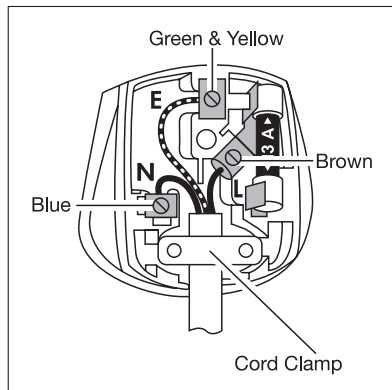

WARNING! A cut off plug inserted into a 13 amp socket is a serious safety (shock) hazard. Ensure that the cut off plug is disposed of safely.

Permanent Connection

In the case of a permanent connection it is necessary that you install a double pole switch between the appliance and the electricity supply (mains), with a minimum gap of 3 mm between the switch contacts and of a type suitable for the required load in compliance with the current electrical regulations.

The switch must not break the yellow and green earth cable at any point.

This appliance complies with the requirements laid out in the EEC Directive 76/899.

Voltage 240 V AC: Fuse rating 13 amps

See rating plate for further information.

This appliance meets VDE requirements.

Particular regulations of local electricity authorities must be observed.

This appliance conforms to EEC Directive No. 82/499/EEG on radio interference.



WARNING! Repairs to electrical appliances must only be carried out by trained personnel. Improper repairs may lead to serious risks for the user.

Connecting the appliance to the water supply

Important:

- This appliance must **not** be connected to the hot water supply.
- When connecting the appliance, use only new hose kits.
- Only connect the appliance to the drinking water supply. Rain water or water for industrial use may only be used if it fulfils the requirements of DIN 1986 and DIN 1988.
- Do not kink or crush the water inlet hose or drain hose.

Permitted water pressure

The water pressure must be at least 1 bar ($= 10 \text{ N/cm}^2 = 0.1 \text{ MPa}$), and may be a maximum of 10 bar ($= 100 \text{ N/cm}^2 = 1 \text{ MPa}$).

- If more than 10 bar: Connect a pressure reduction valve.
- If less than 1 bar: Disconnect the appliance end of the inlet hose from the solenoid inlet valve and remove the flow meter. (In addition remove the filter using pointed pliers and take out the rubber gasket behind it.) Replace the filter.

Water inlet

A 1.35m long pressure hose is supplied with the appliance.
If a longer inlet hose is required, only hoses from the manufacturer are to be used. Your local Service Force stocks hose kits of different lengths.



Sealing rings are either inserted in the plastic nuts of the threaded hose fitting or are included as spare parts. Do not use any other sealing rings.

Important! All threaded hose fittings must only be tightened by hand.

1. Connect the hose with the right-angle connector to the machine.

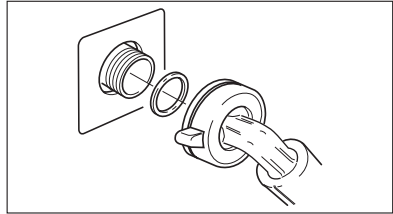

Important! Do not position the inlet hose vertically downwards. Position it to the right or the left as shown in the illustration.

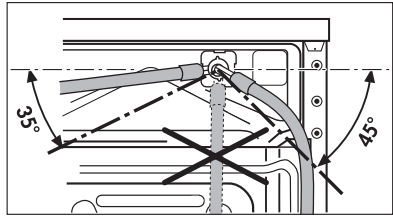

2. Connect the hose with the straight connector to a water tap with an R $\frac{3}{4}$ (inch) screw thread.
3. Slowly turn on the tap and check that all connections are watertight.

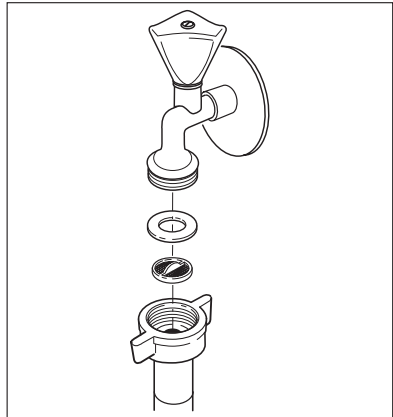

Water Drainage

The appliance drain hose should hook into a standpipe, the hook in the drain hose is formed using the plastic "U-Piece" supplied. The standpipe should have an internal diameter of approximately 38 mm (see diagram) thus ensuring there is an air break between the drain hose and standpipe.

Important! It is essential to lay the drainage hose without kinks.

When discharging into a standpipe ensure that the top of the curve in the hose end is no more than 90 cm (35.4") and no less than 60 cm (23.6") above floor level.

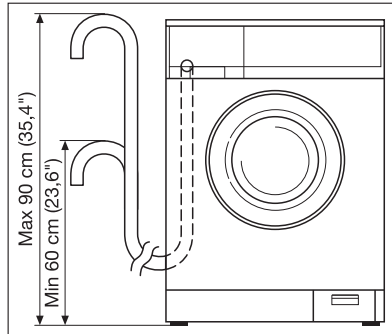

The upright standpipe should have a minimum length of 30 cm (12") from the bottom of the elbow to the top of the pipe (see diagram). Make sure that it is designed in such a way that the end of the drain hose cannot be covered with water.

Longer drain hoses are available in lengths of 2.7 and 4 metres from your Service Force Centre.

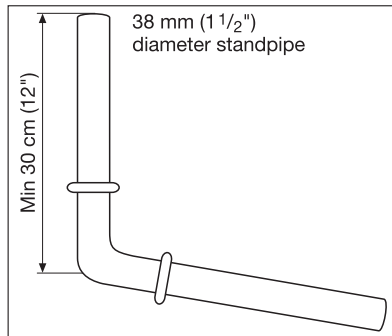

For drainage into an outlet

spigot: If the outlet spigot has not been used before, remove any blanking plug that may be in place. Push the drain hose onto the spigot and secure with a clip if required. Ensure the drain hose is looped upwards to prevent waste water from the sink entering the washing machine.

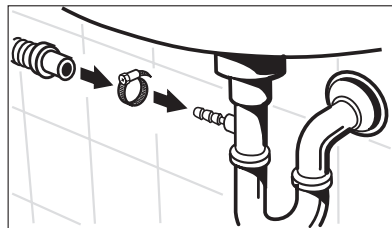

Important! The end of the drainage hose must not be submerged in the pumped-out water. Otherwise, the water could be sucked back into the appliance.

Pumping heights of over 1 metre

The washing machine's drain pump is able to pump water to a height of 1 metre, calculated from the surface on which the appliance is installed.

Important! If pumping height is over 1 metre malfunctions and damage to the appliance may arise.

For pumping heights over 1 metre a conversion kit can be obtained. Please contact Service Force Centre.

Warranty conditions

Great Britain

Standard guarantee conditions

We, AEG, undertake that if within 12 months of the date of the purchase this AEG appliance or any part thereof is proved to be defective by reason only of faulty workmanship or materials, we will, at our discretion repair or replace the same FREE OF CHARGE for labour, materials or carriage on condition that:

- The appliance has been correctly installed and used only on the electricity or gas supply stated on the rating plate.
- The appliance has been used for normal domestic purposes only, and in accordance with the manufacturer's operating and maintenance instructions.
- The appliance has not been serviced, maintained, repaired, taken apart or tampered with by any person not authorised by us.
- All service work under this guarantee must be undertaken by a Service Force Centre. Any appliance or defective part replaced shall become the Company's property.
- This guarantee is in addition to your statutory and other legal rights.
- Home visits are made between 8.30am and 5.30pm Monday to Friday. Visits may be available outside these hours in which case a premium will be charged.

Exclusions

This guarantee does not cover:

- Damage or calls resulting from transportation, improper use or neglect, the replacement of any light bulbs or removable parts of glass or plastic.
- Costs incurred for calls to put right an appliance which is improperly installed or calls to appliances outside the United Kingdom.
- Appliances found to be in use within a commercial environment, plus those which are subject to rental agreements.
- Products of AEG manufacture which are not marketed by AEG.

European Guarantee

If you should move to another country within Europe then your guarantee moves with you to your new home subject to the following qualifications:

- The guarantee starts from the date you first purchased your product.
- The guarantee is for the same period and to the same extent for labour and parts as exists in the new country of use for this brand or range of products.
- This guarantee relates to you and cannot be transferred to another user.
- Your new home is within the European Community (EC) or European Free Trade Area.
- The product is installed and used in accordance with our instructions and is only used domestically, i.e. a normal household.
- The product is installed taking into account regulations in your new country.

Before you move please contact your nearest Customer Care centre, listed below, to give them details of your new home. They will then ensure that the local Service Organisation is aware of your move and able to look after you and your appliances.

France	Senlis	+33 (0) 3 44 62 29 29
Germany	Nürnberg	+49 (0) 800 234 7378
Italy	Pordenone	+39 (0) 800 117511
Sweden	Stockholm	+46 (0) 8 672 5360
UK	Luton	+44 (0) 8705 350 350

Weitere Kundendienststellen im Ausland

In diesen Ländern gelten die Garantiebedingungen der örtlichen Partner. Diese können dort eingesehen werden.

Further after-sales service agencies overseas

In these countries our AEG-Electrolux agents' own guarantee conditions are applicable. Please obtain further details direct.

Autres agences étrangères assurant le service après-vente

Dans ces pays, les conditions de garantie des concessionnaires de la région sont valables. Vous pouvez les consulter sur place.

Otros puntos de Postventa en el extranjero

En estos países rigen las condiciones de nuestros representantes locales, las cuales pueden ser consultadas allí mismo.

Ulteriori uffici del servizio tecnico assistenza clienti all'estero

In questi paesi sono valide le condizioni di garanzia dei partner locali. Queste condizioni possono essere esaminate sul luogo.

Serviços de assistência técnica no estrangeiro

Nestes países são válidas as condições de garantia dos concessionários locais, podendo aí ser consultadas.

További vevőszolgálati irodák külföldön

Ezekben az országokban a mi AEG-Electrolux vevőszolgálatainknál saját jótállási feltételek alkalmazhatók. A további adatokat kérjük közvetlenül szerezzék be.

Servisne službe

Na garancijskem listu boste našli seznam pooblaščenih servisnih služb AEG-Electrolux.

Customer Service Centres

<p>U.A.E. Abu Dhabi Universal Trading Company P.O. Box 43 99 Tel.: 6335331 Service Center 6733974</p>	<p>Jordan Jordan Household Supply Co. Ltd. P.O. Box 3/68 Amman/Tel.: 69 70 50</p>	<p>Malta ITC International Trading Company White House Building Mountbatte Street Blata L-Bajda/Tel.: 220644</p>
<p>Egypt Middle East Commercial Center 4 Salah El Dein St. - 2nd floor Heliopolis, Kairo Egypt Tel.: 2024181719</p>	<p>Canada EURO-LINE Appliances 2150 Winston PARK Drive 20 Oakville, Ontario L6H 5V1 Tel.: 905 829 3980 Fax: 905 829 3985</p>	<p>Mauritius Happy World Centre Ltd. P.O. 7 54 1 Chausee Street Port Louis Tel.: 25355</p>
<p>Australia The Andi-Co Group 1 Stamford Road Oakleigh VIC 3166 Tel.: (03) 9569 1255 Fax: (03) 9569 1450 www.andico.com.au</p>	<p>Korea (South) Core Incorp. 3/F Chewoo Bldg. 200 Nonhyun-Dong Kangnam-Ku 135-010 Seoul Telefon 82 2 549 89 61</p>	<p>Namibia AEG NAMIBIA (PTY) LIMITED-Jeppe Street Northern Industrial Area Windhoek Tel.: (061) 21-6082/4 Fax: (061) 217838</p>
<p>Bahrain/Arabian Gulf A.A. Zayani & Sons P.O. Box 9 32 Bahrain Tel.: 17311124</p>	<p>Croatia Electrolux D.O.O. Suplova 7 10000 Zagreb Tel.: 1 61 19512 Fax: 1 61 19513</p>	<p>New Zealand Monaco Corporation Ltd. 10 Rothwell Avenue Albany - Auckland 4399 Auckland 1 New Zealand Tel.: 00 64-92 59 11 11 Fax: 00 64-92 59 11 12</p>
<p>Bulgaria Electrolux Bulgaria E.O.O.D. 91 Levski Blvd. 1000 Sofia Tel.: 2 806676 Fax. 2 980 5276</p>	<p>Kuwait/Arabian Gulf Ali Al-Ghanim Est. P.O. Box 21540 - Safat Tel.: 4822190 Fax: 4820116</p>	<p>Syria WATTAR CO. P.O. Box 36109 Mazzeh - Damascus Direct Phone: 00963116132649 Fax: 00963116119537</p>
<p>Cyprus Hadjikyrlakos & Sons Ltd. Prodromou 121 P.O. Box 21587 Nicosia 1511 Service Telephones: Nicosia 02 481226 Limassol 05 562182 Larnaca 04 633929 Paphos 06 932 699</p>	<p>Lebanon Adib & Assaferi P.O. Box 539 Tripoli</p>	<p>Iran ARIAN International Develop- ment Co. AEG Showroom Shariati, Balatar as Safar Teheran / Iran Phone No. Showroom: 021 / 285 513 / 4 Phone No. Service: 021 / 312 27 67 / 8</p>
<p>Estonia Electrolux Estonia Ltd. Mustamäe tee 24 EE0006 Tallinn Tel.: (372) 6 650 090 Fax: (372) 6 650 092</p>	<p>Latvia Electrolux Latvija Ltd. Kr.Barona iela 130/2 Riga, LV-1012 Tel.: 371 7313626 Fax: 371 7845954</p>	<p>Poland Electrolux Poland Sp. zo.o. ul. Domaniewska 41 02-034 Warszawa tel.: 022 874 33 33 fax: 022 874 33 00</p>

<p>Hong Kong Dah Chong Hong Ltd. 20 Kai Cheung Road Kowloon Bay Kowloon – Hong Kong Tel.: 0085222621620 Fax: 0085227550333</p>	<p>Lithuania Electrolux Lithuania Verkui 29 2600 Vilnus Tel.: 372 272 3326 Fax: 372 272 3366</p>	<p>Russia Electrolux Russia Ltd. 16 Olympiysky prospekt 129090 Moscow Tel.: (095) 937 7837 Fax: (095) 926 5513</p>
<p>Israel Evis Ltd. Tadiran-Ampa Service 10 Gibonay Israel Street New Industrial Zone Netanya, 42504 Israel</p>	<p>Malaysia Arzbergh Engineering No. 49A/B, Jalan Petaling Utama 7 4600 Petaling Jaya Tel.: 3 795 1084 Fax: 3 795 1082</p>	<p>Saudi Arabia Awad Badi Nahas Est Shara Siteen Jeddah 21463 Phone: 6646583 Alia Trading Co Mecca Road Riyadh 11491 Phone 4645977</p>
<p>Japan Electrolux Japan Ltd. Domestic Appliances Department Maruzen Showa Warehouse Building Tookai 4-5-12, Ota-ku 143-006 Tokyo Tel.: 0120-13-7117 Fax: 03-3790-5257</p>	<p>Singapore Group Pte Ltd. 833 Bukit Timah Road Unit no. 01-11 Royalville 279887 Singapore Tel.: 0065 64638484 Fax: 0065 64638488</p>	<p>Slovenia Electrolux Slovenia D.O.O. Traska Ul. 132 1000 Ljubljana Tel.: 61 1234 137 Fax: 61 1234 238</p>
<p>Thailand Olympia Thai Tower, 444 Rachadapiser Road Samsennok- Huaykwang 10320 Bangkok Thailand Tel.: 006625136111 Fax: 006625136334</p>	<p>Slovakia Rep. Electrolux Slovakia S.R.O. Seberiniho 1 821 03 Bratislava Tel.: 02 4333 4322, 4355 Fax: 02 4333 6976</p>	<p>South Africa AEG (Pty) Ltd. 55, 12th Road P.O. Box 1 02 64 Kew/Johannesburg 2000 Tel.: 8069111</p>
<p>Hungary Electrolux Lehel KFT Erzsébet Királyné útja 87. 1142 Budapest Tel.: 00361/467-3200</p>	<p>Czech Rep. ELECTROLUX DOMÁCÍ SPOTŘEBIČE CZ DIVIZE ELECTROLUX S.R.O. Customer Centre Hanusova ul. 140 21 Praha 4 Tel.: 2 6112 6112 Telefax: 2 6112 3504</p>	

Service and Spare Parts

If the event of your appliance requiring service, or if you wish to purchase spare parts, please contact Service Force by telephoning:

0870 5 929 929

Your telephone call will be automatically routed to the Service Force Centre covering your post code area.

For the address of your local Service Force Centre and further information about Service Force, please visit the website at

www.serviceforce.co.uk

Before calling out an engineer, please ensure you have read the details under the heading „What to do if...“

When you contact the Service Force Centre you will need to give the following details:

1. Your name, address and post code.
2. Your telephone number.
3. Clear and concise details of the fault.
4. The model and serial number of the appliance (found on the rating plate)
5. The purchase date.

Please note that a valid purchase receipt or guarantee documentation is required for in-guarantee service calls.

Customer Care

For general enquiries concerning your AEG appliance, or for further information on AEG products please contact our Customer Care Department by letter or telephone at the address below or visit our website at **www.aeg.co.uk**.

Customer Care Department
Major Appliances
AEG Domestic Appliances
Addington Way
Luton
Bedfordshire, LU4 9QQ
Tel: 08705 350350 (*)

For Customer Service in the Republic of Ireland please contact us at the address below:
AEG/ Electrolux Group (Ire) Ltd
Long Mile Road/ Dublin 12
Republic of Ireland
Tel: +353 (0) 1 4090754
Email: service.eid@electrolux.ie

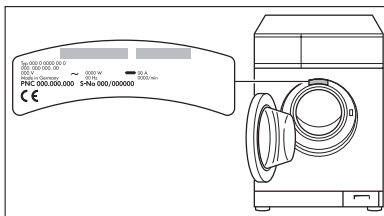

(*) Calls may be recorded for training purposes

 **From the Electrolux Group. The world's No. 1 choice.**

The Electrolux Group is the world's largest producer of powered appliances for kitchen, cleaning and outdoor use. More than 55 million Electrolux Group products (such as refrigerators, cookers, washing machines, vacuum cleaners, chain saws and lawn mowers) are sold each year to a value of approx. USD 14 billion in more than 150 countries around the world.

AEG Hausgeräte GmbH
Postfach 1036
D-90327 Nürnberg

<http://www.aeg-electrolux.de>

© Copyright by AEG

105 176 611-00-150905-02

Subject to change without notice