

LAVAMAT 2004

Combined Washing Machine
and Tumble Dryer
Lavamat 2004

AEG

Your new Lavamat is a modern fully automatic washing machine and tumble dryer. With a little care and attention, it will give you many years of faithful service.

Please read this instruction booklet carefully before starting to use your

machine. This will help you to get to know your machine and how to make the best use of all the valuable features. Information on installation and connection can be found on pages 26—31.

Your Lavamat 2004	3
Preparing the machine for use	4
Explanation of controls	5—9
Sorting the Laundry	
— International Textile Care Labelling Code	10
— Hints on stain removal	11
Load sizes	12
Washing powder, conditioner and starch	13—14
Check list — before selecting a programme	15
Wash programmes	16—17
Tumble drying	19—21
If you think your machine is not working properly	22—23
Care and maintenance	24—25
How to remove the transit bars	26
Installation and Connection	27—30
How to build in your Lavamat into a fitted kitchen	31

Combined Washing Machine
and Tumble Dryer Lavamat 2004
E. No: 605 105 901
1100/800/500 r.p.m.

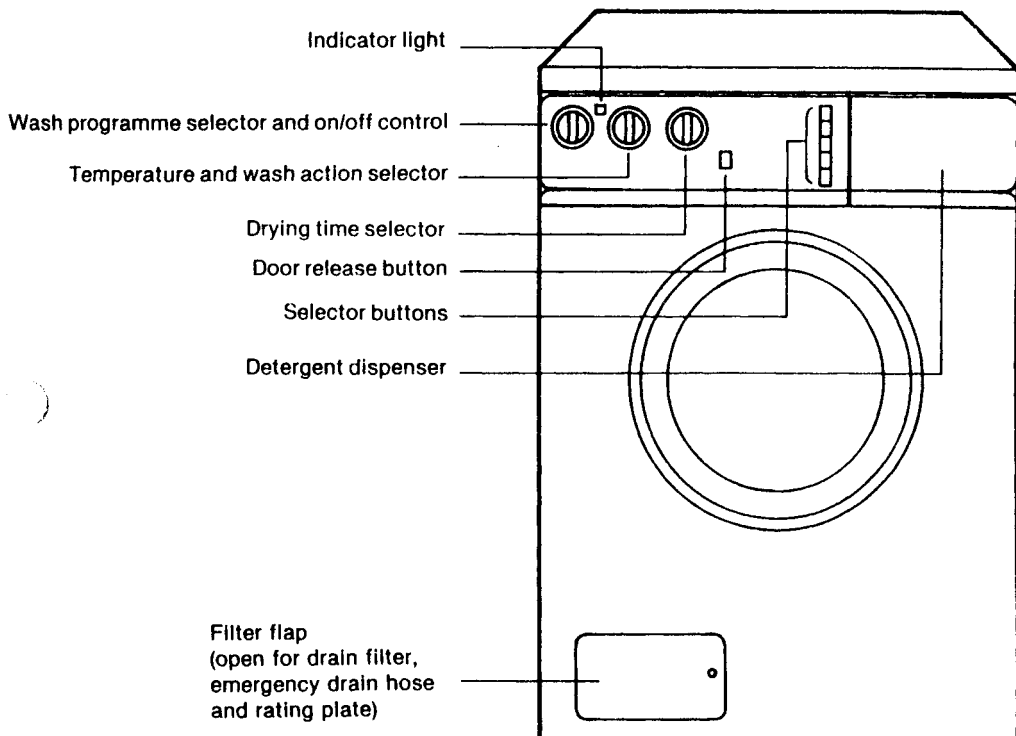

Preparing the machine for use

Transit bars

To avoid damage during transit we have fitted transit bars. Please remove these before installing and connecting the machine. (See details on page 26) Please keep these transit bars, for use when moving house.

Installation

The Lavamat is easy to install and connect. Please follow the instructions given on page 27—30 and make sure that you comply with any regulations of your local Water Board and Electricity Board. If in doubt consult a specialist.

Prime the machine

To do this let the machine complete a 95 °C cotton and linen wash cycle without clothes adding 1 to 2 cups of washing powder to compartment 2 (II). See »Programme Guide« pages 16—17)

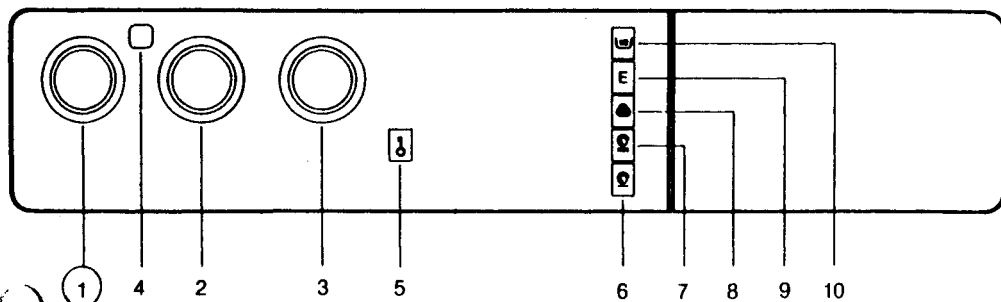

1 Wash programme selector and on/off control

Besides the off position »0« the programme selector has 5 settings for the basic programmes and the additional programmes. These are:

- 1 Wash programme with pre-wash**
 - 2 Wash programme without pre-wash**
 - 3 Short programme without pre-wash**
 - 4 Soft rinsing - mild starching - spinning or soft rinsing - mild starching only**
 - 5 Pumping with and without spinning**
- With the exception of woollens you can wash all fabrics with or without pre-wash depending on the degree of soiling.

The wash programme selector should only be turned clockwise and when the machine is switched off. Pull out the wash programme selector to start the programme. The wash programme selector will start to turn indicating the progress of the programme. To switch the machine off, push in the wash programme selector.

Important

The wash programme selector can only be turned clockwise and when the machine is switched off. It can only be pulled out in the „0“ position or on the programme number selected. It can be pushed in at any stage during a cycle to switch the machine off.

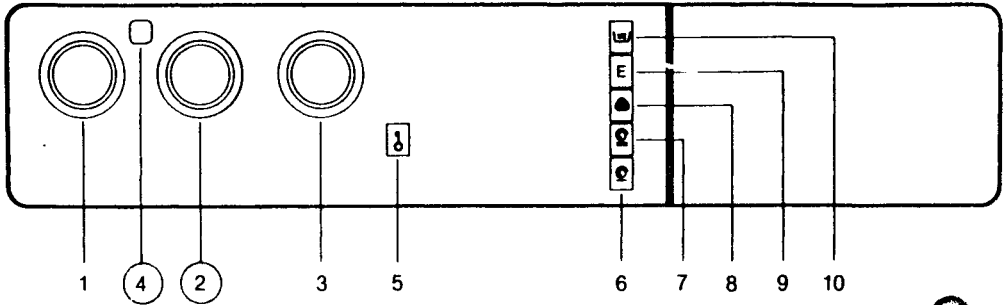

4 Indicator light

This will come on when the wash programme selector (1) is pulled out. It will go out when the machine is

switched off or the door of the machine is opened.

2 Temperature and wash action selector

This selector enables you to choose a temperature between 30 °C and 95 °C. Please follow the manufacturer's washing instructions or the International Textile Care Labelling Code on the laundry care labels.

By pulling out or pushing in this selector you can choose the correct wash action for your laundry.

Selector pushed in —



for easy-care fabrics, delicate synthetics and woollens

The programme cycle is as follows:

- high water level wash with
- reduced drum action
- 3 rinses
- laundry is left in the last rinse water (rinse water stop)

Selector pulled out —



for cottons and lines: whites and coloureds

The programme cycle is as follows:

- normal water level wash with
- normal drum action
- five rinses
- Variomatic spinning 1100 r.p.m.

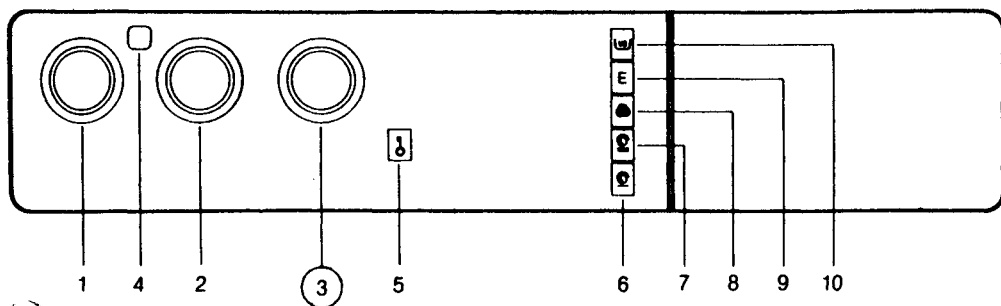

3 Drying time selector

The timer is used to select the required drying time. It rotates during operation indicating the remaining drying time.

The timer should only be turned clockwise. For further details on drying see page 19.

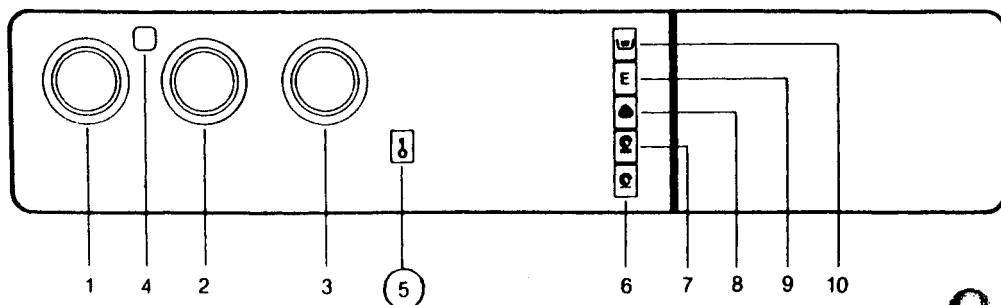

5 Door release button

To open the door:

- set the wash programme selector (1) to the »●« position, pull out and press the door release button.
- after a programme with rinse water stop, push in the wash programme selector (1), turn to programme 5, pull out the selector and wait until it has returned to the »●« position.
- after a programme with spinning wait until the automatic safety lock has been released (approx 1 minute after the end of the spin cycle).

To open the door during a power cut:

- Unplug the machine and wait until the drum has stopped rotating
- Drain off any wash or rinse water through the emergency drain hose at the drain filter (see page 24 under »Drain filter«)
- Pull cord on the left of the filter flap down by approx. 1 cm (see page 26).

Important

The door must not be opened while the drum is still rotating or if there is water in the drum.

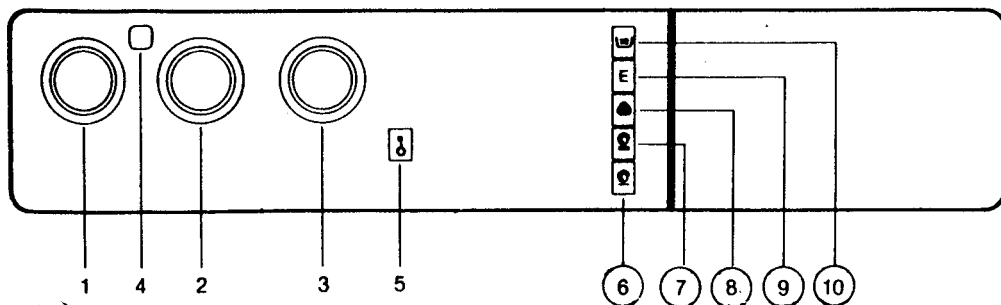

6 Variomatic-Spinning button

Press this button in addition to a selected programme if you wish to reduce the spin speed from 1100

r.p.m. to approx. 800 r.p.m. This also reduces the final spinning phase from 6 to approx. 1.5 minutes.



7 Short spin button

Press this button in addition to a selected programme for a very short

(approx. 15 sec) and very gentle (approx. 500 r.p.m.) spin.



**8 Button
woollens**

Press this button in addition to the selected programme when washing

machine washable woollens. This ensures an extra gentle wash action.



9 Energy saving button

Press this button in addition to the selected programme if you want to wash lightly to normally soiled cottons and linens (normally washed at 95 °C) at a temperature of 60 °C.

The energy saving button prolongs the wash time to give a good wash result and you save approx. 30% energy by not using a 95 °C programme.



10 Half load button

Press this button in addition to a selected programme if you want to wash smaller loads. Cottons and linens: approx: 2.5 kg dry laundry, easy-care fabrics and delicate synthetics 0.8 kg dry laundry. **Do not press this button when washing woollens.**

Although the half load button is very valuable for the smaller loads we would like to point out the most economical wash is still the full capacity one.

Sorting the laundry

Check the manufacturer's instructions or the care label inside each garment. The laundry should be sorted into: Cottons and linens (whites and coloureds)

Easy-care**Delicate synthetics****Woolens**

For more details see page 12 and following pages.

Practical Hints

⊠ Do not mix whites and coloureds as the whites will become grey.
 ⊠ New items tend to lose some of their colour when washed for the first time. It is therefore advisable to wash them separately the first time.
 ⊠ Woollen items which carry the wool symbol must also bear the description »machine washable«. Woollen items which only bear the wool symbol cannot be washed in washing machines.

⊠ Make sure that no metal items (e.g. paperclips, safety pins, pins) are left in the laundry. Fasten buttons, zips, hooks and eyes, tie loose belts long apron strings etc.
 ⊠ Remove stubborn stains prior to washing (see also next page).
 ⊠ Synthetic curtains should be handled carefully as they snag easily. Remove the hooks or rollers and place the curtains in a pillowcase or wash-bag, to wash. We accept no responsibility for any damage to curtaining.

The International Textile Care Labelling Code

Symbol	Fabric
	White cotton and linen articles without special finishes
	Cotton, linen or rayon articles without special finishes where colours are fast at 60 °C
	White nylon; white polyester/cotton mixtures
	Coloured nylon; polyester; cotton and rayon articles with special finishes; acrylic/cotton mixtures; coloured polyester/cotton
	Cotton, linen or rayon articles colours are fast at 40 °C but not at 60 °C
	Acetate and triacetate, including mixtures with wool; polyester/wool blends
	Wool, including blankets and wool mixtures with cotton or rayon; silk
	Silk and printed acetate fabrics with colours not fast at 40 °C
	Cotton articles with special finishes capable of being boiled but requiring drip-drying
	Do not machine wash
	Do not wash

Ironing

This symbol is used to provide ironing instructions. The number of dots within the symbol is varied to indicate the correct temperature setting, as follows:



One dot = cool



Two dots = warm



Three dots = hot



Crossed out = do not iron

Dry cleaning

A circle is the symbol used for dry-cleaning instructions. It will never appear on its own but will have additional information as follows:



Articles normal for dry-cleaning in all solvents.



Articles normal for dry-cleaning in perchlorethylene, white spirit, Solvent 113 and Solvent 11.



Articles normal for dry-cleaning in white spirit or Solvent 113.



Do not dry-clean.

Important

If possible remove stains immediately with lukewarm water and soap. Stains which have been left are more difficult to remove. Use a clean, absorbent cloth. Do not rub but dab the stain. Bleaching agents and many stain removers are particularly harsh- therefore try them out first where an adverse affect is least likely to be seen (hem, inside seam)

- Do not use stain remover in the washing machine.
- Do not inhale solvents. They can damage your health.
- Take care when handling inflammable stain removers.
- Keep stain removers out of the reach of children (They may be poisonous).

Oil stains

Wash with soap and cold water.

Ink, felt-tip and ball-point pen stains

Methylated spirits

Grease

Propriety grease solvent

Grass

Methylated spirits

Coffee, tea, cocoa fruit and red wine

Treat white or colour-fast cottons with chloride bleach. Faint stains come out when washed.

Adhesive (Uhu)

Amylacetate

Grease-up

Remove the grease with propriety grease solvent.

Mould spots

Mould spots come out in the wash. Treat remaining stubborn stains with diluted chloride bleach for white cottons and linens and Hydrogen Peroxide for other white fabrics.

Tar

Propriety grease solvent, scrape off surplus, soften with butter, and wipe off. Apply solvent and wash immediately.

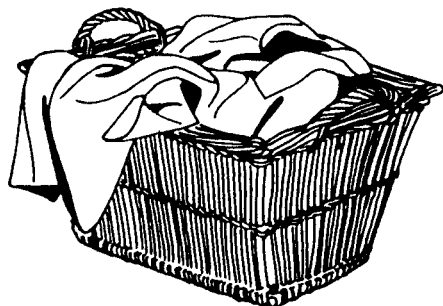

Type of laundry	Full load	Half load
Whites and coloureds lightly soiled	up to 5 kg dry laundry	up to 2.5 kg dry laundry
Whites and coloureds normally soiled	up to 4.5 kg dry laundry	up to 2.5 kg dry laundry
Whites and coloureds heavily soiled	up to 3.5 kg dry laundry	up to 2.5 kg dry laundry
Easy-care and delicate synthetics	up to 1.5 kg dry laundry which equals approx. 6 to 8 shirts, or a curtain of approx 2.5x5 m	up to 0.8 kg dry laundry
Woollens	up to 1 kg dry laundry	

Tip

If there is too little laundry in the drum (e.g. just one dressing gown), this may cause vibration and instability of the machine. We therefore recommend that you add more items.

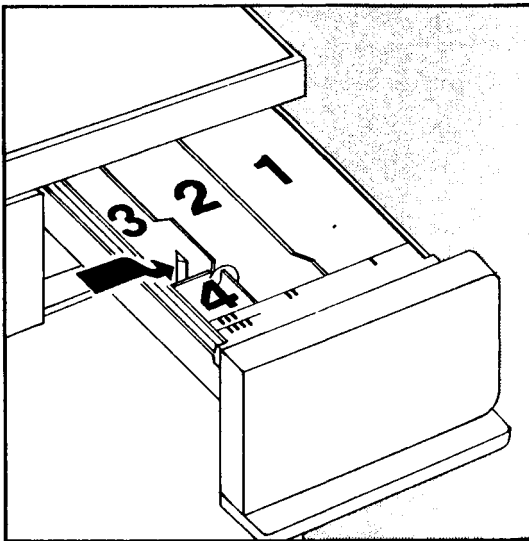

Before selecting a programme, pour washing powder and fabric conditioner into the relevant compartments of the dispenser.

To do this pull open the dispenser drawer.

You will find 4 compartments as illustrated above.

Add washing powder for:

the pre-wash

to compartment 1 (I) on the right

the main wash

to compartment 2 (II) centre

add fabric

to compartment 3 (III) on the left

conditioner

(do not fill above the indicator-see arrow)

add liquid starch

to compartments 3 and 4 (III + IIII) on the left

(fill to indicator level in compartment 3

and up to 5mm below the top in compartment 4)

Carefully close the drawer. If the drawer is not pushed back completely the machine will not take in any water.

To use the washing powder and the conditioner in the most effective way they are fed into the machine approx 1.5 minutes after the programme has started.

Practical Hints

In an automatic washing machine you need to use a low lather washing powder. We recommend Persil automatic which has been specially formulated for automatics.

To soft-rinse or starch laundry be sure to use liquid fabric conditioner or starch. If, however, you wish to use

powder starch, then dissolve the starch according to the manufacturer's instructions and pour the dissolved starch straight into the drum after the wash programme has finished and select the separate starching programme.

Practical Hints

How much washing powder you use depends on the water hardness (soft, medium, hard, very hard), the quantity of laundry and the degree of soiling. Your local Water Board will advise you on the hardness of the water in your area. On the washing powder packet you will find instructions as to how much powder to use (according to water hardness).

If a measuring beaker is supplied with the washing powder do not fill above the indicator level. If too much powder is used, excessive foaming may occur. This interferes with the movement of the laundry in the drum resulting in a poor wash performance.

When washing a small quantity of laundry (programmes with ) reduce the amount of powder suggested on the powder packet by 30%.

Spinning

The machine has 3 spin programmes:

Button

Short spin 500 r.p.m.
for delicate synthetics
(e.g. net curtains)

— 15 second spin

Button

Variomatic spin 800 r.p.m.
for woollens, wool mixtures,
easy-care fabrics and synthetics.

— final spin phase
reduced to 1.5 minutes

Variomatic spin 1100 r.p.m.
for cottons and linens

— final spin phase
6 minutes

Note:



Increased motor noise for approx.
3.5 seconds before the final spin
phase.

If the machine is not permanently plumbed-in

1. Plug in the machine and switch on at the power socket.
2. Make sure that the drain is not kinked and is securely hooked over the sink edge. If the sink edge is too wide to hold the



3. Connect the water inlet hose to the tap.
hose, use the hose holder provided. (For further details see page 28).

Before you select a programme

1. Open the water tap.
2. Open the door (pull out wash programme selector (1)  and press door release button ). Push in the wash programme selector.
3. Distribute the laundry in the drum as loosely as possible.
4. Close the door.
5. Pull open the powder dispenser and pour washing powder into compartments 1 and/or 2, fabric

6. Select wash action and temperature (2). Select wash programme on the wash programme selector (1) and pull out  to start the programme. The powder is fed into the machine 1.5 minutes after the start of the programme.
conditioner into 3 or starch into 3 and 4. Close the dispenser carefully. If it is not closed completely, the machine will not fill with water.



End of programme

- The wash programme selector stops
- In the »0« position after a programme with spinning
 - just before »5« after a programme with rinse water stop. To pump out the water push in the programme selector (1)  turn to »5« and pull out  to start the machine. If you wish to spin the laundry, select the





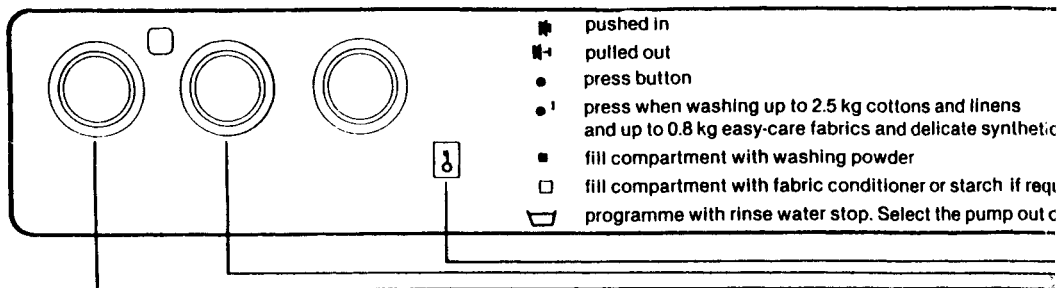

- spin required as per »Programme Guide« on page 16.
Open the door.
Remove the laundry from the drum. Return any controls to the »Off« position.
Turn off the water tap if all the washing and drying is finished. Switch off at the power socket and remove the plug.

General for programmes

- Washing powder: compartments 1 and 2
 with pre-wash: compartment 2
 without pre-wash: compartment 3
 Fabric conditioner: compartment 3
 Liquid starch: compartments 3 and 4
 (up to 5 mm below the top of compartment 4)

Programme selection:
 Turn the wash programme selector (1) when the machine is switched off  to the required programme 1 - 5, then pull selector  to start the programme.



Door release		
Cottons und linens, Whites	with pre-wash	bed linen, towels, table linen, underwear, shirts etc with care label 
	without pre-wash	
Cottons and linens, whites energy saving	with pre-wash	bed linen, towels, table linen, underwear, shirts etc, lightly to normally soil care label
	without pre-wash	
Cottons and linens, coloureds	with pre-wash	Coloured bed linen, towels, table linen, unde shirts etc, with care labels
	without pre-wash	
Easy-care fabrics and delicate synthetics 	with pre-wash	Cottons with special finishes, Cotton mixtures, synthetics etc, with care labels  
	without pre-wash	
Short programme for cottons and linens	without pre-wash	For very lightly soiled clothes, e.g. swim wear, tennis clothes etc.
Short programme for easy-care fabrics and delicate synthetics 	without pre-wash	
Woollens 		Machine washable wool and wool mixtures with care label 
soft rinsing, starching	without spinning	
	with spinning 500 r.p.m.	
	with spinning 800 r.p.m.	
	with spinning 1100 r.p.m.	
Pump out		
Spinning	500 r.p.m. (short)	Delicate synthetics
	800 r.p.m. (Variomatic)	Easy-care fabrics, synthetics and woollens.
	1100 r.p.m. (Variomatic)	Cottons and linens.

**Spinning
before
tumble drying**

Drying times depend on the amount of water extracted during spinning. Be sure to select the correct spin for the different fabrics.

Important:

Make sure that the laundry is distributed loosely in the drum before selecting tumble drying to avoid heat damage to the laundry.

**Sorting the
laundry**

Different fabrics require different drying times.

Sort the laundry into:

- Cottons - linens
- easy-care fabrics and synthetics

The majority of textile articles can be tumble dried but check the care labels for the following symbols which are now widely used:



tumble drying beneficial



do not tumble dry

Load sizes: 2.25 kg cottons and linens
1.5 kg easy-care fabrics
or synthetics

Do not tumble dry:

Textile articles which have been treated with inflammable liquids. Only dry articles which have been cleaned with water solutions.

Articles containing plastic foam or rubber-like materials.

Very large table cloths, heavy bed spreads or similar bulky articles.

Dripping wet laundry.

Woolens. these should be dried flat.

Acrylics

Important

The washer-drier operates on the condensation principle. For this reason, when drying takes place, the water tap must be open and the drain must lead into a wash basin or similar vessel. In the same way, the dispenser drawer must be fully closed.

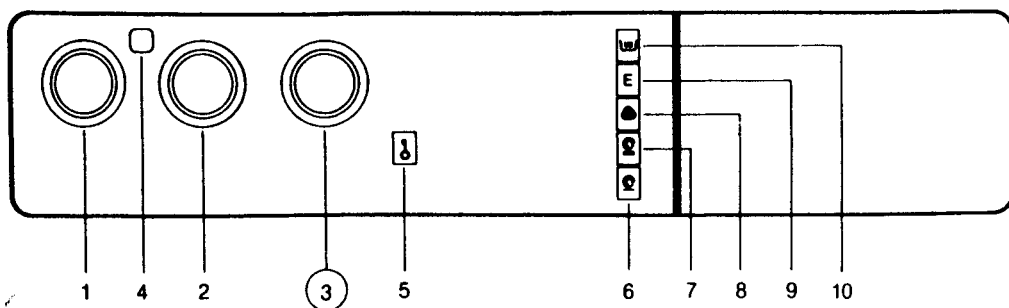

3 Drying time selector

The drying time is variable between 20 and 180 minutes

Important!

The timer should only be turned clockwise.

When the machine is switched on (pull out the wash programme selector (1)) the progress of the drying

programme is indicated by the turning of the drying time selector. The laundry is cooled during the last 20 minutes. The programme is completed when the drying time selector has returned to the »0« position.

During the first drying programme

The protective coating on the heating element and on the outside of the drum will evaporate resulting in a slight smell for a short period of time.

Do not stop the machine during drying

To avoid damage to the laundry in the drum do not switch the machine off during the drying programme or the cooling down period. Should you need to interrupt the drying programme, advance the timer to the last twenty minutes and let the machine complete

the cooling down cycle. This will prevent the laundry from possible damage by the stationary and hot drum. If it is necessary to remove the laundry prematurely, for example in the case of power failure, press the door release button and remove the laundry immediately.

Drying several different loads

Start with synthetics and easy-care fabrics, followed by cottons and linens.

After the drying programme

If you have dried fluffy articles, select a rinse programme to remove any fluff from the drum.

- Push in wash programme selector (1), turn to »4« and pull out.

- To pump out the water, push in the wash programme selector (1) turn to »5« and pull out. Check the drain filter after each drying programme and clean the filter if necessary.

Cottons,
linens

Before tumble drying:
Variomatic spln 1100 r.p.m.

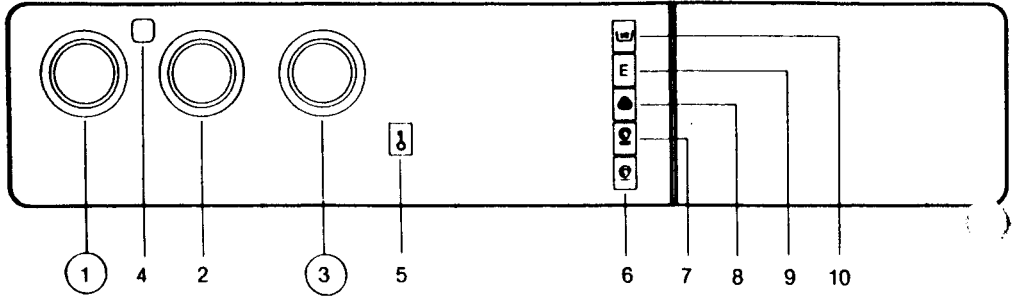

Using the
dryer

- Hook the drain hose over the sink edge, connect the inlet hose to the water tap and turn on the tap.
- Distribute laundry loosely in the drum and close the door.
- Set the timer (3) to the required drying time (see guidelines below)
- Pull out the wash programme selector (1) to start the programme.

The programme is completed when the timer has returned to the »0« position.

- Press door release button and remove the laundry
Switch off the machine (push in the wash programme selector) and turn off the water tap.
- Switch off at the power socket and remove the plug.

Weight dry laundry		0.5 kg	1.0 kg	1.5 kg	2.0 kg	2.2 kg
Storage dry	1. load	65 min	80 min	110 min	130 min	140 min
	2. load	55 min	70 min	100 min	115 min	125 min
Ironing damp	1. load	55 min	65 min	80 min	100 min	110 min
	2. load	50 min	60 min	75 min	95 min	105 min

Easy-care fabrics, synthetics

Before tumble drying:
Variomatic Spin 800 r.p.m.

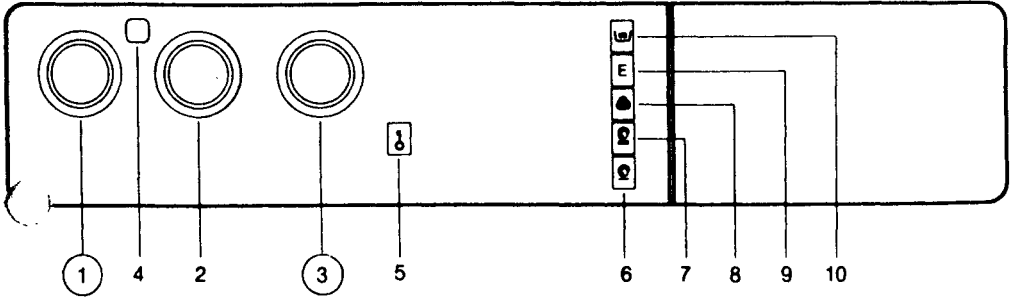

Using the dryer

- Hook the drain hose over the sink edge, connect the inlet hose to the water tap and turn on the tap.
- Distribute laundry loosely in the drum and close the door.
- Set the timer (3) to the required drying time (see guidelines below).
Do not overdry synthetics and remove the laundry as soon as the drum has stopped to minimise creasing. Static electricity tends to build up on synthetics causing »crackling« and »clinging«. To avoid this use

fabric conditioner in the final rinse of the wash. Pull out the wash programme selector (1) to start the programme. The programme is completed when the timer has returned to the »●« position. Press door release button and remove the laundry. Switch off the machine (push in the wash programme selector) and turn off the water tap. Switch off at the power socket and remove the plug.

Weight dry laundry	0.5 kg	1.0 kg	1.5 kg
---------------------------	--------	--------	--------

Easy-care fabrics and synthetics	45 min	55 min	75 min
---	--------	--------	--------

If you think your machine is not working properly

Non functioning of your Washer/Dryer is mostly due to minor causes which you can rectify yourself.

Before you call out a service engineer please check through the fault finding chart below.

The Programme does not start

- Is the machine plugged in?
- Are the fuses in working order?
- Have you closed the powder drawer properly?
- Check that the machine door is fully closed.
- Have you pulled out the wash programme selector?
- Have you turned on the water tap?

- Is the filter in the water inlet hose blocked?
The filter is located where the hose attaches to the rear of the machine. Unscrew the hose and clean the filter under running water. (see page 25)

Water is not pumped off completely

- Is the water drain hose kinked or twisted? In this case the drain pump cannot pump off sufficient water.

- Is the drain filter or Is the emergency drain hose blocked?

Incoming water is drained off immediately

- Have you secured the drain hose properly? Please make sure that the end of the drain hose is not

submerged in water otherwise the incoming water is drained off by suction.

The washer/dryer does not spin

- Is the drain filter blocked?

The machine is oversudsing

- Have you used too much washing powder? Use less powder for the next wash or omit the pre-wash.

- Have you used a low lather powder?

The machine vibrates or moves

- If there is too little laundry in the drum (e.g. just one dressing gown, bath mat etc) this may lead to vibration. Therefore, wash more items. However, movement may also result from:
 - Blocked drain filter.
 - Kinked or twisted drain hose.
 - Transit bars have not been removed.
 - The machine is not installed properly (see page 29)

Rust spots in the drum

- The drum of your machine is made of stainless steel and cannot rust. However, rust may be introduced with the laundry (zips, paper-clips, hair pins, tacking or safety pins). Remove such stains with a stainless steel cleaner. Do not use any abrasives!

Please use this fault-finding chart as a check list for the proper performance of your machine. If you call a service engineer in connection with one of the aforementioned problems, please note that the cost involved in this call will have to be passed on even during the warranty period. Should you be unable to locate the cause of the problem in spite of this check list, then please contact your AEG Service Department.

If you require to have your LAVAMAT serviced, you will be asked for the E-No. of your machine which you will find on page 3 of this booklet or on the rating plate on your machine.

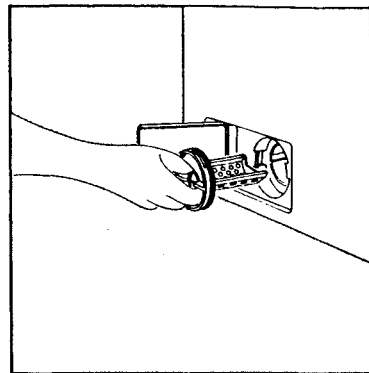
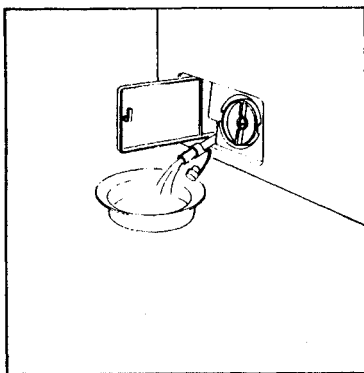
**Drain filter**

The drain filter collects fluff, buttons, pins etc. which may have been put into the drum with the laundry. You should, therefore, clean the drain filter regularly.

- Give the lock on the filter flap a quarter turn to the left using a coin. Press the left hand side of the filter flap to open.
- Remove the plug from the emergency drain hose and drain the residue water into a shallow dish (see illustration on the left above).

- Close emergency drain hose.
- Unscrew the filter anti-clockwise.
- Remove the filter and clean (see illustration on right above).
- Replace filter and close turning it clockwise. Check that the filter is closed fully to prevent leakage.

Washing powder dispenser

Leave the machine door and the dispenser open for a short time after washing to allow both to dry out. Wash out any powder left in the drawer under running water.

- To remove the dispenser from the machine hold it with both hands and give it a short sharp pull.
- Remove both U-shaped tubes and rinse under the tap.

- Replace U-shaped tubes. Check that the longer part of the »U« is placed in compartment 2 (see illustration on page 25)
- Replace the dispenser and close it firmly.

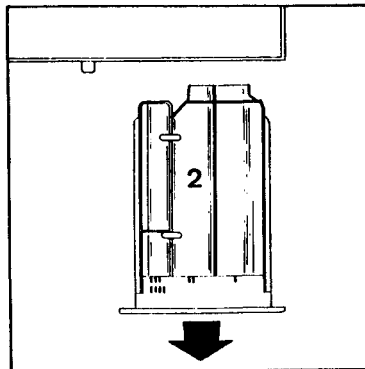
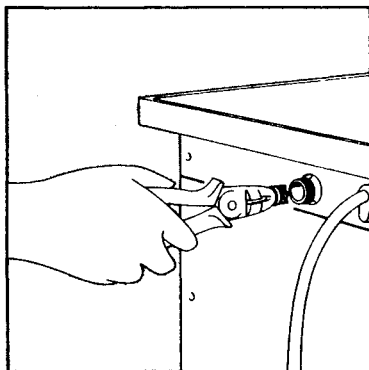

Water inlet filter

The filter traps any particles which may be present in the water supply system. If the washing powder is not fed into the machine, one of the reasons for this may be a blocked filter. To clean the filter:

- Close the water tap
- Carefully unscrew the water inlet hose from the machine.
- Remove the filter as illustrated on the left above.

- Clean under running water. Push stubborn particles through the metal mesh using a pin.
- Replace the filter and check that it is fully inserted.
- Connect the water inlet hose to the machine: open the water tap. If water is leaking from the join, tighten the screw connector carefully using a pair of pliers.

Protection against frost

If your Lavamat is installed in an unheated outhouse or laundry room, it is advisable to empty the machine of all water should there be any possibility

of frost. To do this open the emergency drain hose and disconnect the water inlet hose from the tap and drain.

How to remove the transit bars

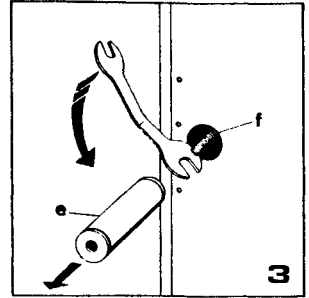
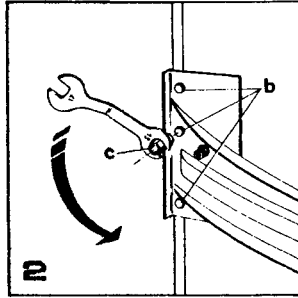
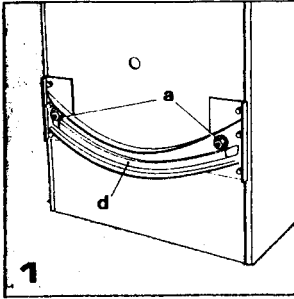

To remove the transit bars proceed as follows:

- Remove both hex. nuts (a) (illustration 1) on the rear of the machine using the spanner supplied. You will find the screwdriver in the detergent dispenser.
- Remove 3 screws (b) on either side with the spanner (c) (illustration 2).
- Pull bar (d) (illustration 1) and remove.
- Pull out distance tubes (e) (illustration 3). If necessary pull wooden batten to get a better grip on the distance tubes (e).
- Unscrew stud (f) with the spanner (illustration 3).
- Open the lock on the filter flap (front of machine) by giving it a quarter turn to the left using a coin.
- Press on the left hand side of the filter flap to open.
- Pull the cord on the left of the filter flap in the machine down by approx. 1 cm (illustration 4) to open the machine door.
- Turn the wash drum by hand anti-clockwise approx. 10 times to release the wooden batten and ancillary pieces. (illustration 5).
- Refit the 6 screws (b) and insert into the 3 large holes, the plugs provided.
- Close the filter flap and give the lock a quarter turn to the right.
- Please keep the transit bars in case the machine needs to be secured for transportation in the future (moving house etc).

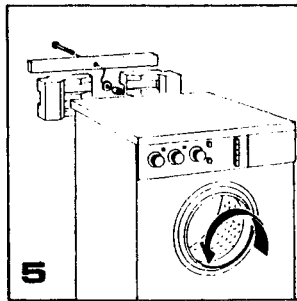
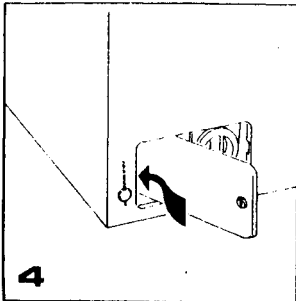

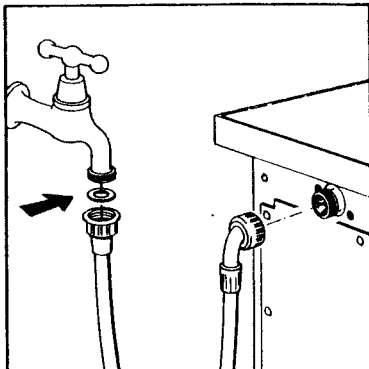
**Water supply**

Your washing machine is fitted with a high quality high pressure hose (1.2 m $\frac{3}{8}$ " bore) with a $\frac{3}{4}$ " B.S.P. screw connector for connection to a water valve with male thread. The necessary washers are enclosed. Please do not use any other washers as these may be of unsatisfactory quality). Hand tightening of the connector nut is sufficient - be very careful when using tools. See illustration above how to connect the inlet hose.

To protect the drinking water supply system, your washing machine is fitted with an antisiphon.

Please do not connect the machine to a hot water supply, as this has an adverse effect on the washing performance of the machine.

Minimum water pressure:

about 0.5 bar excess pressure (1 bar = 1 atu = 1 kgf/cm², = 10 N/cm²). Maximum permissible water pressure: about 10 bar. Where the supply pressure exceeds 10 bar, it is necessary to fit a pressure relief valve (type AD 723 E No: 612896723).

Please ensure you comply with the drinking water regulations of your local Water Board.

Should you require a longer supply hose than provided, then please use only a continuous high-pressure hose (at least 90 bar) of suitable length.

Do not extend the existing hose. On no account must you use cheap garden hoses or similar. Please ensure that suitable clamps are used for attaching the hose to the connector fitting.

Please close the water tap on completion of each wash programme.

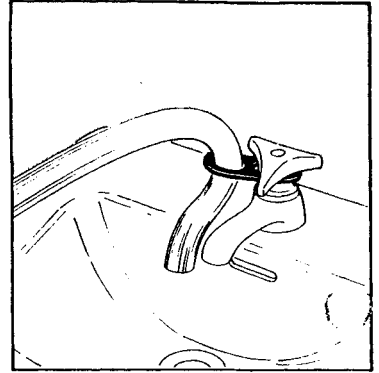
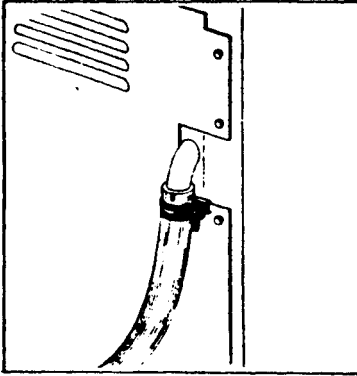

**Water
Discharge**

To drain the machine of all wash and rinse water it is fitted with a pump which is controlled by the programme. It delivers water to a height of 1 m through the drain hose.

To fit the drain hose push it approx. 3 cm over the drain hose connector and secure it with the clamp provided (illustration on the left above). Should a longer drain hose be required it may be extended up to a total length of 5 m.

The drain hose can be hooked over the sink edge.

Make sure it cannot slip off. If required use the hose holder provided as illustrated above (right).

Check that the drain hose is not kinked or twisted. If a permanent connection to a siphon is required, you can shorten the drain hose as necessary. (In this case the hose must be ventilated. The necessary ventilating valve or breather is available from your AEG Service Department).

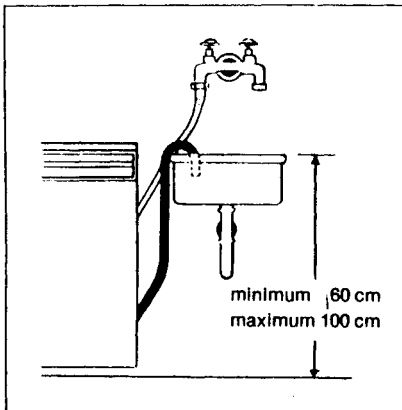

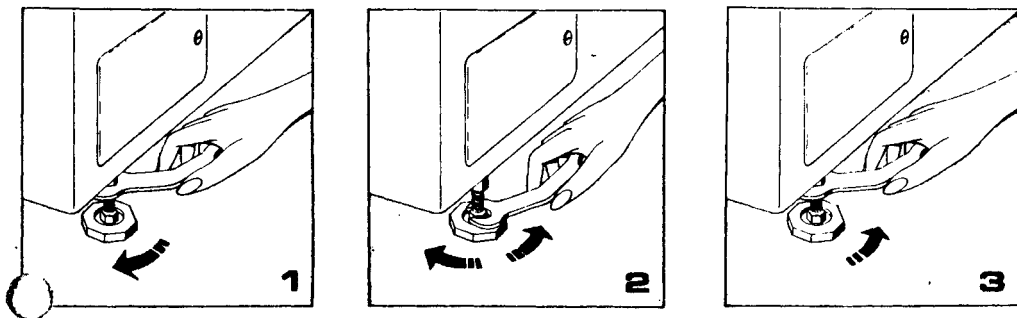

Installation

Dimensions with worktop

Height 85 cm
 Width 60 cm
 Depth 60 cm

without worktop

Height 81 cm
 Width 60 cm
 Depth 57,5 cm

The LAVAMAT stands on four adjustable feet, so that you have always the possibility to compensate uneven floor conditions or to adjust the machine to the height of the adjacent furniture units. (max. 20 mm)). To vary the height of the feet we have enclosed a spanner. Loosen lock nuts (17 mm spanner) (illustration 1).

Adjust feet higher or lower (13 mm spanner) until all four feet make firm contact with the floor (illustration 2) and the machine is level. If necessary use a spirit level. Make sure the machine does not tilt when applying pressure to one corner.

Tighten lock nuts (illustration 3).

The floor where you wish to install the LAVAMAT should be clean and free from floor polish and grease.

The machine must not be installed on long pile carpet or carpets with a foam underlay.

Should you discover some residue water in your machine please do not worry. It does not mean that the machine has been used before, but is due to the very thorough quality control at our works. Any residual water will be pumped off automatically the first time the machine is used.

Electrical connection

Connected load
 240V 50 Hz
 3.02 kW 13A

Warning! This appliance must be earthed.

Please note:

The plug moulded on the cord incorporates a fuse. For replacement, use a 13 amp BS 1362 fuse. Only ASTA approved or certified fuses should be used. The fuse cover/carrier must be replaced in the event of changing the fuse. The plug must not be used if the fuse cover/carrier is lost. A replacement cover/carrier must be obtained from authorised electrical goods retailers. If the socket outlets in your home are not suitable for the plug fitted to the appliance, then the plug must be cut off and an appropriate one fitted. When fitting the plug please note the following points:

Warning

A cut off plug inserted into a 13 amp socket is a serious shock hazard. Ensure that the cut off plug is disposed of safely.

IMPORTANT

THE WIRES IN THE MAIN LEAD ARE COLOURED IN ACCORDANCE WITH THE FOLLOWING CODE:

GREEN AND YELLOW — EARTH
 BLUE — NEUTRAL
 BROWN — LIVE

As the colours of the wires in the mains lead of this appliance may not correspond with the coloured markings identifying the terminals in your plug proceed as follows:

1. The wire which is coloured GREEN and YELLOW must be connected to the EARTH terminal in your plug, which is marked with the letter E or by the earth symbol \perp or coloured GREEN, or GREEN and YELLOW.
2. The wire which is coloured BROWN must be connected to the LIVE terminal which is marked with the letter L or coloured RED.
3. The wire which is coloured BLUE must be connected to the NEUTRAL terminal which is marked with the letter N or coloured BLACK.

When wiring the plug ensure that all strands of wire are securely retained in each terminal. Do not forget to tighten the main lead clamp on the plug.

The appliance complies with EEC directive 76/889.

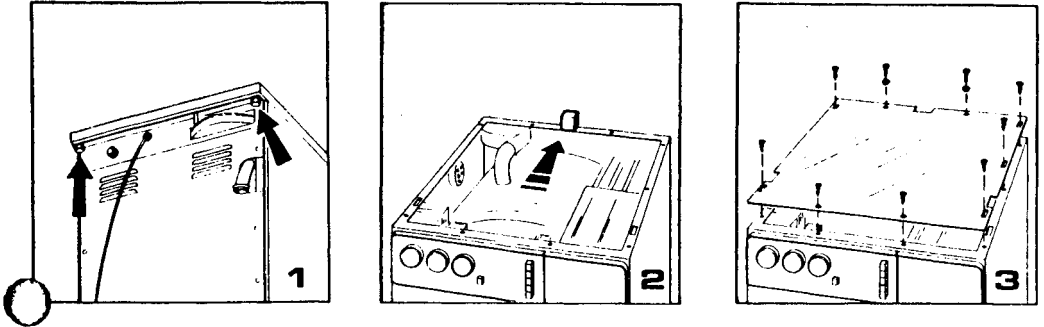

The appliance can be built-in under a continuous work surface. To remove the machine worktop proceed as follows:

- Remove both hex-headed screws under the worktop at the rear (illustration 1).
- Pull the worktop approx. 3 cm towards the rear of the machine and lift off.
- Remove plastic spacer by pushing towards the rear of the machine (illustration 2).

- A cover panel (ET - No. 645 424 013) has to be fitted to the top of the machine for safety. Secure the cover panel using the screws provided. Lock washers must be fitted to the 2 rear screws to ensure satisfactory earthing (illustration 3)
- The machine should not be connected to the mains supply until the cover is fitted.
- Ensure that the floor on which the machine will stand is level with the rest of the kitchen floor to enable the machine to be easily withdrawn in the event of service being required.

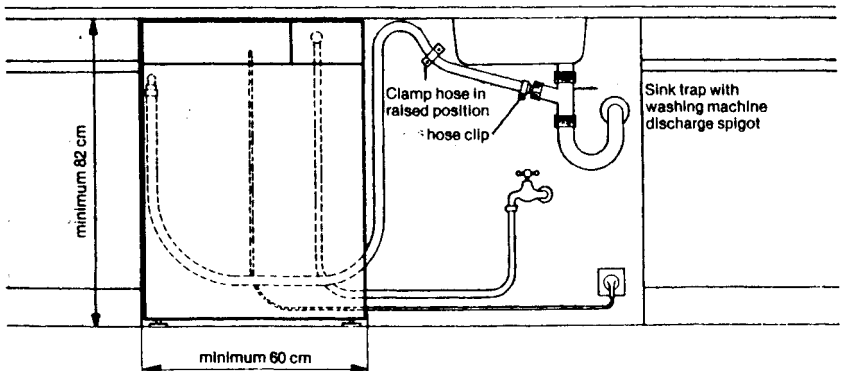

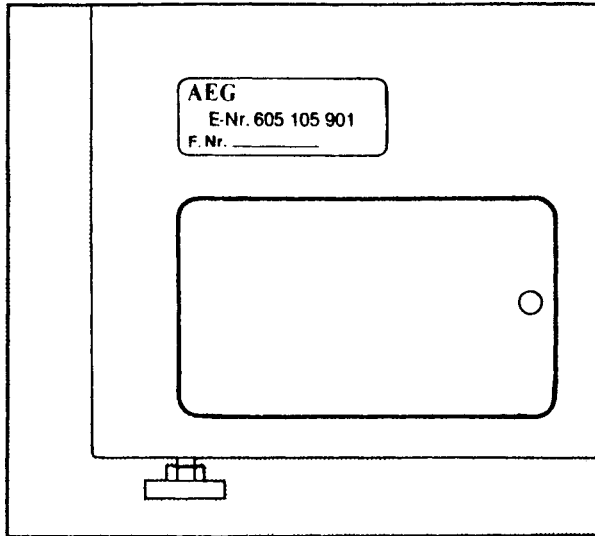

If you require to have your Lavamat serviced you will assist our service department by quoting the E-No. which we have listed above and the F-No. which you will find on the rating plate on the inside of the filter flap. Record the F-No. in the space provided above for future reference.