

IPSO - LSG n.v.



Instruction manual

**HF150 HF185
HF234**

**Technical specifications
Installation instructions
Operating instructions
Maintenance**

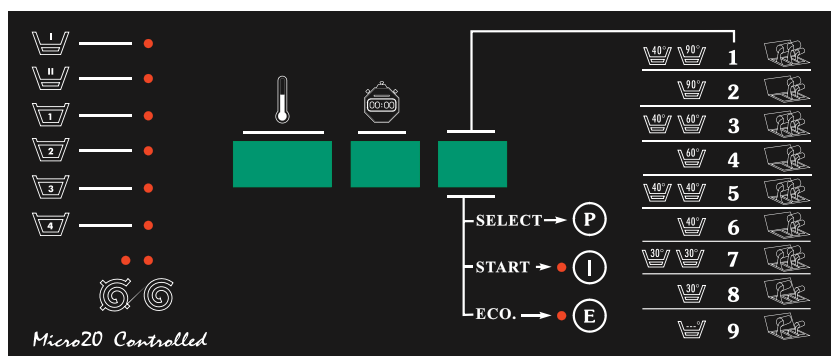

Nieuwstraat 146 - B-8560 Wevelgem (België)
Tel. 056/41 20 54 - Fax 056/41 86 74

Contents

1 General safety instructions	3
2 Technical data and dimensions	4
<i>Technical data</i>	4
<i>Dimensions</i>	6
3 Installation and connection	8
<i>Ground</i>	8
<i>Removal of the transport safety</i>	8
<i>Water connection</i>	8
<i>Water drain</i>	9
<i>Main power connection</i>	9
<i>Liquid soap connection</i>	10
<i>Connection of a central operating panel for coinmachines (option)</i>	11
<i>Steam connection</i>	12
4 Operating instructions	13
<i>Machine with start button</i>	13
<i>Machine with coin or token operation</i>	21
5 Standard programs	27
6 Technical remarks	28
<i>Internal connection of the electrical heating</i>	28
<i>Tilt switch</i>	28
<i>Error messages</i>	29
7 Maintenance of the machine	31

Code: 249/00324/20
19/12/2005

General safety instructions



Ignoring any of the safety instructions can cause serious personal injury and can also cause damage to the linen or the machine

- Read the installation and instruction manual carefully before connecting the machine.
- It is recommended that the machine be installed by qualified technicians.
- The machine should be installed according to the installation instructions. (See chapter 3)
- The machine should be grounded according to the instructions in order to eliminate the risk of electrocution.
- Do not expose the machine to high humidity or extreme high or low temperatures.
- Cut off all main water inlets, steam and electrical supplies at the end of each operating day.
- Before starting repairs or maintenance, shut off all power and water supplies.
- To prevent fire and explosion:
Keep the area around the machine free from inflammable or combustible products.
Do not put fabrics that are treated with inflammable products into the machine. These fabrics should be hand-washed or air-dried first.
- Always carefully read and follow the instructions on the packing of detergents. Store these products out of the reach of children.
- Always take into account the instructions on the labels of clothes.
- Never allow children to play in the surroundings of a machine.

Remark:

- These instructions surely cannot prevent all risks of accidents. It is up to the user to act with the utmost precaution.
- Do not hesitate to contact the dealer in case of a problem.

Technical data and dimensions

Technical data

	HF150	HF185
Capacity (dry weight)		
1/11	13 kg	16,4 kg
1/10	14,5 kg	18 kg
1/9	16 kg	20 kg
Cylinder		
Diameter	680 mm	680 mm
Depth	400 mm	500 mm
Volume	145 Lit	181 Lit
Cabinet		
Height	1348 mm	1348 mm
Width	780 mm	780 mm
Depth	840 mm	940 mm
Front loading		
Diameter door opening	395 mm	395 mm
Door height	565 mm	565 mm
To center	770 mm	770 mm
Speed		
Wash	10 - 50 tr/min	
Distribution	85 tr/min	
Low spin	250 - 500 tr/min	
High spin	500 - 1000 tr/min	
G-factor		
Low spin/high spin	94 / 380	
Motoren (3-fasig)		
4p. 1470 tr./min	2200W	
Drain valve		
Depend-O-Drain	2"	
Water supply		
Hard, soft, warm water	3/4"	
Steam connection		
Steam connection	3/8"	
Heating		
Electrical 230/400 V	12/15/18 kW	
Electrical 400V	21/24 kW	
Steam	6 bar	
Warm water (without additional heating)	X	
Warm water (with additional heating)	X	
Packing dimensions		
(H x W x D) mm	1495x850x930 - 1495x850x1030	
Weight		
Nett	424 kg	454 kg
Gross	440 Kg	470 kg

Technical data and dimensions

Technical data

		HF234
Capacity (dry weight)		
	1/11	21,3 kg
	1/10	23,4 kg
	1/9	26 kg
Cylinder		
	Diameter	750 mm
	Depth	530 mm
	Volume	234 Lit
Cabinet		
	Height	1505 mm
	Width	900 mm
	Depth	985 mm
Front loading		
	Diameter door opening	395 mm
	Door height	630 mm
	To center	820 mm
Speed		
	Wash	10 - 50 tr/min
	Distribution	100 tr/min
	Low spin	250 - 500 tr/min
	High spin	500 - 1000 tr/min
G-factor		
	Low spin/high spin	74/ 373
Motoren (3-fasig)		
	4p. 1470 tr./min	3000W
Drain valve		
	Depend-O-Drain	3"
Water supply		
	Hard, soft, warm water	3/4"
Steam connection		
	Steam connection	3/8"
Heating		
	Electrical 230/400 V	12/15/18 kW
	Electrical 400V	24 kW
	Steam	6 bar
	Warm water (without additional heating)	X
	Warm water (with additional heating)	X
Packing dimensions		
	(H x W x D) mm	1650x 1020x 1150 mm
Weight		
	Nett	570 kg
	Brutt	630 kg

Dimensions

HF150 - 185

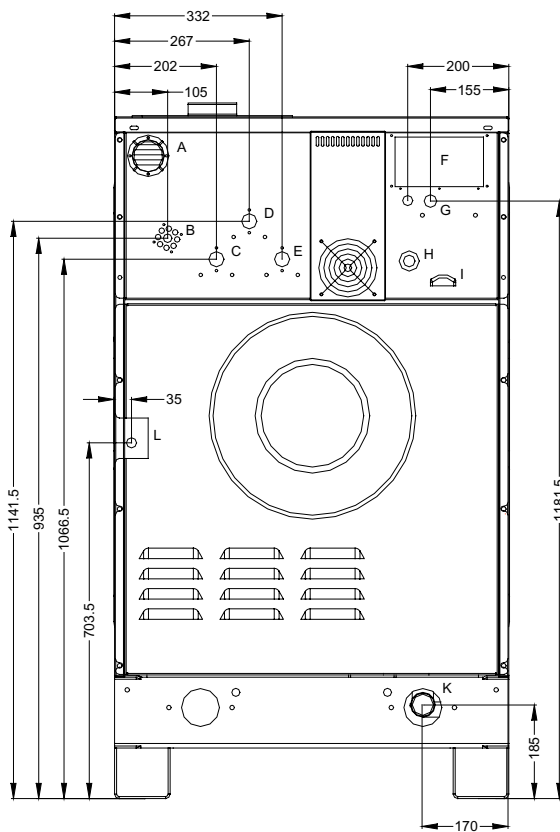
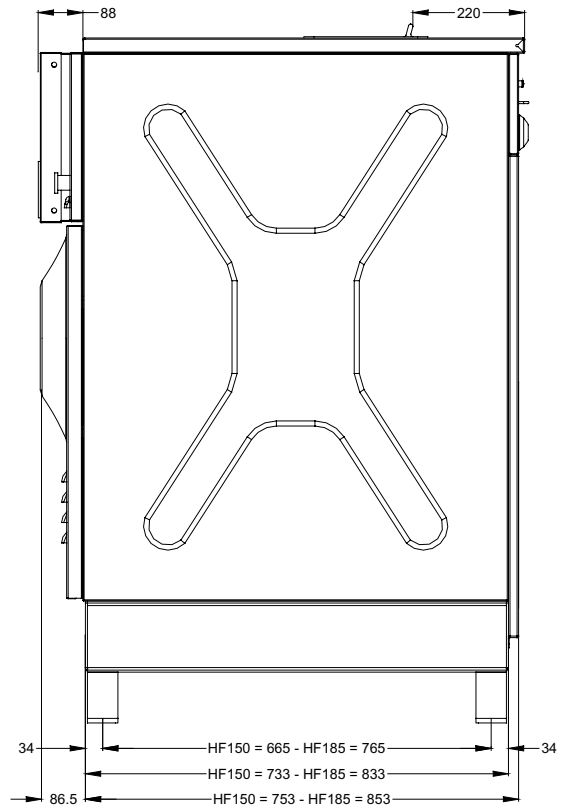
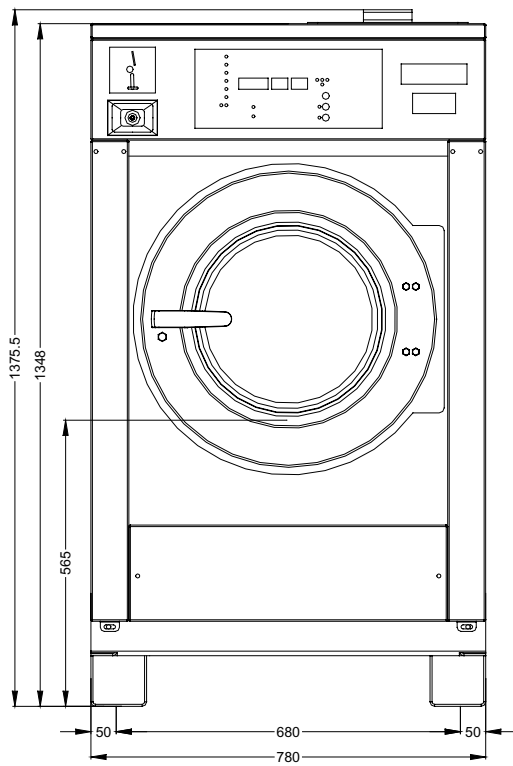

- A. Ventilation soap dispenser
- B. Liquid soap connetions
- C. Hard water connections 3/4"
- D. Warm water connections 3/4"
- E. Soft water connections 3/4"
- F. Connections clamps
- G. Electrical connections
- H. Emergency button
- I. Ventilation tub
- K. Drain valve
- L. Steam connections

Dimensions

HF234

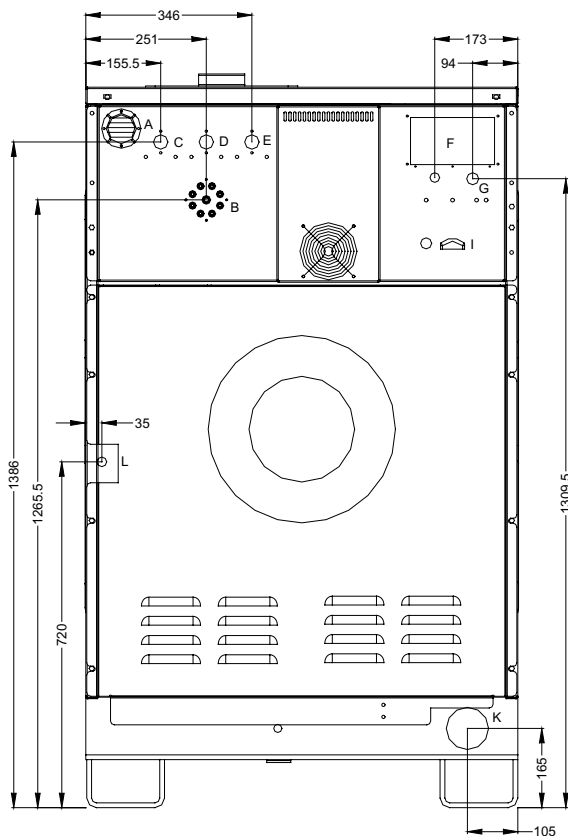
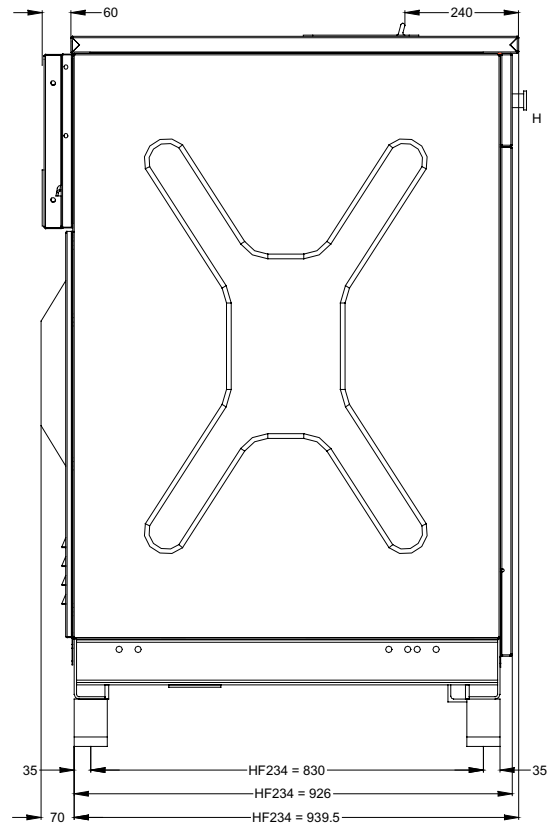
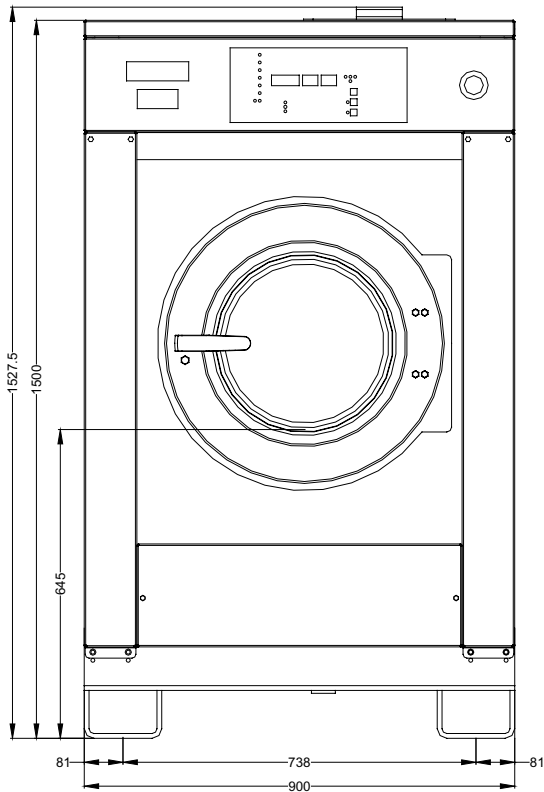

- A. Ventilation soap dispenser
- B. Liquid soap connetions
- C. Hard water connections 3/4"
- D. Warm water connections 3/4"
- E. Soft water connections 3/4"
- F. Connections clamps
- G. Electrical connections
- H. Emergency button
- I. Ventilation tub
- K. Drain valve
- L. Steam connections

Installation and connection

Ground

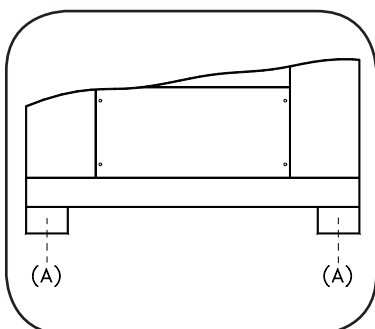

The machine must be placed on a flat, solid surface (metal base, concrete or solid ground). It is **recommended that the machine be anchored** on the provided places (A) in the base, especially in case of a plinth (see Dimensions 2).

The machine must be placed entirely level. For easy maintenance it is recommended to keep a minimal distance of 600 mm between the wall and the back of the machine.

If several machines are placed next to each another, there should be a minimal distance of 30 mm between each machine.

Removal of the transport safety

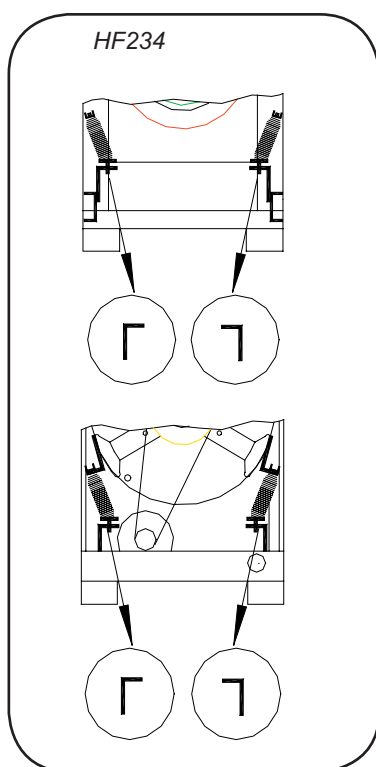

To prevent damage during transportation, the machine has been equipped with four red transport brackets to eliminate every possible movement of the tub.

After the machine has been placed level, take off the service- and the back panel to remove these transport brackets.

Important

The machine must never be activated **before removing these transport brackets**.

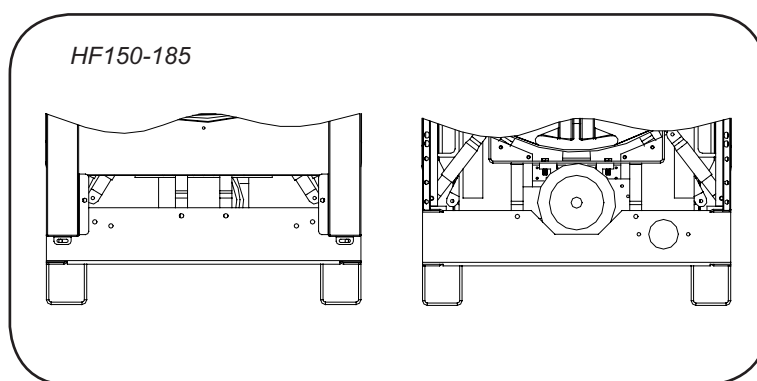

Water connection

The machine is delivered with hoses with 3/4" connections. These hoses fit the water inlet valves of the machine and the main water inlet taps. To ensure the optimal functioning of the water inlet valves, the water pressure on the inlet should be between 0,5 and 10 kg/cm² (7 and 145 psi). If the pressure is too low, the cycle time will increase considerably.

In case of boiler fed machines, a minimum of hot water of 90°C should be available: For the HF150: 94 l. HF185: 115 l. HF234: 150 l.

Water drain

The machine is equipped with a drain valve (HF150-185) with 2" outer diameter (50mm) (HF234) 3" outer diameter (80 mm). This drain valve should be connected to the drain by means of the drain elbow which is delivered with the machine.

- The diameter of the main drain should be adapted to the water flow and the number of machines. It should be sufficient to handle at least 160L/min. per machine.
- It is necessary to connect the main drain at least on one side to an open air-brake to allow ventilation.
- When the main drain has not been sufficiently deodorized, every machine should be installed separately with a deodorizer.

Electrical Connection

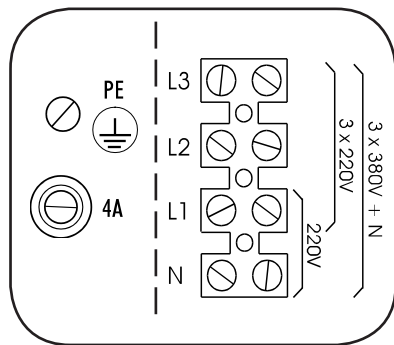

- Remove the cover plate at the back of the machine. (See dimensions (E)).

- Connect the power cable to the connectors.

220V 3AC

220V 3 phase (3AC) should be connected to the connectors "**L1,L2,L3**".

The green/yellow grounding clamp has to be connected to the grounding wire "**PE**".

380 V 3AC + N

380 V 3 phase (3AC + N) has to be connected to the connectors "**L1,L2,L3**", **the blue neutral to the "N" connector**.

The green/yellow grounding clamp has to be connected to the grounding wire "**PE**".

- After connection, check the **spin direction**. The cylinder must spin in the **direction of the arrow**, showed on the sticker on the door window (**clockwise**).

- A wrong spin direction can damage the motor, and can also cause water to spurt from the soap dispenser.

Power of the breaker plugs:

machine with steam heating or boiler fed machines without additional electrical heating

220V 3AC	380V 3AC + N
16 A	16 A

machine with electrical heating

	220V 3AC	380V 3AC + N
9kw	25A	16A
12 kW	40 A	20 A
15 kW	50 A	25 A
18 kW	50 A	32 A
21 kW	----	40 A
24 kW	----	40 A

Liquid soap connection (option)

Connection of the liquid soap hoses

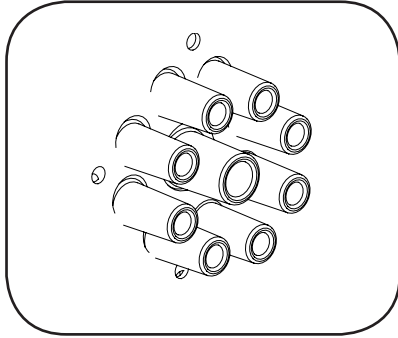

The liquid soap connection consists of **8 connections for liquid soap** (S1...S).

The central opening is used for ventilation.

Electrical connection of the liquid soap pumps

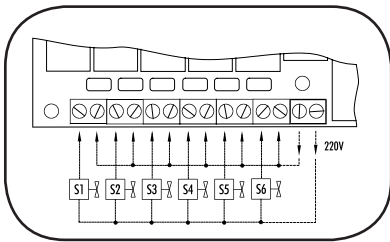

On machines equipped with a liquid soap connection, connect the wires **directly on the print board** next to the ground wire connection (option). Connect as indicated on the wiring diagram.

The two connectors on the right give a tension of 220V ~ (max. 4A) which can be applied to drive 220V ~ soap pumps. If more than **4A** is required, **an external tension** will have to be used. **6** connections have been provided, of which one (**S6**) can be used to drive a waterproofing pump (e.g. for rain coats, etc.).

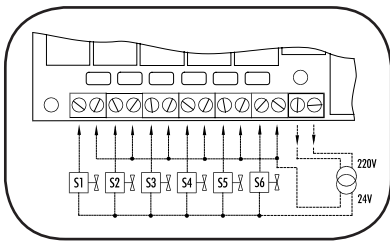

The 220V can be transformed to other values to drive other type soap pumps.

Example: pumps 24V ~.

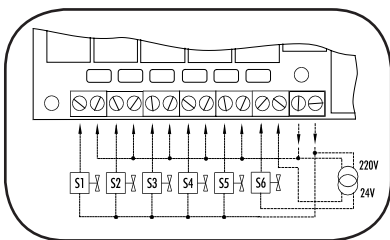

Also, pumps with different operating tension can be combined.

Example: 5 pumps 220V ~ and 1 pump 24V ~.

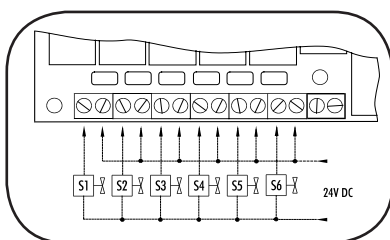

With an external tension 24V DC

Connection of a central operating panel for coinmachines (option)

At the backside above the main connectors, you find a printboard, to which the central operating panel for coinmachines can be connected.

The right connectors form a potential free output contact as a result of which the operating

panel detects when the machine is activated or not.

The left connectors receive the signal, by means of which a machine is chosen through the operating panel.

There are 3 different variations possible according to the output voltage of the operating panel.

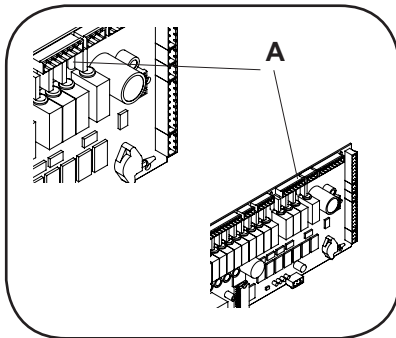
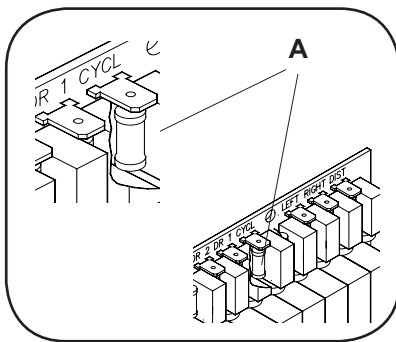
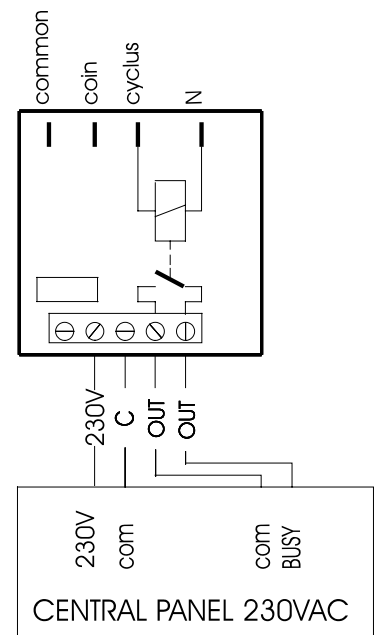
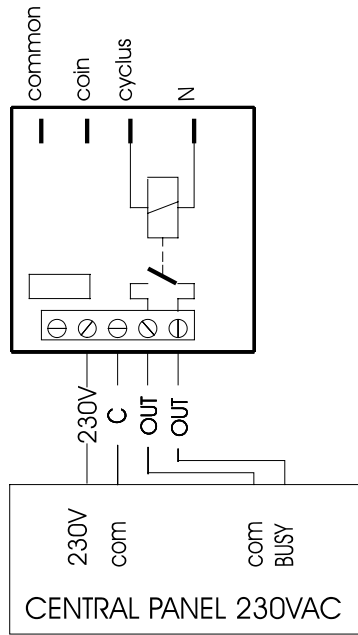
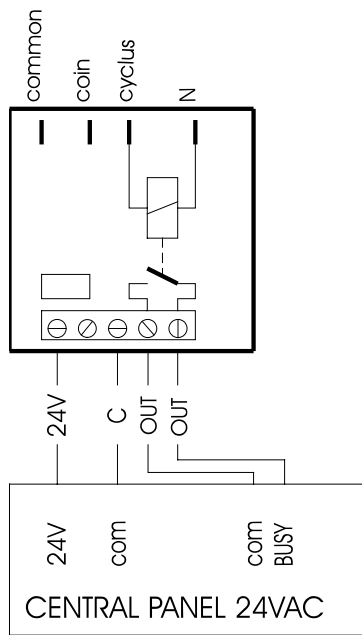

Remark : If a machine is equipped with this kind of printboard or if a printboard has been built in, the **resistance of the cycle contact (A) may no longer be present** on the main printboard. **When this resistance is present, it has to be cut out of the main printboard.**

Steam connection

Machines with steam heating must have a steam valve between the steam installation and the machine.

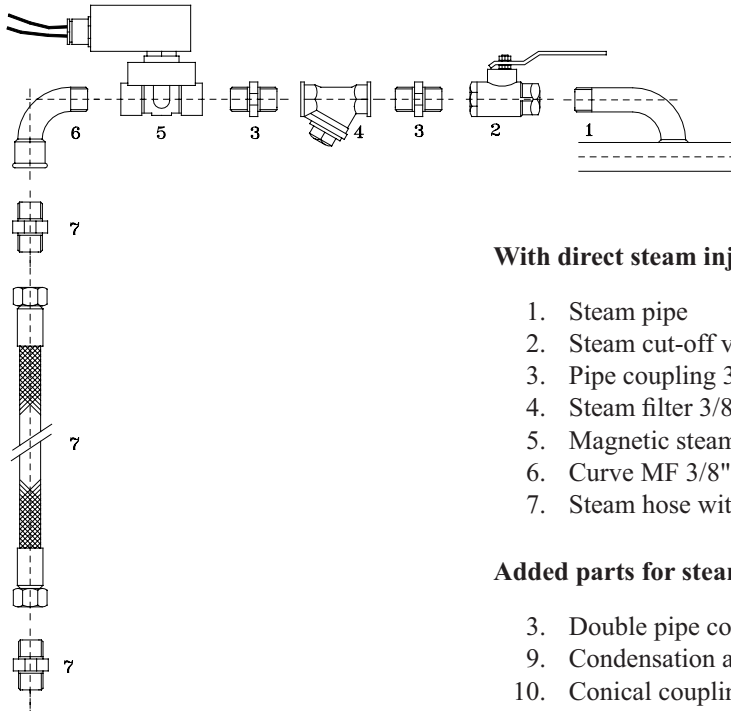

With direct steam injection into the machine

1. Steam pipe
2. Steam cut-off valve 3/8"
3. Pipe coupling 3/8"
4. Steam filter 3/8"
5. Magnetic steam valve 3/8"
6. Curve MF 3/8"
7. Steam hose with appropriate pipe coupling 3/8"

Added parts for steam heating with heat exchanger

3. Double pipe coupling 1/2"
9. Condensation accumulator with filter 1/2"
10. Conical coupling MM 1/2"
11. Single window 1/2"
12. One-way valve 1/2"

M = inner wire, F = outer wire

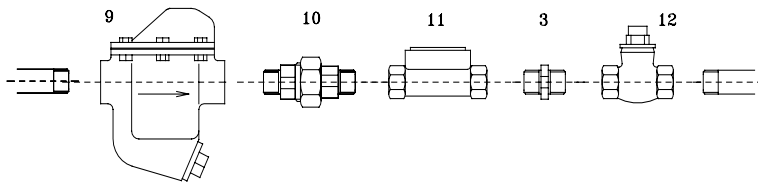

The manufacturer is not responsible for damage or accidents caused by not following the installation instructions!

Operating instructions

Machine with start button

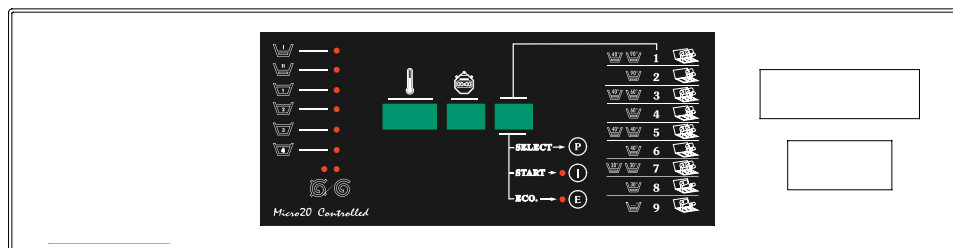

Opening the door

Open the door.

Fill the drum

Sort the linen according to the type and required temperature of the linen. Empty all pockets of the garments so that no garments can be damaged and no left articles can cause damage to the machine. Turn sleeves of shirts, blouses inside out. It is recommended to mix small and large items to enhance the drop of the linen during the wash cycle and hence improve the wash quality. Wash loads of **below 80% of machine capacity** can obstruct the proper functioning of the machine and can **damage the machine**. Overloading the machine can also lead to a bad wash result.

Close the door

Select program

On machines with a start button, the programmer can contain up to 100 programs (0-99). The program number is displayed on the **right display**.

By pressing the SELECT-button (P), the next program will be displayed.

By pressing the ECO-button (E), the previous program will be displayed. By keeping this button pressed, this function will be accelerated.

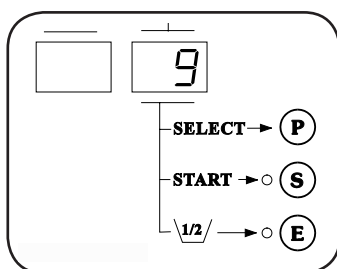

Remark

Select program "0" by keeping the SELECT-button pressed continuously for more than 5 seconds.

Add detergent

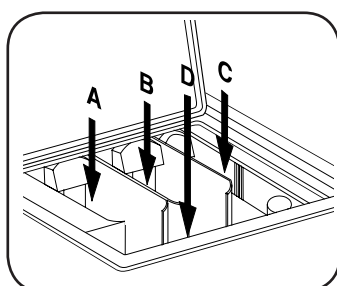

It is recommended to only use detergents with a "foam-breaker". These are often found in the launderette or laundry or can easily be found in retail stores. Recommended doses are mentioned on the detergent packing.

Overdosing of detergents can lead to reduced wash results and "overfoaming" which can damage the machine.

Left compartment A:	Prewash (1st wash)
Central compartment B:	Main Wash (2nd wash)
Right compartment C:	Final Rinse (fabric softener)
Bottom compartment D:	Direct access to tub

Economy Wash

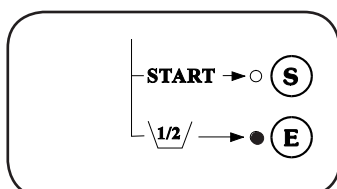

Moderately soiled linen can be washed using the Economy Wash function, which reduces the water level of washes and rinses by **20%**, allowing savings of water and energy.

Press the ECO-button **during the wash cycle** to activate the economy wash function. The ECO-LED will light up.

At the **end of the program** the ECO-function will be automatically eliminated. If the ECO-function is required in the following wash cycle as well, reactivate this function by repeating the actions described above.

Start the machine

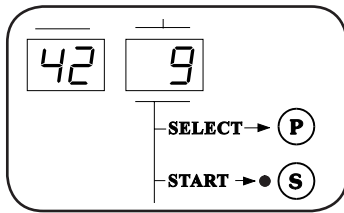

Start the wash-cycle by pressing the Start button (S) and releasing it immediately. The door is sealed and the cycle-LED lights up.

During the first **2 minutes** after starting, the program number is blinking and you can change the program in case of a possibly wrong selection. To do so, select another program with the SELECT button (P). This new program will start immediately.

Indications of program sequence

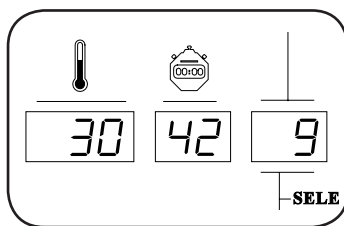

Display information

The **left display** will indicate *the temperature of the wash bath* - in °C or °F (on machines where this function has been selected).

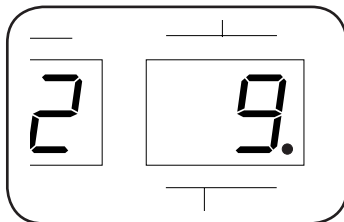

The **central display** shows *the remaining time* to the end of the wash cycle. For programs which are being run for the first time, the machine will take a theoretical time estimate. If this time indication does not correspond to the real cycle time, the cycle time will be corrected from the second cycle onwards (*Self-Teaching function of the machine*).

This correction will have to be preprogrammed and is **not activated on program numbers higher than 20**. The corrected time will also be lost when the power has been cut from the machine for more than 24 hours.

The **right display** will continue to show the *selected program number*.

If a Level-stop was programmed (which halts the programmer during the filling of the cylinder) and/or a Heat-stop (which stops the programmer during the heating up of the wash bath, then the respective LED's light up in the display. Once the required water level and/or temperature have been reached, the LED is turned off and the internal programmer advances again.

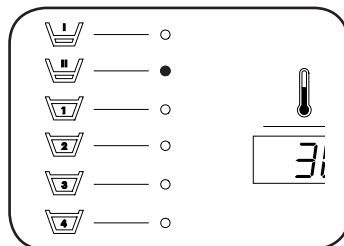

Wash cycle-LED's

Each program segment has a corresponding LED. Each of these 6 LED's light up when the appropriate segment is executed. This way, the program sequence can be accurately followed.

When a LED **blinks**, the machine is taking up water.

When a LED **blinks slowly**, the machine is heating up the water.

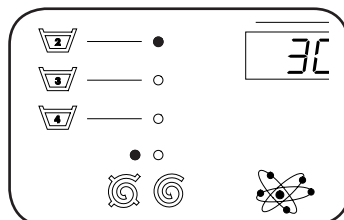

Spin-LED's

When the water is drained at the end of a program segment and the machine spins if so desired, the **left spin-LED** (intermediate spin) will light up together with the cycle-LED.

- Functioning of the spin-LED's during intermediate spin:

LED	drain/distribution	low spin	coast
Interm. spin	blinking rapidly	continuously	continuously

- Functioning of the spin-LED's during gentle-intermediate spin:

LED	drain/distribution	low spin	coast
Interm. spin	blinking rapidly	blinking slowly	blinking slowly

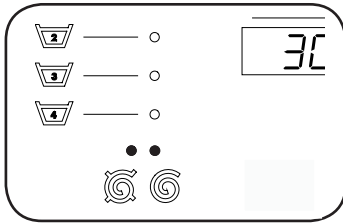

During final spin, both the *left spin-LED* (intermediate spin) will light up together with the *right spin-LED* (final spin).

- Functioning of the spin-LED's during final spin:

LED	drain/distribution	low spin	high spin	coast	tumble
Interm. spin	blinking rapidly	continuously	slowly	continuously	off
Final spin	continuously	continuously	slowly	continuously	rapidly

- Functioning of the spin-LED's during gentle-final spin:

LED	drain/distribution	low spin	high spin	coast	tumble
Interm. spin	blinking rapidly	slowly	----	slowly	off
Final spin	continuously	continuously	----	continuously	rapidly

Manual interventions during the program

Following functions can be activated during the program:

F1 = Time stop

To increase the duration of a program segment beyond its originally programmed duration.

F2 = Soak

To soak heavily soiled linen

F3 = Reduced wash action

To avoid wear of delicate garments

F4 = Execute high spin as low spin

To avoid creasing delicate linen

F5 = Rapid advance

To skip certain program segments

F6 = No spin

To give total protection to delicate garments

F7 = on the left display appears the number of revolutions of the drum.

F8 = changing the number of revolutions at final spin. In order to limit the rpm for delicate linen.

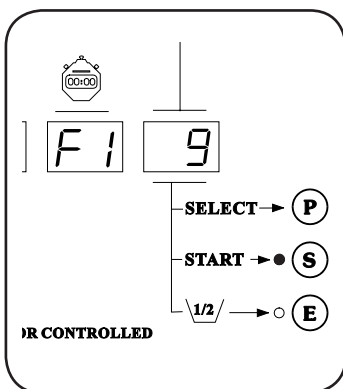

Selecting a function

Push the SELECT-button (P) at the time the special function needs to be activated *and keep the button depressed*.

Now push the START-button (S) *simultaneously and release same*. *Only now release* the SELECT-button (P).

The central display now shows *F1* and this *function is now active*.

By pressing the SELECT-button (P) the next function will appear on the central display. And so on up to F8.

To return to normal operation, press the START-button (S) and release.

A function is also terminated by *selecting another function*. Functions are also *automatically ended and switched off at the end of the each program*.

Description of the functions

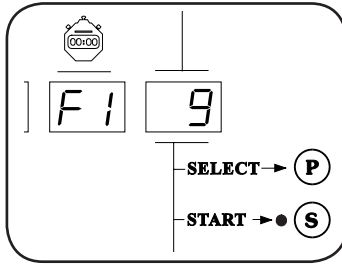

Function F1 (Time stop)

During the wash cycle:

The **wash time is stopped**. The temperature, water level and wash action **remain the same as programmed**.

During the wash cycle, this function remains active until the **START button (S) is pressed again**.

During intermediate spin :

The intermediate spin normally lasts 1 minute.

By activating function F1, the machine will spin for **nine minutes** unless the START button (S) is pressed earlier.

During final spin :

At final spin, you have high spin after low spin.

By activating F1 during low spin, this low spin will be extended to **15 minutes** unless the START button (S) is pressed earlier.

If the 15 minutes of low spin have been completed, the high spin is **automatically canceled**.

By activating F1 after the preprogrammed low spin, you will have a maximum of **14 minutes** of high spin unless the START button (S) is pressed earlier.

Adjustable stop time :

Here you can program a certain stop time. The display shows the countdown of this extra time. When this time is expired, the function will appear automatically and the program will continue.

Select F1 (see above).

The stop time can be programmed by means of the ECO button (E). By pressing it once, the stop time is programmed for 10 minutes. From now onwards, **"F1"** and **"10"** appear **by turns on the middle display**.

By pressing the ECO button (E) once more, you **add** each time 10 minutes.

After 50 minutes, 1.0, 1.1, 1.2, etc... appear with a maximum of 4.0 hours. By means of the START button (S), you can each time **reduce** 10 minutes.

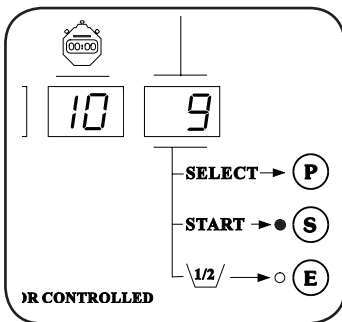

Remark :

The programmed stop time is executed after the decimal point in the right display has extinguished.

The stop time cannot be programmed during spin.

Function F2 (soak)

This function can only be chosen during prewash, main wash and first rinse.

The **cycle time is stopped**. The bath is filled till **high water level** and heated up to 40 °C (if a higher temperature was programmed, this will be followed).

As long as this temperature is not reached, the machine makes a **reduced wash action** (shorter action time and longer pause time). When the bath has reached its temperature, the drum will make one left/right rotation every **4 minutes**. Should the temperature fall, the water will be heated again, during which the action will be reduced again.

This function remains active until the **START button (S) is pressed again**.

Programmable soak time :

In the same way as for the stop time, you can program the soak time (see programmable stop time).

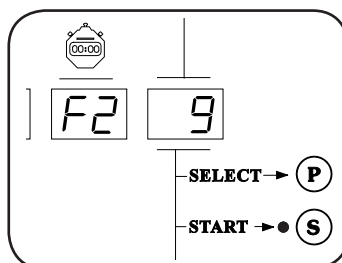

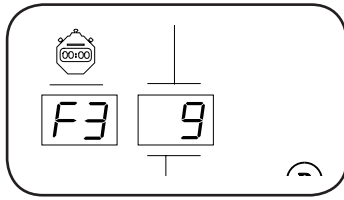

Function F3 (reduced wash action):

By selecting F3, the *wash action time and pause time will be reversed*; unless the wash action time was programmed to be shorter than the pause time.

Example: 12 sec. action/3 sec. pause becomes: 3 sec. action/12 sec. pause
6 sec. action/9 sec. pause remains: 6 sec. action/9 sec. pause

This function does not influence the cycle time - the program continues normally - and remains active until the START-button (S) is pressed.

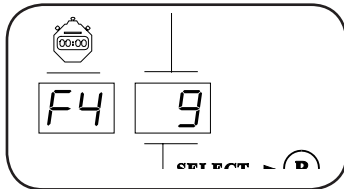

Function F4 (execute high spin as low spin):

By activating this function, *high spin will be automatically replaced by low spin*.

This function does not influence the cycle time - the program continues normally - and remains active until the START-button (S) is pressed.

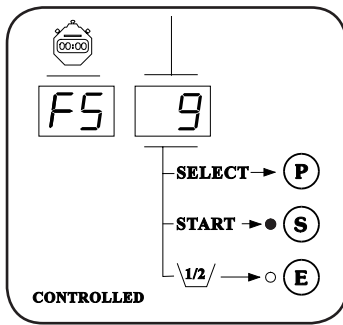

Function F5 (rapid advance):

This function is mostly used by technicians and maintenance staff. It allows to the program.

By pressing and releasing the ECO-button (E), the programs skips to the next segment.

Attention!

If F5 is activated during final spin, this segment of the program will be skipped as described above. It is however followed by a coast and tumble time to disentangle the linen. This special function prevents the user from opening the machine while the drum is still rotating and represents an important safety feature.

To return to normal operation, press the START-button (S).

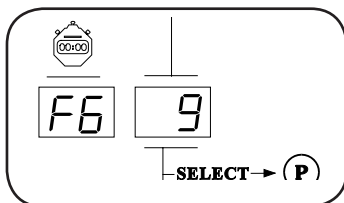

Function F6 (no spin):

This function eliminates all spin action.

Intermediate spin is replaced by a regular wash action. During final spin, only the programmed low spin time will be completed as regular wash action. High spin is skipped in its entirety.

This function influences the cycle time - the program continues normally - and remains active until the START-button (S) is pressed.

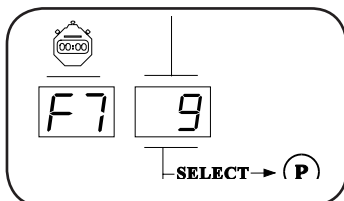

Function F7 (indication of the rpm)

By using F7 the number of revolutions of the drum (rpm) appears on the right display.

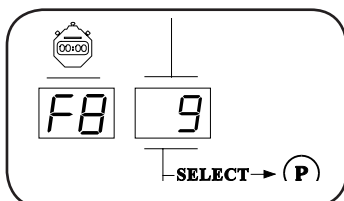

Function F8 (changing the number of revolutions (rpm) at final spin)

By means of F8, the number of revolutions can be changed at high spin. The programmed number of revolutions appears on the left display.

Each time you press the ECO button (E), the spin *decreases with 25 rpm (min.500)*.

Each time you press the START button (S), the spin *increases with 25 rpm (max. 999)*.

Remark :

This function has to be selected before final spin has started.

End of a program

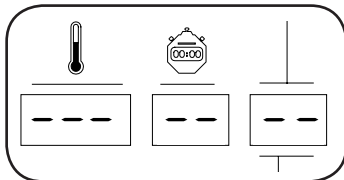
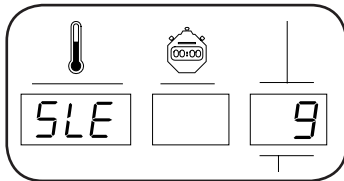
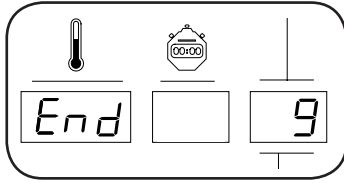

At the end of a program, while the door is being released, the left display shows **End**; and the **Start-LED is switched off**.

After that only the right display will continue to show the program number. This is the end of the program.

Premature ending of the program

By pressing the START-button (S) during the program, the Start-LED is switched off and the water is drained from the machine. As long as the water has not reached the safety level, the door will remain sealed and the display will show “**SLE**” (Safety Level) on the **left display**. Afterwards the display will temporarily show “**End**” on the same display **and the Start-LED will be switched off**. After that only the right display will continue to show the program number. This is the end of the program.

Remark:

If any attempt is made to interrupt the program prematurely **during a spin phase** of the program, all functions on the display will be temporary replaced by blinking **horizontal dashes**. After that only the right display will continue to show the program number and the door will be released. This is the end of the program.

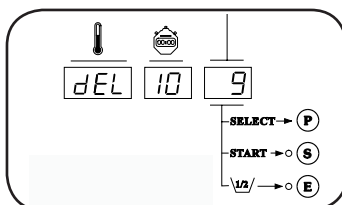
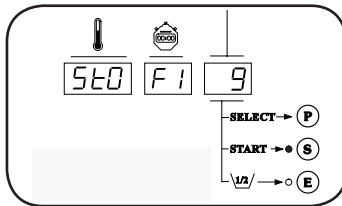
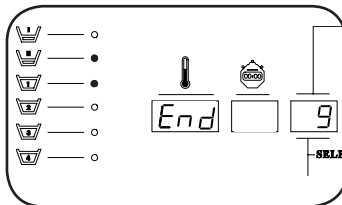
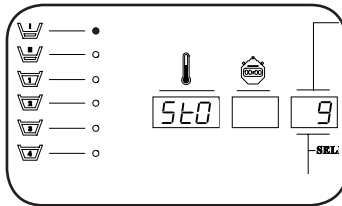
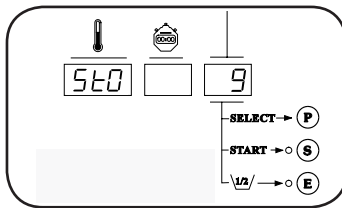
Remarks:**Freely programmable stop-function**

Before starting a program it is possible to preprogram a time stop *in every program segment*. This function permits special additional functions like adding bleach or extra detergent to the wash bath.

Programming:

After selecting the program, press the ECO-button (E) *and keep it depressed*.

Now push the START-button (S) *simultaneously and release same*. *Only now release the ECO-button (E)*.

The left display now shows “StO” (Stop) and the right display shows the program number. The first program sequence LED is switched on.

Confirm by pressing the START-button (S) if a time stop is required in this phase of the program. If no time stop is needed, press the ECO-button (E) to move on to the next segment of the program. Run through the entire program in this way. If needed, return to previous segments by pressing the SELECT-button (P).

Errors can be corrected by returning to the erroneously programmed time stop in the segment and correcting by pressing the START-button (S).

After the final program segment all programmed time stops will be displayed and the left display will show “End”. Confirm this program by pressing the START-button (S) again. Now start the program.

Operation:

When a stop is reached during the run of the program, the *time will be stopped*. The wash bath will *be filled to the appropriate level and temperature* and the *programmed wash action is executed*.

The left display will alternately show *temperature and “StO”*, while the central display is showing “FI”. Now, if so desired, additional detergents can be added.

When this has been done, press the START-button (S) to continue the run of the program. To remove any possible remains of corrosive products in the tub, the machine will rinse an additional **2 seconds**.

Programmable automatic start

By using this function a program can be started up to **99 hours** later.

Programming:

After selecting the program, press the SELECT-button (P) again *and keep it depressed*.

Now push the START-button (S) *simultaneously and release same*. *Only now release the SELECT-button (P)*.

The left display now shows “DEL” (Delay). The central display shows “10” (minutes). Every push on the SELECT-button (P) will add **10 minutes** to the delayed start time. Hours and minutes are separated by a decimal point: **1.5** stands for 1 hour and 50 minutes. After **10**, the counting is done *by hours*.

By pressing the ECO-button (E), the delay time can be counted down.

Operation:

After having set the desired delay time, the count-down can be started by pressing the START-button (S). During the count-down *the displays blink* and the remaining time is counted down. In the last hour the displays blink faster. When the delay time has elapsed, the program is started automatically.

Linking 2 programs

It is possible to run 2 programs automatically in sequence. This can be handy to perform very special functions (like waterproofing outerwear) and add these to the wash program.

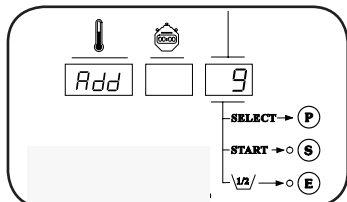

Programming:

First select the program which will be run last.

Now, press the START-button (S) and **keep it depressed for at least 5 seconds**. The left display now shows "Add". Now select the program which **will be run first**.

The right display now shows both linked programs **alternately**: the first to be run program during the longer time span alternating with the following program displayed during the shorter time span.

This function is canceled by pressing the START-button (S) again for at least **5 seconds**.

This function **can be combined** with an economy wash, with the functions F1 to F6 and with a programmed start. The **freely programmable stop-function** can however only be executed during the first program.

Operation:

Press the START-button (S) to start the programs. The central display will show the remaining time **per program**. The total time of both programs together is **not displayed**.

The right display **alternately shows** the program in operation (during a longer time span) and the second program to be executed (during the shorter time span). After the first program has been run, only the second program number will be displayed.

Cool down

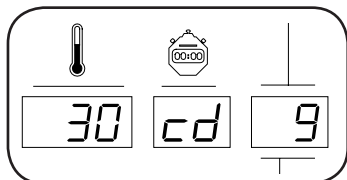

This function allows to gradually lower the temperature of the wash bath to prevent creasing of the linen.

During a cool down, the remaining program time on the central display will be replaced by "cd".

Power Failure

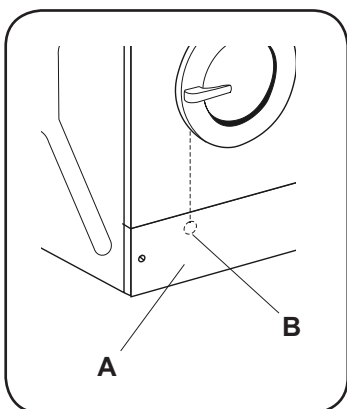

Should the power fall out during the program, the water will be drained and the door can be opened after maximum 3 minutes. When the door remains locked, and the power comes back up within 24 hours, the program will continue from there, where it was at the time of the power failure.

If due to breakdown, the door is not unlocked automatically, you have to remove the service panel (A) below and pull the ring (B), suspended on the left side, while opening the door.

Important:

Before opening the door, check that all the water has been drained from the tub and that the cylinder has come to a complete stop.

Remote stop function

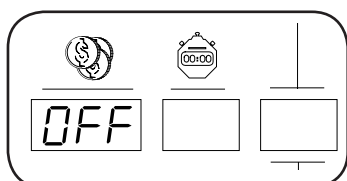

By means of this function, **no cycles can be selected anymore during a certain period of time** (e.g. between 10 p.m. and 7 a.m.). This time is determined by an **extern timer**. As soon as the last cycle is finished, "OFF" (blinking) appears on the left display as long as this function is activated.

Machine with coin or token operation

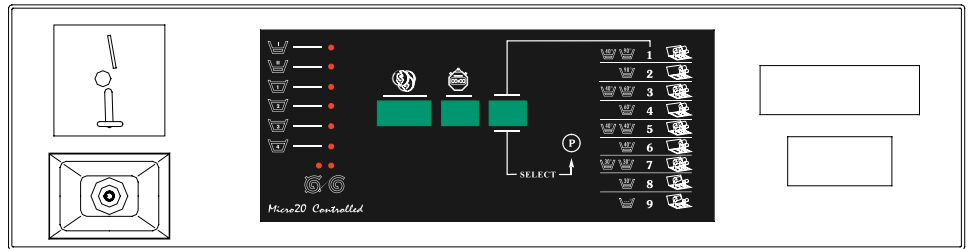

Opening the door

Open the door.

Fill the drum

Sort the linen according to the type and required temperature of the linen. Empty all pockets of the garments so that no garments can be damaged and no left articles can cause damage to the machine. Turn sleeves of shirts, blouses inside out. It is recommended to mix small and large items to enhance the drop of the linen during the wash cycle and hence improve the wash quality. Wash loads of **below 80% of machine capacity** can obstruct the proper functioning of the machine and **can damage the machine**. Overloading the machine can also lead to a bad wash result.

Close the door

Select program

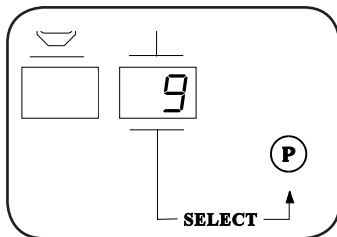

On machines with a coin or token meter, the programmer can contain up to 20 programs (0-19). The program number is displayed on the right display. By pressing the SELECT-button (P), **the next program** will be displayed.

Add detergent

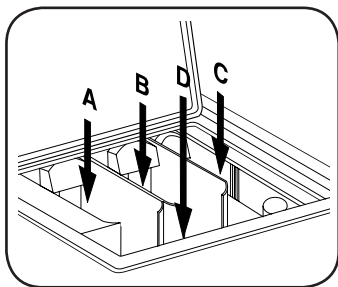

It is recommended to only use detergents with a “**foam-breaker**”. These are often found in the launderette or laundry or can easily be found in retail stores. Recommended doses are mentioned on the detergent packing. Overdosing of detergents can lead to reduced wash results and “**overfoaming**” which can damage the machine.

Left compartment A:	Prewash (1st wash)
Central compartment B:	Main Wash (2nd wash)
Right compartment C:	Final Rinse (fabric softener)
Bottom compartment D:	Direct access to tub

Start the machine

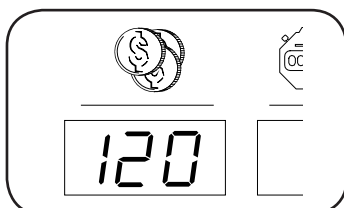

The price will be displayed on the left display. The display will count down every time a coin is introduced into the coin meter. When the total price has been introduced into the machine, the display will be switched off and the machine will start.

During the first **2 minutes** after starting, the program number is blinking and you can change the program in case of a possibly wrong selection.

To do so, select another program with the SELECT button (P). The new program will be started **immediately**.

If a **more expensive program** has been selected, the **price difference with the previous program** will be displayed. The new program will only start after this price difference has been introduced. If this has not been done within two minutes of selecting the new program, the machine will switch back to the original program and continue operating.

Indications of program sequence

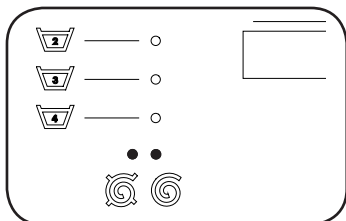
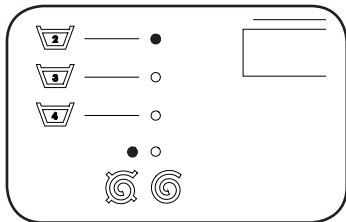
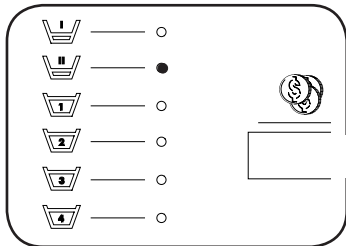
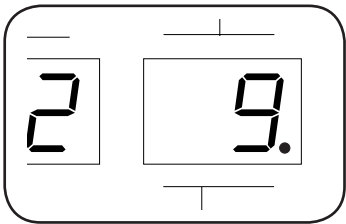
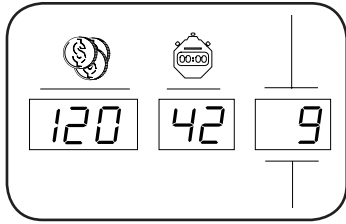

Display information

The *left display* will indicate **the temperature of the wash bath** - in °C or °F (on machines where this function has been selected).

The *central display* shows **the remaining time to the end of the wash cycle**.

For programs which are being run for the first time, the machine will take a theoretical time estimate. If this time indication does not correspond to the real cycle time, the cycle time will be corrected from the second cycle onwards (*Self-Teaching function of the machine*).

This function has to be specified during preprogramming.

The *right display* will continue to show **the selected program number**.

If a **"Level-stop"** was programmed (which halts the programmer during the filling of the cylinder) and/or a **"Heat-stop"** (which stops the programmer during the heating up of the wash bath, then the respective LED's light up in the display. Once the required water level and/or temperature have been reached, the LED is turned off and the internal programmer advances again.

Wash cycle-LED's

Each program segment has a corresponding LED. Each of these 6 LED's light up when the appropriate segment is executed. This way, the program sequence can be accurately followed.

When a **LED blinks**, the machine is taking up water.

When a **LED blinks slowly**, the machine is heating up the water.

Spin-LED's

When the water is drained at the end of a program segment and the machine spins if so desired, the **left spin-LED** (intermediate spin) will light up together with the cycle-LED.

- Functioning of the spin-LED's during intermediate spin:

LED	drain/distribution	low spin	coast
Interm. spin	blinking rapidly	continuously	continuously

- Functioning of the spin-LED's during gentle-intermediate spin:

LED	drain/distribution	low spin	coast
Interm. spin	blinking rapidly	blinking slowly	blinking slowly

During final spin, both the left spin-LED (intermediate spin) will light up together with the right spin-LED.

- Functioning of the spin-LED's during final spin:

LED	drain/distribution	low spin	high spin	coast	tumble
Interm. spin	blinking rapidly	continuously	slowly	continuously	off
Final spin	continuously	continuously	slowly	continuously	rapidly

- Functioning of the spin-LED's during gentle-final spin:

LED	drain/distribution	low spin	high spin	coast	tumble
Interm. spin	blinking rapidly	slowly	----	slowly	off
Final spin	continuously	continuously	----	continuously	rapidly

End of a program

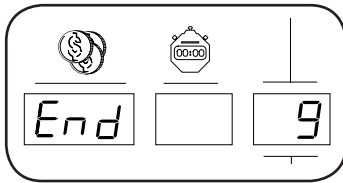

At the end of a program, while the door is being released, the left display shows *End* and the *Start-LED* is switched off. After that only the right display will continue to show the program number. This is the end of the program.

Remarks

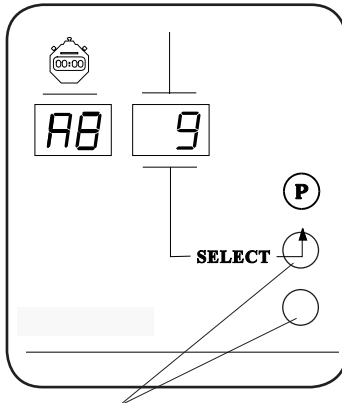

Hidden buttons

Rapid advance

This function allows to skip the rest or certain segments of the program. This function has to *be specified during preprogramming* and is mostly used by technicians and maintenance personnel.

Selection

Push the SELECT-button (P) at the time the special function needs to be activated and *keep the button depressed*.

Now push the upper hidden button *simultaneously and release same. Only now* release the SELECT-button (P).

The central display now shows *F5* and this *function is now active*.

Operation

By pressing and releasing the *lower hidden button* and releasing it again, the programs skips to the next segment (if necessary, the program can be advanced to the end).

To return to the original wash program, press the *upper hidden button*.

Attention!

If F5 is activated during final spin, this segment of the program will be skipped as described above. It is however followed by a coast and tumble time to disentangle the linen. This special function prevents the user from opening the machine while the drum is still rotating and represents an important safety feature.

Premature ending of the program

By using the *rapid advance function* during the program, a program can be prematurely ended. When the end of a program is reached using this function, and as long as the water has not reached the safety level, the door will remain sealed and the display will show "*SLE*" (Safety Level) on the *left display*. Afterwards the display will temporarily show "*End*" on the same display. After that only the right display will continue to show the program number. This is the end of the program.

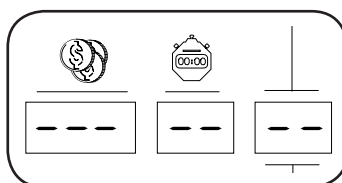
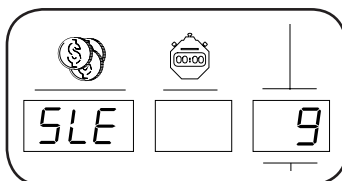

Remark:

If any attempt is made to interrupt the program prematurely *during a spin phase* of the program, all functions on the display will be temporary replaced by blinking *horizontal dashes*. After that only the right display will continue to show the program number and the door will be released. This is the end of the program.

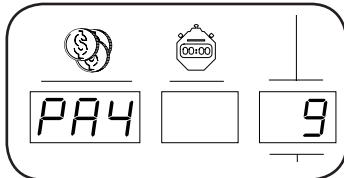
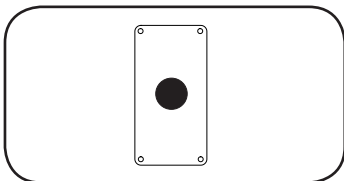
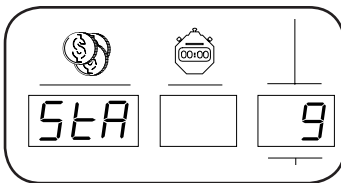
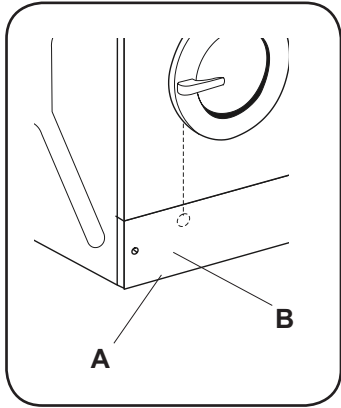
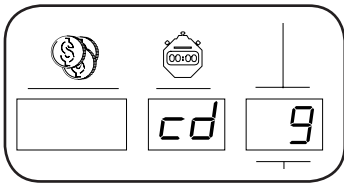

Cool down

This function allows to gradually lower the temperature of the wash bath to prevent creasing of the linen.

During a cool down, the remaining program time on the central display will be replaced by “cd”.

Power Failure

Should the power fall out during the program, the water will be drained and the door can be opened after maximum 3 minutes. When the door remains locked, and the power comes back up within 24 hours, the program will continue from there, where it was at the time of the power failure.

If due to breakdown, the door is not unlocked automatically, you have to remove the service panel (A) below and pull the ring (B), suspended on the left side, while opening the door.

Important:

Before opening the door, check that all the water has been drained from the tub and that the cylinder has come to a complete stop.

Central panel control (Option)

Here payment is done through *the central panel and not directly into the machine*. As soon as the payment is done, and a machine has been selected normally, “*STA*” appears *blinking on the left display*. The machine can be started by pressing the *START button or the special START button*, which has been built in on the spot of the coin meter (option).

Remark :

This option can only be used, when it has actually been programmed as such in the programming.(REMOTE START).

For certain versions, PAY can appear on the left display when this operation is not active.

Therefore, “Remote PAY” was programmed in the programming.

Setting the price

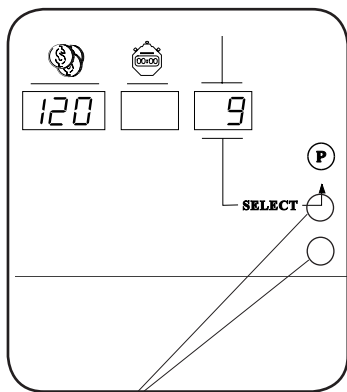
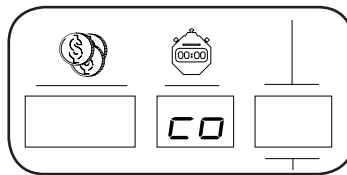
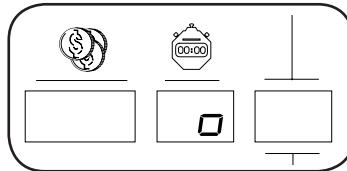
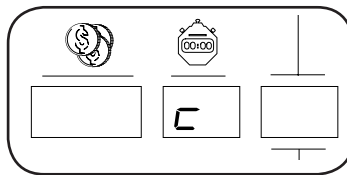
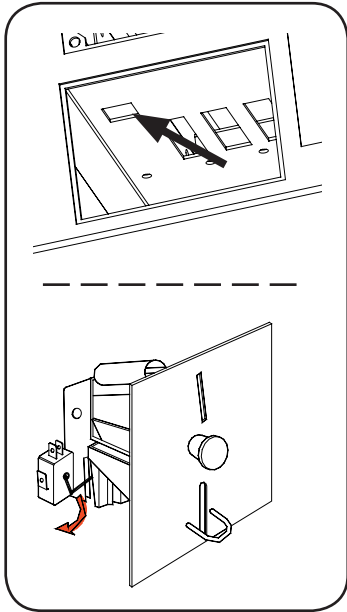

Hidden but-

The price is set according to the specifications at the time of ordering the machine. If no prices were specified, some standard amounts have been preset. Every program can be priced differently. These prices can also be modified easily.

Accessing the price setting mode

Remove the coin box from its house. Certain machines have a press button inside the coin box house at the left upper part. Access to the price setting mode is obtained using this button.

If there is no press button, remove the top panel of the machine.

At the back of the coin meter, a switch-lever can be found. Access is obtained using this switch-lever.

If the machine is equipped with a double coin meter, access is obtained using the **left switch-lever**.

Press the button or pull the switch-lever down for 5 seconds.

The central display will show the letter “c”. Release the button or switch .

When the letter “o” appears on the display, press the button or pull the switch-lever back down again for **5 seconds**.

Now the display will show the letters “co”. From now on the price can be set.

Setting the prices

The right display will show the program number “0”, while the left display will show **the price** for this program.

To **increase** the price: push the **upper** hidden button.

To **decrease** the price: push the **lower** hidden button.

When the price has been adjusted to requirements and no more adjustments are necessary to this program price, press the SELECT-button (P) again. The machine moves automatically onto the next program.

Repeat the previous actions if the price of this program has to be modified as well. When all program prices have been properly set, exit the price setting mode by pressing the button or pushing the coin meter switch-lever back down again once more.

After programming the price for the last program, there are still the following parameters :

A : Eco - price

This is the decrease in value of the price for economical wash. In other words, the amount that the customer is saving by using economic wash.

B : Number of coin insertions COIN 1 (up to 60.000)

This parameter is only indicated if it has been programmed as such in the programming (COIN COUNT).

C : Number of coin insertions COIN 2 (up to 60.000)

This parameter is only indicated if it has been programmed as such in the programming (COIN COUNT).

D : Info manufacturer or technician

TMP T/N : Info manufacturer or technician.

Here you can program the temperature to appear on display in case this has not been done at the programming.

When all desired programs are provided with the right price, end the operation by pressing the push button or pulling over the coin meter switch-lever.

Standard programs

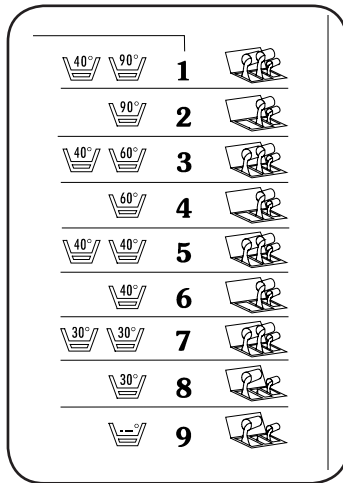

The machine is standard equipped with 10 programs (0+9). These have been designed in cooperation with specialized detergent manufacturers to obtain the best possible wash results using the most frequently used detergents.

Program 0 (starching) is mostly used in very special applications and is therefore not displayed on the front panel.

0. Starching	1 RINSE	COLD
1. HOT WASH	2 BATHS	40°/90°C
2. HOT WASH	1 BATH	90°C
3. COLOUREDS	2 BATHS	40°/60°
4. COLOUREDS	1 BATH	60°C
5. SYNTHETICS	2 BATHS	40°/40°C
6. SYNTHETICS	1 BATH	40°C
7. WOOL	2 BATHS	30°/30°C
8. WOOL	1 BATH	30°
9. CURTAINS	1 BATH	COLD

Technical remarks

Internal connections of the electrical heating

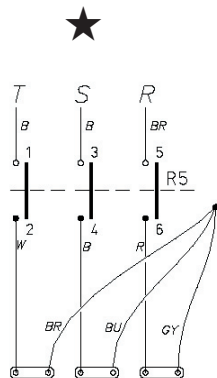
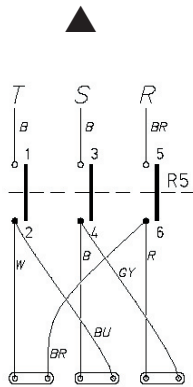

Heating		3x220V	R5	3x380V	R5
9kw	3x3kw	▲	LC1D1810	★	LC1D0901
12kw	3x2kw 3x2kw	▲	LC1D253	★	LC1D0901
15kw	3x2kw 3x3kw	▲	LC1D253	★	LC1D1810
18kw	3x3kw 3x3kw	▲	LC1D323	★	LC1D1810
21kw	3x3kw 3x4kw	-----	-----	★ ▲	LC1D1810 LC1D1810
24kw	3x4kw 3x4kw	-----	-----	▲ ▲	LC1D1810 LC1D1810

B = Black
 Gy = Grey
 R = Red
 PU = Purple
 Br = Brown
 Bu = Blue
 W = White
 W/B = White/black

Remark:

Other executions are available as options

Tilt switch

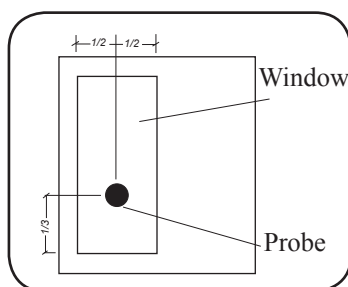

The tilt switch is mounted on the solid part of the machine. There is a window around the probe of the tilt switch that is mounted on the movable part of the machine.

When the machine goes out of balance by overloading or uneven distribution of the linen, the tilt switch will interrupt this action to prevent damage to the machine.

Important

To guarantee good functioning, the probe should be centered horizontally and vertically at 1/3 from the bottom of the tilt window (when machine drum is empty)

Error messages

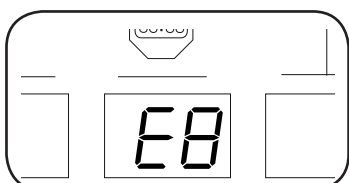
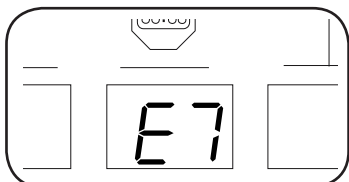
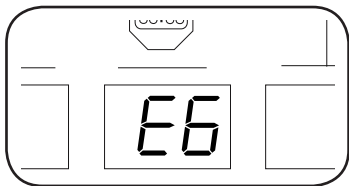
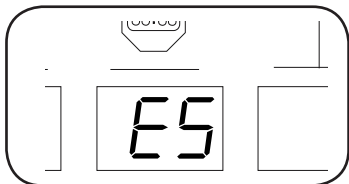
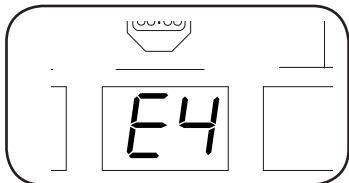
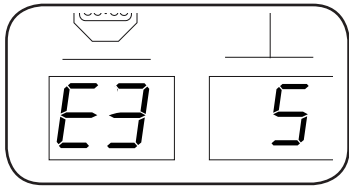
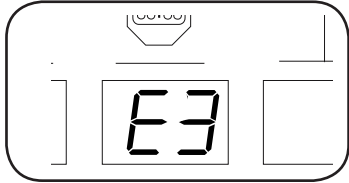

When one of the following malfunctions occurs during a program, the central display will communicate the appropriate error message at the end of the cycle.

E3 (Eprom)

The Eprom is wrong, replace it by another.

Nota:

For coin op machines, it is possible that a program number appears on the right display in combination with E3.

This indicates a wrong price adjustment for this program. A coin value “0” or bigger than “1000” was programmed.

Example : wrong price adjustment for program 5.

E4 (Nivel de agua)

El nivel de agua requerido no ha sido todavía alcanzado después de 15 minutos.

E5 (Calentamiento)

El lavado de limpieza no ha alcanzado todavía la temperatura requerida después de 80 minutos.

E6 (Bloqueo de la puerta de carga)

La puerta de carga se ha desbloqueado durante el programa.

E7 (Nivel de seguridad)

El agua no ha sido suficientemente evacuada, no ha habido centrifugado y el agua está probablemente todavía en la cuba.

E8 (temperature sensor)

The temperature sensor is probably broken or malfunctioning.

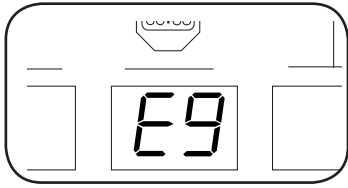
**E9 (motor protection)**

The thermo-magnetic protection was activated 5 times.

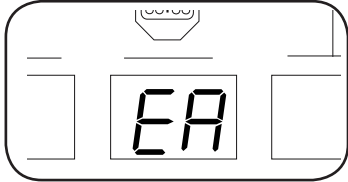
**EA (tilt)**

The tilt switch was activated 15 times during final spin and the final spin was therefore skipped.

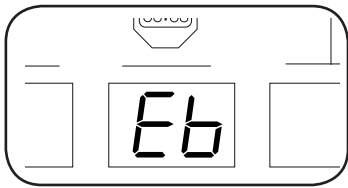
**Eb (tilt switch)**

The tilt switch is blocked.

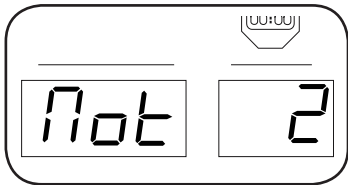
**Mot 2 (rotation sensor)**

The speed detection is not operating properly. The speed meter is probably out of order or disconnected.

Remark

When a malfunction occurs during a program, the central display will communicate the appropriate error message at the end of the cycle. When this malfunction *has been removed and a new program has been selected, this error message also disappears.*

When malfunctions *E3, E6, E7, E9* or *Eb* are detected *at the start of the wash cycle*, the program will *not be started* and *the error message will remain on the display.*

Maintenance of the machine

General maintenance

- Clean the entire cabinet of the machine regularly and remove all traces of soap, etc....
 - Remove all detergent residue in the soap dispenser with hot water.
 - Clean the door gasket and remove all detergents and other products.
 - Shut off the main water, steam and power connections at the end of each day. Do not change the setting of the water inlet taps on boiler fed machines once these have been installed.
 - It is recommended to leave the door and the soap dispenser open after use, to ventilate the machine.
-

Periodical maintenance

- The V-belts of the motors should be retightened after two to three months when first used. This is necessary because these belts are subject to a one-time stretching when first used. **By ignoring this instruction**, the belt starts to slip after a few months and will brake shortly afterwards.
- Check regularly if the filters of the water inlet are not blocked by calcification.
- If a machine frequently skips the final spin, check whether the probe of the out of balance switch is still in the appropriate position, that is horizontally centered and vertically 1/3 from the bottom inside the window. (When the drum is empty). (See electronic repetition system).
- An obstructed drain can cause frequent interruption of spinning for safety reasons.

Repair and after-sales service

In case of important malfunctions and deficiencies which you cannot resolve yourself, do not hesitate to contact the technical service of your distributor.

Data distributor: Name:
Address:
Tel.:

Data machine: Type:.....
Program:.....
Date of installation:.....
Installed by:
Serial number:
Operation voltage and frequency:

The manufacturer reserves the right to change the content of this instruction manual, at all times and without previous notice.