

BOSCH

洗衣干衣机使用及安装说明书

Operating and Installation Instructions



在使用本产品前，请您仔细阅读本使用说明书。

由于不遵守该使用及安装说明书中规定的注意事项，所引起的任何故障和损失均不在厂家的保修范围内，厂家亦不承担任何相关责任。请妥善保管好所有文件。如有疑问，请与当地的客户服务中心或经销商联系。

如果您需要英文说明书，请发送电子邮件，或拨打服务热线向客户服务部门免费索取。谢谢！

Please read this specification carefully before you use the product.

Any failure and losses caused by ignoring the above mentioned items and cautions mentioned in the operation and installation instruction are not covered by our warranty and any liability. Please keep all documents in a safety place for future reference. If you have any doubt, please contact our local service center of dealer.

If you need an English user manual, please send the E-mail to service department, or you can call up service hot line for free supply. Thanks!

生产厂家：中德合资 博西威家用电器有限公司
厂 址：中国江苏省无锡市高新技术开发区旺庄路66号
邮 编：214028

Operating Instructions	Disposal Information.	2
	Environmental Protection/Conservation Issues.	2
	Safety Precautions and Warnings.	3
	Product Standard.	4
	Your New Washing Machine.	5
	First Wash Cycle.	12
	Preparing, Sorting and Loading the Laundry.	12
	Laundry Detergents and Additives.	17
	Washing/drying with standard settings.	18
	Washing/drying with individual settings.	22
	Programme table.	26
	When the Programme has Ended.	28
	Cleaning and Care.	29
Troubleshooting Minor Faults.	33	

Installation Instructions	Installation, Connection and Transport.	36
----------------------------------	---	----

Technical Data & Package Sheet	Technical Data.	43
	Package Sheet.	43

Customer Service	Warranty.	44
	Service Assurance	45
	Warranty Card.	46

Disposal Information

The new machine's packaging

Dispose of packing materials in a responsible manner. Keep packing materials out of the reach of children. Packing materials are not toys. Reprocessing and re-using materials saves raw materials and reduces waste. All packing materials used are environment friendly and re-usable. Cardboard boxes consist of 80% to 100% recycled paper. Plastic wrappings are made from polythene(PE), the tapes are made from polypropylene(PP) and the CC-free packing is made from foamed polystyrene (PS). These materials are pure hydrocarbon compounds and can be recycled.

Your old machine

Render the washer-dryer inoperable when it can no longer be used. Remove the plug from the socket and cut off the power cable. Destroy the catch on the porthole door. Prevent children at play from being locked in and risking death by suffocation. The old machine contains valuable materials which should be recycled. Please make your contribution to the environment by assisting with proper disposal or recycling.

Environmental Protection

Through the economical use of energy, water and detergent, your appliance is kind to the environments as well as your household budget.

You can increase the economy and environmental friendliness of your washer-dryer by washing maximum loads:

refer to page 26 program table

■ How to save energy:

For small amounts of laundry, the automatic control system reduces the consumption of both water and energy. Where possible, use the "60 Cottons/coloureds" program with additional function "Intensive Stains" instead of the "90 Cottons/coloureds" programme. The extended washing duration means that a cleaning result comparable to that of the 90 programme is achieved using considerably less energy.

■ How to save water, energy and detergent:

Avoid using the Pre-wash function when washing lightly normally soiled laundry.

■ How to save energy and time:

For lightly soiled laundry, select the short program appropriate to the type of textile.

■ How to save detergent:

Add detergent according to the degree of soiling, amount of laundry and water hardness, and observe the detergent manufacturer's instructions.

■ How to save energy

If washing is then to be dried in the appliance, select the higher spin speed - because the more water that is spun out of the appliance, the less time and energy is required to dry it.

Precautions and Warnings

Before using for the first time:

- Please read the enclosed documents carefully before using the Washer-dryer for the first time. They contain important information on the installation, use and safety of the machine.
- The manufacturer does not accept liability if these instructions are not followed.
- Please contact an authorized technician to install the machine and instruct the using method.
- Please keep all documents in a safe place for future reference.
- Install the Washer-dryer in accordance with the instructions (page 36-42). Remove the transit bolts and keep them in a safe place.
- The washing machine must be installed and operated in a room with the drain.
- When heating, the maximum current of the washing machine is 10A, so please make sure that the power supply system (voltage; current and the cable) is applicable to the load of the applied appliance.
- In order to ensure your safety, you must plug the cable into a socket which connected to earth. And please check your socket to make sure that it is connected with reliable earth correctly.
- If the Washer-dryer is visibly damaged, do not connect it up. If you are in doubt, contact your customer service representative or dealer.
- This Washer-dryer use thread connection water inlet hose, connect it to the water tap together with the machine according to the require of page 35. (carry out by an authorized technician)

When washing and drying:

- Operate the Washer-dryer with cold tap water only.
- Your Washer-dryer is designed for domestic use only, i.e. For washing machine-washable textiles in a detergent solution.
- Due to the use of the condensation principle in drying, please keep the connected water tap open during the drying process.
- Never use flammable; explosible and/or poisonous solvents such as gasoline; alcohol etc. As the washing lotion. Please only use the lotions suitable for using in washing machine available in the market.
- Never wash the carpet in the washing machine.
- Kepp children and pets away from the washing machine.

- Exercise caution when pumping out hot detergent solution.
- Never open the door when drying.

When the programme has ended:

- When the program has ended:
The End is indicated (If you select no final spin function, see page 28). The buzzer of machine sounds (the duration is 10 minutes) to remind the user that the program has ended. Open the loading door after cutting the power of machine.
- After the programme has ended, please cut the supply of power and water immediately.

Taking care of your machine:

- Do not climb onto the Washer-dryer
- Do not lean against the door.
- Do not expose the Washer-dryer in the place with causticity or explosibility gas. (e.g. dust, steam and gas, etc.)
- Do not install the Washer dryer in a bathroom or a room very wet.
- Please close the door gently. If the door could not be closed successfully, please check if the laundries overload or not balanced.

This series Washer-dryer carry out national standards as following

- **GB/T4288-2003**
Household electric washing machine
- **GB4706.1-1998**
Safety of household and similar electrical appliances.
Part 1: General requirements
- **GB4706.24-2000**
Safety of household and similar electrical appliances
Particular requirements for washing machines
- **GB4706.26-2000**
Safety of household and similar electrical appliances
Particular requirements for spin extractors
- **GB4706.20-2000**
Safety of household and similar electrical appliances
Particular requirements for tumbler dryers

Your new washer-dryer

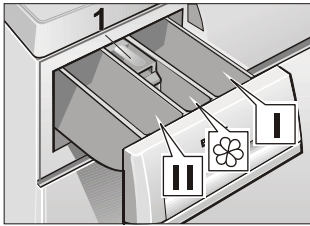

Filling laundry detergent and/or additive dispensers.

Chamber I:
Detergent for pre-wash, starch, or pre-soaking agent.

Chamber II:
Detergent for main washing period, water softener, bleach and stain-removing salt.

Chamber 
Additives, e.g. fabric softener or former (Do not exceed Max)

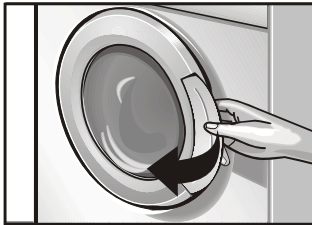

Open the loading door

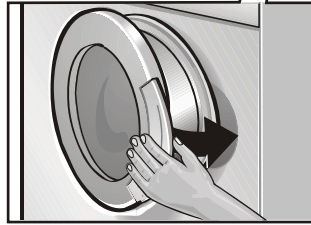

and close it

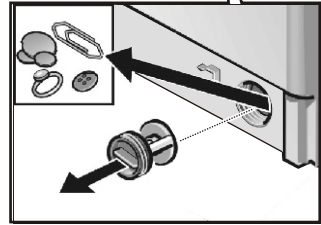

Drain washing solution if necessary.

Control Panel

“Start” button

For starting the wash/dry cycle (programme must have been selected).

Program selector

For switching the washer-dryer on and off and for selecting the programme. Can be rotated in either direction. If rotate it during the washing/drying, the programme will be stopped. The programme sequence is electronically controlled.

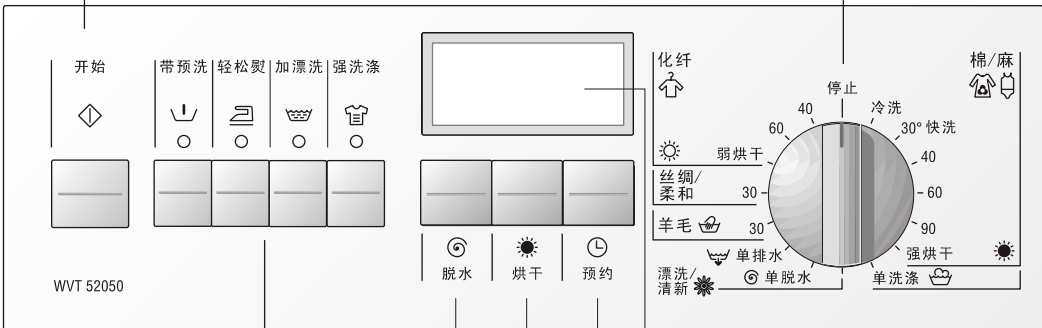

Buttons for additional options

(In addition to the programme if required)

- Intensive Stains: extend the washing duration
- Extra Rinse: additional rinsing cycle
- Less Ironing: gentle spin
- Prewash: actuate prewash

Additional options can be combined.

The indicator lights of the buttons come on if the additional options are active.

Switching off the additional option: Press the button again. Indicator light goes out.

Display pannel

Indicates the settings which have been selected(e.g. Spin speed, Time delay, Childproof lock, Maximum load)

Button

Selects the start time(delays the start of the programme).

Button

Select the drying time

Button

Selects the spin speed or no final spin.

Display panel

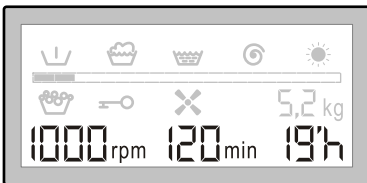
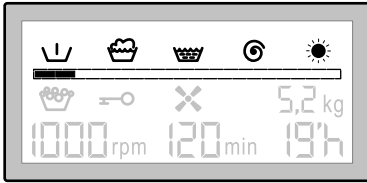

Display	Notes
Prewash	On if selected
Washing	Not on if rinse, spin or drain additional programme was selected
Rinse	Not on if spin or drain additional programme was selected
Final spin/Empty	Not on if a programme with the '---' setting (without final spin)
Drying	Not on if dry programme or dry time was selected
Progress bar	For the programme status
Overdosage	On if too much detergent dispensed
Childproof lock	On if selected
Fan	Not on if dry programme or dry time was selected
5,2kg* Maximum load	Not on if rinse, spin or drain additional programme was selected
1000* Spin speed or ---* no final spin	Maximum spin speed of the programme or selected speed
120 min* Drying time	Selected drying time
19h* Start time	Selected start time
Other displays at this location:	
1:00*	Programme duration Expected programme duration
End	End of programme or
---	End of programme without final spin or
E02*	Fault display See page 33

* Examples of the display, it will be changed according to your selected program.

Programme status display

The first row of symbols and the progress bar below form the programme status display. The progress bar consists of a frame and several segments.

When the programme has been selected, the symbols for the individual programme sections are displayed. The frame of the progress bar flashes and requests the programme to start.



When the programme has started, the almost empty bar is displayed which fills up with segments from left to right while the programme is running. The symbols indicate the programme sections which have not yet run and go out when the particular programme section has run.

At the end of the programme all symbols have gone out and the progress bar is full.

Overdosage

The automatic safety system detects excessive froth in the appliance due to a highly frothing detergent or an overdosage. At the end of the programme this is indicated in the display field by the  symbol. Dispense less detergent for the next wash with similar items of washing (same degree of soiling and wash load).

Overdosage of detergent may cause excessive froth formation and impair the washing and rinsing results. A rinse cycle is automatically run.

 The  symbol goes out when the appliance switches off at the end of the program or if the programme is changed.

Childproof lock

The activated childproof lock prevents the selected programme from being changed while the programme is running, see page 23.

 The fan works at the last 10 minutes of drying duration for cooling the laundry.

 Do not interrupt this cooling process.

Maximum load

The maximum wash/dry load is displayed depending on the selected programme and additional functions, see page 26.

Spin speed

The maximum spin speed is displayed depending on the selected programme and additional functions.

Program maximum spin speed (rpm) model	cottons	easy-care	delicates	wool	washing	rinsing	spinning
WVT52050	1000	800	600	800	800	800	800
WVT52458	1200	800	600	800	800	800	800

Programme duration

When the programme has been selected, the expected programme duration (time after which the programme is expected to end) is displayed.

The programme duration is displayed in hours and minutes, e.g. 01:17 — 1 hour and 17 minutes

00:35 — 35 minutes.

When the programme has started, the colon : flashes between hours and minutes and the programme duration counts down in minutes.

When the programme ends, the displays shows *End* (if select no final spin function, see page 28).

 While the programme is running, the programme duration may be extended or reduced for the following reasons.

Reductions in time occur because of :

- small loads,
- reduced heating times, e.g. If the water is very hot.
-

Increases in time occur because of:

- additional rinse cycle if excessive foam is in the laundry,
- multiple spinning if the laundry is distributed poorly in the drum,
- increased heating times, e.g. When the water is too cold,
- water pressure too low,
- selection of an additional option, e.g. Intensive Stains function after the programme has started.
- Very absorbent washing extends the heating duration.
-

Start time

You can delay the start time, see page 22

Drying duration

- You can set the drying duration.
- When the washing and drying without a break was selected, drying duration will add in programme duration automatically. Cotton quick washing programmes will prolong 10 minutes and other cotton programmes will prolong 5 minutes for good washing performance.

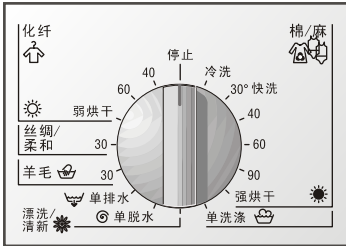

■ Basic programme

Select the desired programme (refer also to “Programme table”).

Cold, 40 Cottons/coloureds
For hard-wearing fabrics.

30 quick washing Cottons/coloureds
For less soiling fabrics made from cottons or linen. This duration is shorter.

60 Cottons/coloureds
For very dirty, hard-wearing fabrics.
Select this programme can remove stain as protein and so on.

90 Cottons/coloureds
An energy-intensive program for heat-resistant fabrics made from cotton or linen.

For the protection of the drainage pipe, the hot washing solution is mixed with approx. 5 liters of cold water before being drained.

Intensive dry
For cottons/coloured textiles, dry at normal heat setting.

Cold, 40, 60 Easy-care
For easy-care fabrics made from cotton, synthetics or blend-ed fibres.

Gentle dry
For easy-care textiles, dry at low heat setting.

30 Delicates
For sensitive, easy-care fabrics made from cotton, synthetics or blended fibres, and net curtain. No spinning between rinsing cycles.

Cold, 30 Wool 
For hand or machine-washable fabrics made from wool or wool blend.

■ Additional function

Washing

Separate washing cycle.

Rinsing

Separate rinsing cycle with subsequent spin cycle for easy care fabrics.

Spin

Separate spin cycle. Washing solution or rinsing water is drained prior to the spin cycle.

Drain

Draining of the rinsing water after a wash programme with the without drain setting for the gentle treatment of delicate laundry.



■ Additional function

(You can select an additional function if necessary)

■ Intensive stains

For very dirty clothes, the washing duration will be prolonged 20 to 60 minutes after pressing this button, and this is decided by the programme that you selected.

■ Extra rinse

An additional rinsing cycle performed; the washing duration will be prolonged 10 minutes.

■ Less Ironing

Special spin cycle with post-spin loosening cycle. The laundry is left lying loosely in the drum, thus reducing creasing. After pressing this button, the washing duration and max spin speed will be changed.

	cottons		Easy -care	delicates	wool	rinsing	spinning
	30	others					
washing prolonged time	10 min	5 min	5 min	5 min	no	5 min	5 min
maximum spin speed	800rpm		600rpm				

■ Prewash

For very dirty fabrics, washing duration will be prolonged 20 minutes.

Observe the maximum load for each type of fabric;
Remove the laundry immediately after the spin cycle.

First Wash Cycle

The installation of the washer-dryer is finished.
(See page 36-42)

Each washer-dryer has been tested in the factory. A little bit of water can be left in the drum during the test. Please carry out the first wash cycle without laundry to remove any water left over from the factory tests.

- Do not load any laundry.
- Turn the tape ON.
- Pull the detergent drawer out as far as it will go.
- Input about 1 liter of water in chamber II.
- Pour half a measuring cup of detergent into chamber II.



Do not use a special detergent for delicates or wollens as these will create too much foam.

- Close the detergent drawer.
- Close the washer-dryer door.
- Turn the programme selector to 90 Cottons/coloureds.

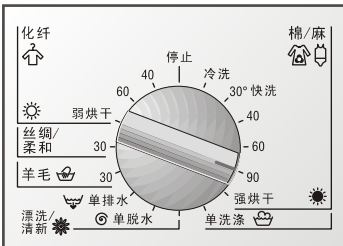

- Press the “Start” button. The washing program starts.
- The programme ends when all symbols in the upper row of the display field go out, the progress bar is completely filled and the programme duration is on *End*, the buzzer sounds.
- Turn the programme selector to off position.

Preparing/sorting and loading the laundry

Preparing the laundry

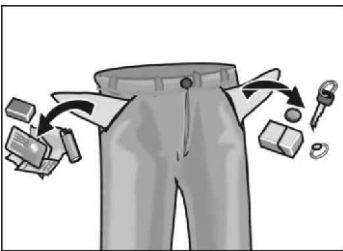

- Remove any loose items or metal objects, such as safety pins, paper clips, etc. from the laundry.
- Brush sand, coins, etc. out of pocket and cuffs.
- Close zips and button up cushion covers, duvet covers, etc.
- Remove curtain runners, or secure them in a net bag.
- Particularly delicate items, such as tights or lace curtains, or smaller items, such as tiny socks or handkerchiefs, should only be washed in a net bag or pillow case.
- Some items are best turned inside out. These included knitwear, trousers, T-shirts and sweatshirts.

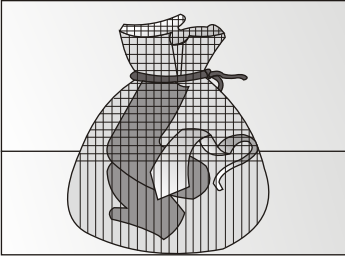

- Make sure that the wire-cup bras are machine washable.

Make sure that wire-cup bras in a pillow case which can be securely closed with a zip or buttons. If the wire works itself out of the cup it may fall through the holes of the drum and cause extensive damage.

Preparing laundry for drying

- Only tumble-dry textiles which have been washed, rinsed and spun.
- Remove as much water as possible from the laundry. Do not press the button for reducing the spin speed.
- Before tumble-drying, ease-care items should also be spun using the appropriate spin programme (see programme table)
- In order to ensure uniform drying, sort the items according to fabric type and degree of drying required.
- Easy-care items should if possible be removed from the washer-dryer while still slightly damp and allowed to continue drying in the open air. Overdrying may cause excessive creasing.
- Items which require ironing do not have to be ironed immediately after being tumble-dried. It is a good idea to fold or roll them together for a while, so that any remaining moisture is evenly distributed.

Sorting the laundry

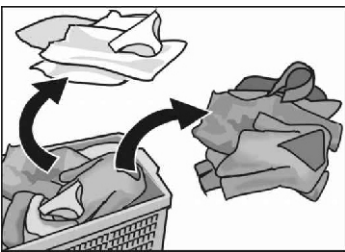

Degree of dirt

Sorting the laundry

- According to colour and degree of dirt

Caution

Items of clothing can become discoloured. Never wash new multi-coloured items together with other items.

White items may become grey. Always wash white and coloured items separately.

Slight dirt

No recognizable dirt or staining. Laundry may have some body odour.

- Light summer clothing and sportswear that has only been worn for a few hours.
- T-shirts, shirts and blouses that have been used for one day.
- Bed linen and guest towels that have been used for one day.

Normal dirt

Visible dirt and/or some light staining recognizable.

- T-shirts, shirts and blouses that are very sweaty or have been worn several times.
- Underwear that has been worn for one day.
- Tea towels, hand towels and bed linen that have been used for up to one week.
- Net curtains (without nicotine staining) that have not been washed for up to 1/2 year.

Intensive dirt

Dirt and/or staining recognizable.

- Kitchen hand towels that have been used for up to one week.
- Fabric napkins.
- Children's outer clothing or football shirts and shorts with grass and soil stains.
- working clothes such as overalls or baker's and butcher's coats.

Typical stains

- Skin fat, cooking oils/fat, sauces, mineral oil, wax(containing fat/oil)
- Tea, coffee, red wine, fruit, vegetables(bleachable).
- Blood, egg, milk, starch(containing protein/carbohydrate).
- Soot, soil, sand(pigments), red sand on tennis clothes.

Removing stains

Wherever possible, remove/pretreat stains whilst they are still fresh. First, dab soapy water onto the stain. Do not rub. Subsequently wash the items of clothing using the appropriate program. Several washing cycles may sometimes be required in order to remove stubborn/dried in stains.

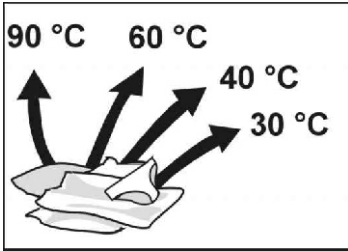

■ **Sorting laundry according to their care label specifications**

Only wash laundry that is labelled with the following care symbols:



90 Cottons + lines



60 , 40 , 30 Cottons + lines



60 , 40 , 30 Easy-care



40 , 30 Delicates



40 , 30 Wollens (hand and machine-washable)

Laundry that is labelled with the following care symbol must not be washed in the washing machine.

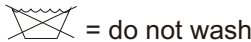

Only dry laundry that is labelled with the following care symbols

☉ =Tumble-dry at normal heat setting (intensive dry)

☉ =Tumble-dry at low heat setting (gentle dry)

The following textiles should not be tumble-dried:

Laundry marked with the care symbol:

☒ =Do not tumble-dry

- Wollens or items containing wool. **Risk of shrinking!**
- Delicate fabric (silk, synthetic net curtains). **Risk of creasing.**
- Items containing foam rubber or similar material.
- Items which have been treated with inflammable solvents, such as stain removes, petrol, paint thinners. **Explosion hazard!**
- Items still containing hair lacquer or similar substances. **Dangerous vapors!**
- Dripping-wet laundry. **Waste of energy!**

Loading the laundry

⚠ Risk of explosion

Items of clothing that have been pretreated with solvent-based cleaning agents, e.g. Stain remover and dry cleaning spirit, represent an explosion hazard once loaded into the washer-dryer.

Therefore, these items must be rinsed thoroughly by hand.

Risk of explosion

Loose debris in the washer-dryer drum can damage the laundry. Before loading the laundry, check that there is no debris in the drum.



- Open the loading door.

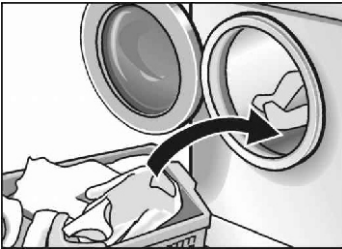

- Unfold the sorted items of clothing and place them loosely into the drum. Mix up large and small items. Items of varying size will distribute better during the spin cycle..
- Do not exceed the maximum load: Overloading will cause poor wash/dry results and encourage creasing.
- When washing/drying a small amount of laundry, the washer-dryer automatically reduces the amount of the water and energy used.

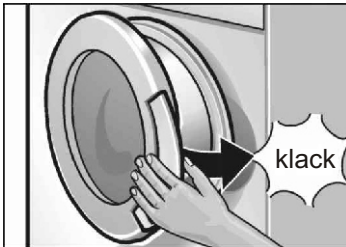

- Close the loading door.
Take care not to trap any items of clothing between the loading door and rubber seal.

Laundry Detergents and Additives

Risk of explosion

- Do not use solvent-based cleaning agents in fully automatic washer-dryer. **Explosion hazard.**
- Keep detergents and additives out of the reach of children.

You can use any standard powder or liquid detergent which is suitable for automatic washer-dryer. Do not use any detergent boosters containing solvents or dirt and stain-removing spraying near the machine, as these could damage the machine. Do not use non-automatic detergent as these produce too much foam.

Amount of detergent

The best washing results will only be achieved if you add the correct amount of detergent. Observe the instructions for use shown on the detergent packaging.

When using liquid detergents, you can use any measuring aids provided with the detergent, such as dosage balls or bags.

Please put the liquid detergents into correct chamber.

The amount of detergent depends on:

- water hardness
- degree of soiling
- size of load
- amount of detergent to be added according to its manufacturer.

Dispensing the correct amount of detergent relieves the strain on the environment and ensures optimum washing results.

Frequent use of insufficient detergent will eventually become noticeable as followings:

- washing appears grey or not properly clean
- grey-brown stains (grease marks) form on the washing

Too much detergent results in:

- unnecessarily high environmental pollution
- due to the generation of too much foam, the washing is hardly agitated which leads to poor washing results.

The amount of detergent indicated on its packaging refers to a full machine load.

For small loads or less soiling, reduce the amount of detergent.

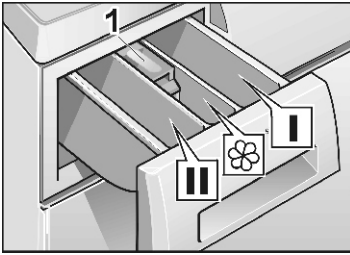

Filling laundry detergent and/or additive dispensers

- Do not fill beyond the "Max" mark, otherwise will be flushed into the machine together with the detergent at the start of the program.

- If the liquid additive is thick, mix with a little water before dispensing (prevents clogging of the overflow).

- Pull out the detergent dispenser up to the end stop.
- Add the detergent and/or additive.
- Close the detergent dispenser.

Washing/drying with standard settings

Your washer-dryer can be used in three ways:

- washing only,
- drying only,
- washing and drying without a break in between.

Caution:

For interrupted washing and drying, the maximum load must be reduced to 2.6kg for cottons/coloureds or 1.5kg for easy-care. Furthermore, it is possible that certain types of laundry will not be dried satisfactorily using the non-stop mode.

The economic using way: wash and dry with recommended loads.

Setting the washing programme or washing and drying without interruption

(Example of easy-care 40°C programme)



1. Turn the tap ON.

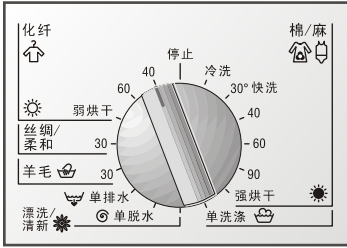

2. Turn the programme selector to the desired programme (see programme sheet, page 26).

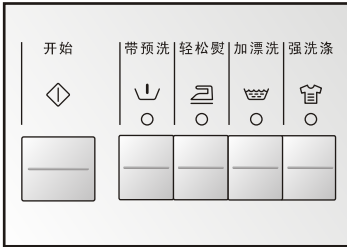

3. If required, press the button(s) for additional option(s). The indicator light of the selected button is on.



4. The frame of the progress bar flashes in the display field and the following is displayed for the selected programme:

- the symbols for the programme sections,
- recommended load,
- maximum spin speed,
- drying duration (displays 0 min, if the laundry needs to be dried, please refer to setting the drying time),
- programme duration.

- Load the laundry and close the loading door. Do not exceed recommended loads.

If you do not need your laundry to be dried immediately in the machine after the washing programme, please read the instructions for starting the programme. Otherwise, please set the drying time according to the instructions.

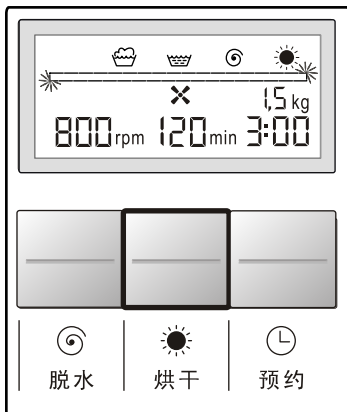

5. Press the ☀ button to set the desired drying time, the programme will be washing and drying without interruption.

- The indicator light of additional function goes out if the additional function is selected, it is not available when a drying cycle comes subsequently.
- The spin speed and programme duration will be changed accordingly after the drying time being setted. See page 9.
- The maximum load is also changed, do not exceed recommended washing/drying loads.

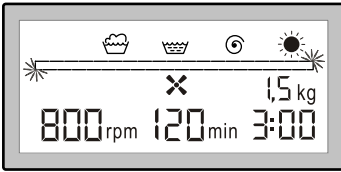

The frame of the progress bar flashes in the display field and the following is displayed for the selected programme:

- the symbols for the programme sections, drying ☀ and fan ✕ ,
- recommended load,
- maximum spin speed,
- drying duration,
- programme duration.

Press the “Start” button. The programme starts.

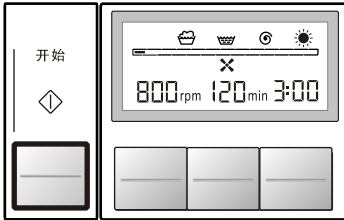

- i** The almost empty progress bar is indicated in the display field. The recommended load goes out. While the programme is running, the programme duration counts down and the progress bar fills up with the segments. The symbols for the run programme sections go out.

Setting the drying programme



1. Turn the tap ON.

Due to the use of the condensation principle in drying, please keep the connected water tap open during the drying process.

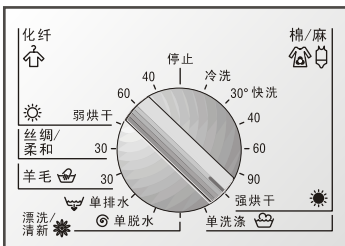

2. Turn the programme selector to the desired programme. (See programme sheet, page 26)

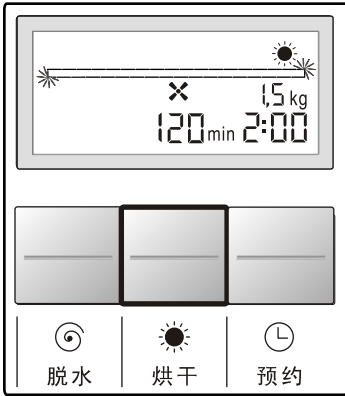

3. Press the ☀ button to set drying time.

The frame of the progress bar flashes in the display field and the following is displayed for the selected programme:

- the symbols for the programme sections, drying ☀ and fan ✕ ,
- recommended drying load,
- drying duration,
- programme duration.

■ Load the laundry and close the loading door. Do not exceed recommended loads.

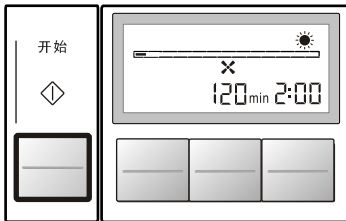

4. Press the "Start" button. The programme starts.

i The almost empty progress bar is indicated in the display field. The recommended load goes out. While the programme is running, the programme duration counts down and the progress bar fills up with the segments. The symbols for the run programme sections go out.

Washing and drying with individual is described subsequently.

Washing/drying with individual settings

You can adjust the setting to your requirements. First find a quick overview of the adjustable settings. The steps for changing the setting are described in detail overleaf.

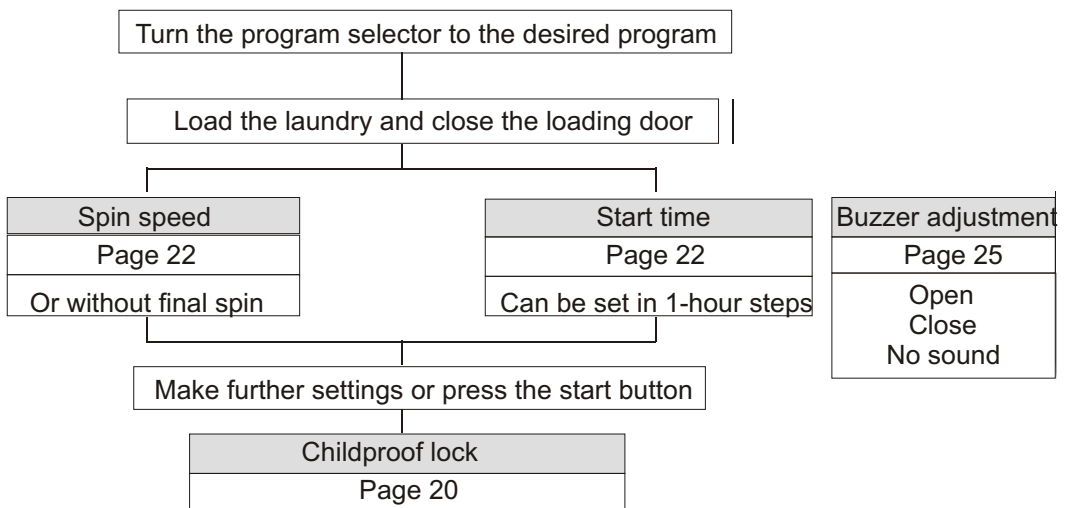

Spin speed

The maximum displayed spin speed depends on the selected programme.

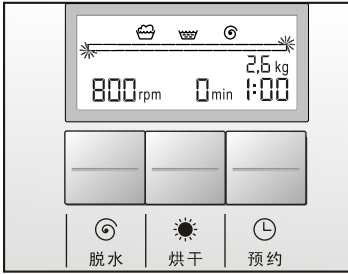

- Press button until the required spin speed.

- i If setting “---” (without final spin) has been selected, the washing remains in the final rinsing water.

Before the laundry can be unloaded, the Empty or Spin programme must be performed. Or pressing button to select the desired spin speed.



- i The spin speed can be changed at any time by pressing the button until the desired speed is displayed. Setting “---” (without final spin) is possible until the Rinse programme section starts.

Start time

Before a programme start, you can specify by how many hours the start of the programme is to be delayed.



- Press the button, '1h' appears in the display. Press the button until the desired number of hours is displayed.

- i The first line of the programme flashed between h and ' .

- i The start time can be set in 1-hour steps. The time can be delayed up to a maximum of 19h. If a start time of 19h has been set, the programme duration time can be accessed by pressing the button again.



- i The time delay is counted down by the hour. When the start time has elapsed, the programme starts automatically and the programme duration is displayed.

- i Changes to the start time or an immediate start are possible. To do This:

- Briefly set the programme selector to another program.
- When the programme selector has been reset to the original programme, individual or all other settings may have to be re-selected. If required, reset the start time.
- Press the “Start” time. The programme starts.

Childproof lock

You can secure your washer dryer to prevent selected functions from being inadvertently changed.

If the childproof lock has been selected:

- No changes can be made while the programme is running.
- The symbol  flashes if a programme setting is inadvertently changed,
- Should the appliance be switched off and on while a programme is running the program will continue at the point at which it was interrupted.

Activating the childproof lock

- Set the programme selector to the required programme. If required, select other settings.
- Load the laundry and close the loading door.
- Press the “Start” button. The programme starts.
-  Release the “Start” button.

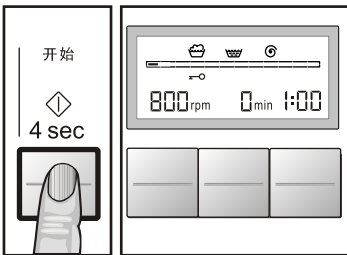

- Press the “Start” button and hold down (for approx. 4 seconds) until the  symbol is displayed.
- Press the “Start” button, the childproof lock is activated, the symbol is permanently on.

The childproof lock must be deactivated before making programme changes or ending programmes with setting “---” (without final spin).

Deactivate the childproof lock

- Press the “Start” button and hold down (for approx. 4 seconds) until the  symbols goes out.

Change a programme

If you have accidentally selected the wrong programme:

- If the childproof lock is active, temporarily deactivate; see page 20
- Turn the programme selector to a newly selected programme. If Prewash is selected subsequently, set the programme selectors to off and reselect the programme.
- If required, change the other settings; see page 18.
- Press the “Start” button. The programme starts.

Cancelling active program

If you wish to prematurely end a programme:

- If the childproof lock is active, deactivate; see page 20.
- Turn the programme selector to Empty or Spin programme. If required, select the desired spin speed (but not setting “ --- ” (without final spin).
- Press the “Start” button.

A pause in active programme

If you want to add/remove the laundry during active programme and the set programme sequence will not be changed.



- Remove the plug from the socket.
- Wait about 2 minutes, open the loading door.
- Add/Remove the laundry
- Reconnect the power supply, the memory function of the washer-dryer will continue the interrupted programme. So, the time in the display field may be different from previous display.
- Also, in the case of power failure or the power is accidentally cut off, after the power supply comes back, the washer-dryer will continue the interrupted programme.

Signal

The acoustic signal indicates:

- that the additional functions (buttons) have been switched on or off,
- Individual programme statuses (e.g. Start of programme, end of programme), operating errors and faults.

Signal for switching buttons on and off

- Press the  button and set the programme selector to cottons/coloureds cold. Hold down the  button until the signal is emitted. The selected setting is stored.
- i** When the additional functions are switched on, a long signal is emitted; when the additional function is switched off, the signal is short. The volume of the signal cannot be changed.

Signal for programme status

The signal can be switched on and off and the volume set before the start or after the end of the programme.

- Press the  button and hold down until the signal is emitted and the volume of the signal changes.
Release the button when the required volume is reached. The selected setting is stored.

Programme table

Always follow the manufacturer's care label instructions		Laundry up to (kg)	Detergent and fabric softener			Additional functions				Programme duration ** in minutes *** (approx. time)	
			Chamber I	Chamber II	Chamber 	Intensive stains	** Extra rinsing	** Less ironing	** Prewash		** Dry
Cottons/ coloured	Cold	5.2	○	●	○	○	○	○	○	○	70(110)*
	30 quick	5.2	○	●	○	○	○	○	○	○	39(59)*
	40 °C	5.2	○	●	○	○	○	○	○	○	80(120)*
	60 °C	5.2	○	●	○	○	○	○	○	○	80(138)*
	90 °C	5.2	○	●	○	○	○	○	○	○	95(135)*
Intensive dry		2.6								○	Max 120min
Easy-care	40 °C	2.6	○	●	○	○	○	○	○	○	60(80)*
	60 °C	2.6	○	●	○	○	○	○	○	○	70(90)*
Gentle dry		1.5								○	Max 120min
Silk	30 °C	2.0	○	●	○	○	○	○	○		35(55)*
Wool	30 °C	2.0		●	○	○	○	○			40(60)*
	washing	3.5		●		○	○				20(40)*
	rinsing				○		○	○			14
	spinning						○	○			8
	draining										1

* Time shown in "()" is the program duration after selecting "Intensive Stains". ● = Obligatory

** After selecting "Extra rinsing" or "Less ironing" or "Prewash", the program duration will prolong, see page 12. ○ = optional

*** The following duration is required when you operate the machine according to the instruction of user manual (page 21 to 26). The display mode is "hour: minute". The duration will be changed according to the program process. If the jumping phenomena is occurred, it is normal.

Programme table: drying

cottons/coloureds (cotton, linen)					
Dry weight in Kg	0.5	1.0	1.5	2.5	
	Drying time selector				
Cupboard dry	50-60	60-70	70-80	90	Intensive dry
Iron	40-50	50-60	60-70	70-80	

Easy-care / synthetics					
Dry weight in Kg	0.5	1.0	1.5		
	Drying time selector				Programme selector
Easy-care	40	50	70		Gentle dry
Acrylics		25	25 - 30		

Times are approximate and refer to standard loads.
The maximum selectable drying time is 120 minutes.

When the Program has ended

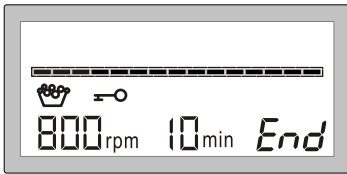

- i** Display panel:
 - All symbols on the programme status display have gone out, the full bar is displayed.
 - The programme duration is on *End*.
 - If the childproof lock is selected, the symbol illuminates.
 - If the detergent was overdosed, the symbol illuminates.
 - Selected spin speed illuminates.
 - If the drying time was selected, the drying time illuminates.
- If required, deactivate the childproof lock.
- Turn the programme selector to off position.

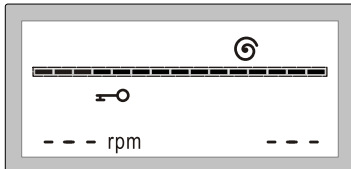
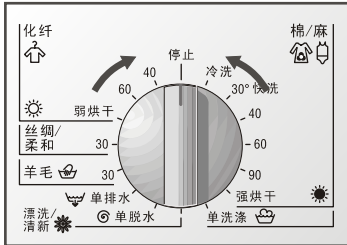

Setting “ - - - ” (without final spin) selected

- i** Display panel:
 - The symbol and the full bar are indicated on the programme status display.
 - The programme duration is on “ - - - ” .
 - If the childproof lock is selected, the symbol illuminates.
- If required, deactivate the childproof lock.
- Select an additional programme Empty or Spin. Or press button to select spin speed.
- Press the start button.
- After Empty or Spin programme ends, if detergent was overdosed, the symbol illuminates.
- Turn the programme selector to off position.



Unloading the laundry

- Turn off the water tap.
- Open the loading door.

If the loading door can not be opened:
Wait for 2 minutes (the safety function is active)
or
there is still water in the washer-dryer if the “ without final spin ” option was selected. In the latter case, select the “Draining” or “Spinning” programme.



- Unload the laundry.

Caution:
Remove any debris (e.g. Coins, paper clips) from the drum and rubber seal---risk of rust formation!

- Leave the loading door open to allow the inside the washing machine to dry out.

After tumble-drying:

- Carry out the loads after drying immediately.

Cottons / coloureds

- Cotton and linen items which have been dried to “iron dry” should be rolled together to prevent them from drying out completely before they are ironed.
- “Cupboard dry” items must be smoothed out and folded up.

Easy-care / synthetics

Hang shirts and blouses on individual hangers.

⚠ Risk of electric shock!

Always disconnect the appliance from the mains before cleaning.

Never clean the washer-dryer with a jet of water.

⚠ Risk of explosion!

Never use solvents to clean the appliance.

Cleaning the appliance housing and control panel

As required:

- Use hot soapy water or a mild, non-abrasive cleaning agent.
- Rub dry with a soft towel.

Cleaning and Care

Cleaning the drum

In the event that rust spots have formed due to leftover debris (e.g. Coins, paper clips, needles, nails):

- Use a chlorine-free cleaning agent. Follow the manufacturer's instructions. Never use steel wool.

Clean the detergent dispenser

In the event that residual detergents or additives have accumulated.

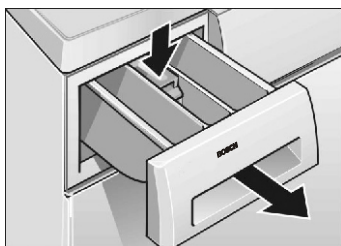

- Pull out the detergent dispenser up to the end stop.
- Press down the hollow on the insert and remove the detergent dispenser completely.

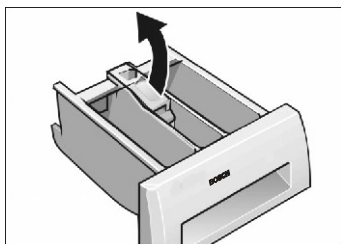

- Pull up the insert.
- Rinse the detergent dispenser under hot running water.

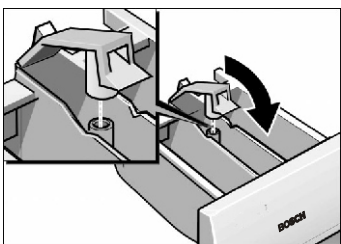

- Push down the insert until it clicks into place.
- Insert the detergent dispenser.

Clean the drain pump

This is necessary if the washing solution can not be completely drained. The pump is blocked by either loose debris or fluff which accumulates if fluff-giving fabrics are washed at high temperature.

Draining the washing solution

The water in the drum should be drained first before cleaning the drain pump. Have a suitable container ready.

Draining the washing solution

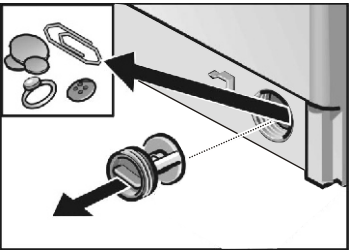
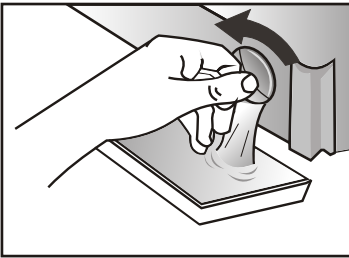
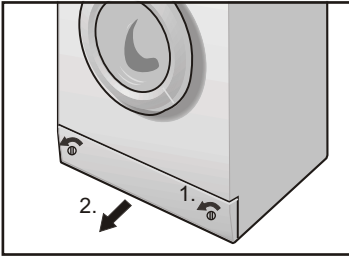

Risk of Scalding

Allow the hot washing solution to cool.

- Turn the programme selector to “Off”.
- Fold down the cover panel.
- Carefully remove the pump cap. But do not fully remove it and allow a little more residual water flow into the suitable container.

- Remove the pump cap.
- Remove any loose debris/fluff from inside the pump and clean the pump. The pump impeller must be able to rotate. Clean any residual suds or fluff from the thread of the pump cap and pump housing.
- Attach and tighten the pump cap.
- Attach and close the cover plate.

To avoid unused detergent from flowing into the drain during the next wash cycle:

- Pour 1 litre of water into chamber II
- Select the “Draining” programme.

Cleaning water inlet strainers

This necessary if very little or no water flows into the washing machine.

First release the water pressure in the supply hose:

- Turn of the water tap.
- Turn the programme selector to any programme. (Except “Spinning” and “Draining”)
- Press the “Start” button, and allow the programme to run for approx.40 seconds.

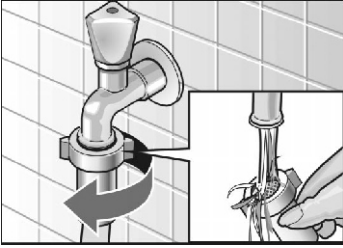

Cleaning the strainer at the water tap

- Disconnect the hose from the water tap.
- Rinse the strainer under flowing water.
- Reconnect the hose.

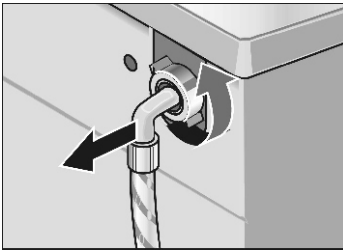

Cleaning the strainer on the washing machine

- Disconnect the hose from the back of the washer-dryer.
- Pull out the strainer and rinse under running water.
- Insert the strainer and reconnect the hose.
- Turn on the water tap and check whether water is still discharged. If water is still discharged, check that the strainer is attached properly.
- Turn off the water tap.

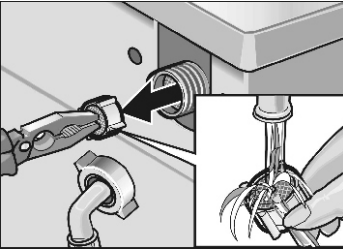

Descaling the washer-dryer

Caution:

Descaling agents contain acids which can attack parts of the washer-dryer and discolour the laundry.

Provided that you use the correct amount of detergent, it is not necessary to descale the washer-dryer.

If, however, descaling the appliance becomes necessary, please follow the instructions provided by the descaling agent manufacturer.

Frost protection

If the washer-dryer is located in a room which is exposed to freezing temperatures, any residual water in both the pump and the water inlet hose must be drained immediately every time the machine is used.

Draining the pump:

See "Cleaning the pump" on page 27,

Draining the water inlet hose:

1. Turn the tap OFF.
2. Unscrew the hose from the tap and hold the end of the hose over a container.
3. Switch ON any of the washing programmes for approximately 40 seconds. Water left inside the inlet hose will be drained out.
4. Screw the hose back onto the tap.

Trouble Shooting Minor Faults

⚠ Risk of electric shock

Repairs must only be carried out by our Customer Service or an authorized technician.

If repairs are needed, and assuming that you cannot eliminate the fault yourself with the aid of the following table:

- Turn the programme selector to Off .
- Disconnect the washer-fryer from the mains.
- Turn off the water tap.
- Call Customer Service.

A signal emitted in display field	Possible cause	Action
E01	Door not closed properly.	Check whether laundry is trapped in door; Close the washer-dryer door.
E02	Tap not turned on. Inlet hose kinked or pinched. Filter blocked in water inlet hose. Water pressure too low.	Turn the tap on. Eliminate cause. Clean filter, see 31. Eliminate cause.
E04	Lose debris is blocking the pump; Drainage pipe blocked	Clean the pump, see page 30; Clean the drainage pipe.

Fault	Possible cause	Action
The washer-dryer door cannot be opened.	There is water in drum.	Select "Draining" or "Spinning" .
	Safety function is active.	Wait for 2 minutes.
Detergent residue in the detergent dispenser.	Detergent was damp or lumpy.	Clean and dry the detergent dispenser(refer to Page 30) Use the dispensing aid for liquid detergent.
The gasket is crimped.	This may appears after installing the transport bolts.	Remove the transport bolts, operate the machine for a period of time, the gasket will return to the original shape.
The belt gets off the pulley.	Too much laundry is in the drum or the laundry is put in badly, and close the window with excessive force.	Put in the laundry well and according to the maximum load specification.

Fault	Possible cause	Action
Control lights do not come on.	A fuse has triggered.	Switch on/replace the fuse. Call Customer Service if this fault is repeated.
	Power failure.	An interrupted program will be resumed when power returns. If you wish to unload the laundry, proceed as in Cleaning the drain pump, Page 30.
	Plug is loose or not inserted.	
The programme does not start.	Loading door not closed.	Check whether laundry is trapped in door. Close the loading door(a click should be heard).
	“Start” button does not pressed.	Press the “Start” button.
Water does not enter the machine or detergent is not wash away.	Water tap not turned on.	Turn on water tap.
	Strainer in supply hose clogged.	Clean the strainer (refer to Page 31)
Detergent in chamber I is not wash away.	“Prewash” function is not selected.	Press “Prewash” button
Water cannot be seen in drum.	This is not a fault. The water lies below the visible part of the drum.	
Motor noise	Not a malfunction! It is normal for noises to be heard while the motor is running.	
Pump noise	Not a malfunction! It is normal for noises to be heard from the pump during the start or the final stage of draining the drum.	
Vibrations when washing and spinning	Transit bolts not removed.	Follow the directions in the installation instructions (page 37)
	The machine's feet were not secured.	Realign the machine using a spirit level, see the installation instructions.
Washing solution is not completely drained.	Loose debris is blocking the pump.	Clean the pump. (refer to Page 30)
	Fluff-producing laundry was washed at a high temperature. The water drainage pipe or drain hose is blocked.	Clean the water drainage pipe and/or drain hose.
Water is flowing out from underneath the machine.	The thread of the supply hose is not tight.	Tighten the thread.
	Leak in the drain hose.	Replace the drain hose.
Foam coming out of the detergent dispenser.	To much detergent.	Mix 1 tablespoon of fabric softener with 1/2 litre of water and pour into chamber I of the detergent dispenser. Reduce the amount of detergent next time.

Fault	Possible cause	Action
Repeated spinning at short intervals.	This is not a fault. The imbalance compensation system is attempting to balance the load through repeated spins.	
The program takes longer than usual.	This is not a fault. The imbalance compensation system is attempting to balance the load by distributing the laundry more evenly.	Wash large and small items together to reduce imbalances.
	The foam detection feature has activated an additional rinsing cycle to reduce the amount of foam.	Add a more appropriate amount of detergent next time.
The program takes longer than usual.	Drying programme not selected.	Select the desired drying programme.
	Drying time not set, or set drying time is too short.	Set the reasonable drying time.
	Tap not turned on.	Turn on the tap.
	Washer-dryer door not closed properly.	Check whether laundry is trapped in door. Close the washer-dryer door (click should be heard).
	Pump is blocked.	Clean the pump, see page 30
Unsatisfactory washing result.	The degree of dirt was higher than supposed.	Select a more suitable program.
	Not enough detergent.	Add detergent according to the manufacturer's specifications.
Detergent residual on the laundry.	Some phosphate-free detergents contain water-insoluble residues that may appear as light spots on the laundry.	Select "Rinsing" immediately, or brush off spots when laundry is dry.
Grey residues on the laundry.	Dirt accumulation from ointments, fats or oils.	Add the maximum amount of detergent and select the highest permissible temperature next time.
Programme duration changed during the programme sequence	Not a fault. See also explanations in the chapter programme duration from page 9.	

Installation, Connection and Transport

Safety information

⚠ Risk of injury

The washing machine is heavy. Take care when lifting it.

Caution

Frozen hoses can tear/burst. Do not install the washerdryer outdoors or in an area prone to frost.

Take care not to damage the washer-dryer. Do not hold onto protruding parts (e.g. Loading door) when lifting.

In addition to the safety information listed here, the local water and electricity supplier may have special requirements.

If in any doubt, have the appliance connected by an authorized technician.

Before leaving the factory every machine is thoroughly tested under operating conditions any moisture or residual water which you may find in the machine or grainage hose are left over from this testing.

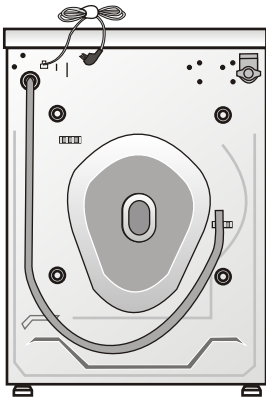

On the back of the machine:

- Water drain hose.
- Power cord.

The following tools are helpful:

- Wrench.
- Spirit level.

Dimensions

a=595mm
b=400mm
c=860mm
Approx. weight=68Kg

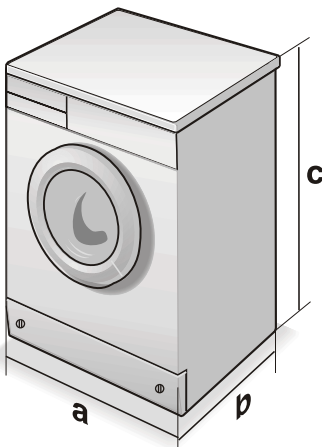

Installation location

To ensure the proper operation of the washer-dryer, please pay attention to the following when you install the machine.

- The floor should be solid and flat, never put the machine on the soft carpet or on the wood floor.
- Keep the environment dry and vented.
- Never put small appliance, such as microwave oven; and/or jar cooker, on the machine.
- Keep the machine away from the flaming equipment, such as candle, cooking stove, liquefied gas container etc.
- Never put the pressure containers on the machine.
- Never put the machine over the opening of uncovered drainage.
- In the case of suspended wooden floors, place the machine on a water-resistant wooden board (plinth) of at least 30mm thickness which is screwed to the floor. If possible, install the machine in a corner of the room. Secure the machine's feet with brackets (this applies particularly to tower arrangements).
- If the machine is installed on a plinth, the machine's feet must be secured with brackets to prevent it sliding when spinning.

Removing the transport bolts

The transport bolts must always be removed before using the appliance for the first time and must be retained for any subsequent transport (e.g. When moving)

Use the spanner provided only if a ring spanner is unavailable.

- Loosen all four transit bolts with the wrench until they are freely movable.
- If not all parts have been removed and have fallen into the bottom of the washer-dryer: open the door, pull the drum forwards slightly, reach in and remove the parts.

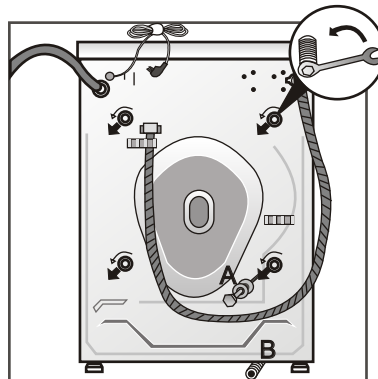

- Insert the covers.

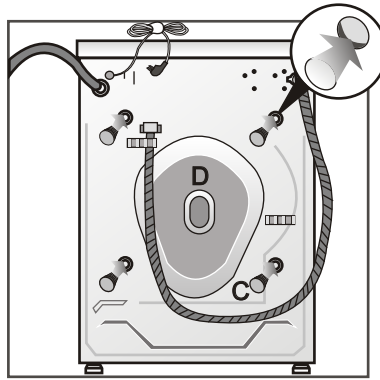

Hose and cable lengths

Left-hand connection

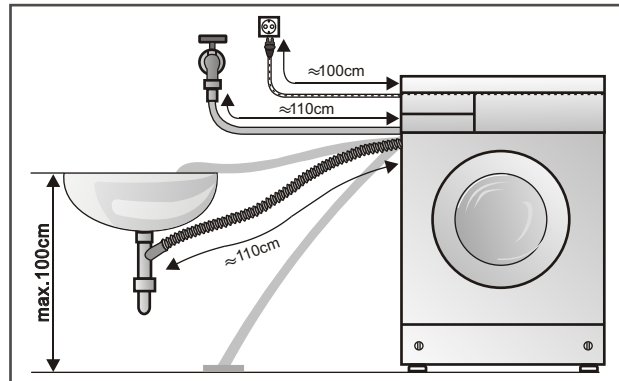

Right-hand connection

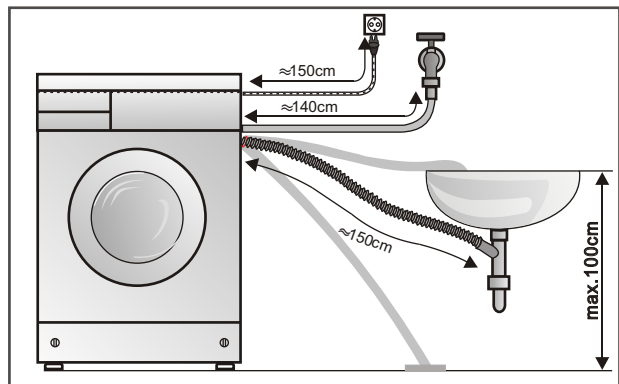

Caution:

In order to avoid siphon, do not put the outlet hose into a container with water.

Water connection

Water supply

For the water connection a standard cold-water line with a minimum water pressure of 0.1MPa is required (with tap full ON, at least 8 litres of water must flow out in one minute). If the water pressure exceeds 1MPa, a pressure reducing valve must be added.

- Never connect the machine to the mixer tap of a pressure-less hot-water heater.
- **Caution!** Connections are under full water pressure, check for leaks with tap turned fully ON.
- The filters at the free end of the inlet hose and at the back of machine should only be removed for cleaning purposes.
- To avoid water damage, the tap must be turned OFF after using the machine.
- The plastic nuts on the hose connections must only be tightened by hand.
- For tight connection between washer-dryer and water source, you can:

1. Call Customer Service before you install the machine, get the plastic connector freely. It may connect tightly the water inlet pipe and your water tap.

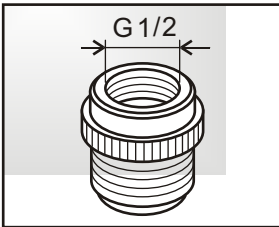

Plastic connector
CS code 424387



Water tap
CS code 184611

2. Or you may purchase the specific water tap from customer service. It is designed by factory. It may be better connected with machine than your water tap.

Note: The water tap is not free.

Caution:

- Do not disassemble the water inlet hose frequently, the untight connection will lead to leakage. We suggest that you use a water inlet hose specially for the washer-dryer.
- If you need lengthen the water inlet hose together with the machine, please contact local ASS center/station or leader to buy additional lengthening hose.
- Additional lengthening water inlet hose is not free.

Water Drainage

Caution

Do not bend or pull the water drainage hose.

Height between the placement area and drainage point:
maximum 100cm

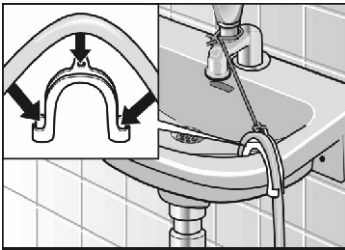
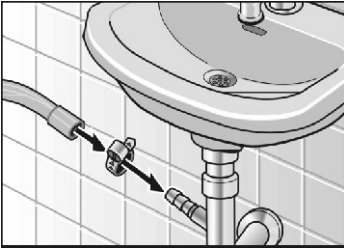

Drainage into a wash basin (The hose elbow is in the drum).

Caution

The plug must not block the drain of the wash basin.

- Secure the water drainage hose so that it does not slide out.
- When water is being drained, check that the water flow is fast enough.

Leveling procedure

All four appliance feet must be firmly on the ground.
The washing machine must not wobble

Level the washer-dryer with the assistance of the four adjustable feet and a spirit level.

- Loosen the counter-nut 1 using the wrench.
- Adjust the height by means of turning the appliance foot 2.
- Tighten the counter-nut 1.

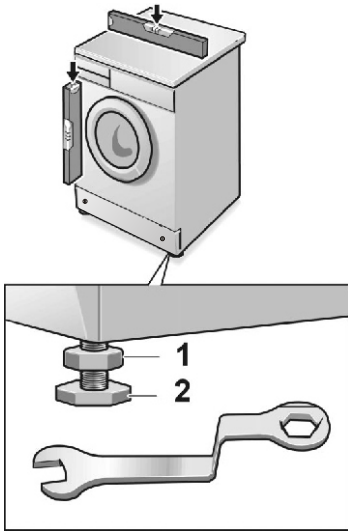

Transport e.g. when moving

Before transporting the washer-dryer:

- Turn off the water tap,
- Drain any residual washing solution (refer to Page 30),
- Release the water pressure in the supply hose (refer to Page 30),
- Disconnect the washer-dryer from the mains,
- Dismantle the supply and drainage hose,
Install the transport bolts.
- Having transported the appliance and ensured proper installation and connection, allow the Draining program to run through before starting the first wash program.

Preparing and inserting the transport bolts

- Remove the covers **C**.
- Remove the rear panel **D** (see page 38), prepare the transport bolt.
- Insert and tighten the bolts.
- Reinstall the rear cover **D**.

Electrical connection

- When heating, the maximum current of the washer-dryer is 10A, so please make sure that the power supply system (voltage, current and cable) is applicable to the load of the applied appliance.
- The machine must only be connected to an alternating current supply via a correctly installed earthed socket.
- The voltage indicated on the rating plate at the back of the machine must match the mains voltage at the installation location.
- Connected load and required fuse or line protecting cut-out are indicated on the rating plate.
- It must be ensured that the plug and socket match, that the conductor cross-section is sufficient and that the earthing system has been installed in compliance with regulations.
- Multiple plug connectors and extension cables must not be used.
- Do not connect the machine to electrical outlets while your hands are wet or damp.
- To remove the plug from the socket, grasp the plug firmly and pull it out. Do not pull at the cable.
- If the supply cord is damaged, it will be replaced by a special cord or an assembly available from the manufacturer or its service agent.-
- In the event that an earth-leakage circuit breaker is to be used, only use types marked with the following symbol: . Only this symbol can guarantee compliance with all current regulations.



Technical Data

Items \ Models	WVT52458
Rated voltage:	220V~
Rated frequency:	50Hz
Washing capacity:	5.2kg
Spinning capacity:	5.2kg
Drying capacity:	2.6kg
Water pressure:	0.1~1MPa
Water proof:	IPX4
Washing power:	200W
Spinning power:	450W
Heating power:	1800W
drying power:	1500W
Maximum power:	2000W
Maximum current:	10A

Package Sheet

Items \ Models	WVT52458
Washing machine	1
User manual	1
Fastening plug	4
Inlet hose	1
Bottom cover	1

Repair Indicator

- According to the Regulations of Responsibility concerning Repair, Exchange and Return of some commodities, warranty period of appliance purchased for home use purpose is one year for the complete unit and three years for the functional parts. Warranty period of appliances purchased for business, commercial or company use is 3 months for complete unit and functional parts unless otherwise specified in the contract.
- Warranty period for appliance sold at reduced prices is same, but no warranty claim for price reduced position.
- Within warranty period, the consumer should show the valid purchase invoice of the appliance and other relevant guarantee documents defined by the manufacturer when asking for free of charge repair. Consumer should keep the warranty card and the purchase invoice properly and show them together when asking for free of charge repair. The warranty period starts from the invoice date. If the customer loses the invoice, it starts from the manufacturing date.
- The following cases are not covered by the free of charge repair and should be paid by the customer:
 - Damage caused by improper transportation, installation, operation, maintenance and storage by customer.
 - Damage caused by power supply on customer site less than 187V or more than 240V.
 - Damage caused by unauthorized repair.
 - Without valid purchase invoice or without relevant guarantee document.
 - The guarantee document is amended by customer or does not accord with the appliance.
 - Damage caused by force majeure.
 - Out of warranty.

If the appliances are used under condition of improper power supply, water supply, temperature or humidity, the damage and loss are not covered by the free of charge repair and should be paid by the customer.

Because the factors mentioned above is beyond the control of manufacturer.

In order to provide prompt service, our service staff needs specific information about the appliance.

Please inform the following us to in details:

- Exact address and telephone number.
- Failure description.
- Date of purchase.
- Product number (E-Nr.) and Production date(FD).
This Nr. can be found on the door label.

Door label.

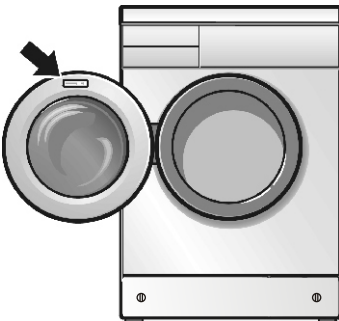

Service Assurance

- 24 hours hotline service
- Door to door service within 24 hours within city boundary
- Free of charge installation except additional material cost
- Free of charge once transfer within one year.
- Free of charge consulting
- Be responsible for service a lifetime long

Warranty card



Customer Name		Contact telephone	
Address			
Purchase date			
Product code		Invoice no.	
Maintenance station		Station telephone	

Record sheet 5



Customer Name		Address	
Purchase date		Invoice no.	
Product code		Production date	
Maintenance date		Serial number	

Record sheet 4



Customer Name		Address	
Purchase date		Invoice no.	
Product code		Production date	
Maintenance date		Serial number	

Record sheet 3



Customer Name		Address	
Purchase date		Invoice no.	
Product code		Production date	
Maintenance date		Serial number	

Record sheet 2



Customer Name		Address	
Purchase date		Invoice no.	
Product code		Production date	
Maintenance date		Serial number	

Record sheet 1



Customer Name		Address	
Purchase date		Invoice no.	
Product code		Production date	
Maintenance date		Serial number	

5120 004791(PD 84 09 25)

800免费咨询电话：8008280088

全国统一客户服务专线：4008855888

未开通800地区拨打：0550-3062800 传真：0550-3072600

客户服务电子信箱E-mail: Careline.China@BSHG.com

BOSCH