

Washer  
LOGIXX 9 New dimensions



en Operating, Care and  
Installation Instructions



Household Appliances

**BOSCH**

# Table of Contents

<b>Your Bosch washing machine</b> .....	<b>3</b>
<b>General safety instructions</b> .....	<b>3</b>
<b>Information concerning waste disposal</b> .....	<b>3</b>
<b>Installation Instructions</b> .....	<b>4</b>
Introduction .....	4
Information concerning waste disposal .....	4
Protection of the environment / Hints and tips .....	4
Standard accessories .....	5
Dimensions .....	5
Installation surface .....	5
Remove the transportation safety devices .....	6
Aligning the washing machine .....	6
Connecting the power .....	6
Hose and-cable lengths .....	7
Water connection .....	8
<b>Operating manual</b> .....	<b>9</b>
Your new washing machine .....	9
Control panel .....	10
<b>Before using your washing machine for the first time</b> .....	<b>11</b>
<b>First wash cycle</b> .....	<b>11</b>
Selecting the language .....	11
Setting the time .....	11
First wash cycle (without washing) .....	11
Preparing the washing .....	12
Sorting the washing .....	12
Degrees of dirt .....	12
Loading the laundry .....	13
<b>Laundry Detergents and Additives</b> .....	<b>13</b>
Dispensing the correct amount of detergent .....	13
Pour in detergent and/or cleaning product. ....	13
<b>Programmes and functions</b> .....	<b>14</b>
Basic programmes .....	14
Special applications .....	14
Display .....	15
Additional options .....	15
Indicator light in the Start/Pause button .....	15
Special applications .....	16
<b>Washing with standard settings</b> .....	<b>17</b>
<b>Washing with individual settings</b> .....	<b>18</b>
Programme Overview .....	18
Spin speed .....	19
Programme finished at? .....	19
Wash .....	20
Signal .....	21
Childproof lock .....	22
Setting the time .....	23
<b>During washing</b> .....	<b>24</b>
Select a programme again .....	24
Topping up the washing/Interrupting the programme .....	24
Cancelling active programme .....	24
<b>After washing</b> .....	<b>25</b>
<b>Maintenance and care information</b> .....	<b>26</b>
Cleaning and Care .....	26
Descaling the washing machine .....	27
<b>Troubleshooting Minor Faults</b> .....	<b>28</b>
Fault displays .....	30
<b>Consumption values</b> .....	<b>31</b>
<b>Customer service</b> .....	<b>32</b>
<b>Installing, connecting and transporting the appliance</b> .....	<b>33</b>
Safety instructions .....	33
<b>Quick-reference instructions</b> .....	<b>34</b>

---

# Your Bosch washing machine

The new washing machine which you have just purchased is a modern, high quality domestic appliance.

Your washing machine is distinguished by its economical consumption of energy, water and detergent.

Each washing machine which leaves our factory is checked carefully to ensure that it functions properly and is in perfect condition.

If you have any questions – especially with respect to installing and connecting your washing machine – please do not hesitate to contact our customer service department.

Further information and a selection of our products can be found on our Internet page:

<http://www.bosch-hausgeraete.de>

Please read these operating and installation instructions and all other information enclosed with the washing machine and act accordingly.

Retain all documentation for subsequent use or for the next owner of the appliance.

---

# General safety instructions

Your washing machine is intended for

- use in the household only,
- washing machine-washable textiles in water,
- operation with cold drinking water and commercially available detergents and cleaning products which are suitable for use in washing machines.

Do not leave children unsupervised near the washing machine.

Keep pets away from the washing machine.

Do not insert/pull out the mains plug with wet hands.

Do not pull out the mains plug by tugging the cable.

Caution when draining hot water.

Do not touch the loading door when washing at high temperatures.

Do not climb onto the washing machine.

Do not lean on the open washing machine door.

---

# Information concerning waste disposal

## Disposal of packaging

Your new appliance was delivered to you in protective packaging. All utilised materials are ecologically harmless and recyclable. Please help by disposing of packaging in an environmentally friendly manner.

Please ask your dealer or inquire at your local authority about current means of disposal.

### **⚠ Risk of choking!**

Do not let children play with packaging and associated parts. Risk of choking on plastic film and collapsible cardboard boxes.

## Disposing of your old appliance

Old appliances are not worthless rubbish! Valuable raw materials can be reclaimed by recycling old appliances.

### **⚠ Danger of death!**

Unplug mains plug on redundant appliances. Cut off mains cable and discard with mains plug.

Destroy the lock on the door. This will prevent children from locking themselves in the appliance and suffocating.

---

# Installation Instructions

## Introduction

Observe and follow the warnings and instructions below:

These installation instructions are intended for qualified fitters.

In addition to these installation instructions, observe the following when installing the appliance:

If the washing machine is in a room exposed to low temperatures or if the washing machine is in a room which is not used over winter, the residual water **must be** removed from the water pump and the hoses.

Do not damage the washing machine.

Do not lift the washing machine by its projecting parts (e. g. door). In addition to the safety information listed here, the local water and electricity supplier may have special requirements.

If in doubt, have the appliance connected by a specialist.

## Information concerning waste disposal

### Disposing of the packaging

Your new appliance was delivered to you in protective packaging. All utilised materials are ecologically harmless and recyclable.

Please contribute to a better environment by disposing of packaging materials in an environmentally conscious manner.

Please ask your dealer or inquire at your local authority about current means of disposal.

## Protection of the environment / Hints and tips

Your washing machine uses water, energy and detergent efficiently, thereby protecting the environment and reducing your household costs.

Using your washing machine in an efficient and environmentally friendly manner:

- Avoid using too much detergent.
- Use an efficient detergent suitable for front loader washing machines.
- Add detergent according to the degree of soiling, amount of laundry and water hardness, and observe the detergent manufacturer's instructions.

## Standard accessories

Several accessories are enclosed with your washing machine. Check that all the accessories for your model are enclosed. If specific parts are missing, contact your dealer immediately.

Inside the drum:

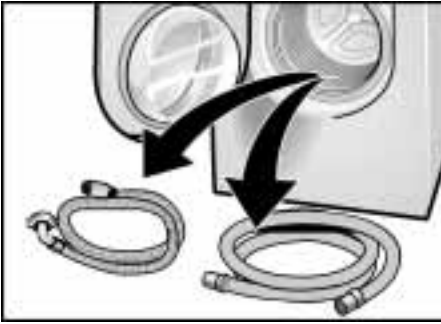

- Supply hose (blue mark)
- Water drainage hose.
- The bag contains:

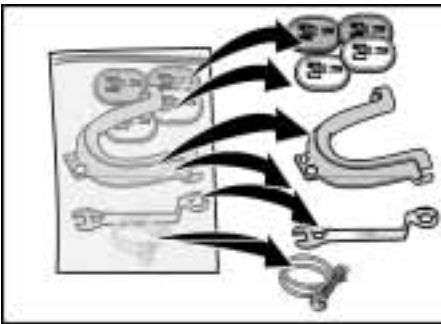

- Covers for placing over the openings when the transportation bolts have been removed.
- Lock for drainage hose.
- Wrench for adjustment.
- Elbow for attaching the drain hose, e.g. into a wash basin

Depending on the connection situation, the following part is also required:

- 1 hose clip  $\varnothing$  24–40 mm (DIY store) is also required for connection to a siphon.

Moisture in the drum is due to the final inspection which every washing machine undergoes before it leaves the factory.

On the rear of the appliance:

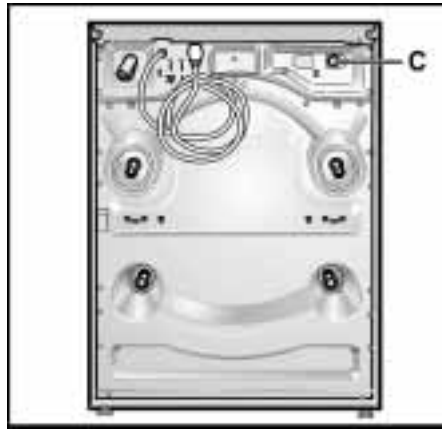

- Power cord with plug.

C....Connection for supply hose

### Useful tools

The following tools are helpful:

- Screwdriver.
- Ring wrench (SW 13) for removing the transport bolts.
- Spirit level for adjustment.

## Dimensions



a = 686 mm

b = 780 mm

c = 940 mm

d = 407 mm

Opening angle 180°

Weight approx. 100 kg

## Installation surface

Stability is important to prevent the washing machine from “wandering” during the spin cycle.

The installation surface must be solid and level. Soft floor surfaces, such as carpets or surfaces with foam backing, are not suitable.

If the washing machine is to be installed on a wooden floor:

- If possible, install the washing machine in a corner.
- Screw a water resistant wooden board (min. 30 mm thick) to the floor.
- Secure the front feet of the washing machine with holding brackets. Holding brackets (set) can be obtained from a specialist store or the Customer Service (WMZ 2200).
- The appliance cannot be top-mounted.
- The appliance cannot be built under.

### Installation of base

If the washing machine is installed on a base (order no. WZ 1295), follow the instructions in the operating manual!

- i** Install the holder BEFORE removing the transportation protection devices.

### Installation in a recess

If the washing machine is to be installed in a recess, observe the minimum distances indicated in the following table:

	Distance
Sides	6 mm
Upper edge	305 mm
Rear	64 mm
Front	6 mm

## Remove the transportation safety devices

### ⚠ CAUTION!

The transport bolts must always be removed before using the appliance for the first time and must be retained for any subsequent transport (e. g. when moving).

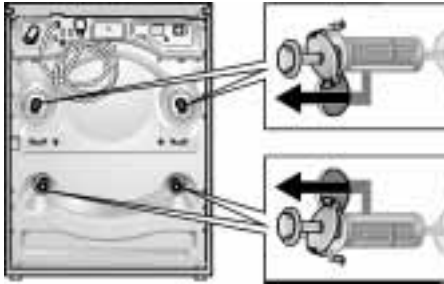

- Release all screws and using the SW 13 wrench until they can be moved freely.
- Completely remove the transportation safety device (screw and spring, washer and bush).

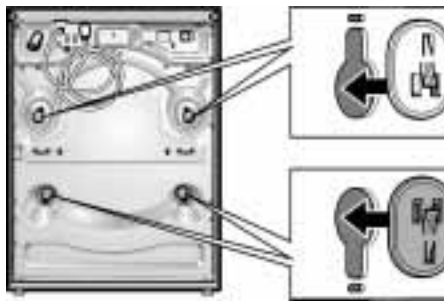

- Insert the covers.

## Storing the transportation protection devices

Always keep the transport bolts for subsequent transportation of the appliance (e. g. when moving house).

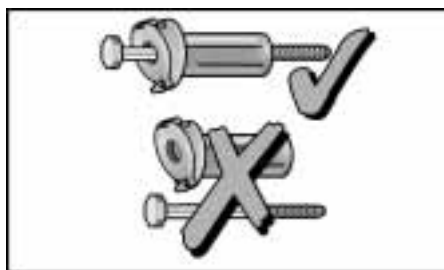

- Store transport bolts and (screw washer and bushing onto bolt).

## Aligning the washing machine

All four appliance feet must be firmly on the ground. The washing machine must not wobble.

Align the washing machine with the aid of the four height-adjustable feet and a spirit level:

- Loosen the lock nut **1** using the wrench.
- Adjust the height by rotating the foot **2**.
- Tighten the lock nut **1** against the housing.

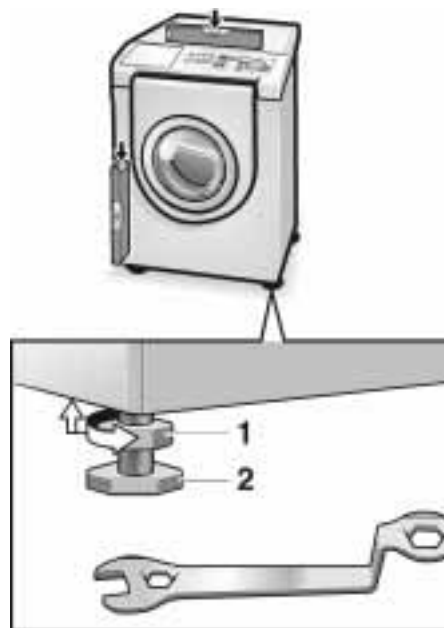

## Connecting the power

### Attention

Connect the washing machine only to an alternating current via a correctly installed earthed socket.

The mains voltage must correspond to the voltage specification on the washing machine (nameplate).

Connected load and the required fuse are indicated on the rating plate.

Ensure that:

- The mains plug and socket are compatible,
- The cable cross-section is adequate,
- The earthing system has been installed correctly.

The mains cable may be changed (if required) by an electrician only.

A replacement mains cable can be obtained from customer service.

Do not use multiple plugs / connectors or extension cables.

In the event that an earth-leakage circuit breaker is to be used, only use types marked with the following symbol: . Only this symbol can guarantee compliance with all current regulations.

Do not pull out the mains plug by tugging the cable.

Do not insert/pull out the mains plug with wet hands.



# Hose and-cable lengths

Connection on left side

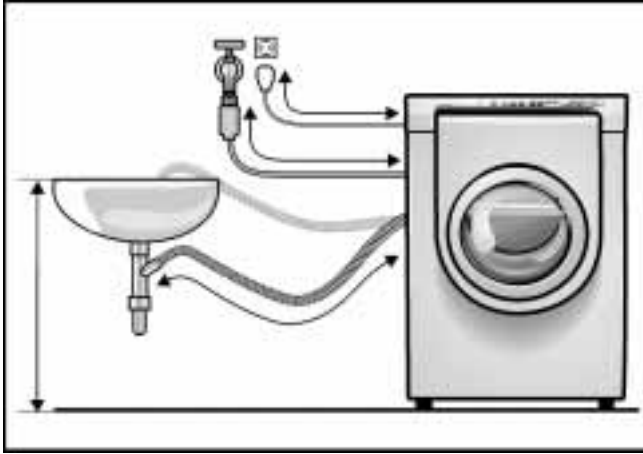

- a = 140 cm (approx.)
- b = 130 cm (approx.)
- c = 85 cm (approx.)
- d = 100 cm (max.)

- e = 175 cm (approx.)
- f = 88 cm (approx.)
- g = 140 cm (approx.)

Connection on right side

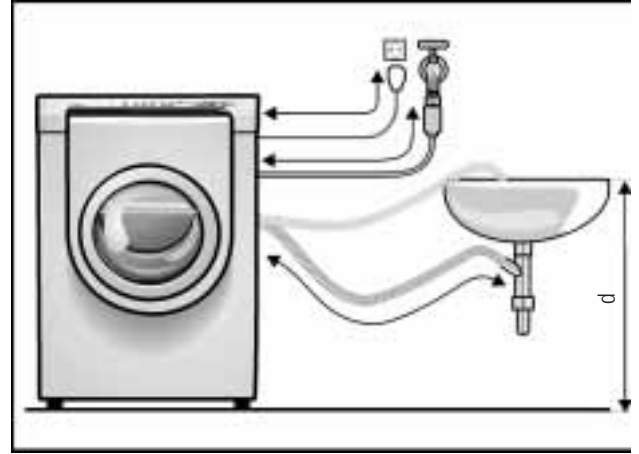

## Other hoses

Available from specialist dealers:

- Extended supply hose (approx. 2.44 m).

# Water connection

## Water inlet hose

### ⚠ CAUTION!

Operate the washing machine with cold drinking water only. Do not connect to the mixer tap of an unpressurised hotwater apparatus.

Only use the new delivered supply and drainage hoses. Never connect old used hoses.

If in doubt, have the appliance connected by a specialist.

The water inlet hose must not be

- kinked or crushed,
- modified or severed (strength is no longer guaranteed).

Plastic threads must only be tightened by hand. Do not remove the strainers from the water supply hoses.

## Connecting the supply hose:

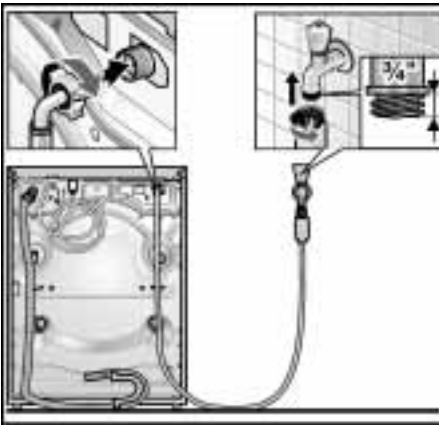

- ❑ After connecting the supply hose, turn on the tap and check that water comes out.

Observe the mains water pressure.

- The water pressure should be between 1 and 10 bars (when the tap is turned on, at least 8 litres of water is discharged per minute).
- If the water pressure is higher, install a pressure reducing valve.

## Water drainage hose

Height difference between the placement area and drainage point: maximum 100 cm.

### Connect the water drainage hose:

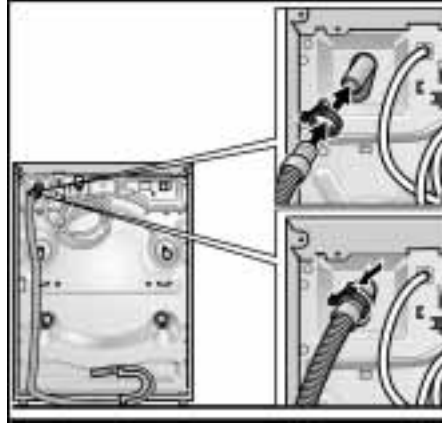

- ❑ Attach the drainage hose to the drainage spigot on the machine.
- ❑ Secure the connection point with the hose band clip. Use a screwdriver.

## Drainage into a standpipe

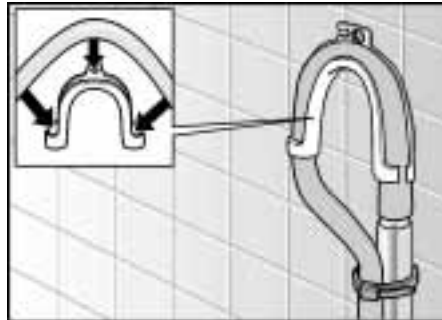

- ❑ Use a bend. Attach the bend to the end of the drainage hose and insert the end of the hose into the waste pipe.
- ❑ Attach the hose in the correct position with tape or a fixing plate

## Drainage into wall-mounted connection

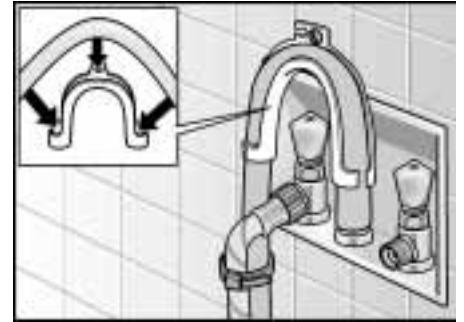

- ❑ Use a bend. Attach the bend to the end of the drainage hose and insert the end of the hose into the waste pipe.
- ❑ Attach the hose in the correct position with tape or a fixing plate.

## Drainage into a siphon:

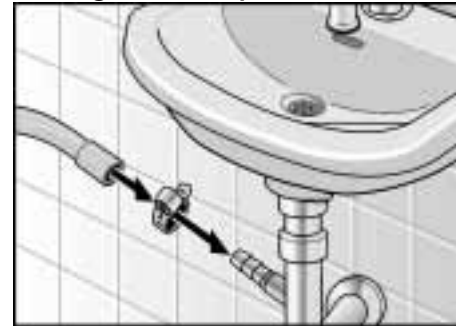

- ❑ Secure connection point with Ø 24–40 mm hose clip (specialist outlet).

## Drainage into a wash basin



- ❑ Attach drainage hose securely to the wash basin.
- ❑ When the water is being pumped out of the washing machine, check that the water drains away quickly enough.



# Operating manual

## Your new washing machine

Pour in detergent and/or cleaning product



Open the door (red mark) ...



... Close the washing machine door



# Control panel

## Buttons for additional options

(in addition to the programme if required)

**Prewash:** Prewash can be switched on in addition to a selected programme.

**Extra rinsing:** Additional rinsing cycle.

**Reduced Ironing:** Gentler reduced spin cycle with subsequent fluffing.

### Additional option selected:

Indicator light is **flashing red**

### Switch off additional option:

Press button again. Indicator light goes out.

## Display

Indicates the settings which have been selected or which are to be changed (e.g. spin speed, end time, intensity, signal, childproof lock, summer time, time) as well as the programme sequence.

## Programme selector

For switching the machine on and off and for selecting the programme. Can be rotated in either direction.

The programme selector does not rotate while the programme is running – the programme sequence is electronically controlled.

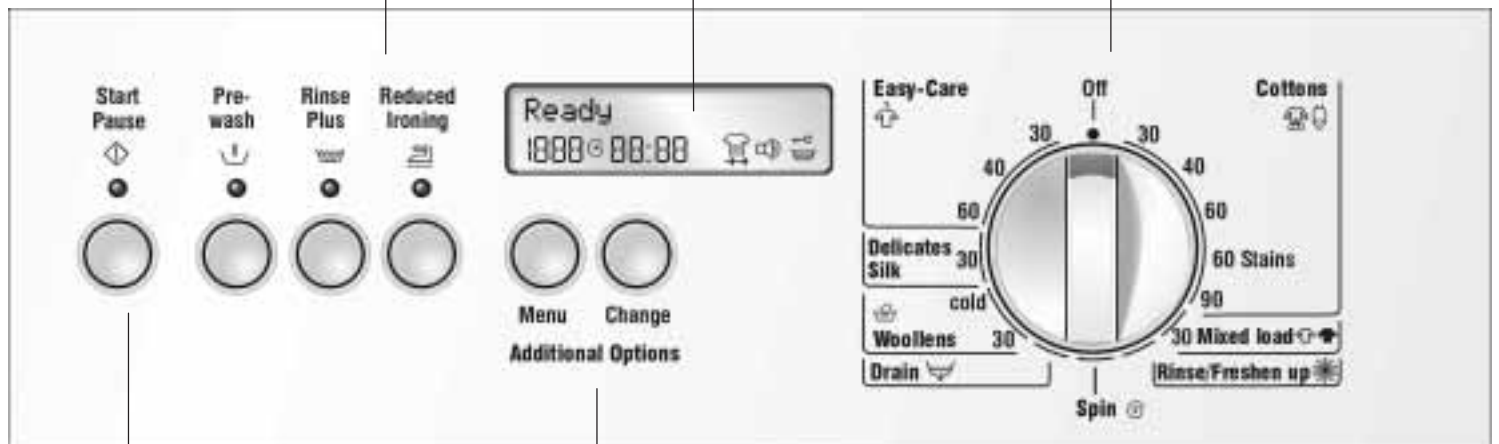

## Start/Pause button

For starting or interrupting the washing process (programme must be selected).

## Indicator light

The indicator light is lit red: Settings can be changed or the wash cycle can be started. The door is locked for safety reasons, childproof lock is active or the programme is in "Pause" mode.

Indicator light is lit red: programme is running and "Pause" mode can be activated.

Indicator light goes out: programme has ended or no programme was selected.

## Menu

For selecting settings which are to be changed.

## Change

For changing all the settings in the display field.

# Before using your washing machine for the first time

The washing machine must have been installed and connected properly refer to Page 4.

Before using your washing machine for the first time:

- The mains voltage and the voltage specifications on the washing machine (rating plate) must correspond.
- The washing machine must have been installed and connected properly.
- Tap must be turned on.

# First wash cycle

## Selecting the language

- i** The programme selector must not be set to **Off**.
- i** The language must be selected before a programme is started.
- Simultaneously press the **Menu** and **Change** buttons and hold down (5 seconds) until the current setting is displayed.



- Press the **Change** button until the desired signal volume is displayed.
- Confirm the language selection by pressing the **Menu** button.
- i** If no button is pressed, the new language setting is automatically accepted after 5 seconds.
- i** The selected setting is retained after the wash cycle.

## Setting the time

- i** Before the individual settings can be selected (in particular "Programme finished at"), the time must be set, see Page 23.

## First wash cycle (without washing)

Your appliance was tested before leaving the factory. To remove any water left over from testing procedures, the first washing cycle should be carried out without laundry in the machine.

- Do not load any washing.
- Turn the tap on.
- Open the cover on the detergent drawer.
- Pour approx. 1 litre of water into dispenser **I**; see Page 13.
- Half fill the measuring beaker with detergent and pour into chamber **I**.

- i** Do not use woollens or mild detergent (foam formation).
- Close the cover on the detergent drawer.
- Close the door.
- Set the programme selector to Cottons 90°. The **Start/Pause** indicator light flashes (red).
- Press the **Start/Pause** button. The programme starts. The indicator light is on (red).
- i** The individual programme steps are indicated in the display field.

When "Remove washing" is displayed:

- Open the door.
- Turn the programme selector to **Off**.

## Preparing the washing

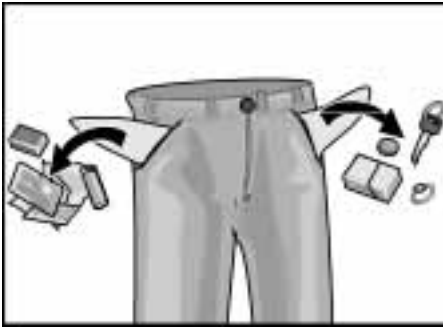

- ❑ Empty pockets of laundry items.
- ❑ Brush sand out of pockets and cuffs/turn-ups.
- ❑ Close zips, fasten pillow cases/cushion covers.
- ❑ Remove curtain runners or tie up in a net/bag.
- ❑ Remove foreign objects/fluff from inside and clean the interior.
- ❑ Remove non-washable parts.
- ❑ Trousers, knitwear and knitted textiles, e.g. jersey garments, T-shirts or sweatshirts should be turned inside out.
- ❑ Pretreat stains.
- ❑ Underwired bras (wire may become loose during washing and cause damage), small items (socks and handkerchiefs), tights and belts should be washed in a bag to prevent them from "getting lost".

## Sorting the washing

According to colour and degree of dirt

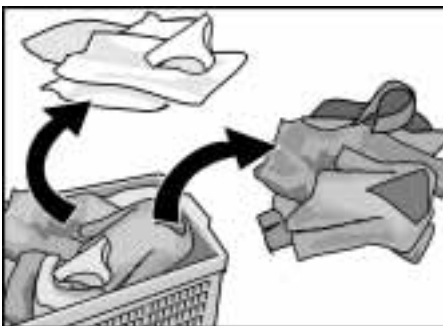

White items may become grey. Wash white and coloured items separately.

## Degrees of dirt

### lightly soiled

No visible soiling or stains. Washing has probably absorbed body odour.

- Light weight summer clothing
- T-shirts, shirts, blouses worn for up to one day.
- Bed linen, guest towels used for one day.

### normally soiled

Visible soiling and/or a few light stains.

- T-shirts, shirts, blouses soaked in sweat or worn several times.
- Tea towels, hand towels, bed linen used for up to one week.
- Net curtains (without nicotine staining) that have not been washed for up to ½ year.

### very soiled

Visible soiling and/or stains.

- Kitchen towels used for up to one week.
- Fabric serviettes.
- Baby bibs.
- Children's outer clothing or football jerseys and shorts soiled with grass and/or earth.
- Working clothes such as overalls or baker's and butcher's coats.

### Typical stains

- Skin grease, cooking oil/fat, sauces, mineral oil, wax (containing fat/oil).
- Tea, coffee, red wine, fruit, vegetables.
- Blood, egg, milk, starch (containing protein, carbohydrate).

- Soot, earth, sand (pigments), tennis clothing soiled with red clay.

## Removing stains

Remove/pretreat stains as soon as possible after they have occurred.

First dab with a soapy solution. Do not rub.

Then select the appropriate programme and wash the item.

Several washing cycles may sometimes be required in order to remove stubborn / dried in stains.

## Sorting washing according to the instructions on the care labels

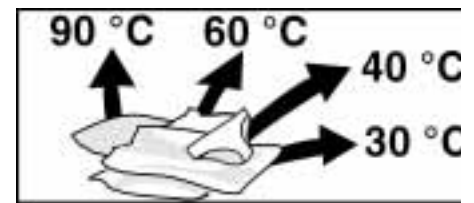

Only wash laundry items which bear the following care labels.



Cottons 95 °C, 90 °C



Cottons 60 °C, 40 °C, 30 °C



Easy-Care 60 °C, 40 °C, 30 °C



Delicates 40 °C, 30 °C



Hand-washable and machine-washable silk and wool, cold, 40 °C, 30 °C

Do not wash laundry items which bear the following care label in the washing machine:



### **⚠ Risk of explosion !**

Laundry items which have been pretreated with detergents containing solvents, e. g. stain remover or cleaner's solvent, must be rinsed out thoroughly by hand before they are placed in the washing machine, otherwise there is a risk of explosion. Before loading the laundry, rinse thoroughly by hand.

### **Attention**

Foreign objects in the drum may damage the laundry. Before inserting the laundry, ensure that there are no foreign objects in the drum.

## **Loading the laundry**



- Open the door.



- Unfold the sorted items of clothing and place them loosely into the drum. Mix large and small items. Washing items of different size distribute themselves better during the spin cycle.
- i** Do not exceed the maximum load. Overloading will cause poor wash results and encourage creasing.

The recommended wash load is displayed depending on the selected programme and additional functions, see from Page 31.

### **Full load**

Cotton and linen

### **1/2 Load**

Cotton, synthetic fibres or knitted textiles

### **1/3 Load**

Woolens, Delicates, Silk

- Close the door.  
Take care not to trap any items of clothing between the loading door and rubber seal.  
Door must close easily and not forced close.

## **Laundry Detergents and Additives**

### **⚠ Risk of poisoning!**

Keep detergents and cleaning products out of the reach of children.

## **Dispensing the correct amount of detergent**

Dose detergent according to

- the water hardness. This information can be obtained from your local water authority.
  - the amount of laundry.
  - the degree of soiling. See from Page 15 for degrees of soiling.
  - the specifications of the detergent manufacturer.
- Dispensing the correct amount of detergent relieves the strain on the environment and ensures optimum washing results.

### **Too little detergent:**

the laundry is not washed clean and eventually becomes grey and hard. Greyish-brown dots (grease spots) may stain the laundry. The heating elements are calcifying.

### **Too much detergent:**

Environmentally incompatible, excessive foam reduces wash agitation causing poor washing and rinsing results.

## **Pour in detergent and/or cleaning product.**

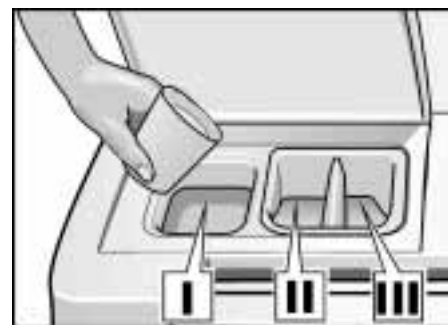

- Open the cover on the detergent drawer.
- Pour in detergent and/or cleaning product.

Dispenser I: Main wash  
Dispenser for detergent, stain remover.

Dispenser II: ☼  
Liquid detergent, cleaning product, e.g. fabric softener or fabric conditioner. Pour in to max. lower edge of the mark.

Dispenser III: Prewash  
Prewash dispenser for detergent, stain remover and starch

- i** Dilute concentrated and viscous fabric softener or fabric conditioner with a little water before pouring it into dispenser II (prevents blockage of the overflow).
- Close the cover on the detergent drawer.



# Programmes and functions

The programme duration is dependent on water pressure, water hardness, water inlet temperature, room temperature, type and amount of washing, fluctuations in the mains voltage and selected additional functions.

The maximum spin speeds are dependent on the selected programme. Setting the spin speed see Page 24.

## Basic programmes

### Cottons 90°

For boil-proof textiles which are heavily soiled or stained.

For hard-wearing textiles, e.g. made of cotton or linen, such as towels, bed linen or white sports socks.

### Cottons 60°

Recommended for colourfast, normally and/or heavily soiled washing. For hard-wearing textiles, e.g. made of cotton or linen, such as work clothes or underwear.

### Cottons 60° Stains

Deep-cleaning, stain removing programme for hard-wearing textiles made of cotton.

### Cottons 40°

Recommended for colour sensitive, lightly and/or normally soiled washing. For textiles, e.g. made of cotton or linen, such as jeans, T-shirts and sweatshirts.

### Cottons 30°

Recommended for colour sensitive, lightly soiled washing.

For hard-wearing textiles, e.g. made of cotton or linen (if colours can fade or disappear).

### Easy-Care 60°

For easy-care, normally soiled, colourfast textiles, e.g. made of cotton, linen, synthetic fibres or blended fabrics. These types of washing require a special programme sequence and reduced spin speeds in order to reduce crease formation.

### Easy-Care 40°

For easy-care, lightly and/or normally soiled colour sensitive textiles, e.g. made of cotton, linen, synthetic fibres or blended fabrics. These types of washing (e.g. blouses, shirts and overalls) require a special programme sequence and reduced spin speeds in order to reduce crease formation.

### Easy-Care 30°

For easy-care, lightly and/or normally soiled colour sensitive textiles, e.g. made of cotton, linen, synthetic fibres or blended fabrics. These types of washing require a special programme sequence and reduced spin speeds in order to reduce crease formation.

## Special applications

### Delicates/Silk

For sensitive, washable textiles, e.g. made of silk, satin, synthetic fibres or blended fabrics (e.g. curtains, dresses, skirts and blouses).

Large items, e.g. leisure suit, can be washed in this wash programme because the moves gently and an additional rinse programme is added automatically.

No spin between the rinse cycles.

### Woollens cold

Hand wash is recommended for very sensitive items which are usually washed by hand.

This wash programme was developed for particularly gentle treatment of the washing.

Silk or other textiles with the “hand wash” instruction or  on the care labels can be washed safely with this programme.

### Woollens 30°

For hand and machine-washable textiles made of wool.

### Mixed load 30°

For clothing made of microfibres.

### Spin

Spin cycle for spinning hand-washed items.

Washing water or rinsing water is drained before the spin cycle.

### Rinse/Freshen up

Programme for rinsing unsoiled textiles, e.g. swimwear, and for removing detergent residue from textiles. Ends with a short rinse cycle. Water is drained.

### Drain

Rinsing water is drained without a spin cycle.

### Maximum spin speeds of the programmes

Revolutions per minute	Type of laundry / Programme options
1200	Cottons
800	Easy-Care
600	Silk/Hand wash
800	Woollens
600	Mixed load
1200	Spin
400	Rinse/Freshen up

In the **Cottons** programme the fabrics will be spun at the maximum possible spin speed.

### In the **Easy-Care, Delicates/Silk, Woollens and Mixed load**

programmes the washing machine spins at a low speed – for gentle treatment of delicate laundry. If required, change the spin speed. Minimum spin speed is 400 revolutions per minute.



## Display

The running programme and programme status are displayed on the left side of the first line. The current time is displayed on the right side when “Ready” is displayed on the left side.

Spin speeds and the expected end time of the programme as well as symbols for spin speed, wash mode, soaking, signal and childproof lock are displayed on the second line.

### Spin speed or without final spin

Maximum spin speeds of the programme are displayed. “----” is displayed during the **Drain** programme.

The speeds can be changed.

**Without final spin** can also be selected.

### Without final spin (“----”)

The laundry is left in the final rinsing water. Recommended for sensitive washing.

Use this additional function to prevent creasing if the washing cannot be taken out of the drum as soon as the programme ends.

### Programme finished at

The time is displayed when the programme will end.

#### Symbol for “Normal Wash”

This symbol is on if “Normal Wash” was selected.

#### Symbol for “Quick Wash”

This symbol is on if “Quick Wash” was selected.

#### Symbol for “Intensive Wash”

This symbol is on if “Intensive Wash” was selected.

#### Symbol for signal

This symbol is on if the signal volume was not set to **Off**.

#### Symbol for childproof lock

This symbol is on if **Child lock: ON** was selected in the menu.

## Additional options

### Prewash



If the Prewash button was pressed, a prewash cycle is run in addition to the selected programme.

Programme for pretreatment of heavily soiled, stained textiles.

Soaking programme lasts 2 hours and ends with a short spin cycle. Water is drained. Washing time is extended accordingly.

### Rinse Plus



If the Rinse Plus button was pressed, a rinse cycle is run in addition to the selected programme. Washing time is extended accordingly.

### Reduced Ironing



If the Easy-iron button was pressed, a gentler, reduced spin cycle is run followed by fluffing up of clothes. After the spin cycle, the laundry is loose in the drum – creasing is reduced. Washing time is extended accordingly.

**i** Remove the laundry as soon as the spin cycle is complete.

## Indicator light in the Start/Pause button

The indicator light conveys the following information:

- The **Start/Pause** indicator light flashes (red): Programme can be started. Top up possible.
- The **Start/Pause** control light comes on (red): Programme is running. The door is locked for reasons of safety and cannot be opened.

The door can be opened because the **Start/Pause** button was pressed.

#### **i** Exception:

When the childproof lock is activated, the **Start/Pause** indicator light is off. At the end of the programme the door remains locked.

## Special applications

### Load adjust

Load adjust adjusts the water and power consumption to each programme – according to the amount of laundry and type of textiles.

The auto load function is a component of your washing machine and runs automatically.

This keeps the energy and water consumption as low as possible.

The flow sensor measures the water flow rate like an internal water gauge and meters the exact volume of water required by the amount of washing.

The stepless water level sensor ensures the correct water level required to wash your laundry in each programme.

### Unbalanced load detection system

The automatic unbalanced load detection system spins the laundry several times to ensure even distribution.

If the washing is very unevenly distributed, it is not spun for reasons of safety or the end speed is reduced.

In the Woollens programmes the spin cycle is attempted only twice in order to prevent felting.

### Time

When a programme has been selected, the expected programme duration is displayed.

Time deviations are caused by:

- load amount
- Multiple spinning if the laundry is distributed poorly in the drum.
- Additional rinse cycle if excessive foam is in the laundry.
- too low water pressure
- Selection of an additional option, e.g. Rinse Plus, after the programme has started,

As a result of this and other properties, the wash time changes accordingly.

**i** If no additional options were selected and if no other changes occur, the wash cycle will end at the indicated time.

# Washing with standard settings

The specified standard settings are optimally adjusted to the selected programme.

If you do not want to change these standard settings:



- Turn the tap on.



- Turn the programme selector to the desired programme.



- Load the laundry and close the loading door.

The **Start/Pause** indicator light flashes (red).



- If required, press the button(s) for additional option(s). The indicator light of the selected button is on (red).

- i** If an illogical combination was inadvertently selected – the indicator light of the selected button goes out and a signal is emitted.

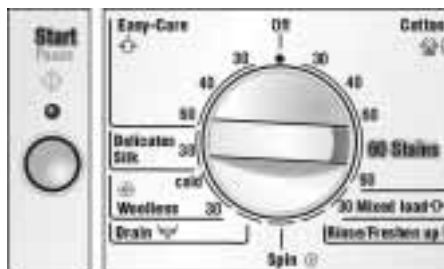

- Press the **Start/Pause** button. The indicator light is on (red). The programme starts.

- i** The programme progress is indicated in the display field.

Washing with individual settings is described subsequently.

# Washing with individual settings

You can adjust the settings to your requirements.

First find a quick overview of the adjustable settings.

The steps for changing the settings are described in detail overleaf.

## Programme Overview

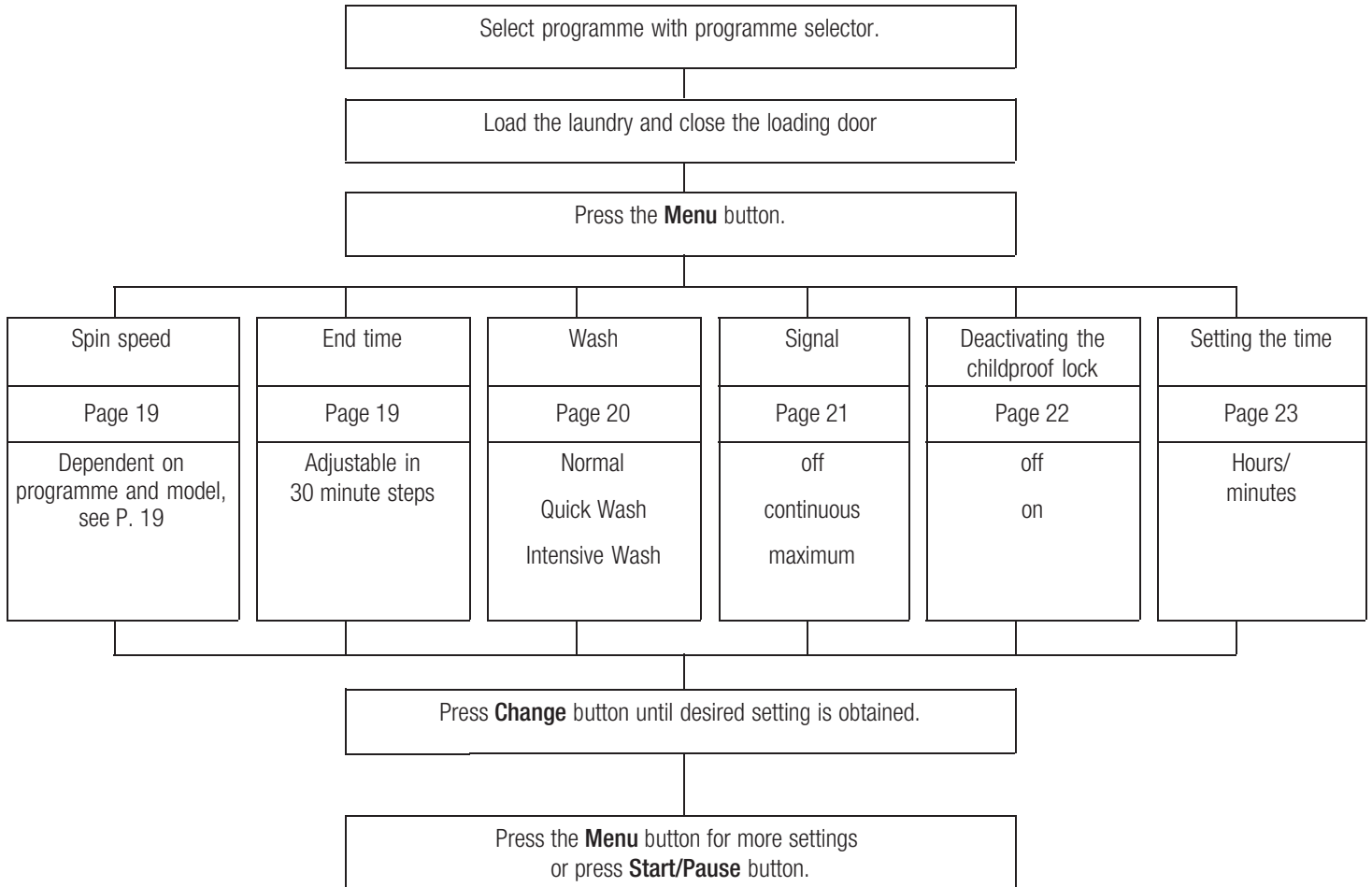

## Spin speed

The speeds can be changed.

The maximum displayed spin speed depends on the selected programme. See also information on Page 18.

- ❑ Turn the programme selector to the desired programme.
- ❑ Load the laundry and close the loading door.  
The **Start/Pause** indicator light flashes (red).

### Example:



- ❑ Press the **Menu** button until "Spin speed:" is displayed. Current spin speed flashes. The **Start/Pause** indicator light flashes (red).

- i** The menu is left if a button is not pressed within 10 seconds. Changed settings are lost.



- ❑ Press the **Change** button until the desired spin speed or "Without final spin" is displayed.

Other settings can be selected by pressing the **Menu** button; the same settings can be changed by pressing the **Change** button.

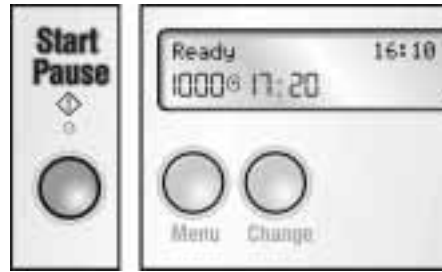

- ❑ Press the **Start/Pause** button. The programme starts. The indicator light is on (red).

- i** The individual programme steps are indicated in the display field.

## Programme finished at?

- i** Make sure that the time has been set – see "Set clock", Page 23.
- ❑ Turn the programme selector to the desired programme.
- ❑ Load the laundry and close the loading door. The "Start/Pause" indicator light flashes (red).

### Example:



- ❑ Press the "Menu" button until "Programme finished at" is displayed. Current end time flashes. The "Start/Pause" indicator light flashes (red).

- i** The menu is left if a button is not pressed within 10 seconds. Changed settings are retained.



- ❑ Press the "Change" button until the programme end time is displayed. The programme end can be set in 30 minute steps. The time can be programmed up to a maximum 24 hours in advance.

- i** The end time must be reset if the programme, additional options or the current time is changed.

If there is a small load of lightly soiled washing, the programme may end well before the selected end time.

If there is a large load of heavily soiled washing, the programme may end several minutes after the selected end time.

Other settings can be selected by pressing the **Menu** button; the same settings can be changed by pressing the **Change** button.





- Press the “Start/Pause” button. The delayed start is activated. The indicator light is on. “Time delay” is indicated in the display field.

## Wash

You can select among several wash options:

These are:

- “Normal Wash”  Usual wash duration.
  - “Quick Wash”  Reduced wash time for lightly soiled washing.
  - “Intensive Wash”  Extended wash time for heavily soiled washing.
- Turn the programme selector to the desired programme.
  - Load the laundry and close the loading door. The **Start/Pause** indicator light flashes (red).

### Example:

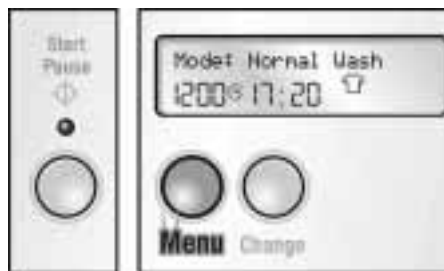

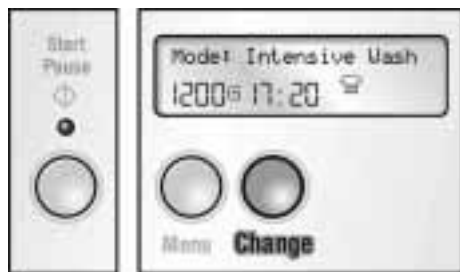

- Press the **Menu** button until “Normal Wash” is displayed. The “” symbol flashes. The **Start/Pause** indicator light flashes (red).

- i** The menu is left if a button is not pressed within 10 seconds. Changed settings are retained.



- Press **Change** button until the required wash option is displayed.

- i** If “Intensive Wash: on” or “Quick Wash: on” was selected, symbol “” or “” is permanently displayed when the menu is left.

Other settings can be selected by pressing the **Menu** button; the same settings can be changed by pressing the **Change** button.

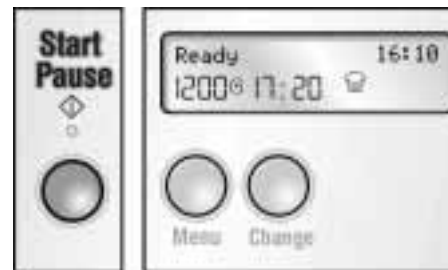

- Press the **Start/Pause** button. The programme starts. The indicator light is on.

- i** The individual programme steps are indicated in the display field.



## Signal

The acoustic signal indicates the start or end of the programme, operating errors or malfunctions.

You can specify the volume of the acoustic signal.

### Switching on, setting the volume and switching off the acoustic signal

- ❑ Turn the programme selector to the desired programme.
- ❑ Load the laundry and close the loading door.  
The **Start/Pause** indicator light flashes (red).

#### Example:

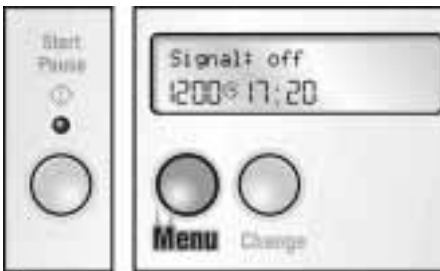

- ❑ Press the **Menu** button until "Signal: off" is displayed. The "🔊" symbol flashes. The **Start/Pause** indicator light flashes (red).
- i** "Ready" is displayed if the button is not pressed for 10 seconds. Changed settings are retained.

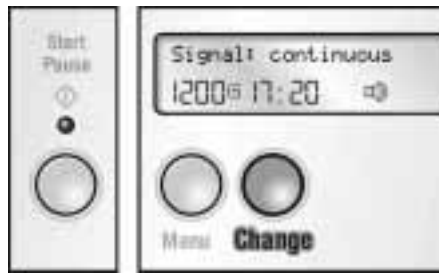

- ❑ Press the **Change** button until "Signal: continuous" is displayed.

If the **Change** button is held down, the volume of the acoustic signal is increased. Release the **Change** button when the required volume is reached.

- ❑ Hold down the **Change** button for longer than 10 seconds, "Signal: max." is displayed.
- ❑ Switch off signal: after "Signal: max" was displayed, hold down the **Change** button for longer than 10 seconds until "Signal: off" is displayed.

- i** The selected setting is retained after the wash cycle.

Other settings can be selected by pressing the **Menu** button; the same settings can be changed by pressing the **Change** button.

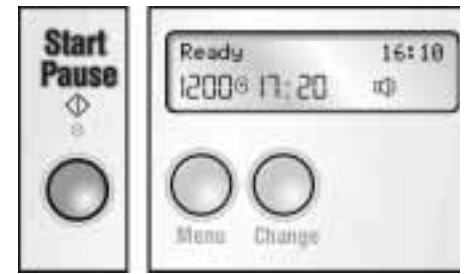

- ❑ Press the **Start/Pause** button. The programme starts. The indicator light is on.

- i** The individual programme steps are indicated in the display field.

## Childproof lock

You can secure your washing machine to prevent selected functions from being inadvertently changed.

If the childproof lock has been selected:

- No changes can be made while the programme is running,
- The door remains locked at the end of the programme,

### Activating the childproof lock

- ❑ Set programme selector to a programme in order to switch on the appliance.



- ❑ Press the **Menu** button until "Childproof lock: off" is displayed. The "→○" symbol flashes.



- ❑ Press the **Change** button until "Childproof lock: on" is displayed. When the menu is left, the "→○" symbol is permanently displayed.

- i** When a programme has started, you can activate/deactivate the childproof lock in pause mode only.

### Starting a programme with "Child lock: on"

- ❑ Turn the programme selector to the desired programme.
- ❑ Load the laundry and close the loading door. The **Start/Pause** indicator light flashes (red).



- ❑ Press and hold down the **Start/Pause** button (5 seconds). The programme starts. The indicator light is on (red). Childproof lock activated.

- i** To deactivate the childproof lock temporarily, press the **Start/Pause** button and hold down (5 seconds) until the **Start/Pause** indicator light flashes. You can change other settings. Press the **Start/Pause** button to activate the childproof lock.

- i** You can interrupt a running programme while the childproof lock is activated when the programme selector is set to "Off". Selected programme continues running if the appliance was switched on again.

### Remove washing at the end of the programme with "Child lock: on"

- ❑ Press and hold down the **Start/Pause** button (5 seconds). the washing machine door can be opened.
- ❑ Remove the washing. Childproof lock remains active even when the appliance is switched off.

- i** The childproof lock is reactivated the next time the appliance is switched on. Washing machine door cannot be opened. Further changes are not possible. Press the **Start/Pause** button and hold down (5 seconds) to open the door.

### Deactivate childproof lock

- ❑ Set the programme selector to the required programme in order to switch on the appliance.
- ❑ Press and hold down the **Start/Pause** button (5 seconds). The appliance is then in **pause** mode. Press the **Menu** button to deactivate the childproof lock. The "→○" symbol flashes.
- ❑ Press the **Change** button until "Childproof lock: off" is displayed.

- i** When a programme has started, you can activate/deactivate the childproof lock in pause mode only.

## Setting the time

You can set the current time.  
The settings are retained even if your washing machine is not used for up to 6 weeks.

- ❑ Turn the programme selector to the desired programme.

### Example:



- ❑ Press the **Menu** button until “Set clock:” is displayed. The hour display flashes. The **Start/Pause** indicator light flashes (red).

- i** The menu is left if a button is not pressed within 10 seconds. Changed settings are lost.



- ❑ Press the **Change** button until the hour display is correct.

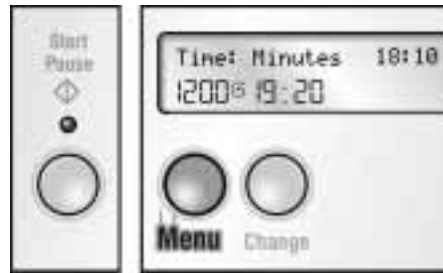

- ❑ Press the **Menu** button until the minute display flashes. The **Start/Pause** indicator light flashes (red).

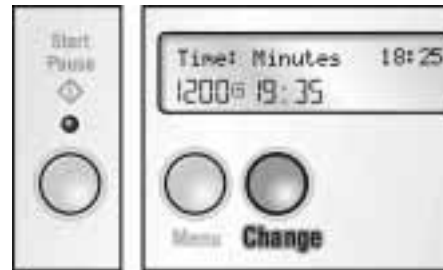

- ❑ Press the **Change** button until the minute display is correct. The time is now set.

- i** Press the **Menu** button, the menu function ends.

Other settings can be selected by pressing the **Menu** button; the same settings can be changed by pressing the **Change** button.

# During washing

## Select a programme again

- If the childproof lock is active, deactivate temporarily. See Page 22.
- Turn the programme selector to **Off**.
- Turn the programme selector to a newly selected programme. **Start/Pause** indicator light flashes.
- If required, change other settings. See Page 19.
- If required, activate childproof lock.
- Press the **Start/Pause** button. The programme starts. The indicator light is on.

## Topping up the washing/Interrupting the programme

You can put washing in the drum later, take washing out of the drum early or interrupt the programme at any time.

- i** It is not recommended to top up the washing after the wash phase has started.

### Without childproof lock

- i** You can top up or reduce washing as long as the **Start/Pause** indicator light is on (red).
- Press the **Start/Pause** button. In the display field are indicated in succession: "Pause", "Top up possible".

- Open the door.
- Insert/remove washing.
- Close the door.
- Press the **Start/Pause** button. Programme continues. The indicator light is on (red).
- i** If the **Start/Pause** indicator light is on (red), the programme can be interrupted, however the door cannot be opened for reasons of safety (water level, temperature or speed too high).  
In the display field are indicated in succession: "Pause", "No top-up".

- i** If the speed is too high, the **Start/Pause** indicator light comes on (red). The door can be opened in pause mode as soon as the drum has stopped.

### Childproof lock activated

- Press the **Start/Pause** button and hold down (5 seconds), childproof lock is deactivated and the programme can be interrupted.
- i** If the **Start/Pause** indicator light flashes (red), the door cannot be opened for reasons of safety (water level, temperature or speed too high).  
In the display field are indicated in succession: "Pause", "No top-up".
- i** If the **Start/Pause** indicator light flashes (red), the washing can be topped up or removed prematurely.

In the display field are indicated in succession: "Pause", "Top up possible".

- Open the door.
- Insert/remove washing.
- Close the door.
- Press the **Start/Pause** button. Programme continues. Childproof lock activated. The indicator light is on (red).

## Cancelling active programme

If you would like to terminate a programme and remove the washing:

- If the childproof lock is active, press the **Start/Pause** button and hold down (5 seconds).
- Turn the programme selector to **Drain** or **Spin**.
- i** If a programme was interrupted at a high temperature, the washing machine door may remain locked until the appliance has cooled down.
- If the childproof lock is active, press the **Start/Pause** button and hold down (5 seconds).
- Press the **Start/Pause** button.
- Wait until programme ends.
- Open the door.
- Remove the washing.
- i** If a programme was interrupted at a high temperature, the washing machine door may remain locked until the appliance has cooled down.
- i** If the programme is terminated by switching off the appliance, the door may remain locked.

# After washing

The **Start/Pause** indicator light goes out.

Display field: "Remove washing".



- Open the door.

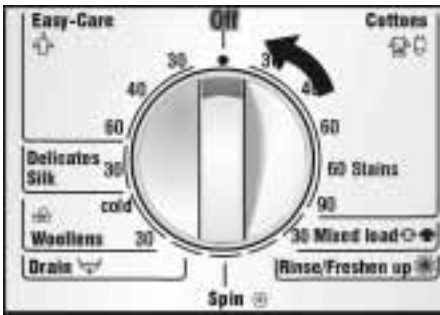

- Turn the programme selector to **Off**.

## "Without final spin" selected

**Start/Pause** indicator light flashes.  
Display field: "Start or Drain".

or

- If required, change the spin speed; see from Page 19.
- Press the **Start/Pause** button. The programme starts. The programme progress is indicated in the display field. The indicator light is on.

or

- Turn the programme selector to **Drain**. **Start/Pause** indicator light flashes.
- Press the **Start/Pause** button. The indicator light is on. Display field: "Drain".
- When the additional programme has ended, open the door.

- Turn the programme selector to **Off**.

## "Child lock: ON" preselected

The **Start/Pause** indicator light comes on (red).

Display field: "Remove washing".

- Press and hold down the **Start/Pause** button (5 seconds) until "Pause" is displayed. The **Start/Pause** indicator light flashes (red).
- Open the door.
- Turn the programme selector to **Off**.

## Ending washing



- Close the mains water tap.



- Remove the washing.
- i** The childproof lock is reactivated the next time the appliance is switched on.
- Leave the washing machine door open to allow the interior of the washing machine to dry.



# Maintenance and care information

## Cleaning and Care

### ⚠ Risk of electric shock!

Always disconnect the appliance from the mains before cleaning. Never clean the washing machine with a water jet.

### ⚠ Risk of explosion!

Never clean the appliance with solvents.

## Cleaning the appliance housing and control panel

If required:

- ❑ Use hot soapy water or a mild, non-abrasive cleaning agent.
- ❑ Rub dry with a soft towel.

## Cleaning the drum

In the event that rust spots have formed due to left over debris (e.g.coins, paper clips, needles, nails):

- ❑ Use cleaning products with chlorine bleach. Follow manufacturer's instructions. Never use steel wool.

## Cleaning the detergent dispenser

If there are detergent or cleaning product residues in the detergent drawer:

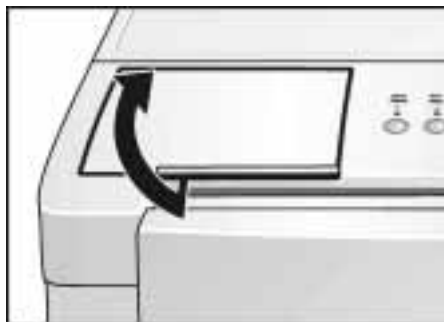

- ❑ Open the detergent drawer.

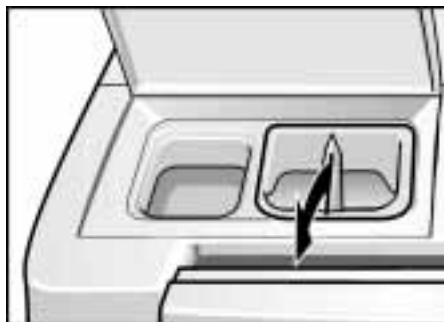

- ❑ Pull out the detergent drawer slightly and remove.
- ❑ Clean the detergent dispenser and insert under running water. This can be divided into two parts.

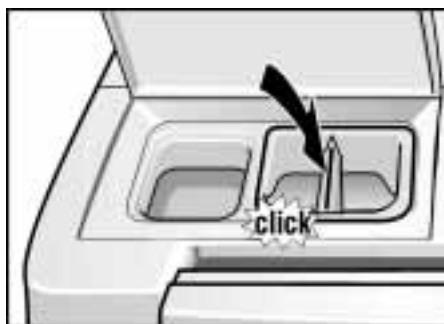

- ❑ Slide in the detergent drawer.

## Cleaning water inlet strainers

This is necessary if very little or no water flows into the washing machine.

### Release the water pressure in the supply hose

- ❑ Turn off the tap.
- ❑ Turn the programme selector to any programme (except **Spin / Drain**).
- ❑ Press **Start/Pause** button and wait for "Water tap closed?" message.
- ❑ Turn the programme selector to **Off**.

### Cleaning the strainer(s) at the water tap



- ❑ Remove the hose from the tap.
- ❑ Rinse the strainer under flowing water.
- ❑ Connect the hose.



## Cleaning the strainers on the washing machine

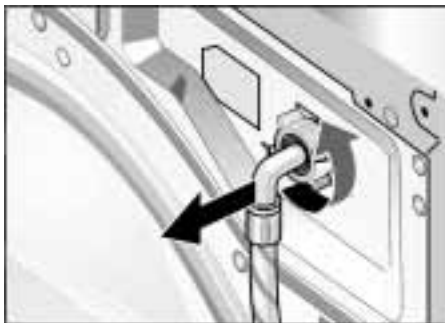

- Disconnect the hose from the back of the washing machine.

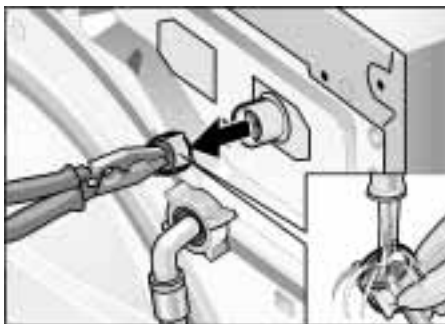

- Pull out the strainer and rinse under running water.
- Insert the strainer and reconnect the hose.
- Turn on the water tap and check whether water is still discharged. If water is leaking, check that the filter is correctly seated.
- Turn off the tap.

## Descaling the washing machine

Provided that you use the correct amount of detergent, it is not necessary to descale the washing machine.

Rust spots caused by metal parts left on the inside of the drum can be removed by using descaler.

If, however, descaling the appliance becomes necessary, please follow the instructions provided by the descaling agent manufacturer.

# Troubleshooting Minor Faults

If repairs are needed, and assuming that you cannot eliminate the fault yourself with the aid the following table

- ❑ Turn the programme selector to **Off**.
- ❑ Disconnect the washing machine from the power supply.
- ❑ Turn off the tap.
- ❑ Call customer service, see Page 32.

Fault	Possible cause	Remedial action
Washing machine door cannot be opened.	“Without final spin” selected.	Select <b>Drain</b> or <b>Spin</b> .
	Childproof lock activated.	Deactivate childproof lock, see Page 22.
	Power failure.	An interrupted programme will be resumed when the power returns. If the washing is to be removed during the power failure, call customer service, see Page 32.
	Programme is running and/or washing machine door is locked for safety reasons.	Wait until the programme ends; see Page 25.
	Plug is loose or not plugged in.	Eliminate cause.
Washing machine door cannot be opened even though the appliance has been switched off and on again.	Programme selector turned to <b>Off</b> before end of programme.	Select a programme.
	Childproof lock activated.	Deactivate childproof lock, see Page 29.
Programme continues running even though the appliance has been switched off and on again.	The washing machine door is locked for safety reasons because the water level, the temperature or the speed is too high.	See “Topping up the washing/Interrupting the programme”, Page 24.
	Childproof lock activated.	Deactivate childproof lock, see Page 22.
Appliance cannot be operated. “Child lock activated” is indicated in the display field.	Childproof lock activated.	Deactivate childproof lock, see Page 22.
	A fuse has triggered.	Switch on/replace the fuse.
Control lights do not come on.	Power failure.	If the fault recurs, call Customer Service.
		An interrupted programme will be resumed when the power returns. If the washing is to be removed during the power failure, call customer service, see Page 32.

<b>Fault</b>	<b>Possible cause</b>	<b>Remedial action</b>
Programme does not start. Start/Pause indicator light flashes.	<b>Start/Pause</b> button not pressed.	Press the <b>Start/Pause</b> button.
Programme does not start. “Door open?” indicated in the display field.	Door not closed properly.	Check whether laundry is trapped in door. Close the loading door (a click should be heard). Programme continues.
“Press start” is indicated in the display field.	End time selected but still not activated by pressing the <b>Start/Pause</b> button.	Press the <b>Start/Pause</b> button.
Programme does not start. “Time delay” is indicated in the display field.	End time selected and activated.	None. Appliance starts automatically.
Time cannot be set.	Programme has already started; when the programme has started, the time cannot be set.	Wait until programme ends.
“Set clock.” text remains in the display field even though the <b>Menu</b> button has been pressed.	The setting has switched from hours to minutes; both selection points have the same text.	See “Set clock”, Page 23.
Time is not displayed.	Time not set.	Set clock; see Page .
End time cannot be selected.	Time not set. Programme has already started; when the programme has started, the time cannot be set.	Set clock; see Page 23. Before starting the programme, select and start the desired end time, see Page 19.
Spin speed cannot be selected.	Spin cycle is already running; the speed cannot be changed during the spin cycle. Programme selector is set to <b>Drain</b> ; spinning is not possible with this programme.	Select speed before spinning. If required, select another programme.
Childproof lock cannot be selected.	The programme has already started.	Childproof lock can be selected in pause mode.
Detergent residue in the detergent dispensers.	Damp or lumpy detergent.	Clean and dry the detergent dispenser; see Page 26. Use the cap to measure the liquid detergent.
Water does enter the machine or detergent is not washed away. “Water tap closed?” indicated in the display field.	Mains water tap is not opened. Inlet hose kinked or pinched. Strainers in supply hose clogged. Water pressure too low.	Turn the tap on. Programme continues. Eliminate cause. Clean the strainers; see Page 26. Eliminate cause.
Water not visible in the drum.	Not a fault. The water lies below the visible part of the drum.	
Washing solution is not completely drained. “Pump blocked?” indicated in the display field.	Drainage pipe and/or drainage hose blocked.	Clean drainage pipe and/or drainage hose.
Water runs out from under the appliance.	Screw fitting of the inlet hose is leaking. Drainage hose is leaking.	Tighten the screw-fitting. Replace the drain hose.

<b>Fault</b>	<b>Possible cause</b>	<b>Remedial action</b>
Foam comes out of the detergent drawer.	Too much detergent.	Add 1 tbs. of fabric softener to ½ litre of water and pour into dispenser <b>II</b> . Reduce the detergent dosage for the next wash cycle.
<b>Repeat</b> spin cycle.	This is not a fault. Unbalanced load detection system is attempting to compensate the imbalance by spinning the washing several times.	Always load large <b>and</b> small items together into the drum.
The laundry was not spun.	Large laundry items have become entangled and are not evenly distributed in the drum. For reasons of safety the high speed spin cycle was automatically suppressed.	Always load large <b>and</b> small items together into the drum.
Programme duration extended.	This is not a fault. The foam detection feature has activated an additional rinsing cycle to reduce the amount of foam.	Dispensing the correct amount of detergent
	This is not a fault. Unbalanced load detection system is attempting to compensate the imbalance by spinning the washing several times.	Always load large <b>and</b> small items together into the drum.
Poor wash result.	Soiling is greater than expected.	Select suitable programme. or <b>Intensive Wash</b> additional option.
	Detergent underdosed.	Dose detergent according to the manufacturer's instructions.
Detergent residue on the washing.	Some phosphate-free detergents contain water-insoluble residues that may appear as light spots on the laundry.	Brush out the washing after drying.
Grey residue on the washing.	Soiling caused by ointment, grease or oil.	Select maximum detergent dosage and maximum permitted temperature for the next wash cycle.

## Fault displays

<b>Text on display panel</b>	<b>Possible cause</b>	<b>Remedial action</b>
Tap closed?	Mains water tap is not opened.	Turn the tap on. Programme continues.
	Inlet hose kinked or pinched.	Eliminate cause.
	Filter blocked in water inlet hose.	Clean the strainer; see from Page 26.
	Water pressure too low.	Eliminate cause.
"Pump blocked?"	Drainage pipe and/or drainage hose blocked.	Clean drainage pipe and/or drainage hose.
"Door open?"	Door not closed properly.	Check whether laundry is trapped in door. Close the door.

If the fault cannot be rectified with the aid of the above table: switch off the appliance, wait 5 seconds, then switch on the appliance, select and start the programme.

If the fault recurs, call Customer Service, see Page 32.

# Consumption values

Cancelling the programme	Additional option	Load up to	Consumption values **		
			Power	Water	Duration
Cottons 40	Intensive Wash	9.0 kg	1.2 kWh	95 l	2:00 h
Cottons 60	Intensive Wash	9.0 kg	1.6 kWh	95 l	2:30 h
Cottons 60 Stains*	Intensive Wash	9.0 kg	1.5 kWh	72 l	2:30 h
Cottons 60	–	8.0 kg	1.5 kWh	95 l	2:10 h
Cottons 90	Intensive Wash	9.0 kg	3.2 kWh	110 l	3:40 h
Easy-Care 40*	Intensive Wash	4.0 kg	0.5 kWh	80 l	1:10 h
Mixed load 30	Intensive Wash	4.0 kg	0.6 kWh	40 l	1:00 h
Delicates 30 °C	Intensive Wash	3.0 kg	0.4 kWh	45 l	0:50 h
Hand wash/ Woollens 30		2.5 kg	0.4 kWh	32 l	0:30 h

\* Programme setting with “Intensive Wash” additional option for conducting test in compliance with EN 60456 60456 and IEC 60 456

\*\* 9 kg load is recommended only in combination with the “Intensive Wash” option.

\*\* Consumption values will differ from the indicated values depending on the water pressure, water hardness, water inlet temperature, ambient temperature, type and quantity of washing and degree of soiling, utilised detergent, fluctuations in the mains voltage and selected additional options.

**All values are subject to change depending on progress in the area of development.**

# Customer service

Your washing machine does not require special care than that already mentioned.

Before you call customer service, please check whether you can eliminate the fault yourself (see from Page 35).

A technician who is called out to give advice will charge you, even if the appliance is still under guarantee.

Your nearest Customer Service centre can be found in the index supplied.

Please provide customer service with the product number (E-Nr.) and the production number (FD) of the appliance. In specifying the product number and production number of your appliance, you help us in our attempt to prevent unnecessary travelling and the associated extra costs.

You can find this information on the appliance rating plate (see picture) and in the box marked in bold outline on the appliance plate at the back of the appliance.





# Installing, connecting and transporting the appliance

## Safety instructions

### ⚠ Risk of injury!

The washing machine is very heavy. Lift with caution.

### Warning

Frozen hoses may tear/burst. Do not install the washing machine in areas where there is a risk of frost or outdoors.

The washing machine may be damaged. Do not lift the washing machine by its projecting parts (e. g. door).

In addition to the safety information listed here, the local water and electricity supplier may have special requirements.

If in doubt, have the appliance connected by a specialist.

## Transport, e.g. when moving

Before transporting the washing machine

- Turn off the tap.
- Disconnect the washing machine from the mains.
- Dismantle the supply and drainage hoses,
- Preparing and inserting the transport bolts

- i** Having transported the appliance and ensured proper installation and connection, allow the **Drain** programme to run through before starting the first wash programme.

## Preparing and inserting the transport bolts

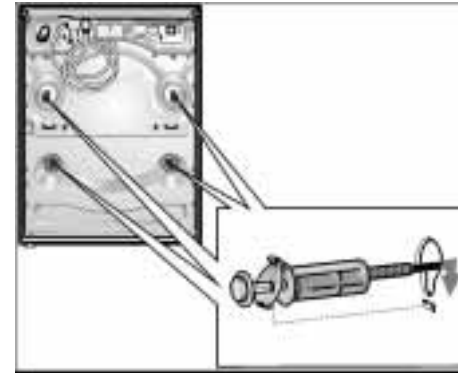

- Remove the lower covers.
- Prepare the transport bolts: Loosen the screw in the sleeve until the end of the screw is level with the end of the sleeve.
- Insert the transportation protection devices and tighten the bolts. The lug on the washer must be located in the groove in the rear panel of the housing.

# Quick-reference instructions

## Before use

### ⚠ Warning

Before using your washing machine, read the installation and operating instructions and act accordingly.

- ❑ Select the display language.
- ❑ Set the time.

## Preparing the washing

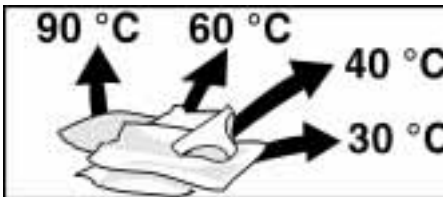
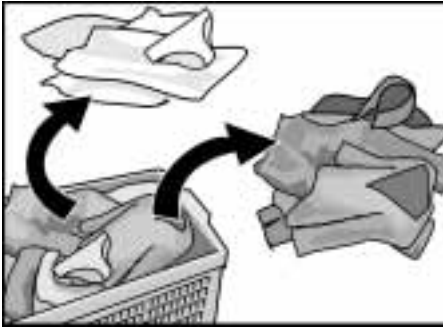

Load

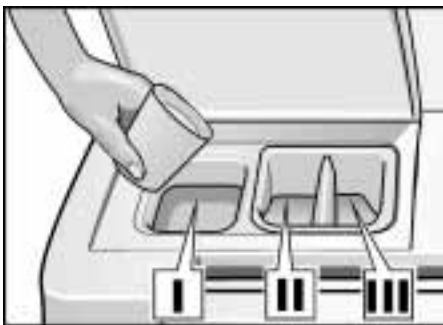

Open

## Select and start a programme

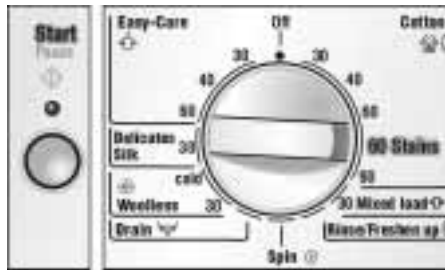
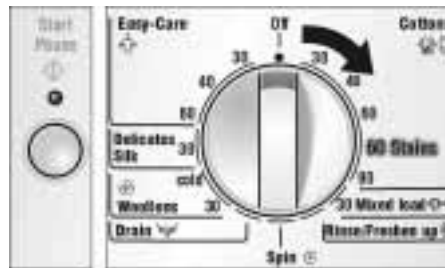

## Select required settings...

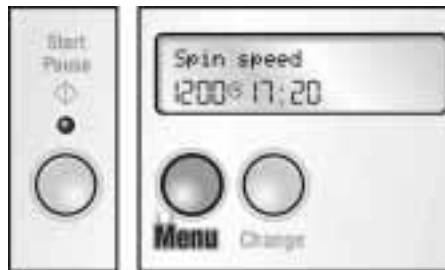

## ... and start



## After washing



Close



Remove the washing