

Some of the contents in this manual may differ from your phone depending on the software of the phone or your service provider.

Printed in Korea
Code No.:GH68-XXXXXA
English. 01/2008. Rev. 1.0

© Vodafone Group 2007. Vodafone, the Vodafone logos, and Vodafone live! are trade marks of the Vodafone Group. Other product and company names mentioned herein may be the trade marks of their respective owners.



User Manual SGH-J700V

Only for Marketing



using this manual

This user manual has been specially designed to guide you through the functions and features of your mobile phone. To get started quickly, refer to "introducing your mobile phone," "assembling and preparing your mobile phone," and "using basic functions."

Instructional icons

Before you start, familiarise yourself with the icons you will see in this manual:



WARNING

Warning— situations that could cause injury to yourself or others



CAUTION

Caution— situations that could cause damage to your phone or other equipment



Note— notes, usage tips, or additional information



Refer to— pages with related information; for example: ► p.12 (represents "see page 12")

- **Followed by**— the order of options or menus you must select to perform a step; for example: Press <Menu> → Messages → Create new message (represents Menu, followed by Messages, followed by Create new message)
- [] **Square brackets**— phone keys; for example: [Ⓜ] (represents the Power Menu exit key)
- < > **Angled brackets**— softkeys that control different functions at each screen; for example: <OK> (represents the OK softkey)

Copyright information

Rights to all technologies and products that comprise this device are the property of their respective owners:

- Bluetooth® is a registered trademark of the Bluetooth SIG, Inc. worldwide— Bluetooth QD ID: B0XXXXXX.
- Java™ is a trademark of Sun Microsystems, Inc.
- Pixel™ and Pixel Viewer™ are trademarks of Pixel Technologies, Inc.

contents

safety and usage information	2
Safety warnings	2
Safety precautions	4
Important usage information	7
introducing your mobile phone	10
Unpack	10
Phone layout	11
Keys	12
Display	13
Icons	13
assembling and preparing your mobile phone	15
Install the SIM card and battery	15
Charge the battery	17
Insert a memory card (optional)	18
using basic functions	19
Turn your phone on and off	19
Access menus	20

Customise your phone	20	Edit images	40
Use basic call functions	21	Use Java-powered games and applications ...	42
Send and view messages	22	View world clocks	42
Add and find contacts	25	Set and use alarms	43
Use basic camera functions	26	Use the calculator	44
Listen to music	27	Convert currencies or measurements	44
Browse the web	28	Set a countdown timer	45
using advanced functions	30	Use the stopwatch	45
Use advanced call functions	30	Create a text memo	45
Use advanced Phonebook functions	32	Manage your calendar	46
Use advanced messaging functions	33	overview of menu functions	a
Use advanced music functions	34	troubleshooting	b
using tools and applications	36	index	e
Use the Bluetooth wireless feature	36		
Activate and send an SOS message	37		
Activate mobile tracker	38		
Record and play voice memos	39		

safety and usage information

Comply with the following precautions to avoid dangerous or illegal situations and ensure peak performance of your mobile phone.



Safety warnings

Keep your phone away from small children and pets

Keep your phone and all accessories out of the reach of small children or animals. Small parts may cause choking or serious injury if swallowed.

Protect your hearing



Listening to a headset at high volumes can damage your hearing. Use only the minimum volume setting necessary to hear your conversation or music.

Install mobile phones and equipment with caution

Ensure that any mobile phones or related equipment installed in your vehicle are securely mounted. Avoid placing your phone and accessories near or in an air bag deployment area. Improperly installed wireless equipment can cause serious injury when airbags inflate rapidly.

Handle and dispose of batteries and chargers with care

- Use only Samsung-approved batteries and chargers specifically designed for your phone. Incompatible batteries and chargers can cause serious injuries or damage to your phone.
- Never dispose of batteries in a fire. Follow all local regulations when disposing used batteries.

- Never place batteries or phones on or in heating devices, such as microwave ovens, stoves, or radiators. Batteries may explode when overheated.
- Never crush or puncture the battery. Avoid exposing the battery to high external pressure, which can lead to an internal short circuit and overheating.

Avoid interference with pacemakers

Maintain a minimum of 15 cm (6 inches) between mobile phones and pacemakers to avoid potential interference, as recommended by manufacturers and the independent research group, Wireless Technology Research. If you have any reason to suspect that your phone is interfering with a pacemaker or other medical device, turn off the phone immediately and contact the manufacturer of the pacemaker or medical device for guidance.

WARNING

Turn off the phone in potentially explosive environments

Do not use your phone at refuelling points (service stations) or near fuels or chemicals. Turn off your phone whenever directed by warning signs or instructions. Your phone could cause explosions or fire in and around fuel or chemical storage and transfer areas or blasting areas. Do not store or carry flammable liquids, gases, or explosive materials in the same compartment as the phone, its parts, or accessories.

Reduce the risk of repetitive motion injuries

When sending text messages or playing games on your phone, hold the phone with a relaxed grip, press the buttons lightly, use special features that reduce the number of buttons you have to press (such as templates and predictive text), and take frequent breaks.



CAUTION

Safety precautions

Drive safely at all times

Avoid using your phone while driving and obey all regulations that restrict the use of mobile phones while driving. Use hands-free accessories to increase your safety when possible.

Follow all safety warnings and regulations

Comply with any regulations that restrict the use of a mobile phone in a certain area.

Use only Samsung-approved accessories

Using incompatible accessories may damage your phone or cause injury.

Turn off the phone near medical equipment

Your phone can interfere with medical equipment in hospitals or health care facilities. Follow all regulations, posted warnings, and directions from medical personnel.

Turn off the phone or disable the wireless functions when in an aircraft

Your phone can cause interference with aircraft equipment. Follow all airline regulations and turn off your phone or switch to a mode that disables the wireless functions when directed by airline personnel.

Protect batteries and chargers from damage

- Avoid exposing batteries to very cold or very hot temperatures (below 0°C / 32°F or above 45°C / 115°F). Extreme temperatures can reduce the charging capacity and life of your batteries.
- Prevent batteries from contacting metal objects, as this can create a connection between the + and - terminals of your batteries and lead to temporary or permanent battery damage.
- Never use a damaged charger or battery.
- Risk of explosion if battery is replaced by an incorrect type. Dispose of used batteries according to the instructions

Handle your phone carefully and sensibly

- Do not allow your phone to get wet - liquids can cause serious damage. Do not handle your phone

CAUTION

with wet hands. Water damage to your phone can void your manufacturer's warranty.

- Avoid using or storing your phone in dusty, dirty areas to prevent damage to moving parts.
- Your phone is a complex electronic device—protect it from impacts and rough handling to avoid serious damage.
- Do not paint your phone, as paint can clog moving parts and prevent proper operation.
- Avoid using the phone's camera flash or light close to the eyes of children or animals.
- Your phone and memory cards may be damaged by exposure to magnetic fields. Do not use carrying cases or accessories with magnetic closures or allow your phone to come in contact with magnetic fields for extended periods of time.

Avoid interference with other electronic devices

Your phone emits radio frequency (RF) signals that may interfere with unshielded or improperly shielded electronic equipment, such as pacemakers, hearing aids, medical devices, and other electronic devices in homes or vehicles. Consult the manufacturers of your electronic devices to solve any interference problems you experience.

CAUTION



Important usage information

Use your phone in the normal position

Avoid contact with your phone's internal antenna.

Allow only qualified personnel to service your phone

Allowing unqualified personnel to service your phone may result in damage to your phone and will void your warranty.

Ensure maximum battery and charger life

- Avoid charging batteries for more than a week, as overcharging may shorten battery life.
- Over time, unused batteries will discharge and must be recharged before use.

- Disconnect chargers from power sources when not in use.
- Use batteries only for their intended purpose.

Handle SIM cards and memory cards with care

- Do not remove a card while the phone is transferring or accessing information, as this could result in loss of data and/or damage to the card or phone.
- Protect cards from strong shocks, static electricity, and electrical noise from other devices.
- Frequent writing and erasing will shorten the life span of memory cards.
- Do not touch gold-coloured contacts or terminals with your fingers or metal objects. If dirty, wipe the card with a soft cloth.

Ensure access to emergency services

Emergency calls from your phone may not be possible in some areas or circumstances. Before travelling in remote or undeveloped areas, plan an alternate method of contacting emergency services personnel.

Specific Absorption Rate (SAR) certification information

Your phone conforms to European Union (EU) standards that limit human exposure to radio frequency (RF) energy emitted by radio and telecommunications equipment. These standards prevent the sale of mobile phones that exceed a maximum exposure level (known as the Specific Absorption Rate, or SAR) of 2.0 watts per kilogram of body tissue.

During testing, the maximum SAR recorded for this model was **0.499** watts per kilogram. In normal use,

the actual SAR is likely to be much lower, as the phone has been designed to emit only the RF energy necessary to transmit a signal to the nearest base station. By automatically emitting lower levels when possible, your phone reduces your overall exposure to RF energy.

The Declaration of Conformity at the back of this manual demonstrates your phone's compliance with the European Radio & Terminal Telecommunications Equipment (R&TTE) directive. For more information about the SAR and related EU standards, visit the Samsung mobile phone website.

Correct disposal of this product

(Waste Electrical & Electronic Equipment)



(Applicable in the European Union and other European countries with separate collection systems)

This marking shown on the product or its literature, indicates that it should not be disposed with other household wastes at the end of its working life. To prevent possible harm to the environment or human health from uncontrolled waste disposal, please separate this from other types of wastes and recycle it responsibly to promote the sustainable reuse of material resources.

Household users should contact either the retailer where they purchased this product, or their local government office, for details of where and how they can take this item for environmentally safe recycling.

Business users should contact their supplier and check the terms and conditions of the purchase contract. This product should not be mixed with other commercial wastes for disposal.

introducing your mobile phone

In this section, learn about your mobile phone's layout, keys, display, and icons.

Unpack

Check your product box for the following items:

- Mobile phone
- Battery
- Travel adapter (charger)
- User manual



The items supplied with your phone may vary depending on the software and accessories available in your country or offered by your service provider.

You can obtain additional accessories from your local Samsung dealer.

Phone layout

The front of your phone includes the following keys and features:



The rear of your phone includes the following keys and features:

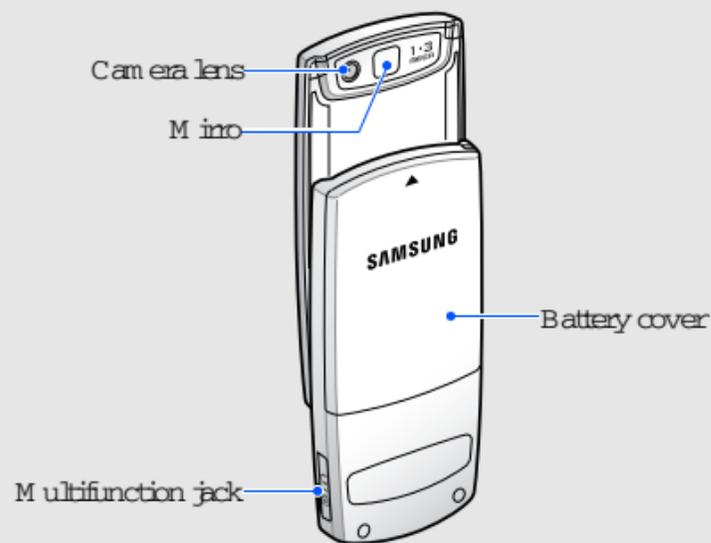

Closing the phone automatically locks the exposed keys to prevent you from accidentally pressing them. To unlock these keys, press <Unlock> → <OK>.

Keys

Key	Function
 Softkeys	Perform actions indicated at the bottom of the display
 Navigation	In Idle mode, access user-defined menus (left/right/up/down); In Menu mode, scroll through menu options
 Centre	In Idle mode, access Menu mode; In Menu mode, select the highlighted menu option or confirm an input
 Dial	Make or answer a call; In Idle mode, retrieve recently dialed, missed, or received numbers
 Delete	Delete characters or items in an application

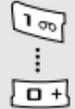
Key	Function
 Power/ Menu exit	Switch the phone on and off (press and hold); End a call; In Menu mode, cancel input and return to Idle mode
 Alphanumeric	Enter numbers, letters and special characters; In Idle mode, press and hold [1] to access voice mails and [0] to enter an international call prefix
 Special function	Enter special characters or perform special functions; In Idle mode, press and hold [#] for Silent profile; Press and hold [*] to enter a pause between numbers
 Volume	Adjust the phone's volume

Display

Your phone's display consists of three areas:

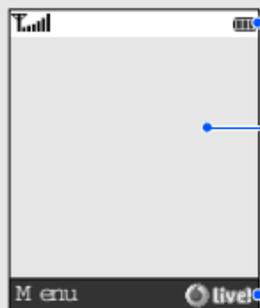

Icon line

Displays various icons

Text and graphic area

Displays messages, instructions, and information you enter

Softkey line

Displays the current actions assigned to each softkey

Icons

Learn about the icons that appear on your display.

Icon	Definition
	Signal strength
	GPRS network status <ul style="list-style-type: none">Blue: GPRS network connectedRed: Transferring data via GPRS network
	EDGE network status <ul style="list-style-type: none">Blue: EDGE network connectedRed: Transferring data via EDGE network
	Call in progress
	No service available
	SMS message feature activated
	Memory card inserted
	Alarm activated

Icon	Definition
	Roaming (outside of normal service area)
	Call diverting activated
	In Home Zone service area
	In Office Zone service area
	Bluetooth activated
	Bluetooth hands-free car kit or headset connected
	Normal profile activated
	Silent profile activated
	Driving profile activated
	Meeting profile activated
	Outdoor profile activated
	Offline profile activated

Icon	Definition
	User created profile activated
	Whisper mode activated (during a call)
	Mute mode activated (during a call)
	New text message (SMS)
	New multimedia message (MMS)
	New email message
	New voice mail message
	FM radio on
	Battery power level

assembling and preparing your mobile phone

Get started by assembling and setting up
your mobile phone for its first use.

Install the SIM card and battery

When you subscribe to a cellular service, you will receive a Subscriber Identity Module, or SIM card, with subscription details, such as your personal identification number (PIN) and optional services.

To install the SIM card and battery,

1. Remove the battery cover.

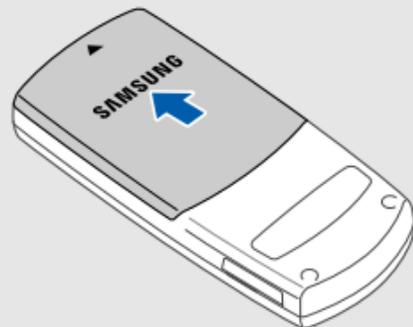

If the phone is on, press and hold [power] to turn it off.

2. Insert the SIM card.

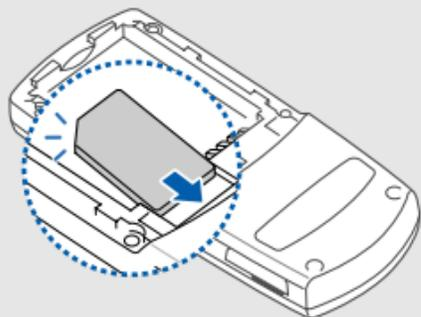

Place the card in the phone with the gold-coloured contacts facing down.

3. Insert the battery.

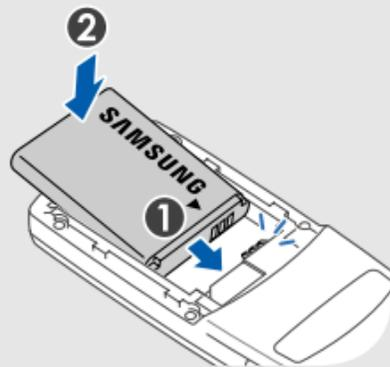

4. Replace the battery cover.

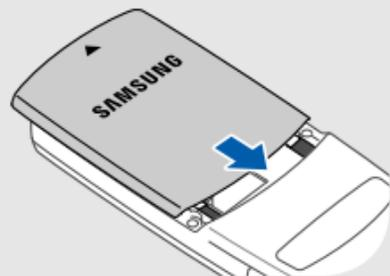

Charge the battery

Before using the phone for the first time, you must charge the battery.

1. Open the cover to the multifunction jack on the side of the phone.

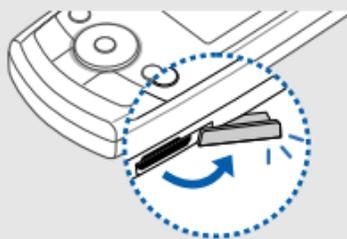

2. Plug the small end of the travel adapter into the jack.

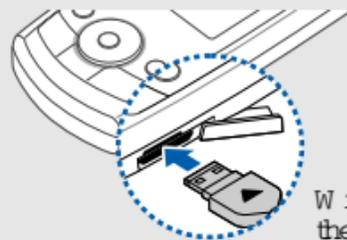

With the triangle facing the front of your phone



Improperly connecting the adapter can cause serious damage to the phone. Any damages by misuse are not covered by the warranty.

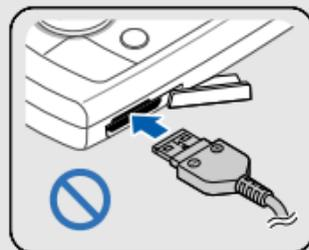
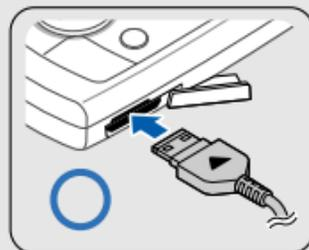

3. Plug the large end of the travel adapter into a power outlet.
4. When the battery is fully charged (the  icon is no longer moving), unplug the travel adapter from the power outlet.
5. Unplug the adapter from the phone.
6. Close the cover to the multifunction jack.



About the low battery indicator

When your battery is low, the phone will emit a warning tone and a low battery message. The battery icon will also be empty and blinking. If the battery level becomes too low, the phone will automatically power off. Recharge your battery to continue using your phone.

Insert a memory card (optional)

To store additional multimedia files, you must insert a memory card. Your phone accepts microSD™ memory cards up to 2 GB (depending on memory card manufacturer and type).

1. Open the cover to the memory card slot on the side of the phone.

2. Insert a memory card with the label side facing up.



3. Push the card in the slot until it locks in place.

To remove the memory card, push it gently until it disengages from the phone, and then pull the card out of the slot.

using basic functions

Learn how to perform basic operations and use the main features of your mobile phone.

Turn your phone on and off

To turn your phone on,

1. Slide open the phone.
2. Press and hold .
3. Enter your PIN and press <OK> (if necessary).

To turn your phone off, repeat steps 1 and 2 above.

Switch to Offline profile

By switching to Offline profile, you can use your phone's non-network services in areas where wireless devices are prohibited, such as aeroplanes and hospitals.

To switch to Offline profile, press <Menu> → Settings → Phone settings → Phone profiles → Offline.



Follow all posted warnings and directions from official personnel when in areas where wireless devices are prohibited.

Access menus

To access your phone's menus,

1. Press a softkey for the menu you want.
2. Use the navigation key to scroll to a menu or option.
3. Press <Select>, <OK>, or the Centre key to confirm the highlighted option.
4. Press <Back> to move up one level; Press [↶] to return to Idle mode.

Customise your phone

Get more from your phone by customising it to match your preferences.

Adjust the volume of the key tones

In Idle mode, press the Volume key up or down to adjust the key tone volume.

Switch to or from Silent profile

In Idle mode, press and hold [#] to silence or unsilence your phone.

Change your ringtone

1. In Idle mode, press <Menu> → Settings → Phone settings → Phone profiles.
2. Scroll to a profile.
3. Press <Options> → Edit → Voice call ringtone.
4. Select a ringtone category → a ringtone.
5. Press <Options> → Save profile.

Select a wallpaper (Idle mode)

1. In Idle mode, press <Menu> → Settings → Display settings → Home screen.
2. Select Wallpaper → an image category → an image.
3. Press <Save> .

Select a skin colour (Menu mode)

1. In Idle mode, press <Menu> → Settings → Display settings → My theme.
2. Select a colour pattern.

Set menu shortcuts

1. In Idle mode, press <Menu> → Settings → Phone settings → Shortcuts.
2. Select a key to use as a shortcut.
3. Select a menu to assign to the shortcut key.

Lock your phone

1. In Idle mode, press <Menu> → Settings → Security settings → Phone lock.
2. Select On.
3. Enter a new 4- to 8-digit password and press <OK> .
4. Enter the new password again and press <OK> .

Use basic call functions

Learn to make or answer calls and use basic call functions.

Make a call

1. In Idle mode, enter an area code and a phone number.
2. Press [] to dial the number.
3. To end the call, press [] .

Answer a call

1. When a call comes in, press [].
2. To end the call, press [].

Adjust the volume

To adjust the volume during a call, press the Volume key up or down.

Use the speakerphone feature

1. During a call, press the Centre key → <Yes> to activate the speaker.
2. To switch back to the earpiece, press the Centre key again.

Use the headset

By connecting the supplied headset to the multifunction jack, you can make and answer calls:

- To redial the last call, press the headset button, and then press again and hold.
- To answer a call, press and hold the headset button.
- To end a call, press and hold the headset button.

Send and view messages

Learn to send and view text (SMS), multimedia (MMS), and email messages.

Send a text message

1. In Idle mode, press <Menu> → Messages → Create new message → Text message.
2. Enter your message text. ► p. 24

3. Press <Options> → **Send**.
4. Enter a destination number.
5. Press the Centre key to send the message.

Send a multimedia message

1. In Idle mode, press <Menu> → Messages → Create new message → Multimedia message.
2. Select Subject.
3. Enter a subject and press the Centre key.
4. Select Image or video or Music or sound.
5. Add an image, a video, music, or sound.
6. Select Text.
7. Enter your message text and press the Centre key.
8. Press <Options> → Send.
9. Enter a destination number or an email address.
10. Press the Centre key to send the message.

Send an email

1. In Idle mode, press <Menu> → Messages → Create new message → Email.
2. Select Subject.
3. Enter a subject and press the Centre key.
4. Select Message.
5. Enter your email text and press the Centre key.
6. Select File attach.
7. Attach multimedia files.
8. Press <Options> → Send.
9. Enter an email address.
10. Press the Centre key to send the message.

Enter text

When entering text, you can change the text input mode:

- Press and hold [*] to switch between T9 and ABC modes.
- Press [*] to change case or switch to Number mode.
- Press and hold [#] to switch to Symbol mode.

Enter text in one of the following modes:

Mode	Function
ABC	Press the appropriate alphanumeric key until the character you want appears on the display.
T9	<ol style="list-style-type: none"> 1. Press the appropriate alphanumeric keys to enter an entire word. 2. When the word displays correctly, press [#] to insert a space. If the correct word does not display, press [0] to select an alternative word.
Number	Press the appropriate alphanumeric key to enter a number.

Mode	Function
Symbol	Press the appropriate alphanumeric key to select a symbol.

View text or multimedia messages

1. In Idle mode, press <Menu> → Messages → My messages → Inbox.
2. Select a text or multimedia message.

View an email

1. In Idle mode, press <Menu> → Messages → My messages → Email inbox.
2. Select Check new mail.
3. Select an email or a header.
4. If you selected a header, press <Options> → Retrieve to view the body of the email.

Add and find contacts

Learn the basics of using the Phonebook feature.

Add a new contact

1. In Idle mode, enter a phone number and press <Options>.
2. Select Save contact → a memory location (phone or SIM) → New.

3. Select a number type (if necessary).
4. Enter contact information.
5. Press <Save> or the Centre key to add the contact to memory.

Find a contact

1. In Idle mode, press <Menu> → Phonebook → Contact list.
2. Enter the first few letters of the name you want to find.
3. Select the contact's name from the search list.



Once you have found a contact, you can:

- call the contact by pressing [↵]
- edit the contact's information by pressing the Centre key

Use basic camera functions

Learn the basics to capture and view photos and videos.

Capture photos

1. In Idle mode, press <Menu> → Camera to turn on the camera.
2. Aim the lens at the subject and make any adjustments.
3. Press the Centre key to take a photo.
The photo is saved automatically.
4. Press <Back> to take another photo (step 2).

View photos

In Idle mode, press <Menu> → My files → Images → My photos → a photo file.

Capture videos

1. In Idle mode, press <Menu> → Camera to turn on the camera.
2. Press [1] to switch to Recording mode.
3. Aim the lens at the subject and make any adjustments.
4. Press the Centre key to start recording.
5. Press <[]> or the Centre key to stop recording.
The video is saved automatically.
6. Press <[5]> to record another video (step 3).

View videos

In Idle mode, press <Menu> → My files → Videos → My video clips → a video file.

Listen to music

Learn how to listen to music via the music player or FM radio.

Listen to the FM radio

1. Plug the supplied headset into the phone's multifunction jack.
2. In Idle mode, press <Menu> → Applications → FM radio.
3. Press the Centre key to start the radio.
4. Press <Yes> to start automatic tuning.
5. Scroll up or down to select a radio station.
6. To turn the radio off, press the Centre key.

Create a playlist and listen to music files

Start by transferring files to your phone or memory card:

- Download from the wireless web. ▶ Browse the web
- Download from a PC with the optional Samsung PC Studio. ▶ Samsung PC Studio user manual
- Receive via Bluetooth. ▶ p. 37
- Copy to your memory card. ▶ p. 18

After transferring music files to your phone or memory card,

1. In Idle mode, press <Menu> → Applications → Music player.
2. Press <Options> → Add music from → a memory type.
3. Select the files you want to include and press <Add>.

- Press the Centre key to begin playback.
- Control playback using the following keys:

Key	Function
Centre	Pause or resume playback
Volume	Adjust the volume up or down
Navigation	<ul style="list-style-type: none"> Left: Skip backward; Scan backward in a file (press and hold) Right: Skip forward; Scan forward in a file (press and hold) Up: Open the playlist Down: Stop playback

Browse the web

Learn to access and bookmark your favourite web pages.

Browse web pages

- In Idle mode, press <Menu> → Vodafone live! → Vodafone live! to launch your service provider's homepage.
- Navigate web pages using the following keys:

Key	Function
Navigation	Scroll up or down on a web page
Centre	Select an item
<Back>	Return to previous page
<Options>	Access a list of browser options

Bookmark your favourite web pages

1. In Idle mode, press <Menu> → Vodafone live! → Bookmarks → <Options> → Add bookmark.
2. Select an empty location.
3. Enter a page title and a web address (URL).
4. Press <Options> → Save.



using advanced functions

Learn how to perform advanced operations and use additional features of your mobile phone.

Use advanced call functions

Learn about your phone's additional calling capabilities.

View and dial missed calls

Your phone will display calls you have missed on the display. To dial the number of a missed call,

1. Press <View>.
2. Scroll to the missed call you want to dial.
3. Press [↶] to dial.

Call a recently dialed number

1. In Idle mode, press [↶] to display a list of recent numbers.
2. Scroll to the number you want and press [↶] to dial.

Hold a call or retrieve a held call

Press <Hold> to place a call on hold or press <Retrieve> to retrieve a held call.

Dial a second call

If your network supports this function, you can dial another number during a call:

1. Press <Hold> to put the first call on hold.
2. Enter the second number to dial and press [↵].
3. Press <Swap> to switch between the two calls.
4. To end the call on hold, press <Options> → End held call.
5. To end the current call, press [⏏].

Answer a second call

If your network supports this function, you can answer a second incoming call:

1. Press [↵] to answer the second call.
The first call is automatically placed on hold.
2. Press <Swap> to switch between the calls.

Make a multiparty call (conference call)

1. Call the first party you want to add to the multiparty call.
2. While connected to the first party, call the second party.
The first party is automatically placed on hold.
3. When connected to the second party, press <Options> → Join.

- Repeat steps 1 and 2 to add more parties (if necessary).
- To end the multiparty call, press [↵].

Call an international number

- In Idle mode, press and hold [0] to insert the + character.
- Enter the complete number you want to dial (country code, area code, and phone number), and then press [↵] to dial.

Call a contact from the Phonebook

You can call numbers directly from the Phonebook using stored contacts. ► [p.25](#)

- In Idle mode, press <Menu> → Phonebook → Contact list.
- Scroll to the number you want to dial and press [↵] to dial.

Use advanced Phonebook functions

Learn to create namecards, set speed dial numbers, and create groups of contacts.

Create a namecard

- In Idle mode, press <Menu> → Phonebook → My namecard.
- Enter your personal details and press <Options> → Save.



You can send your namecard by attaching it to a message or email or transferring it via the Bluetooth wireless feature.

Set speed dial numbers

- In Idle mode, press <Menu> → Phonebook → Speed dial.
- Scroll to a number you want to set (2-9) and press the Centre key.

3. Select a contact to assign to the number.
The contact is saved to the speed dial number.



You can now call this contact from Idle mode by pressing and holding the assigned speed dial number.

Create a group of contacts

By creating groups of contacts, you can assign ringtones and caller ID photos to each group or send messages and emails to an entire group. Start by creating a group:

1. In Idle mode, press <Menu> → Phonebook → Group → <Options> → Add.
2. Enter a group name and scroll down.
3. To set the caller ID image, press the Centre key → an image category → an image → <Select>.

4. To set a group ringtone, scroll down and press the Centre key → a ringtone category → a ringtone.
5. Press <Save>.

Use advanced messaging functions

Learn to create templates and use templates to create new messages.

Create a text template

1. In Idle mode, press <Menu> → Messages → Templates → Text template.
2. Press the Centre key to open a new template window.
3. Enter your text and press the Centre key to save the template.

Create a multimedia template

1. Create a multimedia message, with a subject and desired attachments, to use as your template. ► p. 23
2. From the message screen, press <Options> → Save in → Templates.
The message is now saved as a multimedia template with a preset name, such as 'Birthday.'

Insert text templates in new messages

1. To start a new message, press <Menu> → Messages → Create new message → a message type.
2. Select the text field, and press <Options> → Insert → Template or Text template → a template.
3. Press the Centre key to insert the template text into your message.

Create a message from a multimedia template

1. In Idle mode, press <Menu> → Messages → Templates → Multimedia message templates.
2. Scroll to the template you want and press <Options> → Edit.
Your template opens as a new multimedia message.

Use advanced music functions

Learn to prepare music files and store radio stations.

Copy music files to a memory card

1. Insert a memory card.
2. In Idle mode, press <Menu> → Settings → Phone settings → PC connections → Mass storage.
3. Press [⏪] to return to Idle mode.

- Using an optional PC data cable, connect the multifunction jack on your phone to a PC. When connected, a pop-up window will appear on the PC.
- Select **Open folder to view files in the pop-up window on the PC**.
- Copy files from the PC to the memory card.

Customise your music player settings

Learn to adjust the playback and sound settings for your music player.

- In Idle mode, press <Menu> → Music player.
- Press <Options> → Settings.

- Adjust the settings to customise your music player.
- Press <Save>.

Store radio stations automatically

- Plug the supplied headset into the phone's multifunction jack.
- In Idle mode, press <Menu> → Applications → FM radio.
- Press the Centre key to start the radio.
- Press <Options> → Self-tuning.
- Press <Yes> to confirm (if necessary). The radio scans and saves available stations automatically.

using tools and applications

Learn how to work with your mobile phone's tools and additional applications.

Use the Bluetooth wireless feature

Learn about your phone's ability to connect to other wireless devices for exchanging data and using hands-free features.

Turn on the Bluetooth wireless feature

1. In Idle mode, press <Menu> → Applications → Bluetooth → Activation → On.
2. To allow other devices to locate your phone, select My phone's visibility → On.

Find and pair with other Bluetooth-enabled devices

1. In Idle mode, press <Menu> → Applications → Bluetooth → My devices → Search new device.
2. Scroll to a device and press <Select>.

3. Enter a PIN for the Bluetooth wireless feature or the other device's Bluetooth PIN, if it has one, and press <OK>.

When the owner of the other device enters the same code or accepts the connection, pairing is complete.

Send data using the Bluetooth wireless feature

1. Select the file or item from one of your phone's applications that you want to send.
2. Press <Options> → Send via → Bluetooth (when sending contact data, specify which data to send).

Receive data using the Bluetooth wireless feature

1. Enter the PIN for the Bluetooth wireless feature and press <OK> (if necessary).
2. Press <Yes> to confirm that you are willing to receive data from the device (if necessary).

Activate and send an SOS message

When you have an emergency, you can send an SOS message asking for help.

1. In Idle mode, press <Menu> → Messages → SOS messages → Sending options.
2. Scroll right to turn on the SOS messaging feature.
3. Scroll down and press the Centre key to open the recipients list.
4. Press the Centre key to open your contact list.

5. Scroll to a contact and press the Centre key.
6. When you are finished selecting contacts, press <Select> to return to the recipients list.
7. Press <Options> → Save to save the recipients.
8. Scroll down and set the number of times to repeat the SOS message.
9. Press <Save> .
10. Press <Yes> to confirm .

To send an SOS message, the phone must be closed and the keys locked. With the phone closed, press the Volume key four times.



Once you send an SOS message, all phone functions will be suspended until you press [⏏].

Activate mobile tracker

When someone inserts a new SIM card in your phone, the mobile tracker feature will automatically send the contact number to two recipients to help you locate and recover your phone. To activate mobile tracker,

1. In Idle mode, press <Menu> → Settings → Security settings → Mobile tracker.
2. Enter your password and press <OK> .



The first time you access mobile tracker, you will be prompted to create and confirm a password.

3. Scroll right to turn on the mobile tracker.
4. Scroll down and press the Centre key to open the recipients list.
5. Press the Centre key to open your contact list.
6. Scroll to a contact and press the Centre key.

- When you are finished selecting contacts, press <Select> to return to the recipients list.
- Press <Options> → Save to save the recipients.
- Scroll down and enter the sender's name.
- Scroll down and then edit the message (if necessary).
- Press <Save> → <Accept>.

Record and play voice messages

Learn to operate your phone's voice recorder.

Record a voice message

- In Idle mode, press <Menu> → Applications → Voice recorder.
- Press the Centre key to start recording.

- Speak your message into the microphone (up to 1 hour).
- When you are finished speaking, press <Save>. Your message is saved automatically.

Play a voice message

- From the voice recorder screen, press <Options> → Go to My voice clips.
- Select a file.
- Control the playback using the following keys:

Key	Function
Centre	Pause or resume playback
Volume	Adjust the volume up or down
Navigation	<ul style="list-style-type: none"> Left: Scan backward in a file Right: Scan forward in a file Down: Stop playback

Edit in ages

Learn to edit in ages and apply fun effects.

Apply effects to in ages

1. In Idle mode, press <Menu> → Applications → Image editor.
2. Press <Options> → New in age → Open or Take photo.
3. Select an in age or take a new photo.
4. Press <Options> → Effects → an effect option.
5. Select a variation of the effect to apply and press <Done>.
6. When done with effects, press <Options> → Save as.
7. Press <Yes> to confirm.
8. Enter a new file name for the in age and press the Centre key.

Adjust an in age

1. In Idle mode, press <Menu> → Applications → Image editor.
2. Press <Options> → New in age → Open or Take photo.
3. Select an in age or take a new photo.
4. Press <Options> → Adjust → an adjustment option (brightness, contrast, or colour).
5. Using the navigation key, adjust the in age as desired and press <Done>.
6. Press <Options> → Save as.
7. Press <Yes> to confirm.
8. Enter a new file name for the in age and press the Centre key.

Transform an image

1. In Idle mode, press <Menu> → Applications → Image editor.
2. Press <Options> → New image → Open or Take photo.
3. Select an image or take a new photo.
4. Press <Options> → Transform → Rotate or Flip.
5. Using the navigation key, rotate or flip the image as desired and press <Done>.
6. Press <Options> → Save as.
7. Press <Yes> to confirm.
8. Enter a new file name for the image and press the Centre key.

Insert a visual feature

1. In Idle mode, press <Menu> → Applications → Image editor.
2. Press <Options> → New image → Open or Take photo.
3. Select an image or take a new photo.
4. Press <Options> → Insert → a visual feature (frame, clip art, or emoticon).
5. Select a visual feature to add and press <Select>.
6. Press <Done>.
7. Press <Options> → Save as.
8. Press <Yes> to confirm.
9. Enter a new file name for the image and press the Centre key.

Use Java-powered games and applications

Learn to use games and applications powered by award-winning Java technology.

Play games

1. In Idle mode, press <Menu> → My files → Games & more.
2. Select a game from the list and follow the onscreen instructions.



Available games may vary, depending on your service provider or country. Game controls and options may vary.

Launch applications

1. In Idle mode, press <Menu> → My files → Games & more → an application.
2. Press <Options> to access a list of various options and settings for your application.

View world clocks

Learn to view the time in another country or city and set world clocks to appear on your display.

View a world clock

1. In Idle mode, press <Menu> → Planner → World clock.
2. Scroll down to a world clock.
3. Scroll left or right to select a time zone.

4. To set daylight saving time, press <Options> → Apply daylight saving time → a time zone → <Save>.
5. Press <Options> → Save.

Add a world clock to your display

In Dual Clock Display mode, you can view clocks with two different time zones on your display.

1. In Idle mode, press <Menu> → Planner → World clock.
2. Scroll to a world clock and press <Options> → Mark as second clock.
3. Press <Options> → Display settings.
4. Scroll left or right to select Dual digital.
5. Press <Save>.

Set and use alarms

Learn to set and control alarms for important events.

Set a new alarm

1. In Idle mode, press <Menu> → Planner → Alarms.
2. Scroll to an empty alarm slot and press the Centre key.
3. Set alarm details.
4. Press <Save>.



The auto power-up feature sets the phone to automatically turn on and sound the alarm at the designated time if the phone is switched off.

Stop an alarm

When the alarm sounds,

- Press any key to stop an alarm without snooze.
- Press <OK> or the Centre key to stop an alarm with snooze or press any key to silence the alarm for the snooze period.

Deactivate an alarm

1. In Idle mode, press <Menu> → Planner → Alarms.
2. Scroll to the alarm you want to deactivate and press the Centre key.
3. Scroll down to Alarm and select Off.
4. Press <Save>.

Use the calculator

1. In Idle mode, press <Menu> → Planner → Calculator.
2. Use the keys that correspond to the calculator display to perform basic mathematical operations.

Convert currencies or measurements

1. In Idle mode, press <Menu> → Planner → Converter → a conversion type.
2. Enter the currencies or measurements and units in the appropriate fields.

Set a countdown timer

1. In Idle mode, press <Menu> → Planner → Timer.
2. Press <Set>.
3. Enter hours or minutes to countdown and press <OK>.
4. Press the Centre key to begin or pause the countdown.
5. When the timer expires, press <OK> to stop the alert.

Use the stopwatch

1. In Idle mode, press <Menu> → Planner → Stopwatch.
2. Press the Centre key to begin and record lap times (up to 4).
3. Press <Stop> to stop the stopwatch.
4. Press <Reset> to clear recorded times.

Create a text memo

1. In Idle mode, press <Menu> → Planner → Memo.
2. Press <Create>.
3. Enter your memo text and press the Centre key.

Manage your calendar

Learn to change the calendar view and create events.

Change the calendar view

1. In Idle mode, press <Menu> → Planner → Calendar.
2. Press <Options> → View by → Day or Week.

Create an event

1. In Idle mode, press <Menu> → Planner → Calendar.
2. Press <Options> → Create → an event type.
3. Enter the details of the event as required.
4. Press <Save> .



overview of menu functions

To access Menu mode, press <Menu> in Idle mode.

1 Call log

- 1 Recent contacts
- 2 Missed calls
- 3 Dialed calls
- 4 Received calls
- 5 Delete all
- 6 Call manager

2 Phonebook

- 1 Contact list
- 2 FDN contacts¹
- 3 Create contact
- 4 Group
- 5 Speed dial
- 6 My name card
- 7 Own number
- 8 Management
- 9 **Service number¹**

3 Applications

- 1 Music player
- 2 Voice recorder
- 3 FM radio
- 4 Image editor
- 5 Bluetooth

3 Applications

- 6 SIM application toolkit

4 Vodafone live!²

- 1 Vodafone live!
- 2 Bookmarks
- 3 Enter URL
- 4 Clear cache
- 5 Profile settings
- 6 Current profile
- 7 Games
- 8 Music
- 9 News
- 10 Pictures
- 11 Sport
- 12 Ringtone

5 Messages

- 1 Create new message
- 2 My messages
- 3 Templates
- 4 Delete all
- 5 Settings
- 6 SOS messages

5 Messages

- 7 Broadcast messages
- 8 Memory status

6 My files

- 1 Images
- 2 Videos
- 3 Music
- 4 Sounds
- 5 Games & more
- 6 Other files
- 7 **Memory card³**
- 8 Memory status

7 Planner

- 1 Alarms
- 2 Calendar
- 3 Memo
- 4 World clock
- 5 Calculator
- 6 Converter
- 7 Timer
- 8 Stopwatch

8 Camera

9 Settings

- 1 Phone settings
- 2 Light settings
- 3 Display settings
- 4 Message settings
- 5 Call settings
- 6 Phonebook settings
- 7 Calendar settings
- 8 Browser settings
- 9 Music player settings
- 10 Network settings
- 11 Security settings
- 12 Setup wizard
- 13 Memory settings
- 14 Reset settings

1. Available only if supported by your SIM card.
2. **Submenus in this menu will vary, depending on your country.**
3. Available only if a memory card is inserted.

troubleshooting

If you are having trouble with your mobile phone, try these troubleshooting procedures before contacting a service professional.

When you turn on your phone, the following messages may appear:

M message	Try this to solve the problem :
Insert SIM	Ensure that the SIM card is installed correctly.
Phone lock	When the phone lock feature is enabled, you must enter the password you set for the phone.
Enter PIN	When using the phone for the first time or when the PIN requirement is enabled, you must enter the PIN supplied with the SIM card. You can disable this feature by using the PIN lock menu.

M message	Try this to solve the problem :
Enter PUK	Your SIM card is blocked, usually as a result of entering your PIN incorrectly several times. You must enter the PUK supplied by your service provider.

Your phone displays "No service," "Network failure," or "Not done."

- When you are in areas with weak signals or poor reception, you may lose reception. Move to another area and try again.
- You cannot access some options without a subscription. Contact your service provider for more details.

You enter a number, but the call is not dialed.

- Ensure that you have pressed the Dial key: [📞].
- Ensure that you have accessed the right cellular network.
- Ensure that you have not set call barring for the phone number.

Another caller cannot reach you.

- Ensure that your phone is turned on.

- Ensure that you have accessed the right cellular network.
- Ensure that you have not set call barring for the phone number.

Another caller cannot hear you speaking.

- Ensure that you are not covering the built-in microphone.
- Ensure that the microphone is close to your mouth.
- If using a headset, ensure that it is properly connected.

The phone beeps and the battery icon flashes.

Your battery is low. Recharge or replace the battery to continue using the phone.

The audio quality of the call is poor.

- Ensure that you are not blocking the phone's internal antenna.

- When you are in areas with weak signals or poor reception, you may lose reception. Move to another area and try again.

You select a contact to call, but the call is not dialled.

- Ensure that the correct number is stored in the contact list.
- Re-enter and save the number, if necessary.

The battery does not charge properly or sometimes the phone turns itself off.

- The battery terminals may be dirty. Wipe both gold-coloured contacts with a clean, soft cloth and try charging the battery again.
- If the battery will no longer charge completely, dispose of the old battery properly and replace it with a new battery.



index

alarms

- creating, 43
- deactivating, 44
- stopping, 44

battery

- charging, 17
- installing, 15
- low battery indicator, 18

Bluetooth

- activating, 36
- receiving data, 37
- sending data, 37

browser

- see web browser

calculator

- see tools, calculator

calendar

- see tools, calendar

calls

- advanced functions, 30
- answering additional calls, 31
- answering, 22
- basic functions, 21
- dialling additional calls, 31
- dialling missed calls, 30
- from the Phonebook, 32
- international numbers, 32
- making, 21

m ultiparty, 31

- placing on hold, 31
- recently dialled, 30
- retrieving held calls, 31
- viewing missed, 30

clock

- see world clock

conference calls

- see calls, m ultiparty

contacts

- adding, 25
- creating groups, 33
- finding, 25

[converter](#)

see tools, converter

[countdown timer](#)

see tools, countdown timer

[FM radio](#)

listening to, 27

storing stations, 35

[headset](#) 22[images](#)

adjusting, 40

applying effects, 40

inserting visual features, 41

transforming, 41

[internet](#)

see web browser

[Java](#)

accessing applications, 42

launching games, 42

[key tones](#) 20[lock](#)

see phone lock

[memo](#)

see text or voice memo

[memory card](#) 18[messages](#)

viewing email, 25

viewing multimedia, 24

viewing text, 24

[mobile tracker](#) 38[music player](#)

customizing, 35

listening to music, 27

[namecards](#) 32[offline profile](#) 19[phone lock](#) 21[photos](#)

capturing, 26

viewing, 26

[radio](#)

see FM radio

[shortcut keys](#)

see shortcuts

[shortcuts](#) 21

SIM card 15

skin colour 21

SO S m essage 37

stopw atch

see tools, stopw atch

tem plates

inserting, 34

m ultim edia, 34

text, 33

text

creating m em os, 45

entering, 24

tim er

see tools, tim er

tools

alam , 43

calculator, 44

calendar, 46

converter, 44

countdown tim er, 45

stopw atch, 45

videos

capturing, 26

view ing, 26

voice m em os

playing, 39

recording, 39

volum e

call volum e, 22

key tone volum e, 20

w allpaper 21

w eb brow ser

adding bookm arks, 29

launching hom epage, 28

w orld clock

setting dual display, 43

view ing, 42

Declaration of Conformity (R&TTE)

We, **Samsung Electronics**
declare under our sole responsibility that the product

GSM Mobile Phone : SGH-J700V

to which this declaration relates, is in conformity with the following standards and/or other normative documents.

SAFETY

EMC

SAR

RADIO

We hereby declare that [all essential radio test suites have been carried out and that] the above named product is in conformity to all the essential requirements of Directive 1999/5/EC.

The conformity assessment procedure referred to in Article 10 and detailed in Annex[] of Directive 1999/5/EC has been followed with the involvement of the following Notified Body(ies):

BABT, Balfour House, Churchfield Road,
Walton-on-Thames, Surrey, KT12 2TD, UK*
Identification mark: 0168



The technical documentation kept at :

Samsung Electronics QA Lab.

which will be made available upon request.
(Representative in the EU)

Samsung Electronics Euro QA Lab.
Blackbushe Business Park, Saxony Way,
Yateley, Hampshire, GU46 6GG, UK*

2007. .

Yong-Sang Park / S. Manager

(place and date of issue)

(name and signature of authorised person)

* It is not the address of Samsung Service Centre. For the address or the phone number of Samsung Service Centre, see the warranty card or contact the retailer where you purchased your phone.