

LAVAMAT L 12510 VI LAVAMAT L 14510 VI

Washing Machine

Instruction Booklet

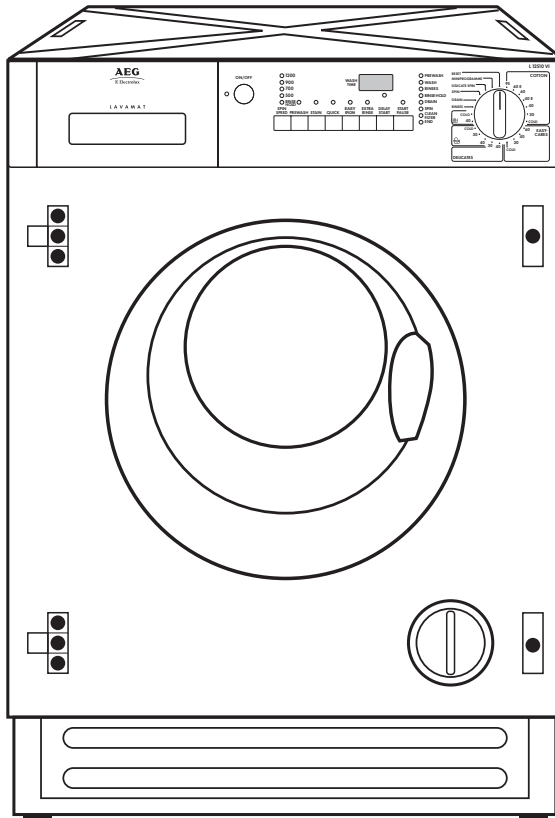

AEG

PERFEKT IN FORM UND FUNKTION

Electrolux

Dear customer,

Please read these operating instructions carefully and pay particular attention to the safety notes indicated in the first pages. We recommend that you keep this instruction booklet for future reference and pass it on to any future owners.



The warning triangle and/or the key words (Warning!, Caution!) emphasize information that is particularly important for your safety or correct functioning of the appliance.



This symbol guides you, step by step, in the operation of the appliance.



The information marked with this symbol provides additional instructions and practical tips on the use of the appliance.



Tips and information about economical and ecological use of the machine are marked with the clover symbol.

If you require assistance or advice on your appliance, please contact our customer care department by letter or telephone:

Customer Care Department
AEG/ELECTROLUX Major Appliances
Addington Way
Luton
Bedfordshire LU4 9QQ
Tel: 08705 350 350*
* calls to this number may be recorded for training purposes.

Important

Your machine is fitted with a balance control device, which ensures the machine is stable during the spin.

If the wash load appears not to have been spun sufficiently at the end of the wash cycle, because it is not evenly distributed in the drum, the balance control device may have operated. It will therefore be necessary to redistribute the wash load manually and select a spin programme. For more detailed information see the section headed "Something Not Working".

Printed on recycled paper.
People who think ecologically, act accordingly....

Contents

Safety instructions	6
Disposal	8
Tips for environmental protection	9
Main features of your washing machine	10
Description of the appliance	11
Control panel	12
Programme selector dial	12
ON/OFF button	13
Mains-on light	13
START/PAUSE button	13
DELAY START button	13
Programme Option buttons	14
SPIN SPEED	14
RINSE HOLD	14
PREWASH	15
STAIN	15
QUICK	15
EASY IRON	15
EXTRA RINSE	15
Display	16
Programme progress display	16
Cancelling/Altering a programme	16-17
Opening the door after the programme has started	17
Detergent dispenser drawer	18
Before the first wash	18
Preparing the wash cycle	19
Sorting out and preparing the laundry	19
Weight of laundry	20
Types of fabric and care labels	20
Detergents and additives	22
Which detergent?.....	22
WHITES	22
NON BIOLOGICAL	22
COLOURED	22
DELICATE ITEMS	22
LAUNDRY BLEACH	22
STAIN REMOVER	22

And in which form?.....	23
TRADITIONAL POWDERS.....	23
TRADITIONAL LIQUIDS.....	23
COMPACT POWDERS AND LIQUIDS.....	23
FABRIC CONDITIONERS.....	23
How to wash	24
Load the laundry	24
Add detergent and additive.....	24
Switching the machine on.....	24
Selection of the desired wash programme.....	25
Selection of the SPIN SPEED or RINSE HOLD option.....	25
Selection of the STAIN, PREWASH or QUICK WASH option.....	25
Selection of the EXTRA RINSE option	25
Selection of the DELAY START option	26
Starting the programme.....	26
At the end of the programme.....	27
Programme charts	28-29
Cleaning and maintenance	30
After each wash	30
Periodical cleaning	30
Exterior.....	30
Detergent dispenser drawer.....	30
Door seal	31
Drain filter	31
Water inlet filter.....	32
Emergency emptying out.....	32
Frost precautions	32
Something not working?	33-36
Troubleshooting	33
Unsatisfactory washing results	37
Technical data	38
Service & Spare Parts	39
Guarantee Conditions	41
Instructions for installation and electrical connection	43
Safety instructions for the installer.....	43
Dimensions of the appliance	44
Front view and side view	44
Rear view	44

Installation	45-50
Unpacking	45
Positioning	46
Levelling	46
Water inlet (cold water connection only)	47
Water drainage	47-48
In the interest of the environment	49
Electrical connections	49-50
Permanent connection	50
Building-in	51-54



Safety instructions

Your safety is of paramount importance, please ensure you read this instruction book before installing or using this appliance.

General safety

- Repairs to the machine must be carried out only by qualified personnel. Repairs carried out by inexperienced persons could cause injury or serious malfunctioning. Contact your local AEG/ELECTROLUX Service Force Centre.
- Never start the machine if the mains cable is damaged or the control panel or worktop are damaged allowing inner components to be accessible.
- Unplug the appliance before carrying out any cleaning or maintenance operations.
- Never pull the mains cable to remove the plug from the socket; always take hold of the plug itself.
- During high temperature wash programmes cycle, the door glass may get hot.
- Let the water cool down before carrying out emergency emptying or before opening the door in an emergency.

Installation

- Follow the installation instructions **carefully**.
- Carry out a first wash without laundry (COTTONS 95, with half the amount of detergent) in order to remove any manufacturing residue from the tub and the drum.

Child safety

- This appliance is designed to be operated by adults. Children should not be allowed to tamper with the controls or play with the appliance.
- Pets and children have been known to climb into washing machines. Please check the drum before use.
- Keep all packaging well away from children.
- Keep all detergents in a safe place out of children's reach.
- When disposing of the appliance, cut off the mains cable, and destroy the plug. Disable the door catch to prevent young children being trapped inside.

During use

- Always unplug the appliance and turn off the water tap after use.
- This appliance is designed for domestic use only. If the machine is used for any other purposes or is not used correctly, the manufacturer accepts no responsibility for any possible damage that might occur.
- For safety reasons, the appliance must not be modified.
- Use only detergents suitable for washing machines and follow the manufacturer's instructions.
- Garments which have been in contact with flammable solvents should not be machine washed.
- Dyes and bleaching agents may only be used if specifically permitted by the manufacturer of these products. We cannot be held liable for any damage.



Disposal

Packaging materials

The materials marked with the symbol  are recyclable.

>PE<=polyethylene

>PS<=polystyrene

>PP<=polypropylene

This means that they can be recycled by disposing of them properly in appropriate collection containers.

Machine

Use authorised disposal sites for your old appliance. Help to keep your country tidy!

The symbol  on the product or on its packaging indicates that this product may not be treated as household waste. Instead it shall be handed over to the applicable collection point for the recycling of electrical and electronic equipment. By ensuring this product is disposed of correctly, you will help prevent potential negative consequences for the environment and human health, which could otherwise be caused by inappropriate waste handling of this product. For more detailed information about recycling of this product, please contact your local city office, your household waste disposal service or the shop where you purchased the product.



Tips for environmental protection

To save water, energy and to help protect the environment, we recommend that you follow these tips:

- Normally soiled laundry may be washed without prewashing in order to save detergent, water and time (the environment is protected too!).
- Use the energy saving programme when washing normally soiled garments.
- The machine works more economically if it is fully loaded.
- When small loads are washed, use only half to two thirds of the recommended amount of detergent.
- With adequate pre-treatment, stains and limited soiling can be removed; the laundry can then be washed at a lower temperature.

Main features of your washing machine

- Programme and temperature setting using the programme selector.
- **Stain option** for effectively treating stained washing.
- **Energy saving programme** for normally soiled cotton items.
- **Speed for the final spin** can be reduced to 900, 700 or 500 rpm.
- **RINSE HOLD**: the laundry is left immersed in the final rinse water to prevent creasing.
- **DELAY START (delayed start)**: programme start can be delayed by 30 minutes to 23 hours (e.g. to times with a more economical power rate).
- **Programme progress display** showing the programme steps selected and the programme phase which is running.
- Because of its gentle washing action, the **special wool cycle** washes your garments with extreme care.
- **3-compartment drawer** for detergent and fabric softener.
- **Unbalance detection device**: to prevent vibration during spinning.

Description of the appliance

Front view

Detergent drawer

Control panel

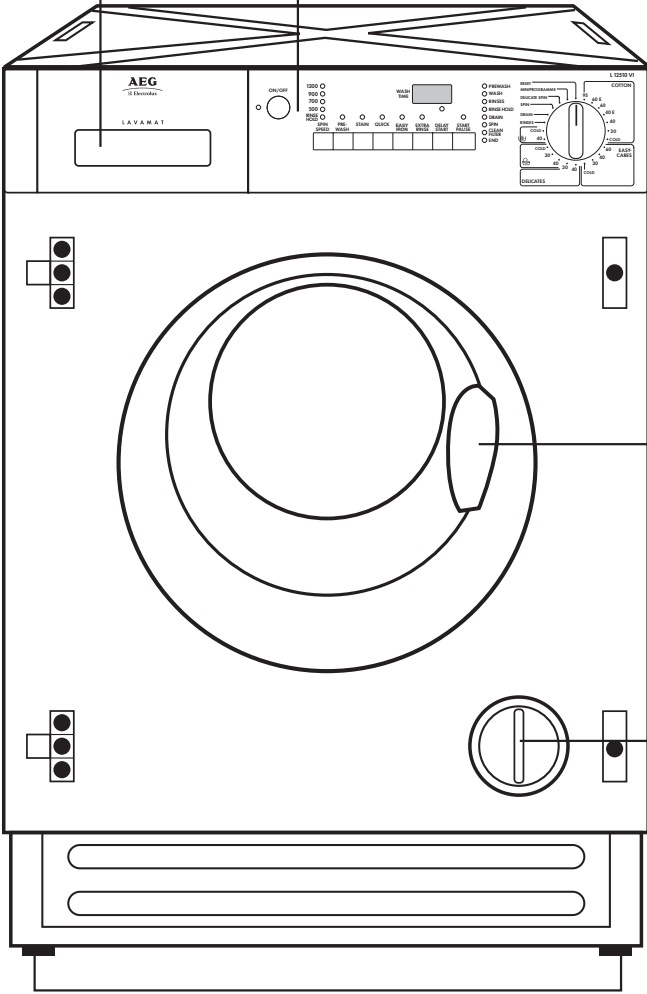

Door

Drain filter

Adjustable feet

Control panel

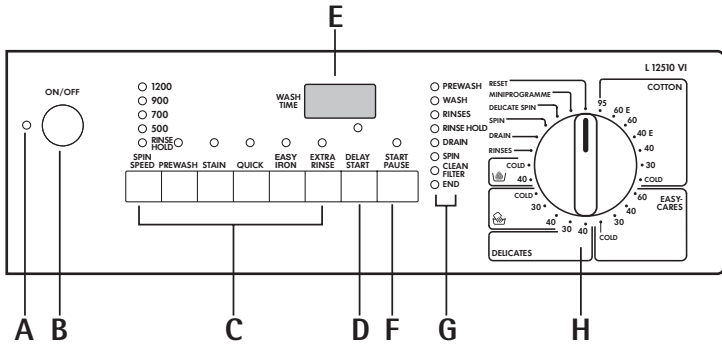

- A = Mains-on light
- B = ON/OFF button
- C = Option buttons
- D = Delay start button
- E = Display
- F = START/PAUSE button
- G = Programme progress display
- H = Programme selector dial

Programme selector dial

The programme selector determines the type of washing cycle (e.g. water level, drum movement, number of rinses, spin speed) and the washing temperature to be selected according to the type of laundry.

The selector is divided into 6 sections:

- Cotton
- Easy-cares (Synthetics)
- Delicates
- Hand washing
- Woollens
- Special programmes

The selector dial can be turned either clockwise or anticlockwise.

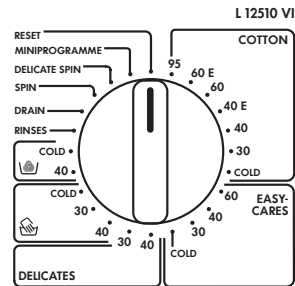



Positions **60E-40E** correspond to the ENERGY SAVING programmes for normally soiled cotton laundry, extended washing time. The washing temperature will decrease (cannot be combined with QUICK).

Position COLD = cold wash.

ON/OFF button

Press this button to switch the machine on. Press it again to switch the machine off.

Mains-on light

This light comes on when the ON/OFF button is pressed, and goes out when it is pressed again.

START/PAUSE button

This button has two functions:

a) Start

After having selected the required programme, press this button to start the machine. The relevant pilot light stops flashing and remains static. If you have selected the DELAY START option, the machine starts its hourly countdown.

b) Pause

To interrupt a programme which is running, press the START/PAUSE button: the information on the display remains lit and the START/PAUSE pilot light starts to flash.

To restart the programme from the point at which it was interrupted, press the START/PAUSE button again.

DELAY START button

The wash programme can be delayed from 30, 60, 90 minutes and then 1 hour by 1 hour up to a maximum of 23 hours.

The button must be pressed after selecting the programme and before pressing the START/PAUSE button.

The figures indicating the delay appear for about 3 seconds in the display. The duration of the selected wash programme is then displayed. After depressing the START/PAUSE button, the machine starts its hourly countdown.

To annul the preset delay, press the START/PAUSE button, then press the DELAY START button until the symbol \emptyset is displayed.

Then press the START/PAUSE button again to restart the programme.

Programme Option buttons

Depending on the programme, different functions can be combined. These must be selected after choosing the desired programme and before depressing the START/PAUSE button.

When these buttons are pressed, the corresponding pilot lights come on. When they are pressed again, the pilot lights go out.

When an incorrect option is selected, the button light flashes for 2 seconds and in the display the **Err** message appears.

SPIN SPEED

Press this button to reduce the maximum speed of the final speed proposed by the machine for the selected programme or to select RINSE HOLD option. The maximum spin speed for cotton is 1400 rpm (for L14510VI), 1200 rpm (for L12510VI), for easy cares, wool 900 rpm and for delicates and Miniprogramme 700 rpm.

RINSE HOLD

By selecting this option, the last rinse water is not emptied out, to prevent the fabrics from creasing. When the programme has finished, the pilot light END and RINSE HOLD on the programme progress display are on, the pilot light START/PAUSE are off, on the display appears a blinking zero and the door will be locked to indicate that the water must be emptied out.

To empty out the water:

- select the DRAIN programme to empty out the water without spinning.
- select the SPIN or DELICATE SPIN programmes for draining and spinning.
- select the SPIN SPEED and depress the START/PAUSE button;

Warning! The programme selector dial must be turned first to **RESET** and then to the DRAIN or SPIN programmes.

PREWASH

The machine performs a prewash cycle at 30°C max. The prewash cycle ends with a short spin in programmes for Cotton and Easy-cares, and with emptying of the water only for Delicates.

This option is **not** available with the Wool and Handwash programmes, Miniprogramme and **cannot** be used with STAIN.

For use when washing heavily soiled laundry.

STAIN

To treat heavily soiled washing or stained washing with stain remover (extended main wash with time optimised stain action phase, **not** selectable for Wool and Handwash or programmes with temperatures lower than 40°C). This function **cannot** be used with PREWASH.

QUICK

By pressing this button the washing time is reduced. For use when washing lightly soiled laundry.

This option is **not available** with the Wool and Handwash, Miniprogramme and Economy programmes.

EASY IRON

Selecting this button the laundry is gently washed and spun to avoid any creasing. In this way ironing is easier. Furthermore the machine will perform 6 rinses instead of 3 for cotton and 4 rinses instead of 3 for synthetics. This function can be used **only** for cotton and Easy-Cares (synthetic) fabrics.

If this option is selected for cotton programmes, the spin speed automatically will reduce to 900 rpm.

If this option is selected for synthetic programmes with a temperature of 60°C, the machine will perform a washing cycle at max 40°C.

EXTRA RINSE

Selecting this button the machine will add 2 rinses for cottons and 1 rinse for synthetics and delicates.

This option **can be selected with all** programmes, except the Wool and handwash programmes and Miniprogramme.

This option is recommended for people who are allergic to detergents, and in areas where the water is very soft..

Display

The display shows the following information:

- **Duration of the selected programme (in hours and minutes)**, calculated automatically on the basis of the maximum recommended load for each type of fabric.
- When the programme has finished, a **blinking lit zero** is displayed.
- **Delayed start**, (23 hours max.) programmed using the special button. The countdown is updated every hour and by 30 minutes the last 2 hours.
- **Alarm code** indicating a fault in the machine operation (see page 33).

Programme progress display

By selecting the wash programme, the pilot lights corresponding to the various phases making up the programme come on.

After the machine has started, only the running phase pilot light stays on. When the programme has finished, the END pilot light comes on.

- PREWASH
- WASH
- RINSES
- RINSE HOLD
- DRAIN
- SPIN
- CLEAN FILTER
- END

Cancelling a programme

To cancel a programme which is running, turn the programme selector dial to the **RESET** position.

Warning! After a programme which ends with water in the drum (RINSE HOLD option), turn the selector dial first to **RESET** and then to the DRAIN, SPIN or DELICATE SPIN programme.

Altering an option/programme which is running

To alter an option, first set the machine to PAUSE by pressing the START/PAUSE button.

Any option can be modified before the machine starts it. After selecting the new option press the START/PAUSE button again to restart the selected programme.

To modify the selected programme turn the programme selector dial to **RESET** and then choose a new programme.

After pressing the START/PAUSE button again, the machine restarts with the newly selected programme and the water **is not** emptied out.

Opening the door after the programme has started

You can open the door, after having set the machine to PAUSE, provided the following conditions exist:

- the machine is not in the heating phase beyond 55°C;
- the level of the water is not high;
- the drum is not turning.

If these requirements are met, when you pause the machine the door can be opened.

Should it not be possible to open the door, and should it be absolutely necessary to do so, switch the machine off by pressing the ON/OFF button.



After approximately 3 minutes, you can open the door.

Pay attention to the level and temperature of the water in the machine!

When you close the door and press the ON/OFF and START/PAUSE buttons again, the washing machine will resume the programme from the point where it had been interrupted.

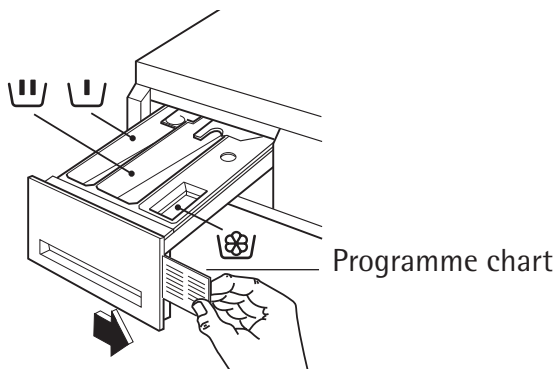
Detergent dispenser drawer



-  Compartment for prewash detergent and stain remover. The prewash detergent is added at the beginning of the wash programme. The stain remover is added during the STAIN-Action phase in the main wash.
-  Compartment for powder or liquid detergent used for main wash. It is emptied at the beginning of the wash cycle.
-  Compartment for liquid additives (fabric softener, starch). It is emptied at the last rinse.

The quantity of additives must not exceed the "MAX" mark in the drawer.

Before the first wash

Before your first wash, we recommend that you run a cotton cycle at 95°C, **without any laundry in the machine**, to remove any manufacturing residue from the drum and tub.

Pour 1/2 a measure of detergent into the dispenser drawer and start the machine.

Preparing the wash cycle

Sorting out and preparing the laundry

- Sort out the laundry according to type of fabrics and care labels (see "Types of fabric and care labels").
- Empty pockets.
- Remove any metal parts (safety pins, clips, etc.).
- To prevent the laundry from getting damaged and forming bundles, it is advisable to close zips, button up pillowcases and quilt covers and tie up loose straps such as those of aprons.
- Turn double faced items inside out (sleeping bags, anoraks, etc.)
- Turn coloured knitted fabrics, woollens and fabrics with trim inside out.
- Wash small and delicate items (baby socks, tights) inside a laundry net or in a pillow case closed with a zip, or in larger socks.
- Treat curtains with special care. Remove all metal or plastic hooks or put them in a net or a bag. We decline any responsibility in case of damage.
- Whites and coloureds must be washed separately: white items can lose their whiteness.
- New coloured fabrics often have excess dyes; it is advisable to wash them separately for the first time.
- Wash small and large items together; this improves the washing result and the laundry is better distributed during spinning.
- Shake out garments before putting them into the machine.
- Insert each garment separately.

Weight of laundry

Sort of laundry	Approximate dry weights
Bathrobes	1200 g
Work shirts	300-600 g
Quilt covers	700 g
Sheets	500 g
Blouses	100 g
Hand towels	200 g
Tea towels	100 g
Shirts	200 g
Pillowcases	200 g
Night-gowns/Pyjamas	200-250 g
Tablecloths	200-300 g
Underwear	250 g

Types of fabric and care labels

The labels on garments help you to select the most suitable wash programme. The laundry should be sorted out according to the type of fabric and the instructions indicated on care labels.

Temperatures indicated on labels are always maximum temperatures.

Cotton

Linen and cottons marked with this symbol can be washed at high temperatures.

Cotton

Linen and cottons marked with this symbol are colourfast and can be washed at 60°C.

Cotton

Garments marked with these symbols have delicate colours, therefore the washing temperature must not exceed these values.

Synthetics (Easy-cares)

Mixed and synthetic fabrics marked with these symbols require a gentle wash programme and they must therefore be washed using the specific programme.

Delicates  

Microfibrés, easy-cares or curtains marked with these symbols require a very gentle treatment.

The DELICATES programme is suitable for this type of fabric.

Woollens and particularly delicate items   

Fabrics such as wool, wool mix or silk marked with this symbol are particularly sensitive to machine washing.

The WOOLLENS programme is suitable for this type of fabric.

Fabrics marked with the  symbol (wool) can be machine washed only if the label indicates "does not felt" or "machine washable".

If the label has the symbol  (do not wash), the garments must not be machine washed!

Detergents and additives

Which detergent?....

To ensure you obtain the best wash results from your appliance, it is important to use the right detergent in your everyday wash, and only detergents recommended for use in automatic machines.

To maintain the appearance of your clothes and household textiles and to make them last longer you should use different types of detergent for different washes, whether for whites, colours or delicates.

WHITES

We recommend the Ariel product range which is biological and designed to provide excellent cleaning and stain removal even at low temperatures.



NON BIOLOGICAL

If you prefer to use a non biological detergent, which does not contain enzymes we recommend Fairy. Fairy provides good cleaning and stain removal.



COLOURED

For coloured items you should use a detergent which is designed to clean while maintaining the original colour. Ariel Color does not contain bleach and therefore helps to preserve colours.



DELICATE ITEMS

When washing delicates such as woollens, you should use a product which is specially designed to care for fine fabrics. Dreft Automatic is suitable for woollens and other delicates.



LAUNDRY BLEACH

For additional stain removal you may wish to use a product such as Ace Gentle Bleach which is used in addition to your chosen detergent. Ace is suitable for all washable fabrics including silks, woollens and coloureds.



STAIN REMOVER

For heavily soiled garments to be washed with STAIN-Action, you should use stain removers such as VANISH In-Wash, Ecover Stain Salt and GloWhite Booster.



And in which form?

Not only are there different types of detergent, but they are also available in different forms. Whether you chose a powder or liquid in traditional or compact form is your own personal choice.

TRADITIONAL POWDERS

Pour the powder directly into the dispenser drawer. Do not sprinkle powder onto clothes in the machine drum.

TRADITIONAL LIQUIDS

Liquid can be placed in the main wash compartment of the detergent drawer marked with the symbol , start the machine immediately upon placing the detergent in the dispenser drawer.

Alternatively the detergent is measured into the specially designed dosing device* which should be placed on top of the laundry, and at the back of the machine drum.

COMPACT POWDERS AND LIQUIDS

Compact detergents (or concentrates as they are also known) are available in liquid or powder form, and generally require a smaller dosage. Follow the manufacturer's instructions to ensure the most economical usage. Pour the detergent directly into the dispenser drawer, or alternatively measure the detergent into the specially designed dosing device* which should be placed on top of the laundry, and at the back of the machine drum.

* If you use a dosing device in a washer dryer, please ensure the dosing device/ball is removed before carrying out a drying programme.

FABRIC CONDITIONERS



These are ideal for improving "softness", and also reduce static cling on easy-cares and make ironing easier. They are available in two types:

- For example Lenor liquid fabric softener, for use in the **washing machine/washer dryer**. The liquid fabric softener should be poured into the compartment marked with the symbol . Follow the manufacturer's dosage instructions and never exceed the MAX level.
- Bounce conditioning sheets for use in a **tumble dryer**. We recommend the conditioning sheets are pinned (using a safety pin) to an article of laundry and placed in the tumble dryer.





i How to wash

Load the laundry

-  Open the door.
-  Place the laundry in the drum, one item at a time. Distribute laundry as evenly as possible. Close the door.

Add detergent and additive

-  Pull the drawer out till it stops.
-  Pour the main wash detergent into compartment .

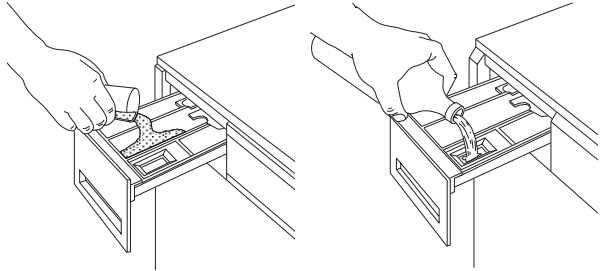



If you wish to perform a Prewash, or a STAIN-Action

programme, pour detergent or stain remover into compartment .

Important!

Do not use normal detergent for the STAIN-Action programme, always use a STAIN remover such as VANISH.

-  Pour the fabric softener into compartment  without exceeding the "MAX" mark.
-  Close the drawer, pushing it fully in.

Switching the machine on

-  To switch the machine on, press the ON/OFF button: if the programme selector dial is on the RESET position, three flashing dashes will be displayed. If the programme selector dial is left on a wash programme position, at the end of the previous washing cycle, the display will show a flashing zero.

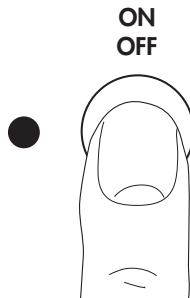

Selection of the desired wash programme

 Turn the programme selector dial to the desired position: the lights corresponding to the different phases making up the selected programme light up.

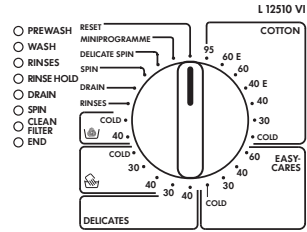

Selection of the spin speed or RINSE HOLD option



 It is possible to select a lower spin speed by means of the relevant button; the light corresponding to the selected speed comes on.

When selecting the RINSE HOLD option, the laundry is left immersed in the final rinse water.

- 1200
- 900
- 700
- 500
- RINSE HOLD



i If the spin speed is not reduced, the final spin speed will be as follows:

- cottons, linens 1400 r.p.m. (L14510VI)
- cottons, linens 1200 r.p.m. (L12510VI)
- easy cares 900 r.p.m.
- delicates or Miniprogramme 700 r.p.m.
- wool  / hand washing  900 r.p.m.

Selection of the desired option,

depending on the degree of soil of the laundry and

on the type of fabric.

The corresponding light comes on.

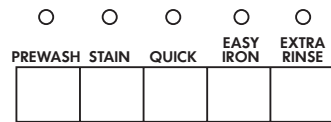

Selection of the DELAY START option

 To delay starting of a programme, press the DELAY START button **before starting the machine**. The figures corresponding to the selected delay will be displayed for about 3 seconds, after which the duration of the selected programme will appear on the display.



DELAY START



When the START/PAUSE button is pressed, the selected delay will again appear on the display and the machine starts its countdown.

Starting the programme

1. Check that the water tap is open.
2. Press START/PAUSE to start the programme.

If the Delay Start option has been selected the programme will start at the end of the countdown.

At the start of the programme, if the "END" light blinks for few seconds and on the display appears E40, that indicates that the door is open. Close the door and press the START/PAUSE button again.

If the delay start option has been selected, the machine starts its countdown, in hours, which will appear on the display. During this period it is possible to load other laundry or cancel the delay time.

- **Load other laundry:** press the START/PAUSE button. Open the door. Load the laundry. Close the door and press the START/PAUSE button again.
- **Cancel the delay time:** press the START/PAUSE button. Press the DELAY START button until on the display appears \square , if you wish to cancel it. Press the START/ PAUSE button again to let the programme restart.

Programme progress display

By selecting the wash programme, the pilot lights corresponding to the various phases making up the programme come on. After the machine has started, only the running phase pilot light stays on.

- PREWASH
- WASH
- RINSES
- RINSE HOLD
- DRAIN
- SPIN
- CLEAN FILTER
- END

Display

The time to the end of the programme decreases minute by minute and appears on the display.

At the end of the programme

The machine stops automatically. A blinking zero appears on the display. The END light comes on in the programme progress display, the START/PAUSE light is off.

 Turn the selector dial to **RESET**.

 If the RINSE HOLD option has been selected the END and the RINSE HOLD lights remain lit, the door is blocked, to indicate that the water must be emptied out before opening the door either

To empty out water:

- select the DRAIN programme to empty out the water without spinning.
- select the SPIN or DELICATE SPIN programmes for spinning.
- select the SPIN SPEED and depress the START/PAUSE button;

Warning! The programme selector dial must be turned first to **RESET** and then to the DRAIN or SPIN programmes.

At the end of the programme the selector dial must be turned to position **RESET** and the machine must be switched off by pressing the ON/OFF button.

 Remove the laundry from the drum.

 Check that the drum is empty so as to avoid any forgotten items being damaged in a subsequent wash (e.g. shrinking) or their colour running into a load of whites.

 Close the water tap.

 Leave the door open to prevent the formation of mildew and unpleasant smells.

Programme chart

Wash programmes

Wash programme	Temp.	Fabrics	Additional functions	Max. load	Consumption*		
					Energy kWh	Water lt.	Duration min.
White Cottons	95°-60°	Cotton and linen, for example normally soiled work garments, sheets, household linen, underwear, towels.	SPIN SPEED RINSE HOLD PREWASH STAIN/QUICK EASY IRON EXTRARINSE	5 kg	1.90	52	140
60E Cotton ECONOMY (Whites)	60°	Cotton and linen, for example normally to lightly soiled sheets and household linen.	SPIN SPEED RINSE HOLD PREWASH STAIN EASY IRON EXTRA RINSE	5 kg	0.85	49	134
Coloured cottons	60° 40°-30° COLD	Coloured cotton or linen fabric, shirts, underwear, towels.	SPIN SPEED RINSE HOLD PREWASH QUICK/STAIN** EASY IRON EXTRA RINSE	5 kg	1.2	49	119
40E Cotton ECONOMY (Coloureds)	40°-30° COLD	Coloured cotton or linen fabric lightly soiled for example shirts, underwear, blouses.	SPIN SPEED RINSE HOLD PREWASH STAIN** EASY IRON EXTRA RINSE	5 kg	0.9	49	139
Easy cares	60°- 40°-30° COLD	Synthetic fabrics, underwear, coloured garments, non-shrink shirts, blouses.	SPIN SPEED RINSE HOLD PREWASH STAIN**/QUICK EASY IRON EXTRA RINSE	2 kg	0.85	41	87
Delicates	40°-30°	Delicate fabrics, for example curtains.	SPIN SPEED RINSE HOLD PREWASH STAIN**/QUICK EXTRA RINSE	2 kg	0.55	58	58
Wool/Hand wash 	40°-30° COLD	Wool, wool mixtures, silk and handwash.	SPIN SPEED RINSE HOLD	1 kg	0.4	58	57

In compliance with EC directive 92/75, the consumption figures indicated on the energy label refer to the "60E" wash programme for cotton.

* The consumption data shown on this chart is to be used as a guide only, as it may vary depending on the quantity and type of laundry, on the inlet water temperature and on the ambient temperature. It refers to the highest temperature for each wash programme.

** Cannot be used with temperatures below 40°C.

Programme chart

Special programmes

Programme	Description	Programme phases	Additional functions	Max. load	Consumption*		
					Energy kWh	Water lt.	Duration min.
Rinses	This programme can be used for rinsing hand washed cotton garments.	3 rinses with liquid additive. Long spin.	SPIN SPEED RINSE HOLD EASY IRON EXTRA RINSE	5 kg	0.1	40	45
Drain	For emptying out the last rinse water in programmes with the Rinse Hold option  .	The water is emptied out.		/	/	/	2
Spin	Separate spin for cotton.	Drain and long spin at max. speed.	SPIN SPEED	5 kg	/	/	10
Delicate Spin	Separate spin for Easy Cares, Delicates, Wool and Handwash.	Drain and short spin.	SPIN SPEED	5 kg	/	/	6
Miniprogramme	Lightly soiled fabrics except Wool and Handwash	Wash at 30°C 2 rinses Short spin (max. 700 rpm).	SPIN SPEED RINSE HOLD	2.5 kg	0.3	40	30
Reset		For cancelling the programme which is running.					

* The consumption data shown on this chart is to be used as a guide only, as it may vary depending on the quantity and type of laundry, on the inlet water temperature and on the ambient temperature. It refers to the highest temperature for each wash programme.

Cleaning and maintenance

After each wash

- ☞ At the end of the wash programme, pull the dispenser drawer out a little to let it dry.
- ☞ Leave the door ajar to allow air to circulate.

If the machine is not used for a prolonged period:

- ☞ Close the water tap and unplug the appliance.

Periodical cleaning

Maintenance Wash

With the use of low temperature washes it is possible to get a build up of residues inside the drum.

We recommend that a maintenance wash be performed on a regular basis.

To run a maintenance wash:

- ☞ The drum should be empty of laundry.
- ☞ Select the hottest cotton wash programme.
- ☞ Use a normal measure of detergent, must be a powder (such as Ariel Futur).

Exterior

- ☞ Clean the outside of the cabinet with soap and water only. Rinse with clean water and dry.

Important: do not use methylated spirits, solvents or similar products to clean the cabinet.



Detergent dispenser drawer

After a while, detergents and fabric softeners leave deposits in the drawer.

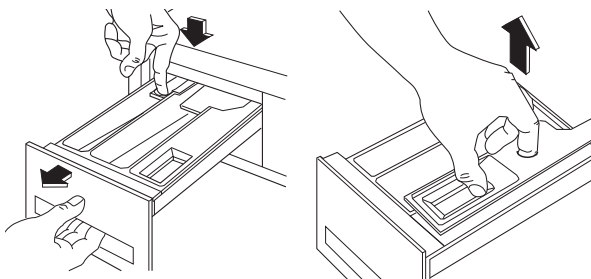
- ☞ Clean the drawer, from time to time, by rinsing it under a running tap.



To remove the drawer from the machine, press the button in the rear left-hand corner.

-  To facilitate cleaning, the top part of the additive compartment can be removed.
-  Detergent can also accumulate inside the drawer recess: clean it with an old toothbrush.
-  Refit the drawer after cleaning.

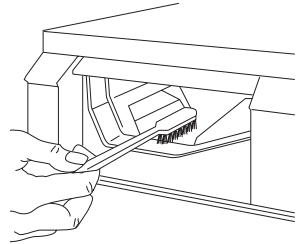

Door seal

Regularly check to see, if there are deposits or foreign objects in the rubber seal behind the door and remove them.

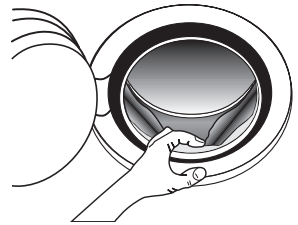



Drain filter

The drain filter collects threads and small objects inadvertently left in the laundry. Check regularly that the filter is clean.

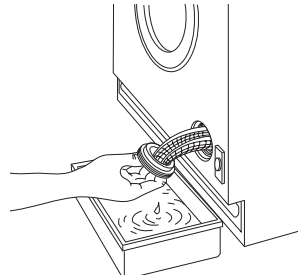
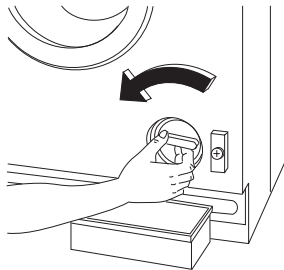
-  Place a container under the filter and unscrew it; some water will come out of the filter.





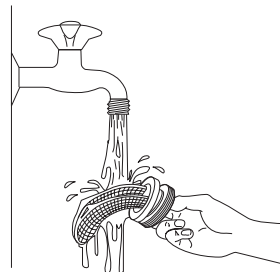

-  Pull out the filter.
-  Clean the filter under a running tap, then refit it, screwing it fully in.



Water inlet filter

If you notice that the machine is taking longer to fill, check that the filter in the water inlet hose is not blocked.

-  Turn off the water tap.
-  Unscrew the hose from the tap. To do this, depress the small yellow button on the hose.
-  Clean the filter with a stiff brush.
-  Screw the hose back onto the tap.

Emergency emptying out

If the water is not discharged (pump is blocked, filter or drain hose are clogged), proceed as follows to empty out the machine:

- pull out the plug from the power socket;
- close the water tap;
- if necessary, wait until the water has cooled;
- place a bowl on the floor;
- put the drain hose end into the bowl and let the water out.

Should it not be possible to have access to the drain hose because, for example the appliance is built in the kitchen furniture, slightly loosen the drain filter after placing a bowl on the floor to let the water come out slowly.

At the end screw the filter again.

Frost precautions

If the machine is installed in a place where the temperature could drop below 0°C, proceed as follows:

- Close the water tap and unscrew the water inlet hose from the tap.
- Place the end of the drain hose and the inlet hose in a bowl placed on the floor.
- Select the "DRAIN" programme and run it until the machine stops.
- Turn the programme selector dial to RESET.
- Press the ON/OFF button to switch the machine off.
- Remove the plug from the power socket.
- Screw the water inlet hose back on and put the drain hose back in its place.

By doing this, any water remaining in the machine is removed, avoiding the formation of ice and, consequently, damage to the appliance.

When you use the machine again, make sure that the ambient temperature is above 0°C.

Something not working?

- i** If, during the spin cycle, the machine makes an unusual whistling noise, different from the noise made by traditional washing machines, this is due to a new type of motor.

If water is not visible in the drum, this is due to the modern technology of new washing machines that use less water than traditional machines.

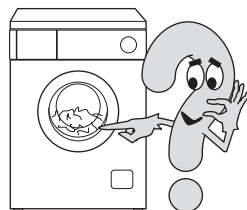

Troubleshooting

If a problem arises, you can try to solve it yourself following the instructions below.

If you call out an engineer when one of the following problems arises, or to repair a fault due to incorrect use, the call-out will be charged even if requested within the guarantee period.

During machine operation the following alarm codes may be displayed:

- **E10:** problem with the water supply
- **E20:** problem with water draining
- **E40:** door open

At the same time the light END flashes and some acoustic signals can be heard.

Once the problem has been eliminated, press the START/PAUSE button to restart the programme. If after all checks, the problem persists, contact your local AEG/ELECTROLUX Service Force Centre.

Problem	Possible cause	Solution
The machine does not work	The ON/OFF button has not been depressed.	Depress the button.
	The main electrical or the plug fuse have blown.	Replace the fuse.
	The door is not properly closed (E40).	Close the door; the click of the lock should be heard.
	The plug is not connected.	Insert the plug.
	The START button has not been pressed.	Press the button.
	The DELAY START option has been selected.	Check the selected delay on the display.

Problem	Possible cause	Solution
The machine does not fill	The water tap is closed (E10) .	Open the water tap.
	The water inlet hose is squashed or kinked (E10) .	Check the whole length of the hose and remove the kink.
	The small filter of the water inlet hose is clogged (E10) .	Clean the filter.
	The door is not properly closed (E40) .	Close the door.
The machine fills then empties immediately	The end of the drain hose is too low.	Place the hose at the right height (see Installation section).
The machine does not empty and/or does not spin	The drain hose is squashed or kinked (E20) .	Check the whole length of the hose and remove the kink.
	The drain filter (EFO) or the drain hose are clogged (E20) .	Clean the filter or check the hose.
	The RINSE HOLD option (stop with water in drum) has been selected.	Empty out the water by selecting the drain or spin programme.
	The laundry is not evenly distributed inside the drum.	Redistribute the laundry manually in the drum.
There is water on the floor	Too much detergent has been used.	Measure detergent according to the manufacturer's instructions.
	An unsuitable detergent has been used that creates too much foam.	Use a suitable washing machine detergent.
	One of the connectors on the water inlet hose is leaking.	Check that the hose is firmly screwed on at both ends.
	The drain filter has not been properly screwed on after cleaning.	Fully screw the filter into place.

Problem	Possible cause	Solution
The machine vibrates or is noisy	The transit bolts have not been removed.	Check that the machine has been unpacked as described in the Installation section.
	The feet have not been adjusted.	Carefully level the machine.
	There is little laundry in the drum.	Correct operation of the machine is not affected.
The door will not open	The programme is still running.	Wait until the end of the programme before opening the door.
	The water level is above the bottom edge of the door.	Before opening the door, the water must be emptied out.
	The machine is heating the water.	Wait until the end of the heating phase.

Problem	Possible cause	Solution
Spinning starts late or the machine does not spin	The unbalance detection device that prevents excessive vibration during spinning has cut in.	<p>If the laundry is not evenly distributed inside the drum at the beginning of the spin cycle, the machine detects this and tries to redistribute it more evenly by means of a few drum rotations.</p> <p>Only when the laundry is more evenly distributed will the spin cycle be performed, at a lower speed, if the laundry is not evenly distributed.</p> <p>If, after about 6 minutes, the laundry is still tangled, the machine will not spin. Therefore, if the laundry is still wet at the end of the cycle, it is advisable to redistribute it manually inside the drum and to select the spin programme again.</p>

Unsatisfactory washing results

If the laundry looks grey and lime scale is found in the drum

- Too little detergent has been used.
- An unsuitable detergent has been used.
- Stubborn stains have not been treated prior to washing.
- The programme/temperature has not been correctly selected.

If grey stains remain on the laundry

- Laundry stained with ointments, grease or oil has been washed with an insufficient amount of detergent.
- The temperature selected for the wash programme was too low.
- Fabric softener – especially the concentrated type – has come into direct contact with the laundry. Wash these stains immediately and pour fabric softener carefully.

Foam is still visible even after the last rinse

- Modern detergents often produce foam, even in the last rinse. However the laundry has been completely rinsed.

White residue is left on the laundry

- This is due to insoluble components in modern detergents and is therefore not the result of insufficient rinsing. Shake or brush the laundry. In future, it may be better to turn garments inside out before washing them. Check the choice of detergent; try using liquid detergents.

Technical data

Height x Width x Depth	82x60x54.5 cm
Depth with door opened	95 cm
Height adjustment	± 13 mm approx.
Load (depending on programme)	5 kg max.
Use	domestic
Drum speed during washing	max. 55 rpm
Drum speed during spinning	1200/900/700/500 rpm (L12510VI) 1400/900/700/500 rpm (L14510VI)
Water pressure	0.05 - 0.8 MPa



This appliance complies with the following EC directives:

- 73/23/EEC of 19.2.1973 "Low voltage directive", including directive 93 / 68 / EEC
- 89/336/EEC of 3.5.1989 "Electromagnetic Compatibility Directive".

Service & Spare Parts

If after carrying out the necessary checks there is still a fault with your appliance please contact your local AEG/ELECTROLUX Service Force Centre.

In guarantee customers should ensure that the suggested checks in the "Troubleshooting" section have been made as the engineer will make a charge if the fault is not a mechanical or electrical breakdown.

Please note that proof of purchase is required for in-guarantee service calls.

Service & Spare Parts

To buy accessories, consumables and spare parts at our online shop please visit: <http://www.aeg-electrolux.co.uk>

If you require a service engineer or wish to purchase spare parts, contact your local AEG/ELECTROLUX Service Force Centre, by telephoning:

08705 929 929

Help us to help you

Please determine your type of enquiry before telephoning. When you contact us we need to know:

1. Your name, address and post code.
2. Your telephone number.
3. Clear and concise details of the fault.
 - What is the fault?
 - When does the fault occur?
 - Does the multi-display issue an error-message (E and a number)?
4. The model, production number and production identification number.
5. Date of purchase.

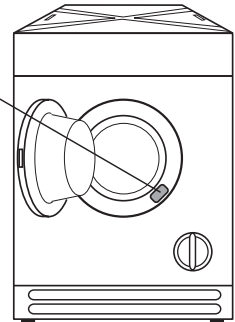
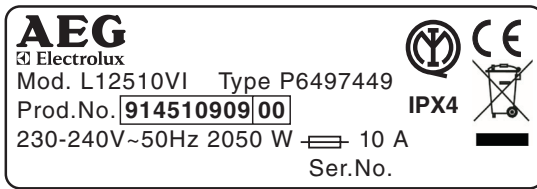

This information can be found on the rating plate, so you have these numbers to hand we recommend you write them below.

Prod. No.

Ser. No.

Customer care

For general enquiries regarding your AEG/ELECTROLUX appliance, or further information on AEG/ELECTROLUX products please contact our Customer Care Department at the address below or visit our website at: www.aeg-electrolux.co.uk

Customer Care Department
AEG/ELECTROLUX Major Appliances
Addington Way
Luton
Bedfordshire LU4 9QQ
Tel: 08705 350350*

*Calls to this number may be recorded for training purposes.

Guarantee Conditions

AEG/ELECTROLUX offer the following guarantee to the first purchaser of this appliance.

1. The guarantee is valid for 12 months commencing when the appliance is handed over to the first retail purchaser, which must be verified by purchase invoice or similar documentation.

The guarantee does not cover commercial use.

2. The guarantee covers all parts or components which fail due to faulty workmanship or faulty materials. The guarantee does not cover appliances where defects or poor performance are due to misuse, accidental damage, neglect, faulty installation, unauthorised modification or attempted repair, commercial use or failure to observe requirements and recommendations set out in the instruction book.

This guarantee does not cover such parts as light bulbs, removable glass-ware or plastic, dust bags or filters.

3. Should guarantee repairs be necessary the purchaser must inform the nearest customer service office (AEG/ELECTROLUX's service or authorised agent). AEG/ELECTROLUX reserves the right to stipulate the place of the repair (i. e. the customer's home, place of installation or AEG/ELECTROLUX workshop).
4. The guarantee or free replacement includes both labour and materials.
5. Repairs carried out under guarantee do not extend the guarantee period for the appliance. Parts removed during guarantee repairs become the property of AEG/ELECTROLUX.
6. The purchaser's statutory rights are not affected by this guarantee.

European Guarantee

If you should move to another country within Europe then your guarantee moves with you to your new home subject to the following qualifications:

- The guarantee starts from the date you first purchased your product.
- The guarantee is for the same period and to the same extent for labour and parts as exist in the new country of use for this brand or range of products.
- This guarantee relates to you and cannot be transferred to another user.
- Your new home is within the European Community (EC) or European Free Trade Area.
- The product is installed and used in accordance with our instructions and is only used domestically, i.e. a normal household.
- The product is installed taking into account regulations in your new country.

Before you move please contact your nearest Customer Care Centre, listed below, to give them details of your new home. They will then ensure that the local Service Organisation is aware of your move and able to look after you and your appliance.

France	Senlis	+33 (0) 44 62 29 29
Germany	Nürnberg	+49 (0) 911 323 2600
Italy	Pordenone	+39 (0) 1678 47053
Sweden	Stockholm	+46 (0) 8 738 7910
UK	Luton	+44 (0)8705 350350

Instructions for installation and electrical connection



Safety instructions for the installer

- This appliance is heavy, care should be taken when moving it.
- When unpacking the appliance, check that it is not damaged. If in doubt, do not use it and contact the retailer.
- All internal packing must be removed before using the appliance. Serious damage may be caused to the machine or adjacent furniture if the protective transit devices are not removed or are not completely removed. Refer to the relevant paragraph.
- Any electrical work required to install this appliance must be carried out by a qualified electrician or competent person.
- Any plumbing work required to install this appliance must be carried out by a qualified plumber or competent person.
- After having installed the machine, check that it is not standing on its electrical supply cable.
- If the appliance is placed on a carpeted floor, ensure that air can circulate freely between the adjustable feet and the floor.
- The installation should comply with local water authority and building regulations requirements.
- Should the appliance power supply cable need to be replaced, this should be carried out by our Service Force Centre.

Dimensions of the appliance

Front view and side view

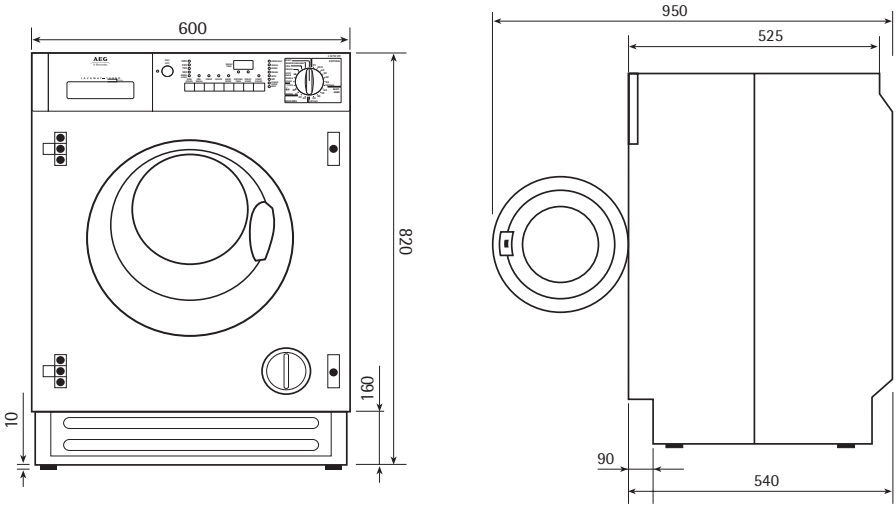

Rear view

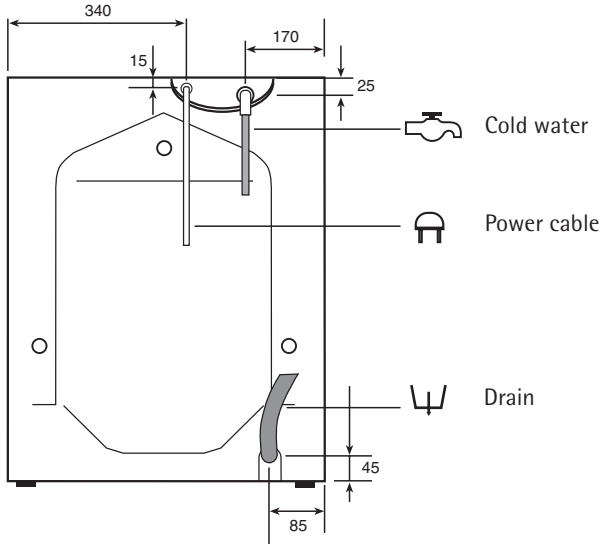



Installation

Unpacking

 All transit bolts and packing must be removed before using the appliance.

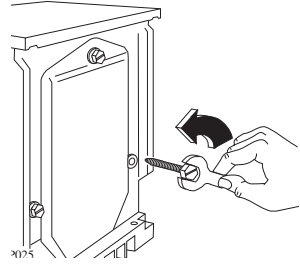
 Using the supplied spanner, unscrew and remove the rear right-hand bolt and lay the machine on its back, taking care not to squash the hoses. This can be avoided by placing one of the corner packing pieces between the machine and the floor.



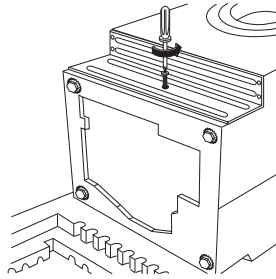

 Remove the polystyrene base and take off the bottom panel by unscrewing the central screw.

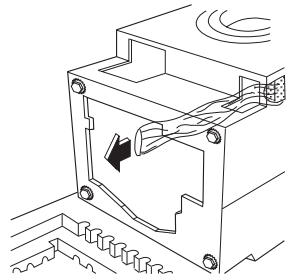

 Carefully slide out the right poly-thene bag.



 Repeat the operation for the left and central poly-thene bags.

 Re-fit the bottom panel using the 4 screws supplied with the door hinges (in the plastic bag) and the previously removed screw.

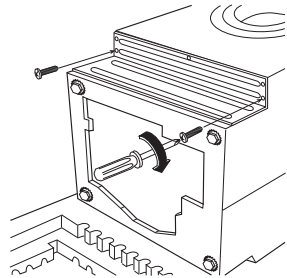
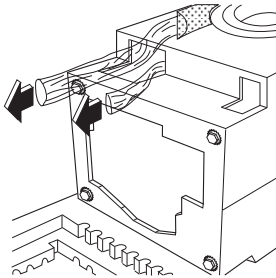

- ☞ Set the machine upright and remove the two remaining bolts from the back.
- ☞ Pull out the three plastic spacers from the holes into which the bolts were fitted.
- ☞ Plug the open holes with the plugs which you will find in the plastic bag containing the instruction booklet.

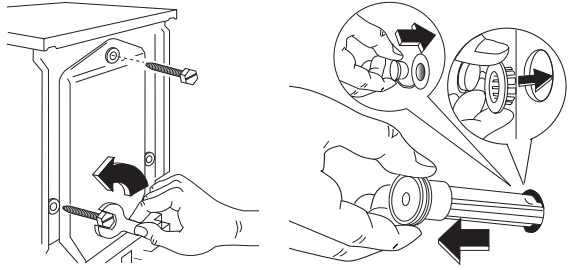

You are advised to keep all transit devices so that they can be refitted if the machine ever has to be transported again.

Positioning

Install the machine on a flat hard floor.

Make sure that air circulation around the machine is not impeded by carpets, rugs etc.

- Before placing it on small tiles, apply a rubber coating.
- Never try to correct any unevenness in the floor by putting pieces of wood, cardboard or similar materials under the machine.
- If it is impossible to avoid positioning the machine next to a gas cooker or coal-burning stove, an insulating panel (85x57 cm) covered with aluminium foil on the side facing the cooker or stove, must be inserted between the two appliances;
- The machine must not be installed in rooms where the temperature can drop below 0°C.
- The water inlet hose and the drain hose must not be kinked.
- Please ensure that when the appliance is installed, it is easily accessible for the engineer in the event of a breakdown.

Levelling

Carefully level by screwing the adjustable feet in or out. Never place cardboard, wood or similar materials under the machine to compensate for any unevenness in the floor.

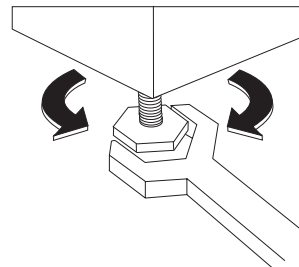

Water inlet (cold water connection only)

Connect the hose to a tap with a 3/4" thread.

Installation should comply with local water authority and building regulations' requirements.

Set the hose correctly by loosening the ring

nut. After positioning the inlet hose, be sure to tighten the ring nut again to prevent leaks.

Do not connect to a hot water supply.

The inlet hose is provided with a water stop device, which protects against damage caused by water leaks in the hose which could develop due to natural ageing of the hose. This fault is shown by a red sector in the window "A". Should this occur, turn the water tap off and refer to your Service Force Centre to replace the hose.

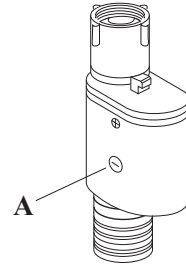
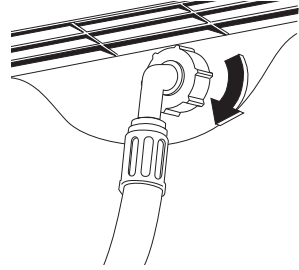
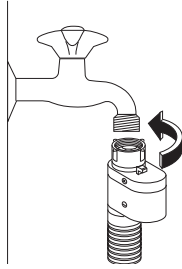

Water drainage

This appliance is designed to be permanently plumbed into your home's drainage system using one of the following methods.

1. Into a drainage standpipe.

Firstly form a hook in the end of the drain hose using the "U" piece" supplied.

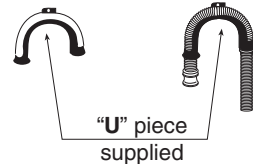

Place the drain hose into your standpipe, which should have an internal diameter of approximately 38mm thus ensuring there is an air break between the drain hose and standpipe.

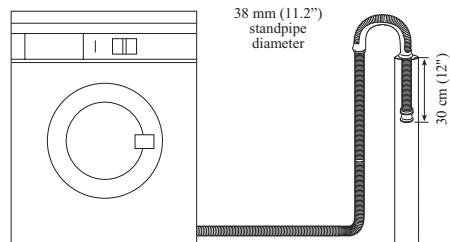

When discharging into a standpipe ensure that the top of the standpipe is no more than 90 cm (35.4") and no less than 60 cm (23.6") above floor level.

The drain hose may be extended to a maximum of 4 metres. An additional drain hose and joining piece is available from your local Service Force Centre. The joining piece must have an internal diameter of 18 mm.

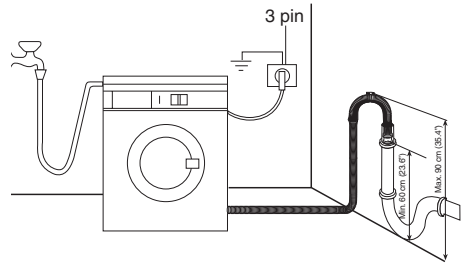

2. Onto a sink outlet spigot.

If the outlet spigot has not been used before, remove any blanking plug that may be in place.

Push the drain hose onto the spigot and secure with a clip if required, ensure a

loop is formed in the drain hose (see diagram) to prevent waste from the sink entering the washing machine.

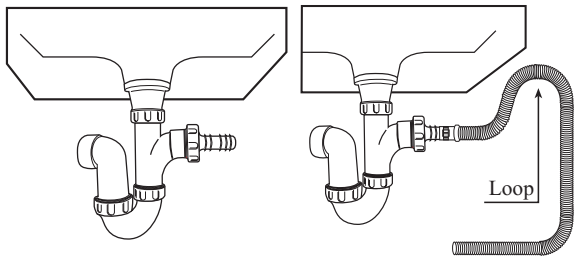

The drain hose may be extended to a maximum of 4 metres. An additional drain hose and joining piece is available from your local Service Force Centre. The joining piece must have an internal diameter of 18 mm.

If you intend the drain hose from the machine to empty into a sink, make sure that the sink is empty and the plug hole is not blocked. Use the plastic "U -Piece" supplied.

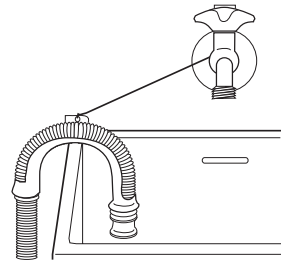

Important

Before connecting up the machine to new pipework or to pipework that has not been used for some time, run off a reasonable amount of water to flush out any debris that may have collected in the pipes.

In the interest of the environment

Washing machines and dishwashers should be connected to the FOUL drainage system, the water will then be taken to a sewage works for treatment before being discharged safely into a river.

It is essential that these appliances are not connected to the surface water drainage system as this water is discharged directly into a river or stream and may cause pollution.

If you require any further advice please contact your local water authority.

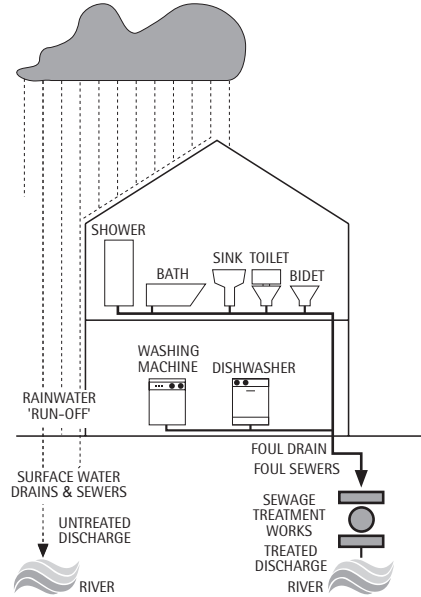

Electrical connections



WARNING: THIS APPLIANCE MUST BE EARTHED.

The manufacturer declines any liability should this safety measure not be observed.

If the plug that is fitted to your appliance is not suitable for your socket outlet, it must be cut off and the appropriate plug fitted.

Remove the fuse from the cut off plug.

The cut off plug should then be disposed of to prevent the hazard of shocks in case it should be plugged into a 13 Amp socket in another part of your home.

Important

The wires in the mains lead are coloured in accordance with the following code:

- | | |
|------------------|-----------|
| Green and Yellow | - Earth |
| Blue | - Neutral |
| Brown | - Live |

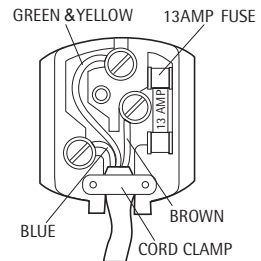

If you fit your own plug, the colours of the wires in the mains lead of your appliance may not correspond with the markings identifying the terminals in your plug, proceed as follows:

Connect the green and yellow (earth) wire to the terminal in the plug which is marked with the letter «E» or the earth symbol \perp or coloured green and yellow.

Connect the blue (neutral) wire to the terminal in the plug which is marked with the letter «N» or coloured black.

Connect the brown (live) wire to the terminal in the plug which is marked with the letter «L» or coloured red.

The plug moulded on to the lead incorporates a fuse. For replacement, use a 13 Amp BS1362 fuse. Only ASTA or BSI approved fuses should be used.

The plug must not be used if the fuse cover/carrier is lost. The cover/carrier is indicated by the coloured insert at the base of the plug.

A replacement cover/carrier must be obtained from your local AEG/ELECTROLUX Service Centre.

Permanent connection

In the case of a permanent connection it is necessary that you install a double pole switch between the appliance and the electricity supply (mains), with a minimum gap of 3 mm between the switch contacts and of a type suitable for the required load in compliance with the current electrical regulations.

The switch must not break the yellow and green earth cable at any point.

This operation should only be performed by a qualified electrician.

Building-in

This appliance has been designed to be built into the kitchen furniture. The recess should have the dimensions shown in picture A.

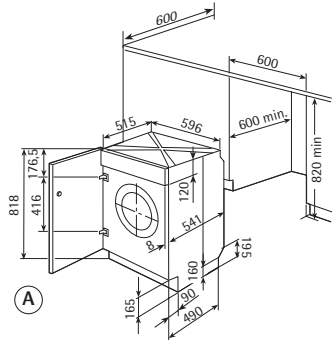

When installing the appliance into the kitchen furniture ensure, if possible, the hoses are placed in either of the two recesses on the back of the appliance. This will help to prevent the hoses from becoming kinked or trapped. Picture AB.

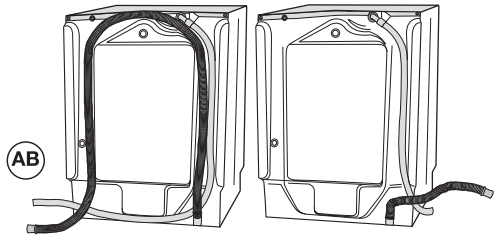

Preparation and assembly of the door

The machine is originally pre-arranged for the assembly of a door opening from right to left. In this case it is sufficient to screw in the hinges (1) and the counter-magnet (6) provided with the appliance, at the right level (Fig. B).

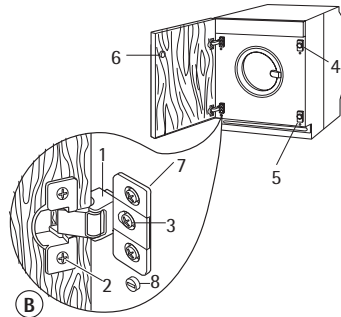

a) Door

The dimensions of the door should be:

- width 595-598 mm
- thickness 16-22 mm

The height (C-Fig. C) depends on the height of the adjacent furniture's base.

b) Hinges

To mount the hinges it is necessary to drill two holes (dia. 35 mm, depth 12.5-14 mm) on the inner side of the door. The distance between the holes hobs fixing centres must be 416 mm.

The distance (B) from upper edge of the door to the centre of the hole depends on the adjacent furniture's dimensions.

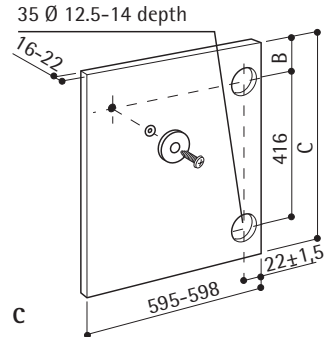

The required dimensions are given in the picture C.

The hinges will be fixed to the door by means of screws for wood (2-Fig. B) supplied with the appliance.

c) Mounting the door

Fix the hinges (1) to the machine by means of the M5x15 screws (3-Fig. B). The hinges can be adjusted to compensate for possible uneven thickness of the door.

To align the door perfectly it is necessary to loosen the screw (3-Fig. B), adjust the door and tighten the screw again.

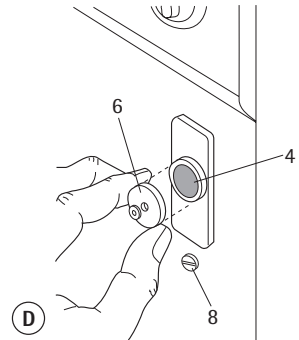

d) Counter-magnet (6)

The appliance is pre-arranged for a magnetic closure of the door. To enable a correct operation of this device, it is necessary to screw the counter-magnet (6) (steel disk + rubber ring) into the inner side of the door.

Its position must correspond to the magnet (4) on the appliance (see picture D).

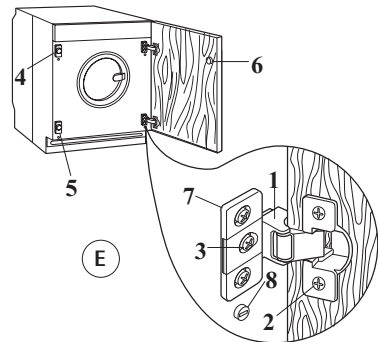

If the door has to be opened from left to right, invert the position of the plates (7), the magnet (4) and the plate (5) (Fig. B and E). Mount the counter-magnet (6) and the hinges (1) as previously described.

Important: the plastic screw (8) should **never** be loosened (Fig. B and E).

Recommendations regarding the construction and fitting of a base when the installation requires an integrated appliance to be raised

Where the appliance has been raised by mounting onto a wooden base provided by the installer. The material used to construct the base should have a non slip surface, be water repellent and if possible be one solid piece.

If it is not possible to use one solid piece, due to the additional height required, ensure that any additional strips of timber are glued and screwed to the underside of the base (see Fig. F).

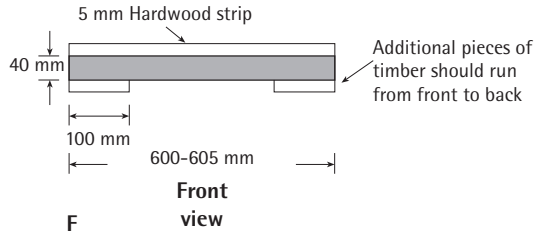

Drill four fixing holes see Fig. G

Position the base into the recess with its front edge as far forward as the adjoining plinth line will allow. **The reason for placing the base in this position is to allow a small strip of beading to be fitted in front of the appliance feet.**

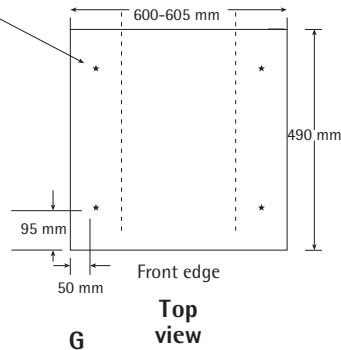

Fix the base firmly to the floor using four appropriate countersunk screws (see Fig. H).

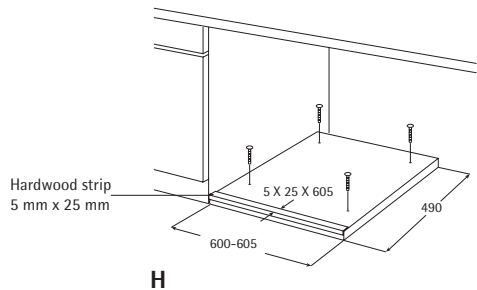

With the appliance installed adjust all four feet ensuring the machine is stable, and a clearance of approximately 5 mm is left between the top of the machine and the underside of the worktop.

A final check for stability should be carried out with the machine on spin with a load, this will identify the need for any further fine adjustment to the feet.

A strip of beading approximately 605 mm W, x 5 mm H, x 25 mm D must be screwed down into the base directly in front of the machine's feet, this will provide additional security.

If required an additional door magnet, part number 1242394-00/3 and disc, part number 1242393-00/5 are available from spare parts.

AEG/ELECTROLUX Hausgeräte GmbH
Postfach 1036
D-90327 Nürnberg

<http://www.aeg-electrolux.hausgeraete.de>

© Copyright by AEG/ELECTROLUX

132.984.470-01-0905 Subject to change without notice.



From the Electrolux Group. *The world's No. 1 choice.*

The Electrolux Group is the world's largest producer of powered appliances for kitchen, cleaning and outdoor use. More than 55 million Electrolux Group products (such as refrigerators, cookers, washing machines, vacuum cleaners, chain saws and lawn mowers) are sold each year to a value of approx. USD 14 billion in more than 150 countries around the world.