

LAVAMAT L 60895 - 62895

La lavadora ecológica
The environmentally friendly washing machine

Instrucciones para el uso
Instruction booklet

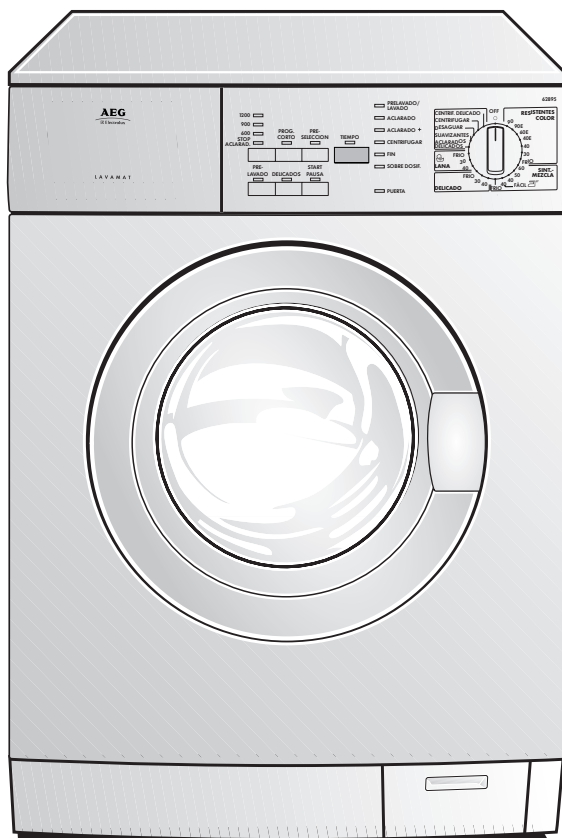





PERFEKT IN FORM UND FUNKTION

AEG

Electrolux

Dear customer,

Please read these operating instructions carefully and pay particular attention to the safety notes indicated in the first pages. We recommend that you keep this instruction booklet for future reference and pass it on to any future owners.

-  The warning triangle and/or the key words (Warning!, Caution!) emphasize information that is particularly important for your safety or correct functioning of the appliance.
-  This symbol guides you, step by step, in the operation of the appliance.
-  The information marked with this symbol provides additional instructions and practical tips on the use of the appliance.
-  Tips and information about economical and ecological use of the machine are marked with the clover symbol.

Should any problems arise, this booklet provides instructions on how to solve them by yourself; see section "Something not working?".

If this information is not sufficient, please contact our nearest SERVICE CENTRE.

Printed on recycled paper.
People who think ecologically, act accordingly...

Contents

Safety instructions	48-49
Disposal	50
Tips for environmental protection	50
Main features of your washing machine	51
Description of the appliance	52
Control panel.....	53
Programme selector dial.....	53
START/PAUSE (START/PAUSA) button.....	54
DELAY START (PRESELECCIÓN) button.....	54
Programme Option buttons.....	55
PREWASH (PRELAVADO).....	55
SENSITIVE (DELICADOS).....	55
QUICK WASH (PROGRAMA CORTO).....	55
SPIN SPEED (CENTRIFUGADO).....	55
RINSE HOLD (STOP ACLARADO).....	56
Display (TIEMPO).....	56
Programme progress display.....	56
Cancelling a programme.....	57
Altering a programme which is running.....	57
Altering an option which is running.....	57
Opening the door after the programme has started.....	57
Detergent dispenser drawer.....	58
Before the first wash	58
Preparing the wash cycle	59
Sorting out and preparing the laundry.....	59
Weight of laundry.....	60
Types of fabric and care labels.....	60-61
Detergents and additives.....	62
Which detergent and additive?.....	62
How much detergent?.....	62
Liquid detergent.....	62
Adding a water softener (descaling product).....	62
Information on water hardness.....	62

How to wash	63
Load the laundry	63
Add detergent and additives	63
Select the desired wash programme	64
Select the desired options	64
Select the SPIN SPEED or RINSE HOLD option	64
Select the EXTRA RINSE	65
Select the DELAY START option	65
Starting the programme	66
Programme progress display	67
Display	67
At the end of the programme	67
Programme charts: wash and special programmes	68-70
Cleaning and maintenance	71
After each wash	71
Periodical cleaning	71
Exterior	71
Detergent dispenser drawer	71
Door seal	72
Drain pump	72
Water inlet filter	73
Emergency emptying out	73
Frost precautions	74
Something not working?	75
Troubleshooting	75-77
Unsatisfactory washing results	78
Technical data	79
Service	80
Instructions for installation and electrical connection	81
Safety instructions for the installer	81

Installation	82-83
Unpacking	82
Positioning	83
Levelling	84
Water inlet	84
Water drainage	85
Electrical connection	86
Permanent connection	86



Safety instructions

The safety of AEG/ELECTROLUX appliances complies with the industry standards and with legal requirements on the safety of appliances. However, as manufacturers, we feel it is our duty to provide the following safety notes.

General safety

- Repairs to the machine must be carried out only by qualified personnel. Repairs carried out by inexperienced persons could cause serious danger. Contact your local AEG/ELECTROLUX Service Force Centre.
- Never start the machine if the electrical supply cable is damaged or the control panel or worktop are so damaged that inner components can be reached.
- Unplug the appliance before carrying out any cleaning or maintenance operations.
- Never pull the power supply cable to remove the plug from the socket; always take hold of the plug itself.
- Never spray the machine with a jet of water. Danger of electric shock!
- During high temperature wash programmes the door glass may get hot. Do not touch it!
- Let the water cool down before carrying out emergency emptying or before opening the door in an emergency.
- Small animals can gnaw electric wires and water hoses causing electrocution hazard and damage due to water leaks.

Positioning, connection, starting up

- Follow the **instructions for positioning and connection**.
- Carry out a first wash without laundry (COTTONS 90, with half the amount of detergent) in order to remove any manufacturing residue from the tub and the drum.
- Should the machine be purchased in winter, when temperatures can be below 0°, leave the appliance for 24 hours at ambient temperature before starting it.

Child safety

- Children are often not aware of how dangerous electrical appliances can be. When the machine is working, children should be carefully supervised and not be allowed to play with the appliance - there is a risk that they could become trapped inside.
- The packaging components (e.g. plastic film, polystyrene) can be dangerous to children - danger of suffocation! Keep them out of children's reach.
- Keep all detergents in a safe place out of children's reach.
- Make sure that children or pets do not climb into the drum.
- When the appliance is to be scrapped, cut off the electrical supply cable and destroy the plug with the remaining cable. Disable the door catch in order to prevent children from becoming trapped inside while playing.

Proper use

- This appliance is designed for domestic use only. If the machine is used for any other purposes or is not used correctly, the manufacturer accepts no responsibility for any damage that might occur.
- For safety reasons, the appliance must not be modified.
- Use only detergents suitable for washing machines and follow the manufacturer's instructions.
- Garments which have been in contact with flammable solvents should not be machine washed.
- Do not use your machine for dry cleaning.
- Dyes and bleaching agents may only be used if specifically permitted by the manufacturer of these products. We cannot be held responsible for any damage.
- Always unplug the appliance and turn off the water tap after use.



Disposal

Packaging materials

The materials marked with the symbol  are recyclable.

>PE<=polyethylene

>PS<=polystyrene

>PP<=polypropylene

This means that they can be recycled by disposing of them properly in appropriate collection containers.

Machine

Use authorised disposal sites for your old appliance. Help to keep your country tidy!

The symbol  on the product or on its packaging indicates that this product may not be treated as household waste. Instead it shall be handed over to the applicable collection point for the recycling of electrical and electronic equipment. By ensuring this product is disposed of correctly, you will help prevent potential negative consequences for the environment and human health, which could otherwise be caused by inappropriate waste handling of this product. For more detailed information about recycling of this product, please contact your local city office, your household waste disposal service or the shop where you purchased the product.



Tips for environmental protection

To save water, energy and to help protect the environment, we recommend that you follow these tips:

- Normally soiled laundry may be washed without prewashing or soak in order to save detergent, water and time (the environment is protected too!).
- Use the energy saving programme when washing normally soiled garments.
- The machine works more economically if it is fully loaded.
- When small loads are washed, use only half to two thirds of the recommended amount of detergent.
- With adequate pre-treatment, stains and limited soiling can be removed; the laundry can then be washed at a lower temperature.

- If the water has a medium or high degree of hardness (starting from hardness degree II, see "Detergents and additives") water softeners must be added.
The amount of detergent can then be adjusted to hardness degree I (= soft).

Main features of your washing machine

- Programme and temperature setting using the programme selector.
- **Energy saving programmes (90E), (60E), (40E)** for normally soiled cotton items.
- **Speed for the final spin** can be reduced to 900, 600 rpm for L62895 and 800, 600 rpm for L60895.
- **RINSE HOLD:** the laundry is left immersed in the final rinse water to prevent creasing.
- **Delay Start:** programme start can be delayed up to 23 hours (e.g. to times with a more economical power rate).
- **Programme progress display** showing the programme steps selected and the programme phase which is running.
- Because of its gentle washing action, the **special wool cycle** washes your garments with extreme care.
- **3-compartment drawer** for detergent and fabric softener.
- **Balance control device:** to prevent vibration during spinning.
- **The ECO valve** allows total use of detergent and reduces water consumption so saving energy.

Description of the appliance

Front view

Detergent drawer

Control panel

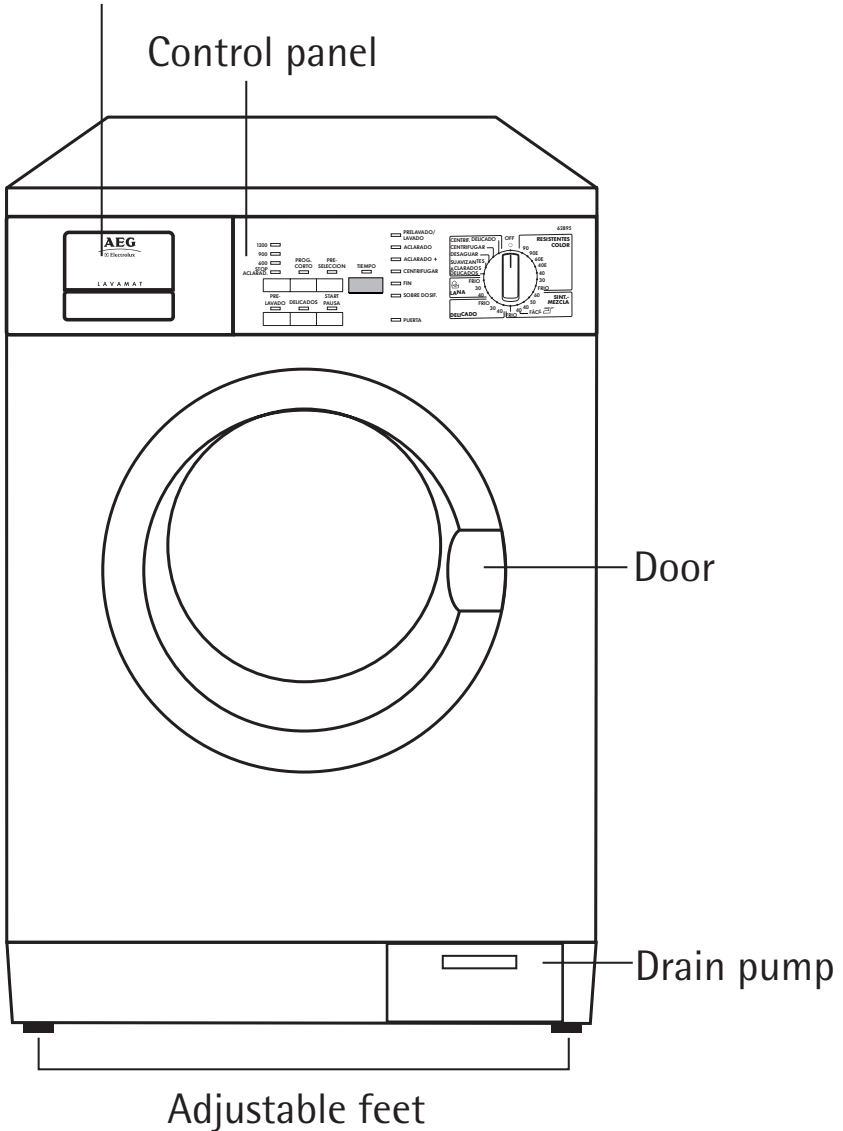

Control panel

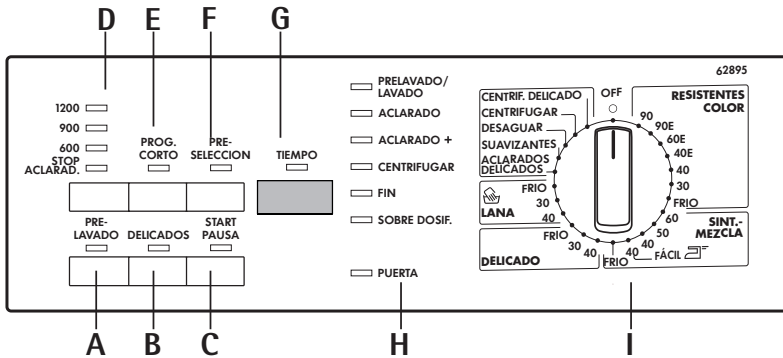

A = PREWASH button

B = SENSITIVE button

C = START/PAUSE button

D = SPIN SPEED button

E = QUICK WASH button

F = DELAY START button

G = Display

H = Programme progress display

I = Programme selector dial

Programme selector dial

The programme selector determines the type of washing cycle (e.g. water level, drum movement, number of rinses) and the washing temperature according to the type of laundry.

The selector dial is divided into 5 sections:

- Cottons (RESISTENTES COLOR)
- Synthetics (SINT.-MEZCLA)
- Delicates (DELICADO)
- Woollens (LANA)  (hand washing)
- Special programmes
- Reset programme **O/OFF**

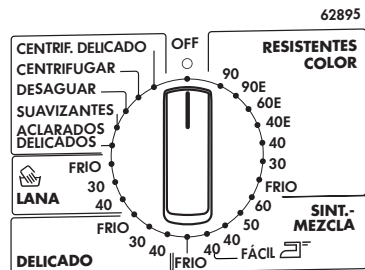

The selector dial can be turned either clockwise or anticlockwise.



Position **90E**, **60E** and **40E (economy)** corresponds to the ENERGY SAVING programme for normally soiled laundry, extended washing time. They cannot be combined with QUICK WASH (PROG. CORTO) option.

Position EASY TO IRON at 40°C (FÁCIL )

In this position the laundry is gently washed and spun to avoid any creasing. In this way ironing is easier.

Position FRIO = cold wash

START/PAUSE button (START/PAUSA)

This button has two functions:

a) Start

After having selected the required programme, press this button to start the machine. If you have selected the DELAY START option (PRESELECCIÓN), the machine starts its hourly countdown.

b) Pause

To interrupt a programme which is running, press the START/PAUSE button: the relevant light starts to flash.

To restart the programme from the point at which it was interrupted, **press the START/PAUSE button again.**

DELAY START button (PRESELECCIÓN)

The wash programme can be delayed from 30 min – 60 min – 90 min, 2 hours and then by 1 hour up to a maximum of 23 hours by means of this button.

Selecting the delayed start

- Select the programme and the required options.
- Select the delay start.
- Depress START/PAUSE button: the machine starts its hourly count down.

The programme will start after the selected delay has expired.

Cancelling the delayed start

- Depress START/PAUSE button.
- Depress DELAY START button until the the symbol  is displayed.
- Depress START/PAUSE button again to restart the machine
- To modify the delay time, after the programme has already started, set the programme again and select the new desired delay time.

Programme Option buttons

Depending on the programme, different functions can be combined. These must be selected after choosing the desired programme and before depressing the START/PAUSE button.

When these buttons are pressed, the corresponding pilot lights come on. When they are pressed again, the pilot lights go out.

PREWASH (PRELAVADO)

The machine performs a prewash cycle before the main wash. The prewash cycle ends with a short spin in programmes for Cotton and Synthetics, and with emptying of the water without spinning for Delicates. To be used for heavily soiled laundry.

SENSITIVE (DELICADOS)

If you depress this button, the washing machine adds one rinse in COTTONS and SYNTHETIC programmes and reduces the spinning of the drum and the washing intensity. To be used for delicate color or lightly soiled cottons.

This option **cannot be** selected with the EASY IRON programme.

QUICK WASH (PROG. CORTO)

By pressing this button the washing time is reduced. For use when washing lightly soiled laundry.

This option is **not available** with programme wool, handwash and economy programmes.

Important: By depressing at the same time buttons SPIN SPEED and QUICK WASH, the acoustic signal is suppressed when selecting the programmes, in case of incorrect option selection and at the end of the cycle.

SPIN SPEED (CENTRIFUGADO)

Press this button to reduce the maximum speed of the final speed proposed by the machine for the selected programme or to select option RINSE HOLD.

The maximum spin speed for cotton is:

- 1200 rpm for L62895
- 1000 rpm for L60895.

For synthetics, wool and delicates is 1000 rpm for L60895 and 900 rpm for L62895.

Important: By depressing at the same time buttons SPIN SPEED and DELAY START the machine will perform an extra rinse (see page 65).

1200

900

600

STOP

ACLARAD.



RINSE HOLD (STOP ACLARADO)

By selecting this option, the last rinse water is not emptied out, to prevent the fabrics from creasing. When the programme has finished, the START/PAUSE button goes off, the END pilot light (FIN) on the programme progress display illuminates, the DOOR light (PUERTA) is red and the display shows a static zero to indicate that the water must be emptied out.

To empty out water there are two possibilities:

- Select programme "DESAGUAR" (draining):

The water is emptied out without spinning.

- Select programme "CENTRIFUGAR" (SPIN) or "CENTRIF. DELICADO" (DELICATE SPIN). Select the spin speed by means of the relevant button and then depress the START/PAUSE button. The water is emptied out and the laundry is spun at the selected spin speed.

Warning! The programme selector dial must be turned first to RESET  and then to the DRAIN programme "DESAGUAR" or "CENTRIFUGAR" (SPIN) or "CENTRIF. DELICADO" (DELICATE SPIN).

Display (TIEMPO)

The display shows the following information:

- **Duration of the selected programme (in minutes)**, calculated automatically on the basis of the maximum recommended load for each type of fabric.
- When the programme has finished, a **steadily lit zero** is displayed.
- **Delay start**, (23 hours max.) programmed using the button PRESELECCIÓN. The countdown is updated every hour during the first two hours and then every thirty minutes.
- **Alarm code** indicating a fault in the machine operation (see page 78).

Programme progress display

By selecting the wash programme, the pilot lights corresponding to the various phases making up the programme come on.

After the machine has started, only the running phase pilot light stays on. When the programme has finished, the FIN (End) pilot light comes on.

PREWASH/ WASH	<input type="checkbox"/>	PRELAVADO/ LAVADO
RINSES	<input type="checkbox"/>	ACLARADO
EXTRA RINSE	<input type="checkbox"/>	ACLARADO +
SPIN	<input type="checkbox"/>	CENTRIFUGAR
END	<input type="checkbox"/>	FIN
OVER- DOSAGE	<input type="checkbox"/>	SOBRE DOSIF.
DOOR	<input type="checkbox"/>	PUERTA



When the programme has finished, if the SOBREDOSIFICACION light (Overdosage) comes on, it indicates that too much detergent has been used.

Canceling a programme

To cancel a programme which is running, turn the programme selector dial to the RESET **O/OFF** position.

Warning! After a programme which ends with water in the drum (RINSE HOLD option), turn the selector dial first to **O/OFF** and then to the programme "DESAGUAR", "CENTRIFUGAR" or "CENTRIF. DELICADO".

Altering a programme which is running

To modify the selected programme turn the programme selector dial to **O/OFF** and then choose a new programme.

The water is **not** emptied out and after pressing the START/PAUSE button again the machine restarts with the newly selected programme.

Altering an option which is running

To alter an option, first set the machine to PAUSE by pressing the START/PAUSE button.

Any option can be modified before the machine starts it. After selecting the new option press the START/PAUSE button again to re-start the selected programme.

To modify the selected programme turn the programme selector dial to **O/OFF** and then choose a new programme.

The water is **not** emptied out and after pressing the START/PAUSE button again the machine restarts with the newly selected programme.

Opening the door after the programme has started

To open the door set the machine to PAUSE by pressing the START/PAUSE button.

The door can be opened if:



- the machine is not already heating;
- the water level is not above the bottom edge of the door;
- the drum is not turning.

The PUERTA light (Door) on the control panel indicates if the door can be opened:

- green light: the door can be opened;
- red light: the door cannot be opened;

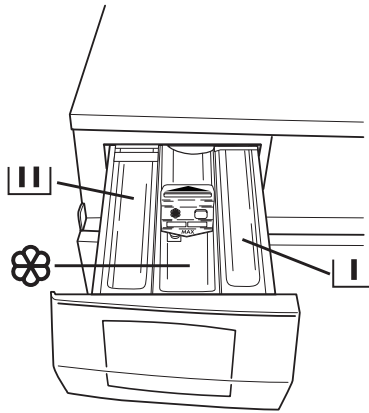
Detergent dispenser drawer



-  Compartment for prewash detergent. The prewash detergent is added at the beginning of the wash programme.
-  Compartment for powder or liquid detergent used for main wash. It is emptied at the beginning of the wash cycle.
-  Compartment for liquid additives (fabric softener, starch). It is emptied at the last rinse.

The quantity of additives must not exceed the "MAX" mark in the drawer.

Before the first wash

 Before your first wash, we recommend that you pour 2 litres of water into the main wash compartment  of the detergent drawer in order to activate the ECO valve.

 Then, run a cotton cycle at 90°, **without any laundry in the machine**, to remove any manufacturing residue from the drum and tub.

Pour 1/2 a measure of detergent into the dispenser drawer and start the machine.

Preparing the wash cycle

Sorting out and preparing the laundry

- Sort out the laundry according to type of fabrics and care labels (see "Types of fabric and care labels").
- Empty pockets.
- Remove any metal parts (safety pins, clips, etc.).
- To prevent the laundry from getting damaged and forming bundles, it is advisable to close zips, button up pillowcases and quilt covers and tie up loose straps such as those of aprons.
- Turn double faced items inside out (sleeping bags, anoraks, etc.)
- Turn coloured knitted fabrics, woollens and fabrics with trim inside out.
- Wash small and delicate items (baby socks, tights) inside a laundry net or in a pillow case closed with a zip, or in larger socks.
- Treat curtains with special care. Remove all metal or plastic hooks or put them in a net or a bag. We take no responsibility for any damage.
- Whites and coloureds must be washed separately: white items can lose their whiteness.
- New coloured fabrics often have excess dyes; it is advisable to wash them separately for the first time.
- Wash small and large items together; this improves the washing result and the laundry is better distributed during spinning.
- Shake out garments before putting them into the machine.
- Insert each garment separately.

Weight of laundry

Sort of laundry	Approximate dry weights
Bathrobes	1200 g
Work shirts	300-600 g
Quilt covers	700 g
Sheets	500 g
Blouses	100 g
Hand towels	200 g
Tea towels	100 g
Shirts	200 g
Pillowcases	200 g
Night-gowns/Pyjamas	200-250 g
Tablecloths	200-300 g
Underwear	250 g

Types of fabric and care labels

The labels on garments help you to select the most suitable wash programme. The laundry should be sorted out according to the type of fabric and the instructions indicated on care labels.

Temperatures indicated on labels are always maximum temperatures.

Cotton

Linen and cottons marked with this symbol can be washed at high temperatures.

Cotton

Linen and cottons marked with this symbol are colourfast and can be washed at 60°C.

Cotton

Garments marked with these symbols have delicate colours, therefore the washing temperature must not exceed these values.

Synthetics

Mixed and synthetic fabrics marked with these symbols require a gentle wash programme and they must therefore be washed using the specific programme.

Delicates  

Microfibres, synthetics or curtains marked with these symbols require a very gentle treatment.

The DELICATES programme is suitable for this type of fabric.

Woollens and particularly delicate items    

Fabrics such as wool, wool mix or silk marked with this symbol are particularly sensitive to machine washing.

The WOOL programme  is suitable for this type of fabric.

If the label has the symbol  (do not wash), the garments must not be machine washed!

The wool wash cycle of this machine has been approved by Woolmark for the washing of machine washable Woolmark products provided that the garments are washed according to the instructions on the garment label and those issued by the manufacturer of this washing machine. M9604.

Detergents and additives

Which detergent and additive?

Use only detergents and additives for washing machines. Follow the manufacturer's instructions.

How much detergent?

The quantity depends on:

- the load:
if the manufacturer does not provide any indications on the amount of detergent for small loads, use about one third less than the suggested amount for half loads and half the amount for very small loads;
- the degree of soil:
use a small amount of detergent for lightly soiled garments. Judge the amount according to the detergent manufacturer's instructions and size of the load;
- the water hardness:
the harder the water, the more detergent required. Instructions according to water hardness are given on the detergent pack.

Liquid detergent

Liquid detergent can be poured directly into the main wash compartment of the dispenser drawer **immediately** before starting the programme, or a special dispenser can be used that is placed directly in the drum. Measure the detergent according to the manufacturer's instructions.

Adding a water softener (descaling product)



A water softener must be added when water has a medium-high degree of hardness (from degree of hardness II). Follow the manufacturer's instructions. The quantity of detergent can then always be adjusted to degree of hardness I (= soft). Information on water hardness can be obtained from your local water supply authority.

Information on water hardness







Degree of hardness	German degrees °dH	French degrees °TH
I=Soft	0-7	0-15
II=Medium	7-14	16-25
III=Hard	15-21	26-37
IV=Very hard	more than 21	more than 37

i How to wash

Load the laundry

-  Open the door.
-  Place the laundry in the drum, one item at a time. Distribute laundry as evenly as possible. Close the door.

Add detergent and additives

-  Pull the drawer out till it stops.
-  Pour the main wash detergent into compartment .
- If you wish to perform a PREWASH programme, pour detergent or stain remover into compartment .
-  Pour the fabric softener into compartment  without exceeding the "MAX" mark.
-  Close the drawer gently, pushing it fully in.

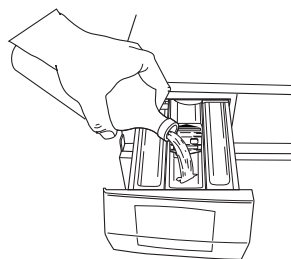
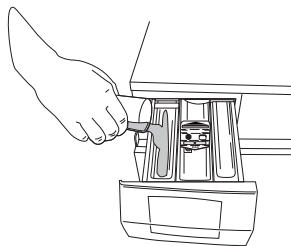

Select the desired wash programme

 Turn the programme selector dial to the desired position: the lights corresponding to the different phases making up the selected programme light on.
The display shows the duration of the programme.

- PRELAVADO/ LAVADO
- ACLARADO
- ACLARADO +
- CENTRIFUGAR
- FIN
- SOBRE DOSIF.
- PUERTA

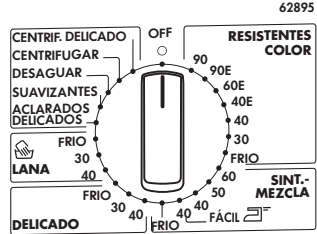

Select the desired options

depending on the degree of soil of the laundry.
The corresponding light comes on.

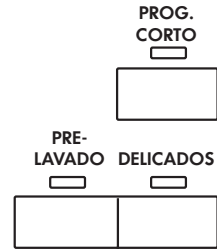



Select the spin speed or RINSE HOLD option

 It is possible to select a lower spin speed by means of the relevant button; the light corresponding to the selected speed comes on.

Selecting the option RINSE HOLD the laundry is left immersed in the final rinse water.

- 1200
- 900
- 600
- STOP ACLARAD.

 If the spin speed is not reduced, the final spin speed will be as follows:

- cottons 1200 r.p.m. (L62895)
1000 r.p.m. (L60895)
- synthetics 1000 r.p.m. (L60895)
900 r.p.m. (L62895)
- delicates 1000 r.p.m. (L60895)
900 r.p.m. (L62895)
- wool  (hand washing) 1000 r.p.m. (L60895)
900 r.p.m. (L62895)



EXTRA RINSE

This appliance is designed for saving water. However, for people with a very delicate skin (allergic to detergents) it may be necessary to rinse the laundry using an extra quantity of water (extra rinse).



The extra rinse is available only with the cotton, synthetics or delicate programme and with programme **ACLARADOS DELICADOS (RINSES)**.

Selection of the EXTRA RINSE option

 Press simultaneously the buttons CENTRIFUGADO (SPIN SPEED) and PRESELECCIÓN (DEAY START) for about 3 seconds: the light ACLARADO + comes on in the programme progress display.

This function stays permanently on. To remove it press the buttons CENTRIFUGADO (SPIN SPEED) and PRESELECCIÓN (DEAY START) again until the pilot light ACLARADO + comes off.

Select the DELAY START option

 To delay starting of a programme, press the PRESELECCIÓN (DELAY START) button **before starting the machine**. The figures corresponding to the selected delay will be displayed for about 3 seconds, after which the duration of the selected programme will appear on the display.

When the START/PAUSE button is pressed, the selected delay will appear again on the display and the machine starts its countdown.

Starting the programme

1. Check that the water tap is open and the door is closed.
 2. Press START/PAUSE to start the programme.
- If the Delay Start option has been selected the programme will start at the end of the countdown.



If the light FIN (END) is flashing at the start of the programme it indicates that the door is open. Close the door and press the START/PAUSE button again.

If the delay start option has been selected, the machine starts its countdown, in hours for the first two hours and then every 30 minutes, which will appear on the display. During this period it is possible to load other laundry, or to cancel the delay time.

- **Load other laundry:** press the START/PAUSE button. Open the door. Load the laundry. Close the door and press the START/PAUSE button again.
- **Cancel the delay time:** press the START/PAUSE button. Press the DELAY START button until the symbol σ appears on the display. Press the START/ PAUSE button again if you wish to restart the programme.

Programme progress display

By selecting the wash programme, the pilot lights corresponding to the various phases making up the programme come on. After the machine has started, only the running phase pilot light stays on.

PREWASH/ WASH	<input type="checkbox"/>	PRELAVADO/ LAVADO
RINSES	<input type="checkbox"/>	ACLARADO
EXTRA RINSE	<input type="checkbox"/>	ACLARADO +
SPIN	<input type="checkbox"/>	CENTRIFUGAR
END	<input type="checkbox"/>	FIN
OVER: DOSAGE	<input type="checkbox"/>	SOBRE DOSIF.
DOOR	<input type="checkbox"/>	PUERTA

Display

The time to the end of the programme decreases minute by minute and appears on the display.

At the end of the programme

The machine stops automatically. A steady zero appears on the display. The FIN (END) light comes on in the programme progress display, the START/PAUSE button goes off and the light PUERTA is green.



If the RINSE HOLD option has been selected, the START/PAUSE button goes off, the pilot light END on the programme progress display illuminates, the light PUERTA is red and the display shows a static zero to indicate that the water must be emptied out.

To empty out water there are two possibilities:

- Select programme **"DESAGUAR"** (draining):

The water is emptied out without spinning.

- Select programme **"CENTRIFUGAR" (spin)** or **"CENTRIF. DELICADO" (delicate spin)**. Select the spin speed by means of the relevant button and then depress the START/PAUSE button. The water is emptied out and the laundry is spun at the selected spin speed.

Warning! The programme selector dial must be turned first to **RESET O/OFF** and then to the DRAIN programme **DESAGUAR, CENTRIFUGAR (spin)** or **CENTRIF. DELICADO (delicate spin)**.



Turn the selector dial to **O/OFF** to switch the machine off.



Remove the laundry from the drum.



Check that the drum is empty so as to avoid any forgotten items being damaged in a subsequent wash (e.g. shrinking) or their colour running into a load of whites.



Close the water tap.



Leave the door open to prevent the formation of mildew and unpleasant smells.

Programme chart

Wash programmes for cottons

Wash programme	Temp.	Fabrics	Additional functions	Max. load	Consumption*	
					Energy kWh	Water lt.
White Cottons and Linens	90°	Cotton and linen, for example normally soiled work garments, sheets, household linen, underwear, towels.	PREWASH SENSITIVE QUICK WASH EXTRA RINSE RINSE HOLD SPIN SPEED	6 kg	2.3	63
90E Whites ECONOMY	90E	White cotton and linen, for example normally to lightly soiled sheets and household linen.	PREWASH SENSITIVE EXTRA RINSE RINSE HOLD SPIN SPEED	6 kg	1.55	52
60E Cottons ECONOMY	(●)60E	Whites and fast-coloureds.	PREWASH SENSITIVE EXTRA RINSE RINSE HOLD SPIN SPEED	6 kg	1.02	49
40E Coloured cottons ECONOMY	40E	Non fast-coloureds.	PREWASH SENSITIVE EXTRA RINSE RINSE HOLD SPIN SPEED	6 kg	1.14	49
Coloured cottons	40°-30° FRIO (Cold)	Coloured cotton or linen fabric, shirts, underwear, towels.	PREWASH SENSITIVE QUICK WASH EXTRA RINSE RINSE HOLD SPIN SPEED	6 kg	0.6	60



(●) In compliance with EC directive 92/75, the consumption figures indicated on the energy label refer to the "60E" wash programme for cotton.

* The consumption data shown on this chart is to be considered purely indicative, as it may vary depending on the quantity and type of laundry, on the inlet water temperature and on the ambient temperature. It refers to the highest temperature for each wash programme.

For the duration of the programmes, please refer to the display on the control panel.

Programme chart

Wash programmes for synthetics, delicates and wool

Wash programme	Temp.	Fabrics	Additional functions	Max. load	Consumption*	
					Energy kWh	Water lt.
Synthetics	60°-50° 40° FRIO (Cold)	Synthetic fabrics, underwear, coloured garments, non-shrink shirts, blouses.	PREWASH SENSITIVE QUICK WASH EXTRA RINSE RINSE HOLD SPIN SPEED	2.5 kg	0.9	54
Synthetics	40°	Synthetics, easy iron. 	PREWASH QUICK WASH EXTRA RINSE RINSE HOLD SPIN SPEED INTENSIVE	2.5 kg	0.4	59
Delicates	40°-30° FRIO (Cold)	Delicate fabrics, for example curtains.	PREWASH QUICK WASH EXTRA RINSE RINSE HOLD SPIN SPEED	2.5 kg	0.5	55
Wool  Hand wash	40°-30° FRIO (Cold)	Wool, wool mixtures, silk.	RINSE HOLD SPIN SPEED	2 kg	0.35	55

* The consumption data shown on this chart is to be considered purely indicative, as it may vary depending on the quantity and type of laundry, on the inlet water temperature and on the ambient temperature. It refers to the highest temperature for each wash programme.

For the duration of the programmes, please refer to the display on the control panel.

Programme chart

Special programmes

Programme	Description	Programme phases	Additional functions	Max. load	Consumption*	
					Energy kWh	Water lt.
ACLARADOS DELICADOS (Gentle rinses)	This programme can be used for rinsing hand washed garments.	3 rinses with liquid additive. Short spin.	EXTRA RINSE SENSITIVE RINSE HOLD SPIN SPEED	6 kg	0.05	55
SUAIVIZANTES (Softeners)	Hand washed garments to be starched or softened.	1 rinse with liquid additive. Long spin.	RINSE HOLD SPIN SPEED	6 kg		19
DESA-GUAR (Drain)	For emptying out the last rinse water in programmes with the RINSE HOLD option	The water is emptied out.		/		/
CENTRIFUGAR (Spin)	Separate spin for cottons.	Long spin.	SPIN SPEED	6 kg		
CENTRIF. DELICADO Short spin	Separate spin for synthetics, delicate fabrics and wool.	Short spin.	SPIN SPEED	2.5 kg		
O/OFF (Reset/Off)		For cancelling the programme which is running or to switch the machine off.				

* The consumption data shown on this chart is to be considered purely indicative, as it may vary depending on the quantity and type of laundry, on the inlet water temperature and on the ambient temperature. For the duration of the programmes, please refer to the display on the control panel.

Cleaning and maintenance

After each wash

- ☞ At the end of the wash programme, pull the dispenser drawer out a little to let it dry.
- ☞ Leave the door ajar to allow air to circulate.

If the machine is not used for a prolonged period:

- ☞ Close the water tap and unplug the appliance.

Periodical cleaning

Exterior

- ☞ Clean the outside of the cabinet with soap and water only. Rinse with clean water and dry.

Important: do not use methylated spirits, solvents or similar products to clean the cabinet.

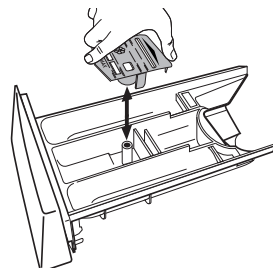

Detergent dispenser drawer

After a while, detergents and fabric softeners leave deposits in the drawer.

- ☞ Clean the drawer, from time to time, by rinsing it under a running tap. To remove the drawer from the machine, press the button in the rear left-hand corner.
- ☞ To facilitate cleaning, the top part of the additive compartments can be removed.
- ☞ Detergent can also accumulate inside the drawer recess: clean it with an old toothbrush.
- ☞ Refit the drawer after cleaning.

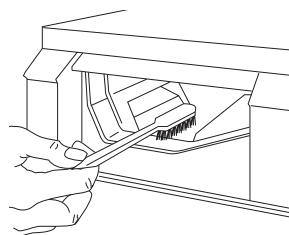

Door seal

Check from time to time the door seal and eliminate eventual possible objects that could be trapped in the fold.

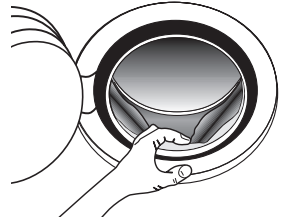

Drain pump



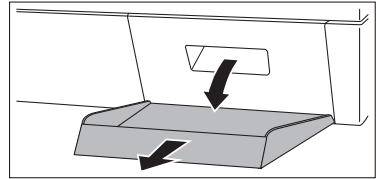

The pump should be inspected regularly and particularly if

the machine does not empty
and/or spin

the machine makes an unusual
noise during draining due to
objects such as safety pins, coins
etc. blocking the pump.



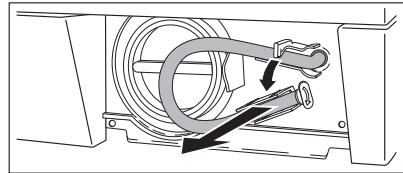

Proceed as follows:

-  Disconnect the appliance.
-  If necessary wait until the water has cooled down.
-  Open the pump door.
-  Place a container close to the pump to collect any spillage.

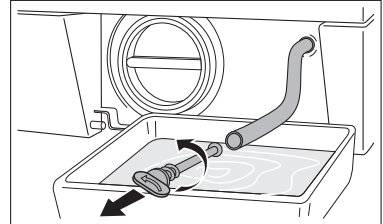

-  Release the emergency emptying hose, place it in the container and remove its cap.



-  When no more water comes out, unscrew the pump and remove it. Always keep a rag nearby to dry up spillage of water when removing the pump.

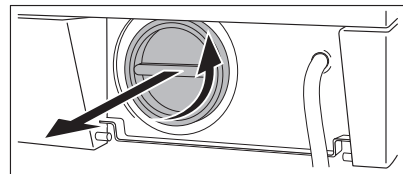

- ☞ Remove any objects from the pump impeller by rotating it.
- ☞ Put the cap back on the emergency emptying hose and place the latter back in its seat.
- ☞ Screw the pump fully in.
- ☞ Close the pump door.

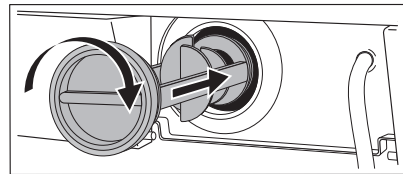
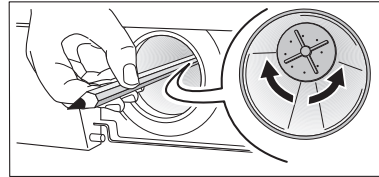
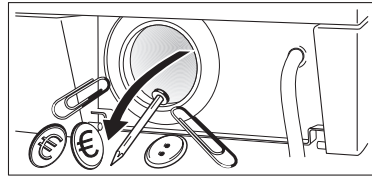

Water inlet filter

If you notice that the machine is taking longer to fill, check that the filter in the water inlet hose is not blocked.

- ☞ Turn off the water tap.
- ☞ Unscrew the hose from the tap.
- ☞ Clean the filter in the hose with a stiff brush.
- ☞ Screw the hose back onto the tap.

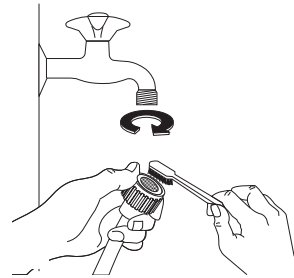



Emergency emptying out

If the water is not discharged, proceed as follows to empty out the machine:

- ☞ pull out the plug from the power socket;
- ☞ close the water tap;
- ☞ if necessary, wait until the water has cooled down;
- ☞ open the the pump door;
- ☞ place a bowl on the floor and place the end of the emergency emptying hose into the bowl. Remove its cap. The water should drain by gravity into the bowl. Whe the bowl is full, put the cap back on the hose. Empty the bowl. Repeat the procedure until water stops flowing out;
- ☞ clean the pump if necessary as previously described;
- ☞ replace the emergency emptying hose in its seat after having plugged it;
- ☞ screw the pump again and close the door.

Frost precautions

If the machine is installed in a place where the temperature could drop below 0°C, proceed as follows:

-  Close the water tap and unscrew the water inlet hose from the tap.
-  Place the end of the emergency emptying hose and that of the inlet hose in a bowl placed on the floor and let water drain out.
-  Screw the water inlet hose back on and reposition the emergency emptying hose after having put the cap on again.

By doing this, any water remaining in the machine is removed, avoiding ice forming and consequently damage to the appliance.

When you use the machine again, make sure that the ambient temperature is above 0°C.

Important!

Every time you drain the water through the emergency emptying hose you must pour 2 litres of water into the main wash compartment of the detergent drawer and then run the drain programme "C". This will activate the ECO valve avoiding that part of the detergent remains unused at next washing.

Something not working?

- i** If during the spin cycle the machine makes an unusual whistling noise, different from the noise made by traditional washing machines, this is due to a new type of motor.

If water is not visible in the drum, this is due to the modern technology of new washing machines that use less water than traditional machines.



Troubleshooting

If a problem arises, you can try to solve it yourself following the instructions below.

If you call out an engineer when one of the following problems arises, or to repair a fault due to incorrect use, the call-out will be charged even if requested within the guarantee period.

During machine operation it is possible that an acoustic warning signal sounds, the FIN (END) light blinks and the following alarm codes may be displayed:

- **E10:** problem with the water supply
- **E20:** problem with water draining
- **E40:** door open

Once the problem has been eliminated, press the START/PAUSE button to restart the programme. If after all checks, the problem persists, contact your local AEG/ELECTROLUX Service Force Centre.

Problem	Possible cause	Solution
The machine does not work	The main electrical fuse has blown.	Replace the fuse.
	The door is not properly closed (E40).	Close the door; the click of the lock should be heard.
	The plug is not connected.	Insert the plug.
	The START button has not been pressed.	Press the button.
	The DELAY START option has been selected.	Check the selected delay on the display.

Problem	Possible cause	Solution
The machine does not fill	The water tap is closed (E10) .	Open the water tap.
	The water inlet hose is squashed or kinked (E10) .	Check the whole length of the hose and remove the kink.
	The small filter of the water inlet hose is clogged (E10) .	Clean the filter.
	The door is not properly closed (E40) .	Close the door.
The machine fills then empties immediately	The end of the drain hose is too low.	Place the hose at the right height (see Installation section).
The machine does not empty and/or does not spin	The drain hose is squashed or kinked (E20) .	Check the whole length of the hose and remove the kink.
	The drain pump or the drain hose are clogged (E20) .	Clean the pump or check the hose.
	The RINSE HOLD option (stop with water in drum) has been selected.	Empty out the water by selecting the DRAIN programme.
	The laundry is not evenly distributed inside the drum.	Redistribute the laundry manually in the drum.
There is water on the floor	Too much detergent has been used.	Measure detergent according to the manufacturer's instructions.
	An unsuitable detergent has been used that creates too much foam.	Use a suitable washing machine detergent.
	One of the connectors on the water inlet hose is leaking.	Check that the hose is firmly screwed on at both ends.
	The drain pump has not been properly screwed on after cleaning.	Fully screw the pump into place.
	The cap on the emergency emptying hose has not been replaced after cleaning the pump.	Replace the cap on the emergency emptying hose after cleaning the pump.

Problem	Possible cause	Solution
The machine vibrates or is noisy	The transit bolts have not been removed.	Check that the machine has been unpacked as described in the Installation section.
	The feet have not been adjusted.	Carefully level the machine.
	There is little laundry in the drum.	Correct operation of the machine is not affected.
The door will not open	The programme is still running and the drum is turning.	Wait until the end of the programme before opening the door.
	The water level is above the bottom edge of the door.	Before opening the door, the water must be emptied out.
	The machine is heating the water.	Wait until the end of the heating phase.
Spinning starts late or the machine does not spin	The unbalance detection device that prevents excessive vibration during spinning has cut in.	<p>If the laundry is not evenly distributed inside the drum at the beginning of the spin cycle, the machine detects this and tries to redistribute it more evenly by means of a few drum rotations.</p> <p>Only when the laundry is more evenly distributed will the spin cycle be performed, at a lower speed, if the laundry is not evenly distributed.</p> <p>If, after about 10 minutes, the laundry is still tangled, the machine will not spin. Therefore, if the laundry is still wet at the end of the cycle, it is advisable to redistribute it manually inside the drum and to select the spin programme.</p>

Unsatisfactory washing results

If the laundry looks grey and lime scale is found in the drum

- Too little detergent has been used.
- An unsuitable detergent has been used.
- Stubborn stains have not been treated prior to washing.
- The programme/temperature has not been correctly selected.

If grey stains remain on the laundry

- Laundry stained with ointments, grease or oil has been washed with an insufficient amount of detergent.
- The temperature selected for the wash programme was too low.
- Fabric softener - especially the concentrated type - has come into direct contact with the laundry. Wash these stains immediately and pour fabric softener carefully.

Foam is still visible even after the last rinse

- Modern detergents often produce foam, even in the last rinse. However the laundry has been completely rinsed.

White residue is left on the laundry

- This is due to insoluble components in modern detergents and is therefore not the result of insufficient rinsing. Shake or brush the laundry. In future, it may be better to turn garments inside out before washing them. Check the choice of detergent; try using liquid detergents.

Technical data

Height x Width x Depth	85x60x60 cm
Depth with door opened	101.5 cm
Height adjustment	± 10 mm approx.
Load (depending on programme)	6 kg max.
Use	domestic
Drum speed during washing	max. 55 rpm
Drum speed during spinning	1200/900/600 rpm (L62895) 1000/800/600 rpm (L60895)
Water pressure	0.05 - 0.8 MPa

- CE** This appliance complies with the following EC directives:
- 73/23/EEC of 19.2.1973 "Low voltage directive", including directive 93 / 68 / EEC
 - 89/336/EEC of 3.5.1989 "Electromagnetic Compatibility Directive".

Service

In the section "Something not working?" some problems that can be solved by yourself are listed. Read this section in the event of problems. If you are not able to find a solution, contact the Service centre.

In all cases, explain your problem carefully, in order to facilitate troubleshooting: the engineer will be able to decide whether a service call is necessary.

Take note of the serial number (Ser.No.) and the product number (Prod. No.) indicated on the rating plate.

Ser. No.

Prod. No.

Furthermore, try to specify, as precisely as possible:

- The symptoms of the fault
- When the fault occurs
- The alarm code displayed

When can a service visit be charged during the guarantee period?

- when it should have been possible to solve the problem by yourself, with the help of the troubleshooting chart (see section "Something not working?")
- when the engineer has to come out several times because he has not been given all the relevant information he needs and so, for example, has to fetch spare parts. Repeated trips can be avoided if you prepare your call to the Service centre as described above.

Instructions for installation and electrical connection



Safety instructions for the installer

- This appliance is heavy, care should be taken when moving it.
- When unpacking the appliance, check that it is not damaged. If in doubt, do not use it and contact the retailer.
- All internal packing must be removed before using the appliance. Serious damage may be caused to the machine or adjacent furniture if the protective transit devices are not completely removed. Refer to the relevant paragraph.
- Any electrical work required to install this appliance must be carried out by a qualified electrician.
- Any plumbing work required to install this appliance must be carried

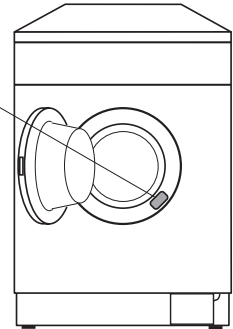
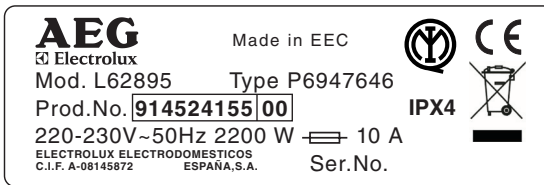

out by a qualified plumber.

- After having installed the machine, check that it is not standing on its electrical supply cable.
- If the appliance is placed on a carpeted floor, ensure that air can circulate freely between the adjustable feet and the floor.
- The installation should comply with local water authority and building regulations requirements.
- Should the appliance power supply cable need to be replaced, this should be carried out by our Service Force Centre.

Installation

Unpacking

- ⚠ All transit bolts and packing must be removed before using the appliance.
- 👉 After removing all the packaging, carefully lay machine on it's back to remove the polystyrene base from the bottom.

- 👉 Remove the power supply cable and the draining hose from the hose holders on the rear of the appliance.
- 👉 With a suitable spanner, supplied with the machine unscrew and remove the central rear bolt **A**. Slide out the relevant plastic spacer.
- 👉 Unscrew and remove the two large rear bolts **B** and the six smaller bolts **C**.
- 👉 Remove the bracket **D**. Tighten up the six smaller bolts **C**.

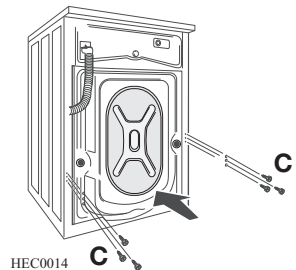
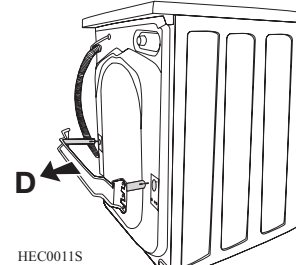
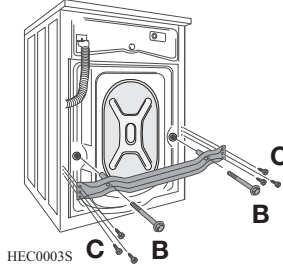
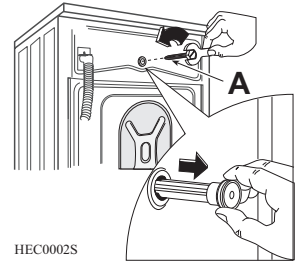
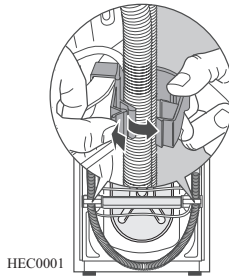
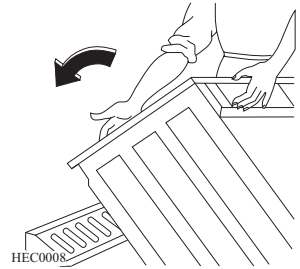

- ☞ Open the porthole, take out the inlet hose from the drum and remove the polystyrene block fitted with the adhesive tape on the door seal.

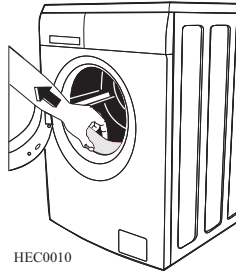

- ☞ Fill the smaller upper hole and the two large ones with the corresponding plastic plug caps supplied in the bag containing the instruction booklet.

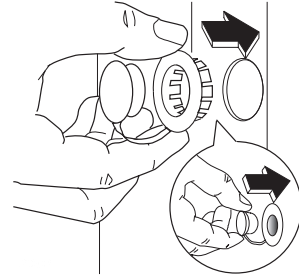
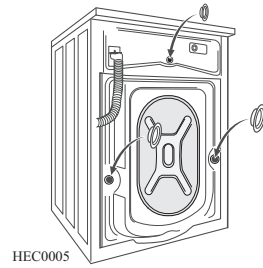

Important!

All the different plug caps are supplied with the appliance in the plastic bag containing the instruction booklet.

Connect the water inlet hose as described under the paragraph "Water inlet".

Positioning

Install the machine on a flat hard floor.

Make sure that air circulation around the machine is not impeded by carpets, rugs etc.

- Before placing it on small tiles, apply a rubber coating.
- Never try to correct any unevenness in the floor by putting pieces of wood, cardboard or similar materials under the machine.
- If it is impossible to avoid positioning the machine next to a gas cooker or coal-burning stove, an insulating panel (85x57 cm) covered with aluminium foil on the side facing the cooker or stove, must be inserted between the two appliances;
- The machine must not be installed in rooms where the temperature can drop below 0.
- The water inlet hose and the drain hose must not be kinked.
- Please ensure that when the appliance is installed, it is easily accessible for the engineer in the event of a breakdown.

Levelling

Carefully level by screwing the adjustable feet in or out. Never place cardboard, wood or similar materials under the machine to compensate for any unevenness in the floor.

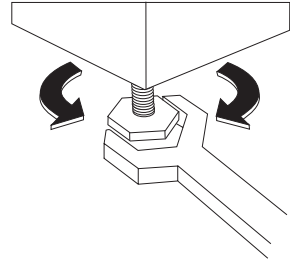

Water inlet

Attention!

- An inlet hose is supplied and can be found inside the machine drum.
- **Do not use the hose from your previous machine to connect to the water supply.**
- **This appliance must be connected to a cold water supply.**

1. Open the porthole and extract the inlet hose.
2. Connect the hose with the angled connection to the machine.

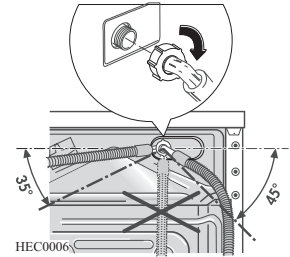

Important!

Do not place the inlet hose downwards. Angle the hose to the left or right depending on the position of your water tap.

3. Set the hose correctly by loosening the ring nut. After positioning the inlet hose, be sure to tighten the ring nut again to prevent leaks.

4. Connect the hose to a tap with a 3/4" thread.

Always use the hose supplied with the appliance.

Installation should comply with local water authority and building regulations' requirements. A minimum water pressure of 0.05 MPa (0.5 bar) is required for safe operation of the appliance.

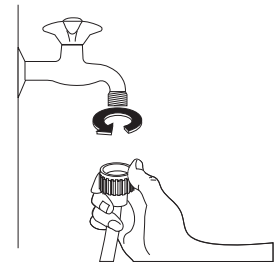

If you cannot make the cold water connection direct from the rising mains, you may be able to operate the appliance from your cold water storage system. There should be a minimum distance of 5.02m (16.5 ft) between the appliance's inlet and the bottom of the water storage tank.

Water drainage

The end of the drain hose can be positioned in three ways:

Hooked over the edge of a sink using the plastic hose guide supplied with the machine. In this case, make sure the end cannot come unhooked when the machine is emptying.

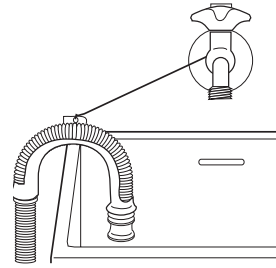

This could be done by tying it to the tap with a piece of string or attaching it to the wall.

In a sink drain pipe branch. This branch must be above the trap so that the bend is at least 60 cm above the ground.

Directly into a drain pipe at a height of not less than 60 cm and not more than 90 cm.

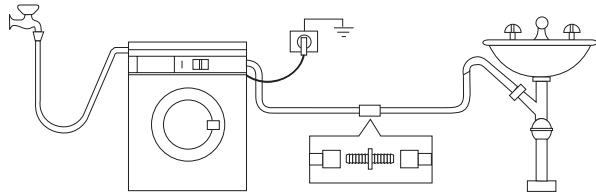

The end of the drain hose must always be **ventilated**, i.e. the inside diameter of the drain pipe must be larger than the outside diameter of the drain hose.

The drain hose must not be kinked.

Electrical connection

This machine is designed to operate on a 220-230 V, single-phase, 50 Hz supply.

Check that your domestic electrical installation can take the maximum load required (2.2 kW), also taking into account any other appliances in use.

Connect the machine to an earthed socket.



The manufacturer does not accept any responsibility for damage or injury through failure to comply with the above safety precaution.

Permanent connection

In the case of a permanent connection it is necessary that you install a double pole switch between the appliance and the electricity supply (mains), with a minimum gap of 3 mm between the switch contacts and of a type suitable for the required load in compliance with the current electrical regulations.

The switch must not break the yellow and green earth cable at any point.

This operation must be performed by a qualified electrician.

Important: The power supply cable must be easily accessible after installing the machine.

AEG Hausgeräte GmbH
Postfach 1036
D-90327 Nürnberg

<http://www.aeg.hausgeraete.de>

© Copyright by AEG/ELECTROLUX

132974550-01-0107

Salvo modificaciones
Subject to change without notice



From the Electrolux Group. The world's No. 1 choice.

The Electrolux Group is the world's largest producer of powered appliances for kitchen, cleaning and outdoor use. More than 55 million Electrolux Group products (such as refrigerators, cookers, washing machines, vacuum cleaners, chain saws and lawn mowers) are sold each year to a value of approx. USD 14 billion in more than 150 countries around the world.