



HPA700F

Dispositivo sonoro di allarme incendio da esterno autoalimentato

Dispositif sonore d'alarme incendie extérieure auto-alimentée

Self-powered Outdoor sound device for fire alarm system.

Dispositivo sonoro de alarma incendios autoalimentado para exterior

Manuale di installazione

Notice d'installation

Installation Manual

Manual de instalación



ELKRON

SOMMARIO

SOMMARIO	2
1.0 CARATTERISTICHE GENERALI	2
2.0 INSTALLAZIONE	3
3.0 CONNESSIONI	4
4.0 COLLEGAMENTO CON CENTRALI ELKRON	5
4.1 Collegamento con sirena singola.....	5
4.2 Collegamento con sirene/campane.....	6
5.0 CARATTERISTICHE TECNICHE	7

1.0 CARATTERISTICHE GENERALI

Prodotto da costruzione conforme al regolamento CPR.

Dispositivo sonoro di allarme incendio da esterno autoalimentato.

Dotato di serie di un modulo convertitore 24/12Vdc per consentire il funzionamento in **abbinamento a tutte le centrali di rilevazione incendio** disponibili. Va equipaggiato con una batteria interna 12V - 1,9 Ah.

Per l'utilizzo con le centrali di rilevazione incendio ELKRON, essendo equipaggiate di una linea bilanciata di controllo dell'integrità delle connessioni, raccomandiamo di attenersi agli esempi di collegamento di seguito riportati.



ELKRON è un marchio commerciale di URMET S.p.A.
Via Bologna, 188/C - 10154 Torino (TO) – Italy

12

0051-CPD-0386

DoP n. 0051-CPR-0386

EN54-3:2001 + A1:2002 + A2:2006

Dispositivo sonoro di allarme incendio

Tipo B per uso esterno

HPA700F

Dati tecnici: vedi manuale LBT80722
e dossier tecnico di progetto presso costruttore.

Principio di funzionamento

Il dispositivo sonoro si attiva con la presenza di una tensione di 24V sul morsetto "+ LINE IN".

 **La presenza del segnale di comando provoca l'attivazione della sirena con tempo di suonata illimitato (non temporizzato) come da normativa EN54-3 sulla rilevazione incendi.**

2.0 INSTALLAZIONE

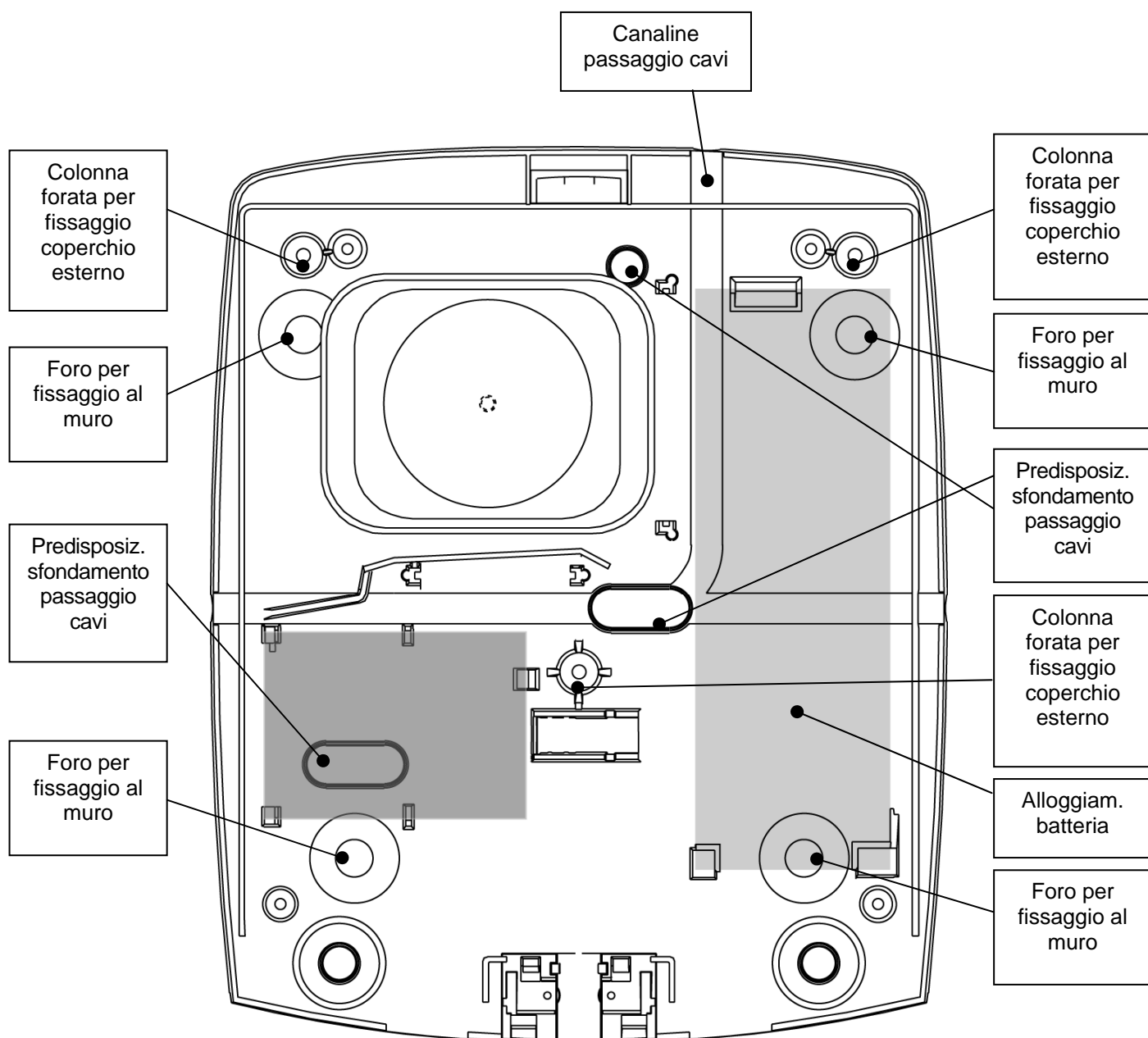

- Aprire la sirena svitando le tre viti frontali di chiusura;
- Fratturare una delle predisposizioni a sfondamento per il passaggio dei cavi e fissare la sirena al muro tramite i tasselli forniti utilizzando i fori previsti;
- Effettuare i collegamenti;
- Inserire la batteria nell'alloggiamento e collegare i faston: filo rosso al positivo, filo nero al negativo;
- Chiudere e fissare con le apposite viti il coperchio esterno.

3.0 CONNESSIONI

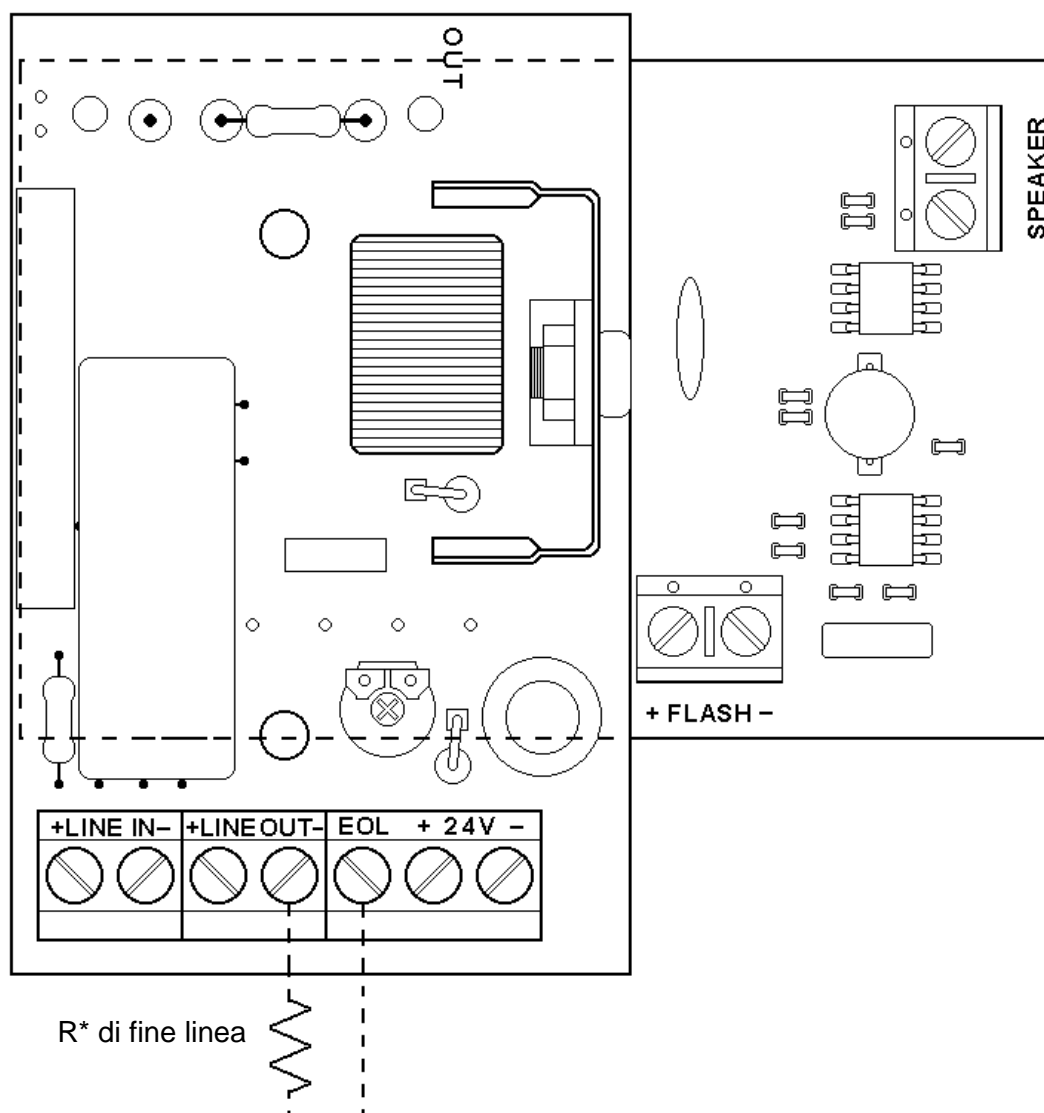

LINE IN +	Morsetto di appoggio ingresso positivo linea di allarme proveniente dalla centrale di rilevazione incendio o da altre sirene/campane in cascata.
LINE IN -	Morsetto di appoggio ingresso negativo linea di allarme proveniente dalla centrale di rilevazione incendio o da altre sirene/campane in cascata.
LINE OUT +	Uscita positivo linea di allarme per pilotare eventuali altri dispositivi connessi in cascata.
LINE OUT -	Uscita negativo linea di allarme per pilotare eventuali altri dispositivi connessi in cascata.
EOL	End Of Line. Terminazione per la resistenza di fine linea, da collegare al negativo di allarme proveniente dalla centrale di rilevazione incendio o da altre sirene/campane solo sull'ultimo dispositivo (vedi esempio).
+ 24V -	Ingresso alimentazione dispositivo (da prelevare in centrale). Attenzione: la mancanza dell'alimentazione determina lo sgancio del relè con relativa apertura della resistenza R di fine linea.
+ FLASH -	Collegamento lampada flash a filamento.
SPEAKER	Collegamento tromba.

R*: Il valore della resistenza deve essere quello indicato nel manuale tecnico della centrale di rilevazione incendio utilizzata.

4.0 COLLEGAMENTO CON CENTRALI ELKRON

4.1 Collegamento con sirena singola

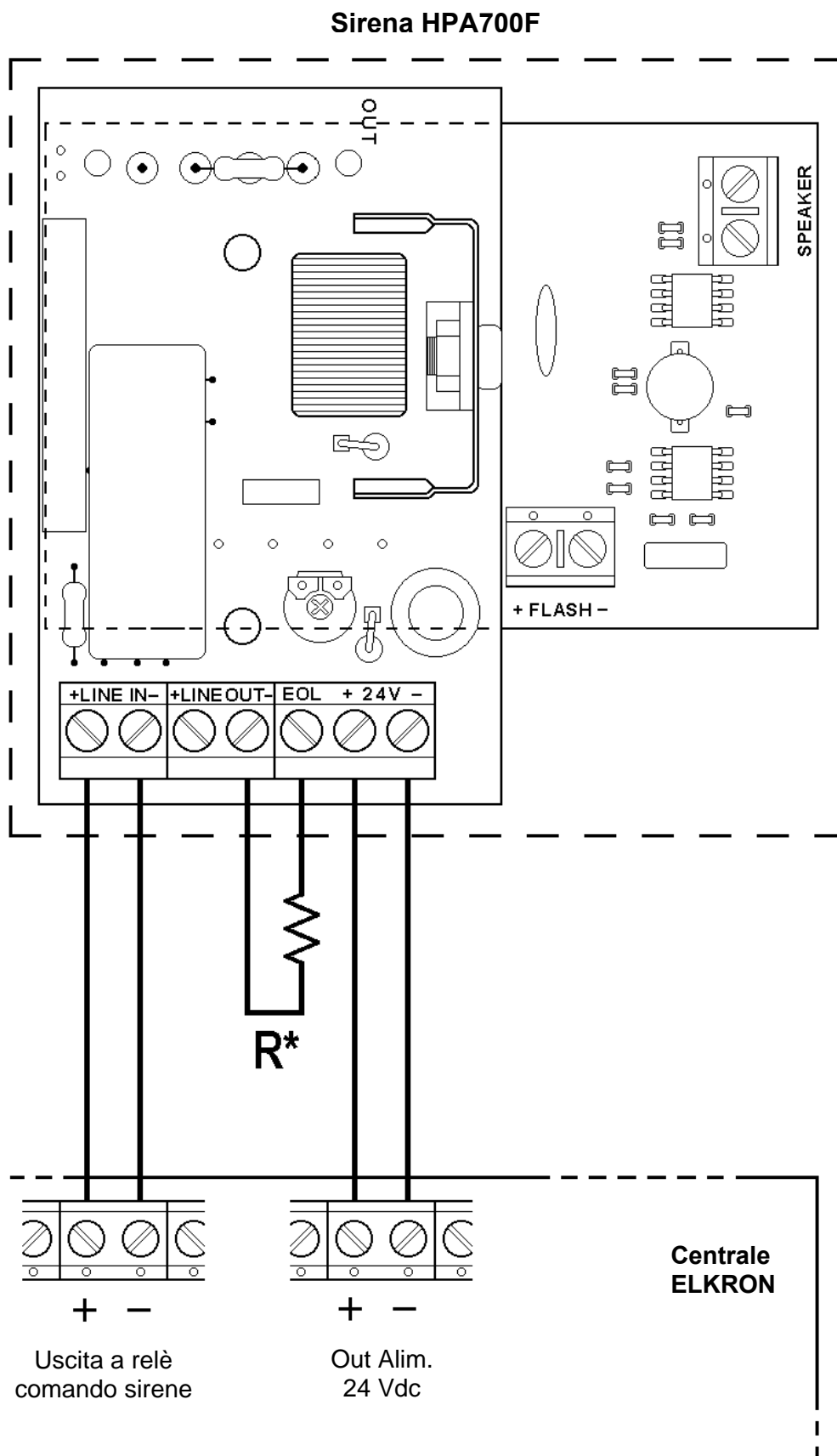

4.2 Collegamento con sirene/campane

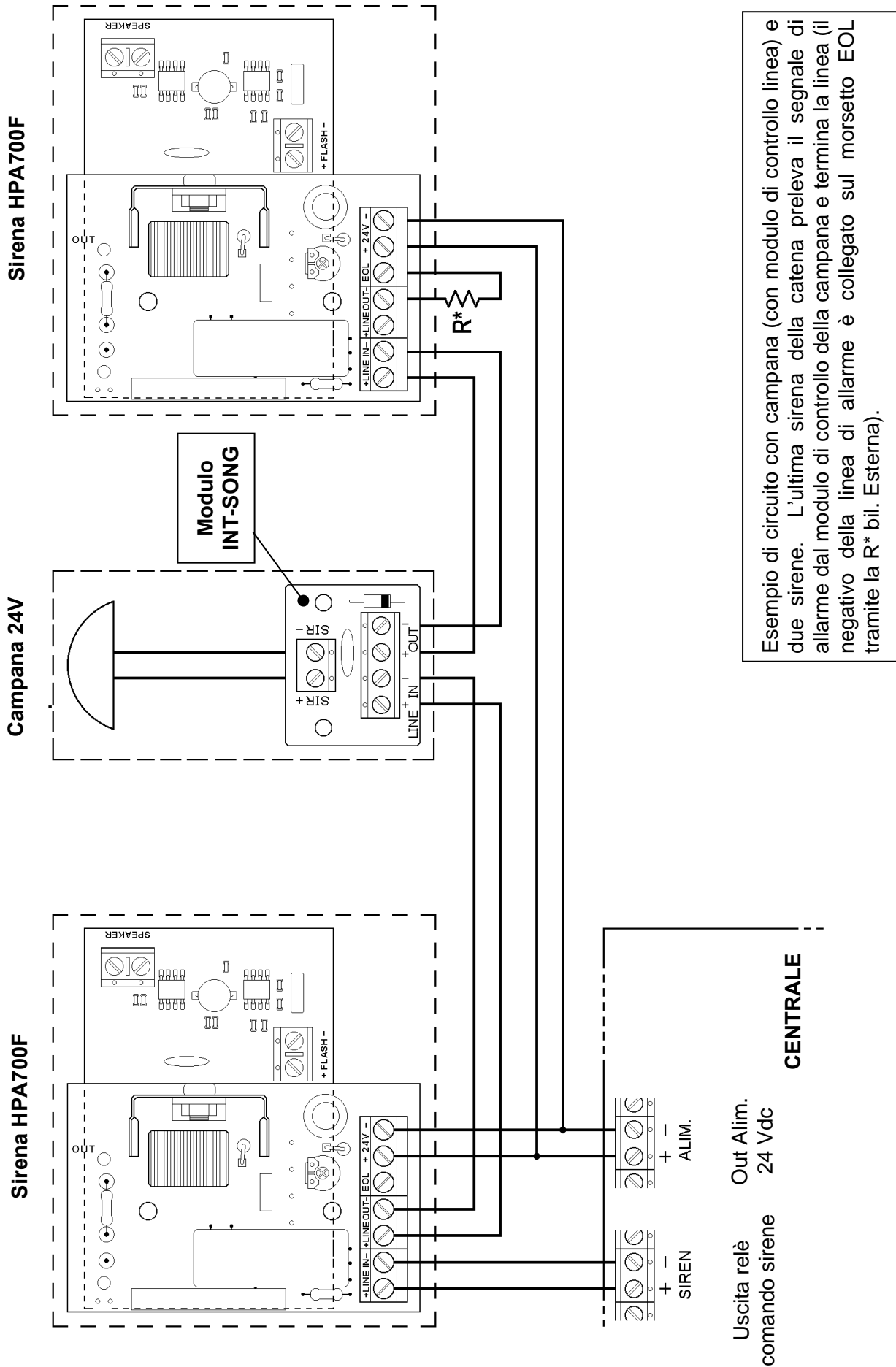

5.0 CARATTERISTICHE TECNICHE

Blocco suonata alla prima alimentazione	
Tensione nominale di alimentazione	24 Vdc
Tensione minima di funzionamento:	18 Vdc
Tensione massima di funzionamento:	30 Vdc
Assorbimento a riposo:	24 mA tipici
Assorbimento max di ricarica batteria:	650 mA
Assorbimento in allarme:	1A alla tensione nominale
Potenza max in allarme:	24W
Potenza lampada ad incandescenza:	10W
Grado di protezione involucro certificato (EN 60529):	IP33C
Grado di protezione involucro dichiarato dal costruttore:	IP43
Grado di resistenza meccanica IK dichiarato dal costruttore:	IK08
Frequenza di funzionamento:	2400 ÷ 2800 Hz
Accumulatore allocabile:	12V 1.9Ah, 12V 2Ah, 12V 2.1Ah
Temperatura di funzionamento certificata:	-25°C ÷ +70°C
Portata contatti relè R controllo fine linea	6 A @ 24 Vdc
Dimensioni (l x h x p):	212 x 270 x 78 mm

SPETTRO EMISSIONE ACUSTICA AD 1 METRO

HPA700F – PIANO ORIZZONTALE [dB(A)] a 1m.						
Angolo	15°	45°	75°	105°	135°	165°
Con batteria	100	105	109	110	105	101
Senza batteria	100	105	109	110	104	101

HPA700F – PIANO VERTICALE [dB(A)] a 1m.						
Angolo	15°	45°	75°	105°	135°	165°
Con batteria	100	106	108	108	109	102
Senza batteria	100	105	107	109	108	102

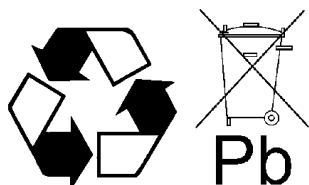

IMPORTANTE: Le batterie sono considerate rifiuti pericolosi (C.E.R. 160601) e pertanto vanno consegnate presso smaltitori autorizzati.

TABLES DES MATIERES

TABLES DES MATIERES	8
1.0 CARACTERISTIQUES GENERALES	8
2.0 INSTALLATION	9
3.0 RACCORDEMENTS	10
4.0 RACCORDEMENT AVEC CENTRALES ELKRON	11
4.1 Raccordement avec une seule sirène.....	11
4.2 Raccordement avec sirènes/cloches.....	12
5.0 CARACTERISTIQUES TECHNIQUES	13
NOTE	26

1.0 CARACTERISTIQUES GENERALES

Produit de construction conforme au règlement CPR.

Dispositif sonore d'alarme incendie extérieure auto-alimentée.

Equipé de série d'une carte convertisseur 24/12Vdc pour permettre le fonctionnement en association à toutes les centrales de relèvement incendie disponibles. Il doit être muni d'une batterie interne 12V - 1,9 Ah.

Pour l'utilisation avec les centrales de relèvement incendie ELKRON, étant donné qu'elle sont équipées d'une ligne équilibrée de contrôle de l'intégrité des connexions, nous suggérons de suivre l'exemple de raccordement décrit dans les pages suivantes.

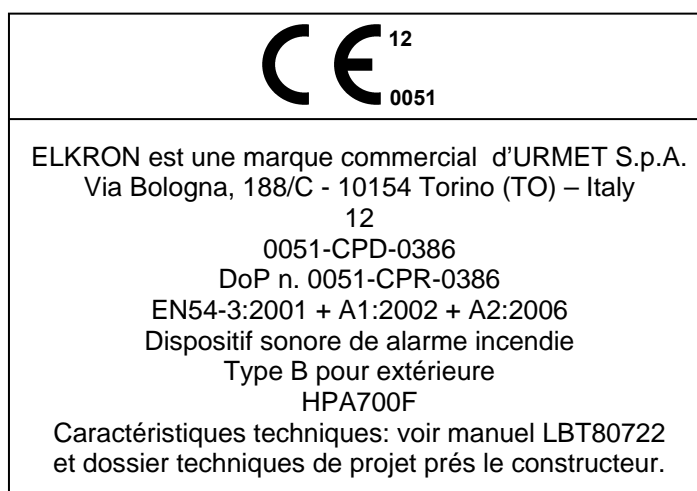

Fonctionnement

Le dispositif sonore se active avec la présence d'une tension de 24V sur la borne "+ LINE IN".

 **La présence du signal de commande entraîne l'activation de la sirène dont la durée de la sonnerie est illimitée (non temporisée) conformément à la norme EN54-3 sur la détection d'incendie.**

2.0 INSTALLATION

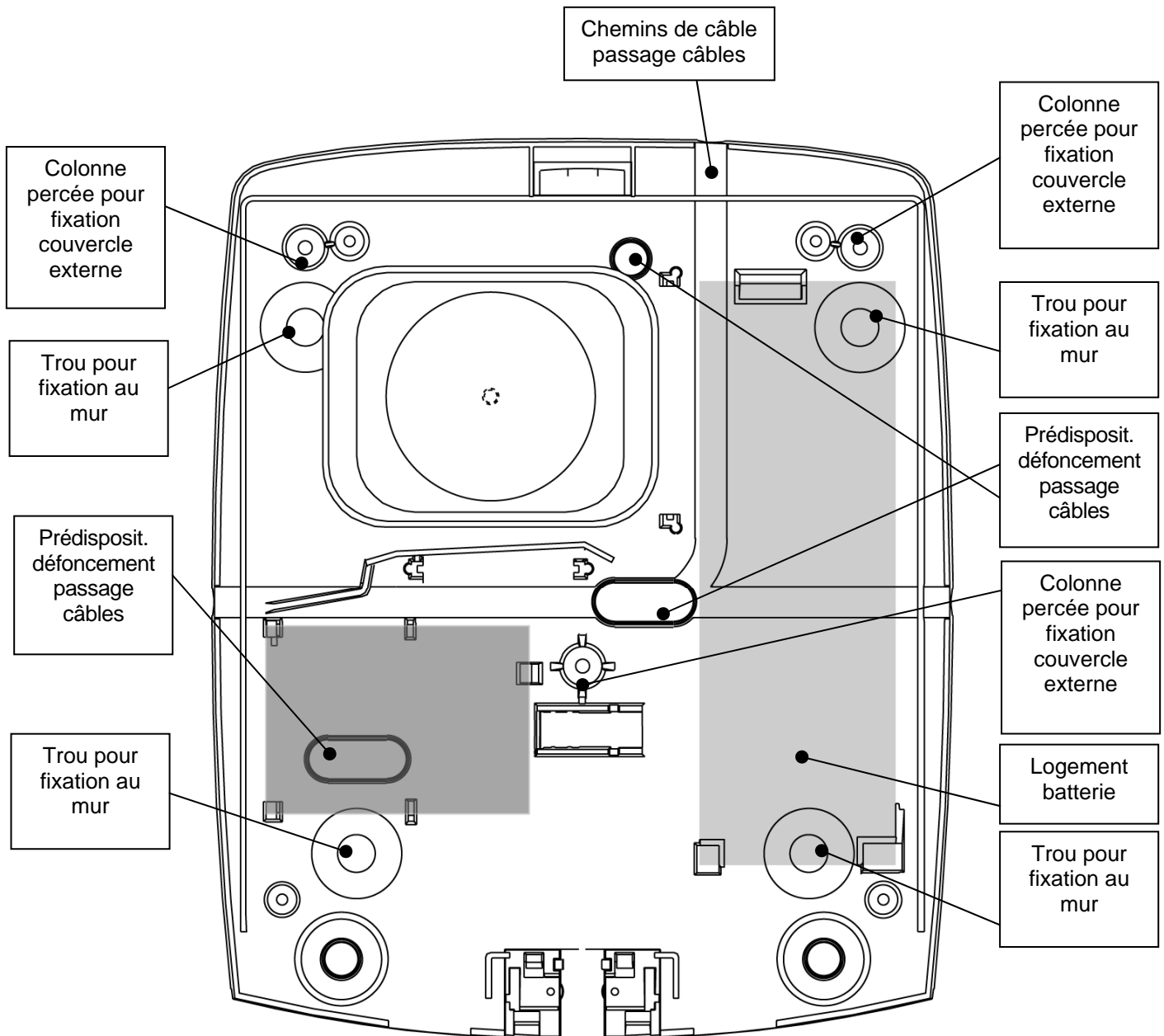

- Ouvrir la sirène en dévissant les trois vis sur le capot;
- Fracturer une des prédispositions à défoncement pour le passage des câbles et fixer la sirène au mur au moyen des tasseaux fournis utilisant les trous prévus;
- Effectuer les raccordements;
- Insérer la batterie dans le logement et raccorder les faston: fil rouge au positif, fil noir au négatif;
- Fermer et fixer le capot avec les trois vis.

3.0 RACCORDEMENTS

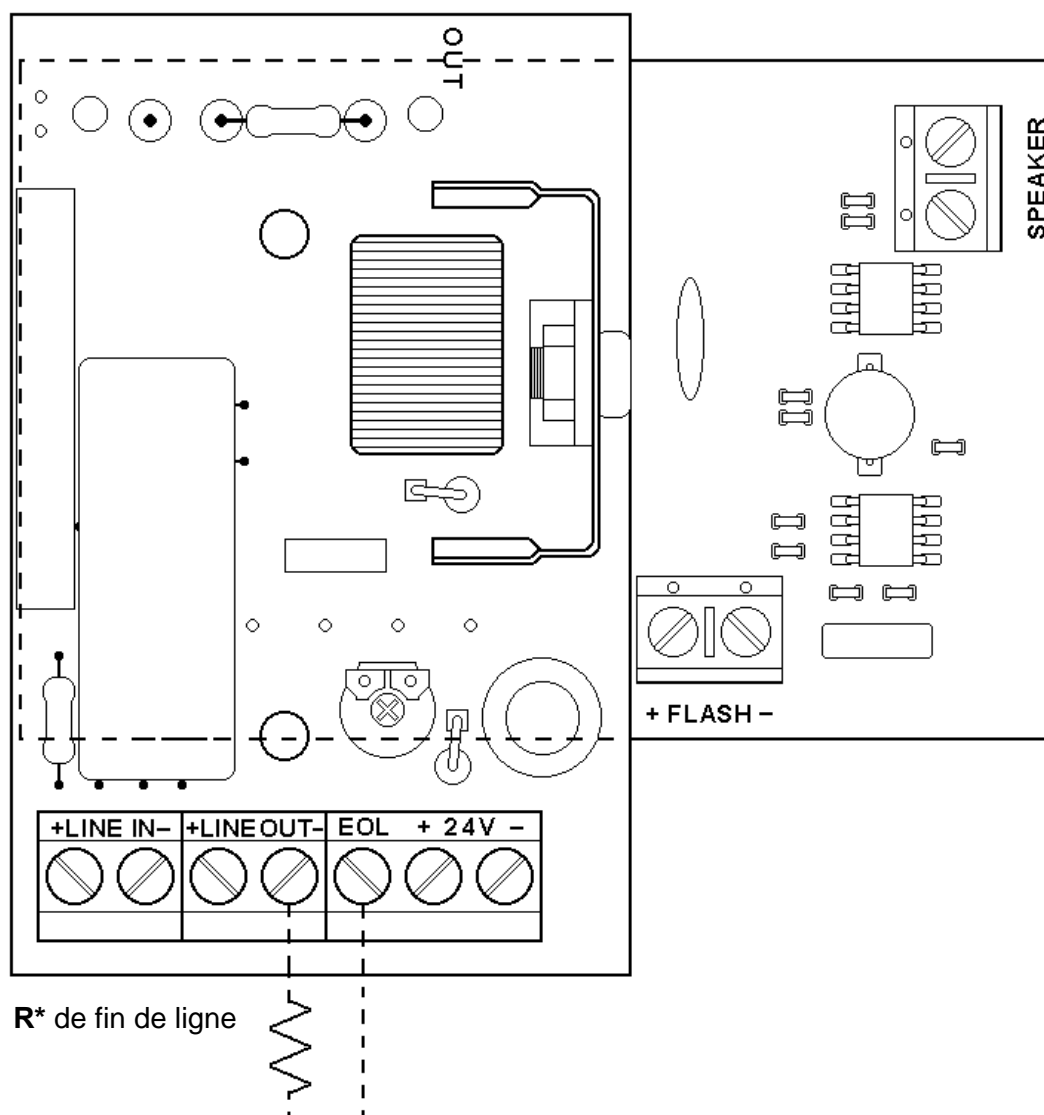

LINE IN +	Borne de service entrée positive ligne d'alarme provenant de la centrale de relèvement incendie ou d'autres sirènes/cloches en cascade.
LINE IN -	Borne de service entrée négative ligne d'alarme provenant de la centrale de relèvement incendie ou d'autres sirènes/cloches en cascade.
LINE OUT +	Sortie positive ligne d'alarme pour piloter d'autres dispositifs connectés en cascade.
LINE OUT -	Sortie négative ligne d'alarme pour piloter d'autres dispositifs connectés en cascade
EOL	End Of Line. Terminaison de fin de ligne, à raccorder au négatif d'alarme provenant de la centrale de relèvement incendie ou d'autres sirènes/cloches seulement sur le dernier dispositif (voir exemple).
+ 24V -	Entrée alimentation dispositif (à partir de la centrale). Attention: l'absence de l'alimentation donne lieu au déclenchement du relais avec ouverture de la résistance R de fin de ligne.
+ FLASH -	Raccordement lampe flash à filament.
SPEAKER	Raccordement haut-parleur.

R*: Le valeur de la résistance doit être celui indique dans la notice technique de la centrale de relèvement incendie utilisée.

4.0 RACCORDEMENT AVEC CENTRALES ELKRON

4.1 Raccordement avec une seule sirène

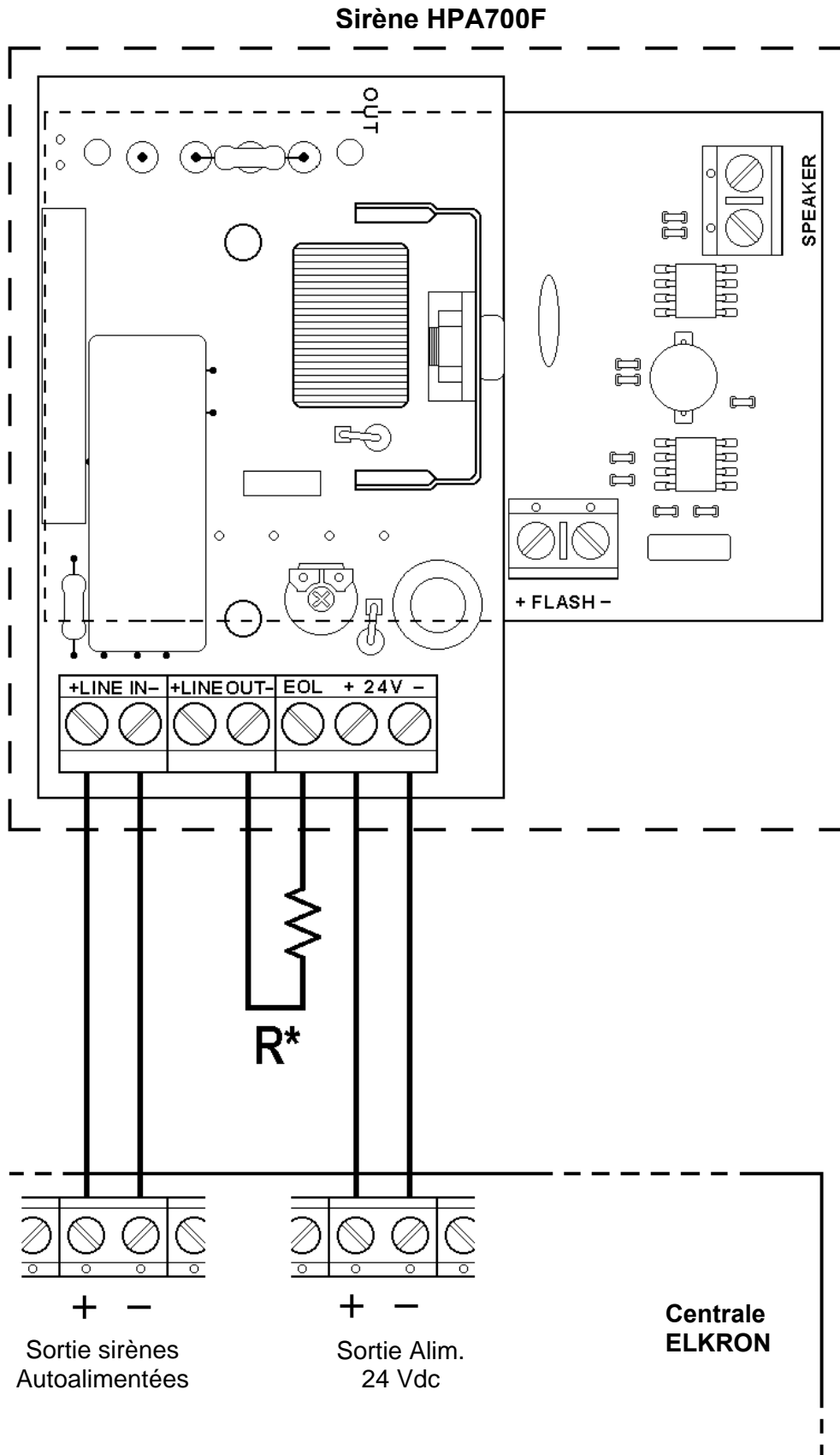

4.2 Raccordement avec sirènes/cloches

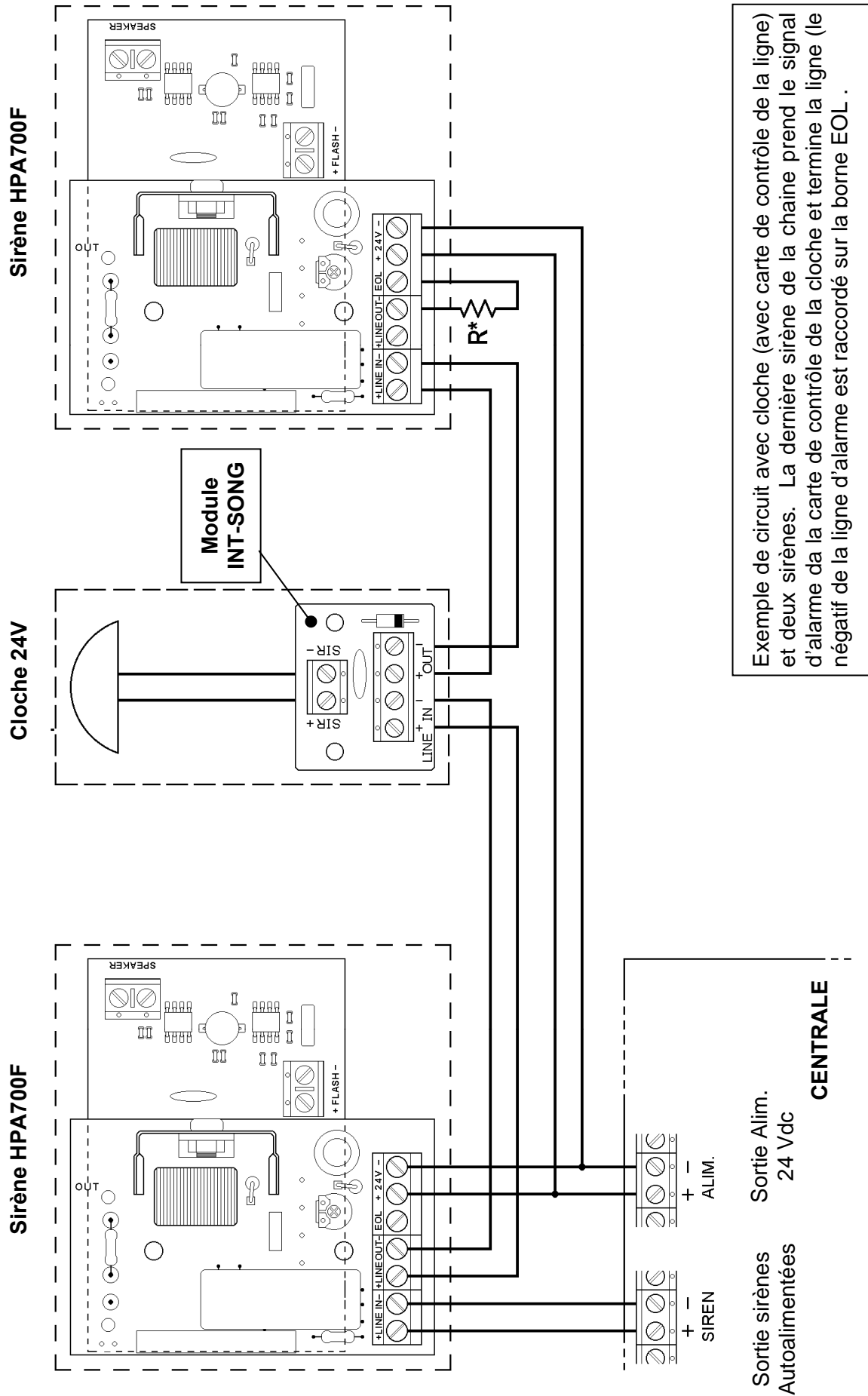

5.0 CARACTERISTIQUES TECHNIQUES

Blocage sonnerie à la première mise sous tension	
Tension nominale d'alimentation	24 Vdc
Tension minimum de fonctionnement	18 Vdc
Tension maximum de fonctionnement	30 Vdc
Consommation au repos	24 mA typiques
Consommation max de recharge de la batterie	650 mA
Consommation en alarme	1A à la tension nominale
Puissance max en alarme	24W
Puissance de la lampe à incandescence	10W
Degré de protection boîtier certifié (EN 60529)	IP33C
Degré de protection boîtier déclaré par le fabricant	IP43
Degré de résistance mécanique IK déclaré par le fabricant	IK08
Fréquence de fonctionnement	2400÷2800 Hz
Accumulateur à loger	12V 1.9Ah, 12V 2Ah, 12V 2.1Ah
Température de fonctionnement certifiée	-25 °C ÷ +70 °C
Contacts relais R de contrôle fin de ligne	6 A @ 24 Vdc
Dimensions (l x h x p)	212 x 270 x 78 mm

SPECTRE D'EMISSION ACUSTIQUE A 1 METRE

HPA700F – PLAN HORIZONTAL [dB(A)] à 1m.						
Angle	15°	45°	75°	105°	135°	165°
Avec batterie	100	105	109	110	105	101
Sans batterie	100	105	109	110	104	101

HPA700F – PLAN VERTICAL [dB(A)] à 1m.						
Angle	15°	45°	75°	105°	135°	165°
Avec batterie	100	106	108	108	109	102
Sans batterie	100	105	107	109	108	102

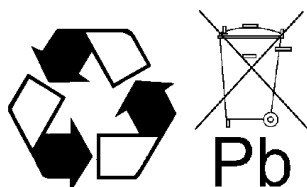

IMPORTANT: Les batteries sont considérées des déchets dangereux (C.E.D. 160601) et par conséquent elles doivent être traitées par des services autorisés.

LIST OF CONTENTS

LIST OF CONTENTS	14
1.0 GENERAL CHARACTERISTICS	14
2.0 INSTALLATION	15
3.0 CONNECTIONS	16
4.0 CONNECTION TO CONTROL PANELS ELKRON	17
4.1 Connection to single siren.....	17
4.2 Connection to sirens/bells.....	18
5.0 TECHNICAL CHARACTERISTICS	19
NOTE	26

1.0 GENERAL CHARACTERISTICS

Manufacture product complying with **CPR regulation**.

Self-powered Outdoor sound device for fire alarm system.

Provided with standard 24/12Vdc converter module to allow operation **coupled to all** available **fire detection control panels**. To be equipped with 12V – 1.9 Ah internal battery.

For use with ELKRON fire detection control panels, because they are equipped with a balanced line to control connection integrity, we recommend to comply with below shown connection examples.

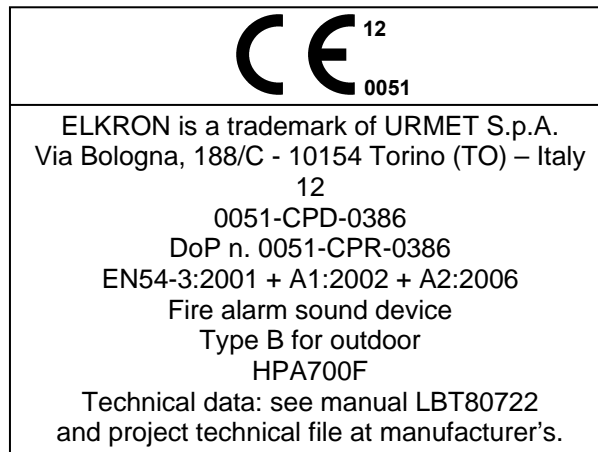

Operation principle

The sound device rings for the presence of a voltage of 24V on "+ LINE IN" terminal block.

 **The presence of the control signal the siren to start with unlimited (not timed) ring time as from EN54-3 regulation on fire detection.**

2.0 INSTALLATION

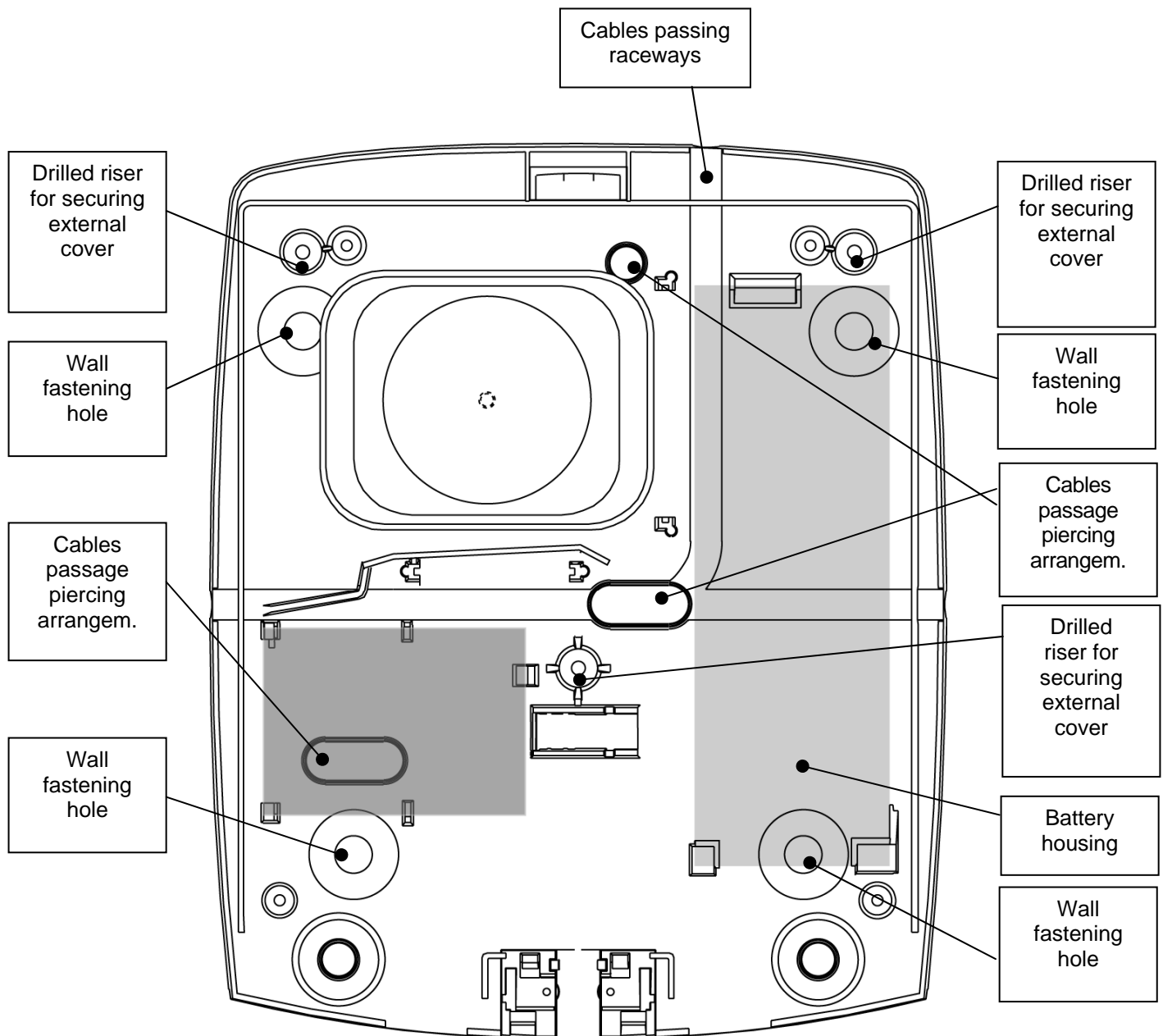

- Open the siren by unscrewing the three front closing screws;
- Break one of breaking down arrangements for cable passage and fix the siren to the wall through provided blocks by using holes provided for;
- Make connections;
- Enter the battery into the housing and connect faston connectors: red wire to positive pole, black wire to negative pole;
- Close and fix outer cover with special screws.

3.0 CONNECTIONS

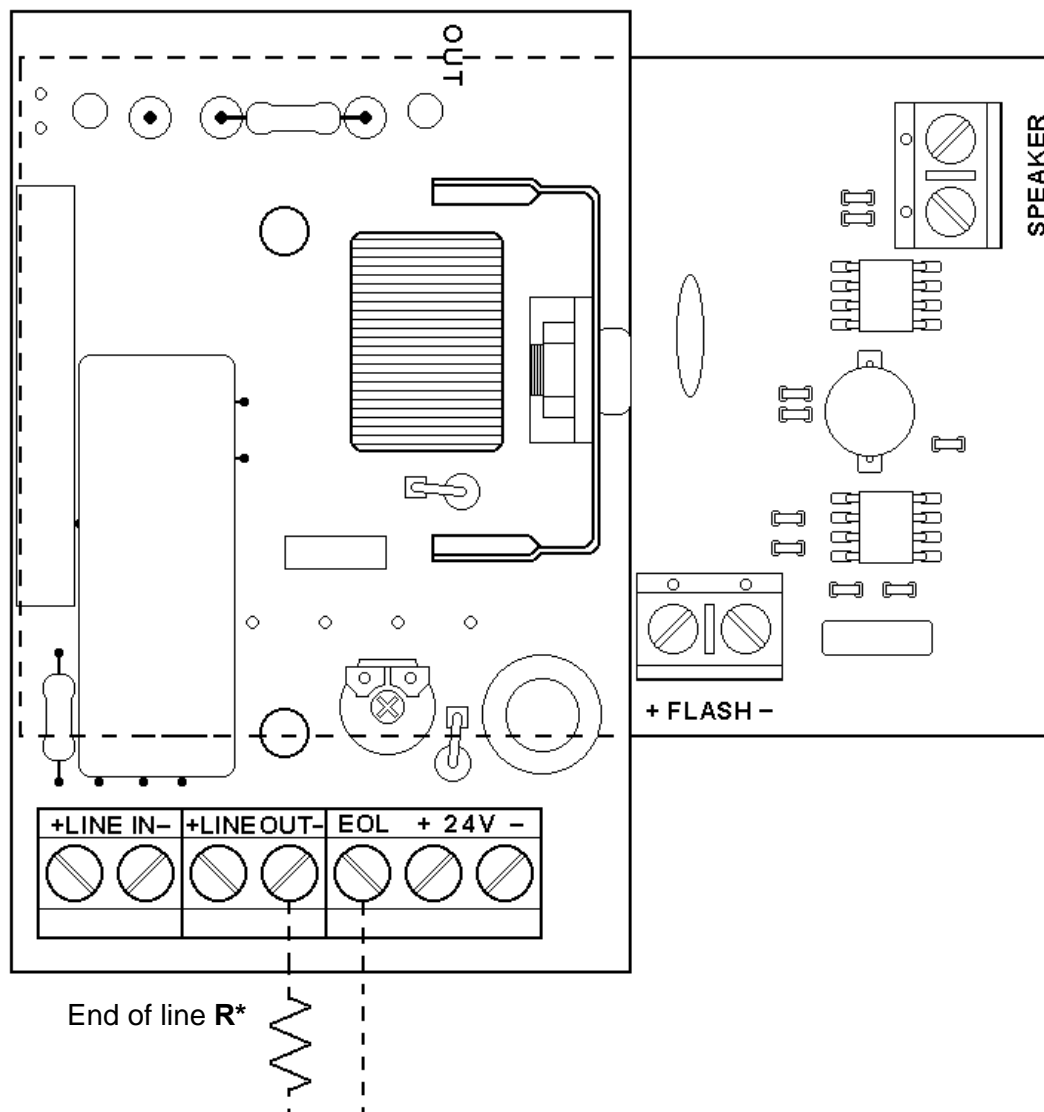

LINE IN +	Positive input rest pin for alarm line from either fire detection control panel or other cascaded sirens/bells.
LINE IN -	Negative input rest pin for alarm line from either fire detection control panel or other cascaded sirens/bells.
LINE OUT +	Positive output for alarm line to drive any other cascaded devices.
LINE OUT -	Negative output for alarm line to drive any other cascaded devices.
EOL	End Of Line. Termination for end of line resistance, to be connected to alarm negative pole from either fire detection control panel or other sirens/bells just on last device (see example).
+ 24V -	Device power supply input (to be taken out of control panel). Caution: lack of power supply causes the relay to break loose with consequent opening of end of line resistance R.
+ FLASH -	Filament flash-lamp connection.
SPEAKER	Horn connection.

R*: Resistance value must be as indicated in used fire control panel technical manual.

4.0 CONNECTION TO CONTROL PANELS ELKRON

4.1 Connection to single siren

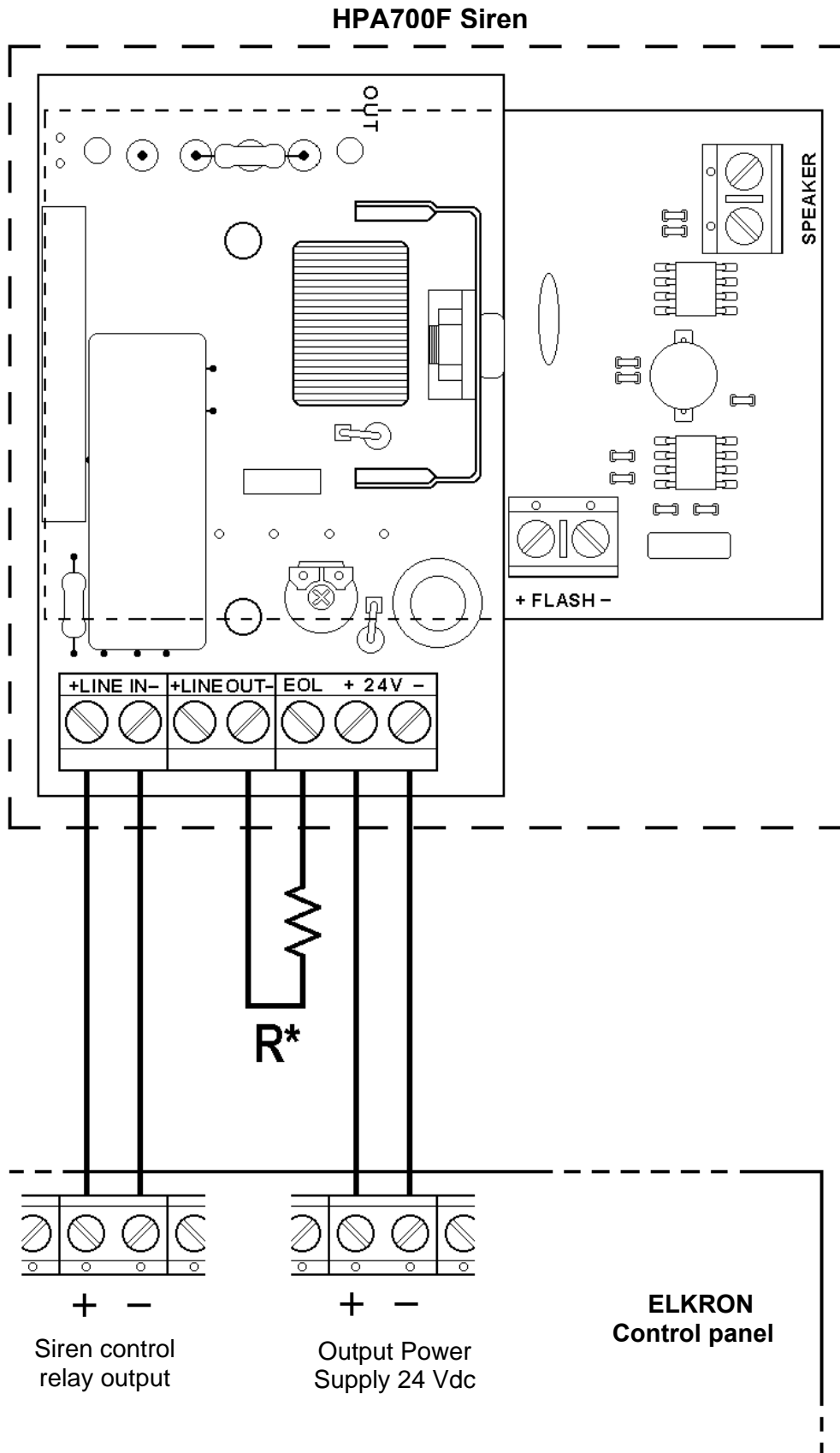

4.2 Connection to sirens/bells

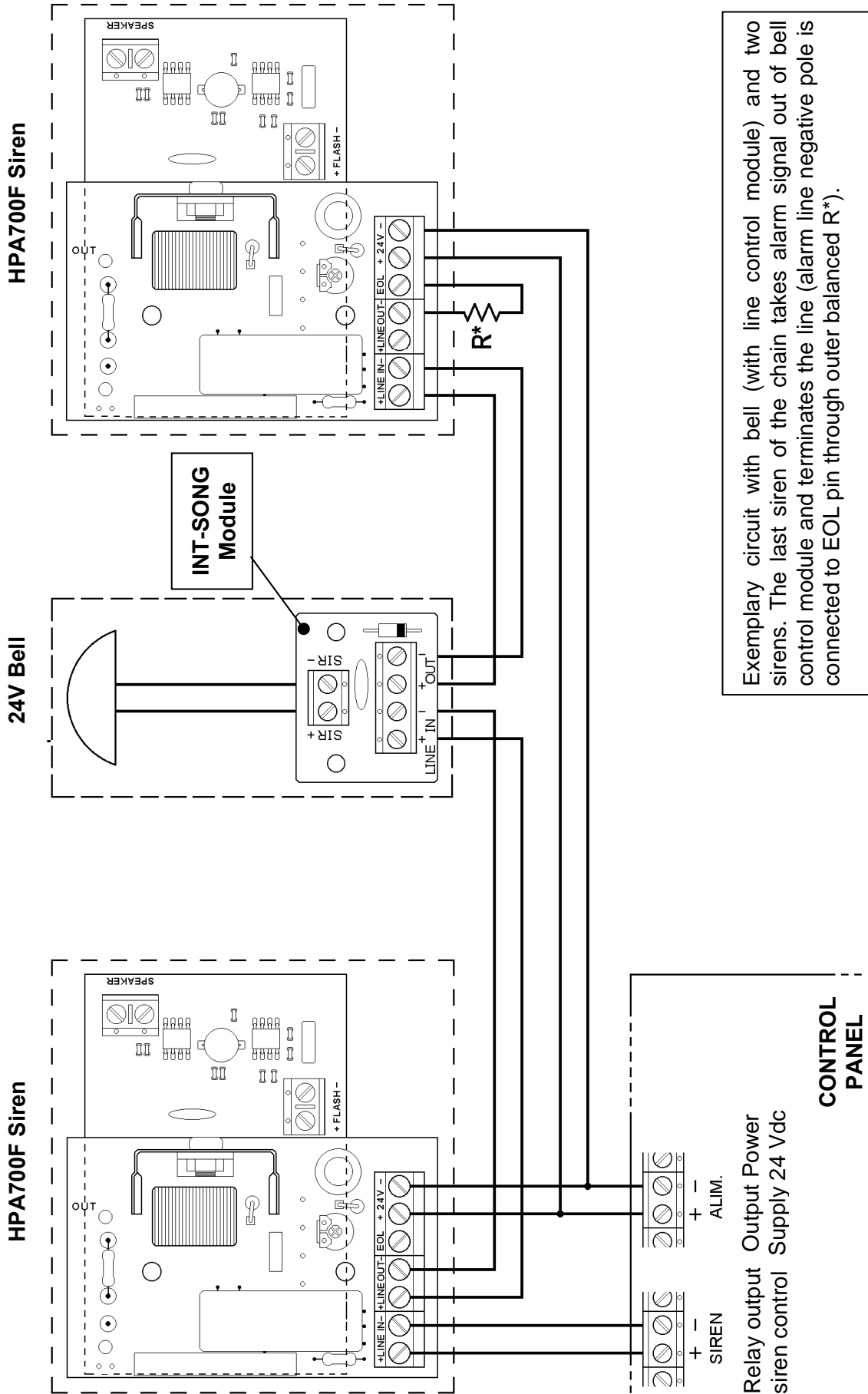

Exemplary circuit with bell (with line control module) and two sirens. The last siren of the chain takes alarm signal out of bell control module and terminates the line (alarm line negative pole is connected to EOL pin through outer balanced R*).

5.0 TECHNICAL CHARACTERISTICS

Locking ringing at first power supply	
Power supply nominal voltage	24 Vdc
Operation minimum voltage:	18 Vdc
Operation maximum voltage:	30 Vdc
Absorption at rest:	24 mA typical
Battery recharge max absorption:	650 mA
Absorption in alarm conditions:	1A at nominal voltage
Power max in alarm conditions:	24W
Incandescent lamp power:	10W
Certified (EN 60529) shell protection grade:	IP33C
Shell protection grade as declared by manufacturer:	IP43
IK mechanical resistance grade as declared by manufacturer:	IK08
Operating frequency:	2400÷2800 Hz
Allocable battery:	12V 1.9Ah, 12V 2Ah, 12V 2.1Ah
Certified operation temperature:	-25 °C ÷ +70°C
End of line control R relay contact capacity	6 A @ 24 Vdc
Dimensions (w x h x d):	212 x 270 x 78 mm

ACOUSTIC EMISSION SPECTRUM AT 1 METRE

HPA700F – HORIZONTAL PLAN [dB(A)] at 1m.						
Angle	15°	45°	75°	105°	135°	165°
With battery	100	105	109	110	105	101
Without battery	100	105	109	110	104	101

HPA700F – VERTICAL PLAN [dB(A)] at 1m.						
Angle	15°	45°	75°	105°	135°	165°
With battery	100	106	108	108	109	102
Without battery	100	105	107	109	108	102

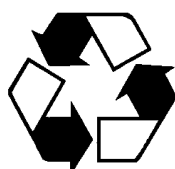

IMPORTANT: Batteries must be deemed dangerous wastes (E.W.C. 160601) and therefore they must be delivered to authorised disposal operators.

SOMMARIO

SOMMARIO	20
1.0 CARACTERÍSTICAS GENERALES	20
2.0 INSTALACIÓN	21
3.0 CONEXIONES	22
4.0 CONEXIÓN CON CENTRALES ELKRON	23
4.1 Conexión con una sola sirena	23
4.2 Conexión con sirenas/campanas	24
5.0 CARACTERÍSTICAS TÉCNICAS	25
NOTE	26

1.0 CARACTERÍSTICAS GENERALES

Producto fabricado conforme a reglamento CPR.

Dispositivo sonoro de alarma incendios autoalimentado para exterior.

Dotado de serie con un módulo conversor 24/12 Vdc, para funcionar **combinado con todas las centrales de detección de incendio** disponibles. Está equipado con una batería interior 12V - 1,9 Ah.

Para el uso con las centrales de detección de incendio ELKRON, que están equipadas con una línea equilibrada que controla la integridad de las conexiones, se recomienda atenerse a los ejemplos de conexión que se indican a continuación.



ELKRON es una marca registrada de URMET S.p.A 10154 Torino (TO) – ITALY 12 0051-CPD-0386 DoP n. 0051-CPR-0386 EN54-3:2001 + A1:2002 + A2:2006 Dispositivo sonoro de alarma de incendio Tipo B para exterior HPA700F Datos técnicos: véase manual LBT80722 e informe técnico de diseño en el establecimiento del fabricante.

Principio de funcionamiento

El dispositivo sonoro suena por la presencia de una tensión de 24V en el borne "+ LINE IN".

 **En la presencia de la señal de control, la sirena se arma activando el sonido durante un tiempo ilimitado (no temporizado), de acuerdo con la normativa EN54-3 sobre detección de incendios.**

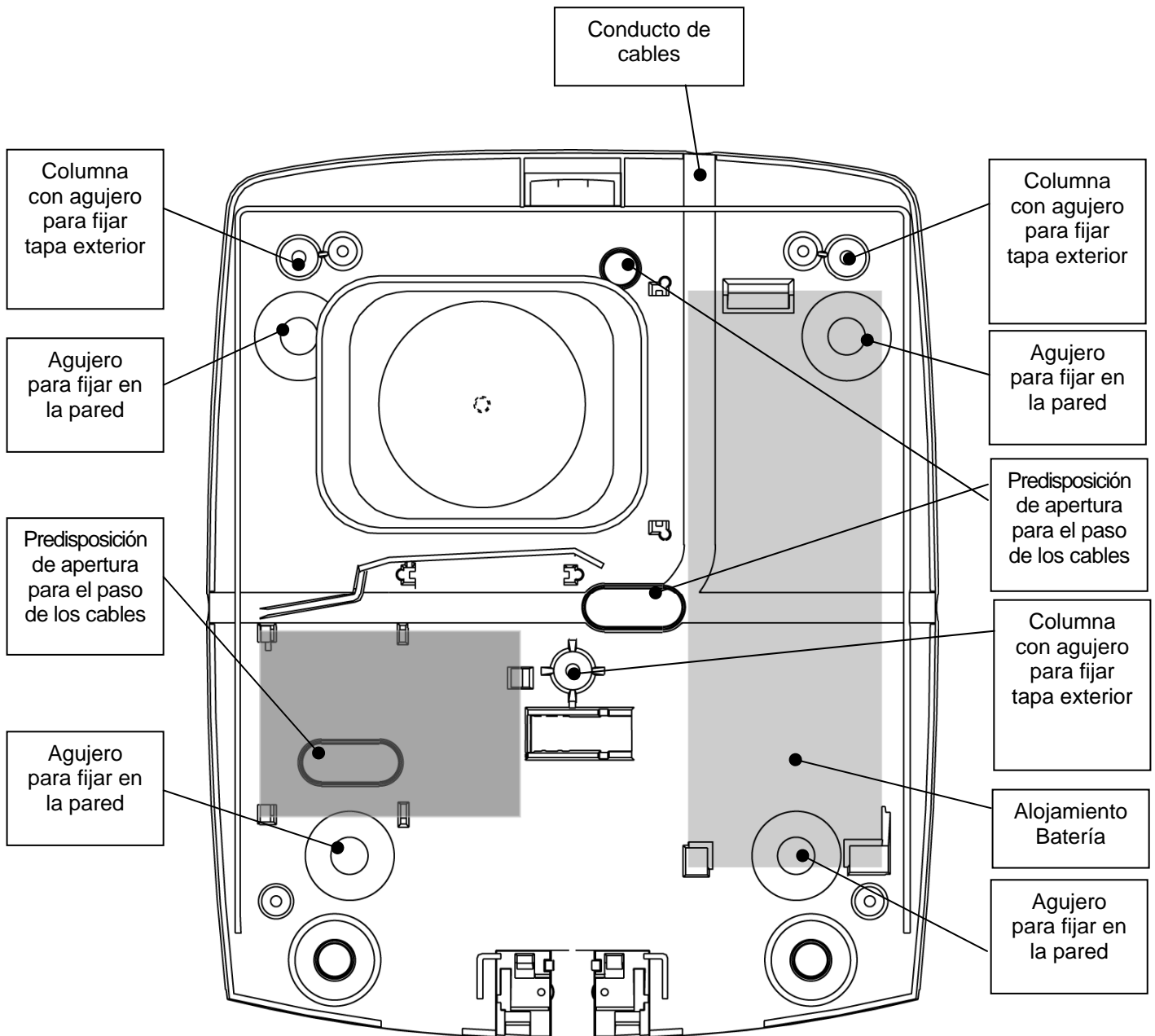
2.0 INSTALACIÓN



- Abrir la sirena desenroscando los tres tornillos frontales de cierre;
- Romper una de las predisposiciones de apertura para el paso de los cables y fijar la sirena en la pared con los tacos suministrados, utilizando los agujeros previstos;
- Efectuar las conexiones;
- Introducir la batería en el alojamiento y conectar los terminales: cable rojo al positivo, cable negro al negativo;
- Cerrar y fijar con los tornillos la tapa exterior.

4.0 CONEXIÓN CON CENTRALES ELKRON

4.1 Conexión con una sola sirena

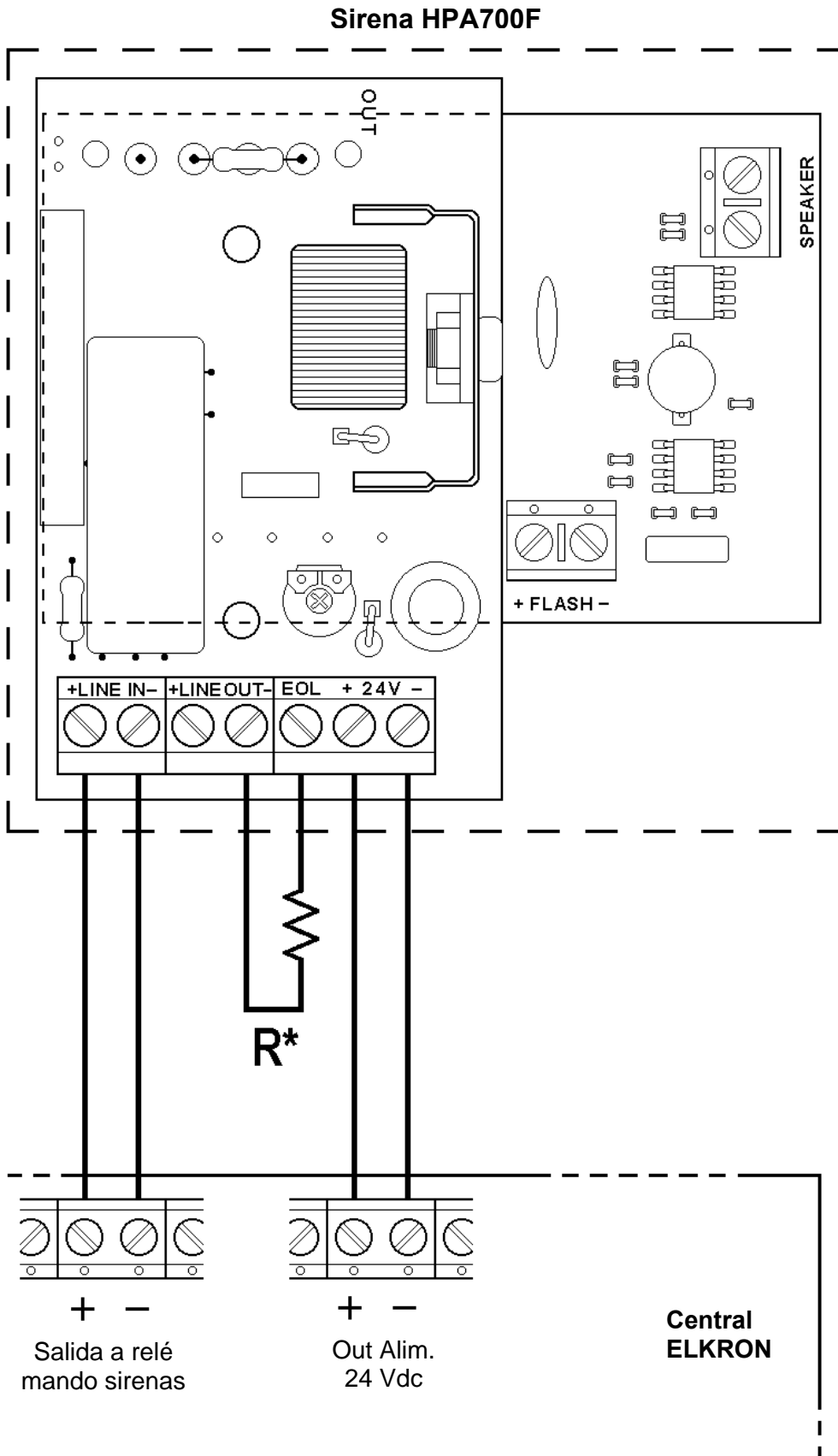

4.2 Conexión con sirenas/campanas

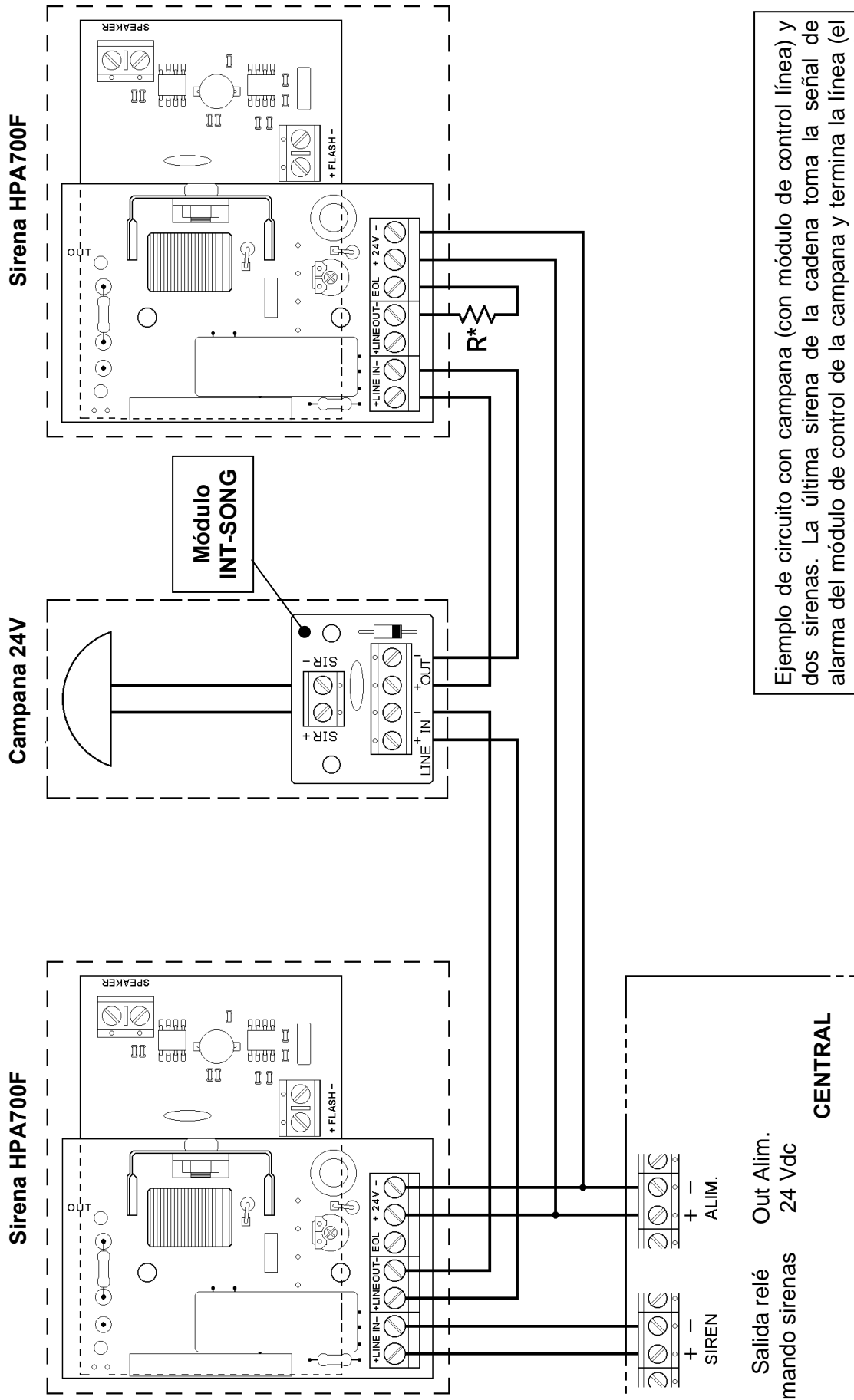

Ejemplo de circuito con campana (con módulo de control línea) y dos sirenas. La última sirena de la cadena toma la señal de alarma del módulo de control de la campana y termina la línea (el negativo de la línea de alarma está conectado en el borne EOL mediante la R^* equil. exterior).

5.0 CARACTERÍSTICAS TÉCNICAS

Bloqueo del sonido en la primera alimentación	
Tensión nominal de alimentación.....	24 Vdc
Tensión mínima de funcionamiento:	18 Vdc
Tensión máxima de funcionamiento:	30 Vdc
Absorción en reposo:	24 mA típicos
Absorción máx. de recarga de batería:	650 mA
Absorción en alarma:	1A con tensión nominal
Potencia máx en alarma:	24W
Potencia lámpara incandescente:	10W
Grado de protección cubierta certificado (EN 60529):	IP33C
Grado de protección cubierta declarado por el fabricante:	IP43
Grado de resistencia mecánica IK declarado por el fabricante:.....	IK08
Frecuencia de funcionamiento:	2400÷2800 Hz
Acumulador asignable:.....	12V 1.9Ah, 12V 2Ah, 12V 2.1Ah
Temp. de funcionamiento certificada:	-25 °C ÷ +70°C
Capacidad contactos relé R control fin de línea.....	6 A @ 24 Vdc
Dimensiones (l x h x p):.....	212 x 270 x 78 mm

ESPECTRO DE EMISIÓN ACÚSTICA A 1 METRO

HPA700F – PLANO HORIZONTAL [dB(A)] a 1m.						
Ángulo	15°	45°	75°	105°	135°	165°
Con la batería	100	105	109	110	105	101
Sin batería	100	105	109	110	104	101

HPA700F – PLANO VERTICAL [dB(A)] a 1m.						
Ángulo	15°	45°	75°	105°	135°	165°
Con la batería	100	106	108	108	109	102
Sin batería	100	105	107	109	108	102

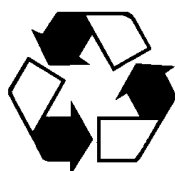

IMPORTANTE: las baterías se consideran residuos peligrosos (C.E.R. 160601) y, por lo tanto, deben ser entregadas a los centros de eliminación autorizados.

ELKRON



ELKRON

Tel. +39 011.3986711 - Fax +39 011.3986703
www.elkron.com – mail to: info@elkron.it

ELKRON è un marchio commerciale di **URMET S.p.A.**
ELKRON is a trademark of **URMET S.p.A.**
Via Bologna, 188/C - 10154 Torino (TO) – Italy
www.urmet.com