

design makes objects timeless,
fashion corrupts them,
fools copy them and sell them to ignorants and idiots.
we do projects and work to help light to bring
you true emotion.
the results of our ideas and our projects
are protected by patents
and/or registered models
and/or copyright.

los proyectos hacen los objetos eternos,
las modas los corrompen,
los imbéciles los copian y los venden a los ignorantes y a los idiotas.
nosotros hacemos proyectos y trabajamos
para ayudar a la luz a emocionarle.
los frutos de nuestras ideas y de nuestros proyectos
están protegidos con patentes,
modelos registrados y derechos de autor.

mario nanni

Alvaline

For m

Viabizzuno is the name of the main road of the small village bizzuno located in the province of ravenna, where I was born on the 21 07 1955 at n°17, between the 'casa del popolo' and the local parish church. from here the name of the company founded in nineteen ninety-four represented by a white space intersected by two lines one vertical, well balanced, logical, clean, For m, the other dynamic, irreverent, ironic, Alvaline. separate and yet complementary, just like the two different philosophies behind Viabizzuno two collections. in the intersection between the two lines, UpO, Ufficio progettazione Ombre.

Viabizzuno, calle principal del anejo de bizzuno, provincia de ravenna, donde, el 21 07 1955, nací, en el n°17, entre el ayuntamiento y la parroquia. de aquí nace el nombre de la empresa establecida en el año mil noveciento noventa y cuatro representada por un espacio blanco atravesado por dos líneas, una vertical, rigurosa, limpia, equilibrada, For m, y otra inclinada, irreverente en el espacio, irónica, fuera de los esquemas, Alvaline. distintas pero complementarias, igual que las dos almas representadas por las dos colecciones Viabizzuno. y en el punto en el que se cruzan las dos líneas, el UpO, Ufficio progettazione Ombre. mn

Viabizzuno progettiamo la luce

Viabizzuno draws on all its experience, knowledge and research to fully express its own personal way of creating light. this tool is a technical manual, a collection, account and explanation of the two product ranges generated by Viabizzuno's design concept, which takes the form of a white page, always ready to accept and solve a new challenge. two complementary ranges occupy this space, exploring and expanding it; they intersect, confident in their own identity, two kindred spirits represented by the For m and Alvaline collections. two tools that together enable us to design lighting in 360°. the For m and Alvaline manual becomes a single book but with two pathways; in one it is the shape that excites and illuminates, in the other it is the design that generates the light, in one is the irreverent lamp, the object that is alive in both artificial and natural light, in the other is the efficient light fitting that disappears to make way for light alone, two different but complementary product types. the manual is a tool to learn about our light, both the historical and the special, developed and made to measure, which explains how important it is for the design to be stimulating and for the customer to be prepared for a complex design process, which requires both time and commitment.

we design lighting at 360°.

Viabizzuno se rodea de experiencia, conocimientos e investigación para poder dar la mejor expresión posible a su modo de hacer luz. este instrumento es un manual técnico: la recopilación, el relato, la explicación de las dos líneas de producto que nacen del pensamiento proyectual de Viabizzuno que se identifica en una página blanca, siempre lista para aceptar y resolver nuevos desafíos. dos líneas complementarias ocupan ese espacio explorándolo, dilatándolo: se cruzan, seguras de su propia identidad, dos almas representadas por las colecciones For m y Alvaline. dos instrumentos que, unidos, nos permiten proyectar la luz a 360°. el manual For m y Alvaline forma así un único libro, pero con dos recorridos: en uno es la forma la que emociona e ilumina, en otro es el diseño el que genera la luz; en un recorrido tenemos la lámpara irreverente, el objeto que vive tanto en la luz artificial como en la natural; en el otro, el cuerpo iluminante, técnico, que desaparece para dejar espacio únicamente a la luz. dos tipos de producto distintos, pero complementarios. es el instrumento para conocer nuestra luz: la histórica, pero también la especial, desarrollada y creada a medida, que narra lo importante que es que el proyecto sea estimulante y que el interlocutor esté preparado para un proyecto complejo, que requerirá tiempo y esfuerzo.

proyectamos la luz a 360°.

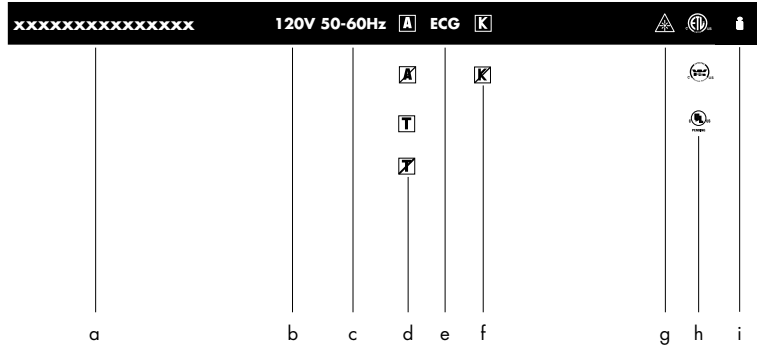

example of data plate. standard arrangement of symbols.
ejemplo de recuadro técnico. posiciones estándar y símbolos.

a	lighting system name nombre del aparato de iluminación
b	supply rating (Volt). tensión de alimentación.
c	supply frequency (Hertz). frecuencia de alimentación.
d	power supply unit/transformer included or not alimentador/transformador incluidos o no incluidos
e	type of control gear. tipo de alimentador.
f	wiring kit included or excluded capacitor for power factor correction only if indicated kit de cableado incluido o excluido condensador de reajuste de fase incluido sólo si se indica
g	led light source. fuente luminosa led.
h	certification for safety and quality standards aparato aprobado, Marca de Calidad
i	net weight. Kg. peso neto.

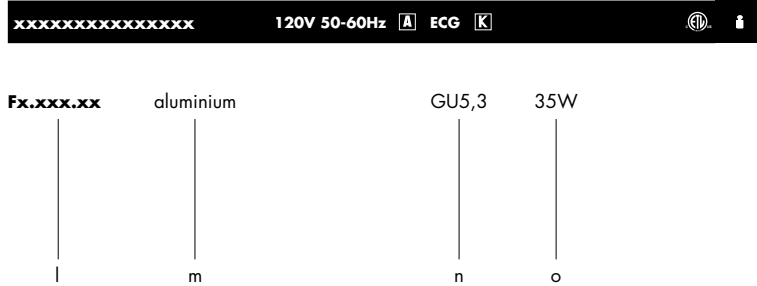

l	code. código.
m	colours and finish. color y acabado.
n	lamp socket. conexión de la bombilla.
o	lamp wattage (Watt). potencia de la bombilla (Watt).

components. componentes.	IK10		
---------------------------------	-------------	--	--

components - includes all items that are essential to the correct operation and installation of the light system
componentes - indica todos los elementos indispensables para la instalación y el buen funcionamiento del cuerpo iluminante.



















accessories. accesorios.	IK10		
---------------------------------	-------------	--	--

accessories - refers to items that can be added to the fitting
accesorios - se refiere a otras partes que pueden instalarse en el cuerpo

kit	IK10		
------------	-------------	--	--

kit - refers to the lighting kits available for installation in the body
kit - se refiere a los kit de iluminación que pueden instalarse dentro del cuerpo.

legenda

-  opal glass. cristal opalino.
-  frosted glass. cristal arenado.
-  transparent glass. cristal transparente.
-  opal polycarbonate diffuser. policarbonado opalino.
-  polycarbonate coextruded. extrusion de policarbonado.
-  drive over. apto para tránsito de vehículos.
-  lamp included. all our lighting system led are with lamp included.
bombilla incluida. todos nuestros cuerpos iluminantes cableados led llevan la fuente luminosa incluida.
-  control gear included. alimentador incluido.
-  control gear not included. alimentador excluido.
-  transformer not included. transformador incluido.
-  transformer not included. transformador excluido.
-  wiring kit. transformador excluido.
-  wiring kit not included. kit de cableaje excluido.
-  produced in compliance with showerheads northamerican directives. producto conforme a las normas norteamericanas de duchas.
-  produced in compliance with northamerican directives. producto conforme a las normas norteamericanas.
-  produced in compliance with lighting northamerican directives. producto conforme a las normas norteamericanas de iluminación.
- ECG** electronic gears. alimentador electrónico halogenuros.
- CCG** electromechanic gear. alimentador electromecánico halogenuros.
-  net weight. Kg. peso neto.
-  trafo 12V spotlight with integral transformer. faro 12V con transformador instalado.

 ATTENTION: never look straight at the light source without eye protection
ATENCIÓN: no mirar directamente a la fuente luminosa

installation shots do not necessary refer to northamerica projects
las fotos de instalación no se refieren necesariamente a proyectos realizados en norteamérica

tubino sospensione mario nanni 2014



suspension light fitting in extruded aluminium for interior use, available in the finishes acciaio acciaio and satin finish gold. made of two profiles with 0.7" diameter and a 0.2" high anti-glare louvre on one side. available lengths: 39.4" and 78.7", wired with 47W and 94W 3000K leds. the profiles are suspended with a steel cable and closed with an extruded frosted polycarbonate diffuser having the same length of the profile, for homogeneous lighting. 24Vdc power supply unit not included, to be located in a remote place.

cuerpo iluminante en suspensión para interiores en aluminio extruido, disponible en los acabados: acciaio acciaio y oro satinado. realizado con dos perfiles de 0.7" de diámetro con una aleta antidestello de 0.2" de alto en un lado, de longitud 39.4" o 78.7" cableados con led 3000K 47W y 94W. los perfiles se cuelgan mediante un cable de acero, cerrados con un difusor extruido de policarbonato arenado de la misma longitud que el perfil para difundir la luz en modo homogéneo. alimentador 24Vcc no incluido para alojar en lugar remoto.



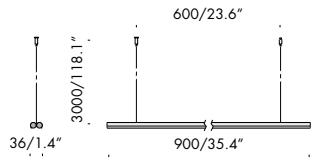

tubino s		24Vdc			
F8.550.01	acciaio acciaio acciaio acciaio	led 3000K led 3000K	47W	35.4" 900mm	
F8.550.02	gold V oro V	led 3000K led 3000K	47W	35.4" 900mm	

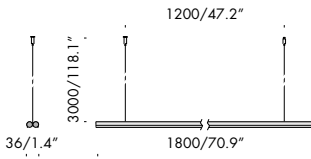

F8.550.11	acciaio acciaio acciaio acciaio	led 3000K led 3000K	94W	70.9" 1800mm	
F8.550.12	gold V oro V	led 3000K led 3000K	94W	70.9" 1800mm	

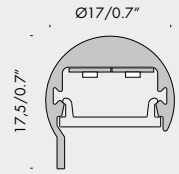

1:1 section tubino s
sección 1:1 tubino s

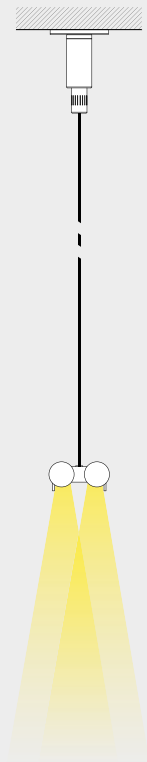

componenti. components.

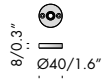

Vb9.550.50 ceiling support cable locks
soporte prensacables para plafón

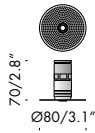

Vb9.550.51 total recessed brick/plasterboard support cable locks
soporte prensacables para ladrillo/cartón yeso completamente al ras

installation example with ceiling support cable locks
ejemplo de instalación con soporte prensacables para plafón

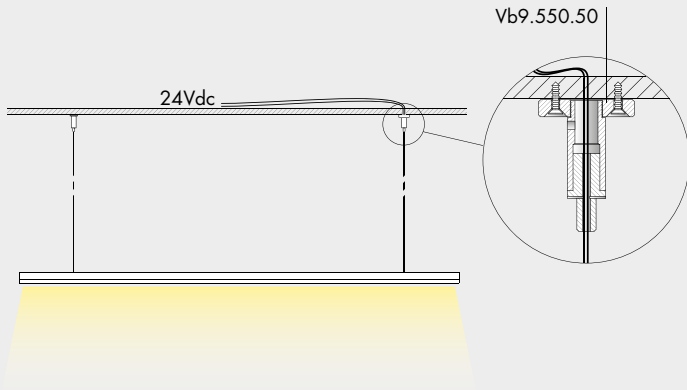

installation example with total recessed brick/plasterboard support cable locks
ejemplo de instalación con soporte prensacables para ladrillo/cartón yeso

brick
ladrillo

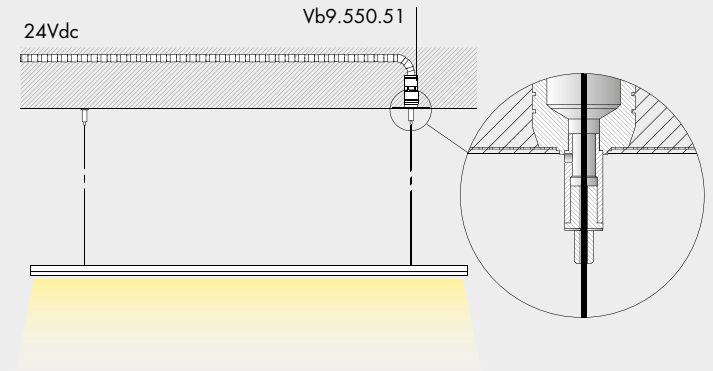

plasterboard
cartón yeso

