

los proyectos hacen los objetos eternos,
las modas los corrompen,
los imbéciles los copian y los venden a los ignorantes y a los idiotas.
nosotros hacemos proyectos y trabajamos
para ayudar a la luz a emocionarle.
los frutos de nuestras ideas y de nuestros proyectos
están protegidos con patentes,
modelos registrados y derechos de autor.
design makes objects timeless,
fashion corrupts them,
fools copy them and sell them to ignorants and idiots.
we do projects and work to help light to bring
you true emotion.
the results of our ideas and our projects
are protected by patents
and/or registered models
and/or copyright.

mario nanni

Alvaline

For m

Viabizzuno, calle principal del anejo de Bizzuno, provincia de ravenna, donde, el 21 07 1955, nací, en el n°17, entre el ayuntamiento y la parroquia. de aquí nace el nombre de la empresa establecida en el año mil noveciento noventa y cuatro representada por un espacio blanco atravesado por dos líneas, una vertical, rigurosa, limpia, equilibrada, For m, y otra inclinada, irreverente en el espacio, irónica, fuera de los esquemas, Alvaline. distintas pero complementarias, igual que las dos almas representadas por las dos colecciones Viabizzuno. y en el punto en el que se cruzan las dos líneas, el UpO, Ufficio progettazione Ombre.

Viabizzuno is the name of the main road of the small village Bizzuno located in the province of ravenna, where I was born on the 21 07 1955 at n°17, between the 'casa del popolo' and the local parish church. from here the name of the company founded in nineteen ninety-four represented by a white space intersected by two lines one vertical, well balanced, logical, clean, For m, the other dynamic, irreverent, ironic, Alvaline. separate and yet complementary, just like the two different philosophies behind Viabizzuno two collections. in the intersection between the two lines, UpO, Ufficio progettazione Ombre. mn

Viabizzuno progettiamo la luce

Viabizzuno se rodea de experiencia, conocimientos e investigación para poder dar la mejor expresión posible a su modo de hacer luz. este instrumento es un manual técnico: la recopilación, el relato, la explicación de las dos líneas de producto que nacen del pensamiento proyectual de Viabizzuno que se identifica en una página blanca, siempre lista para aceptar y resolver nuevos desafíos. dos líneas complementarias ocupan ese espacio explorándolo, dilatándolo: se cruzan, seguras de su propia identidad, dos almas representadas por las colecciones For m y Alvaline. dos instrumentos que, unidos, nos permiten proyectar la luz a 360°. el manual For m y Alvaline forma así un único libro, pero con dos recorridos: en uno es la forma la que emociona e ilumina, en otro es el diseño el que genera la luz; en un recorrido tenemos la lámpara irreverente, el objeto que vive tanto en la luz artificial como en la natural; en el otro, el cuerpo iluminante, técnico, que desaparece para dejar espacio únicamente a la luz. dos tipos de producto distintos, pero complementarios. es el instrumento para conocer nuestra luz: la histórica, pero también la especial, desarrollada y creada a medida, que narra lo importante que es que el proyecto sea estimulante y que el interlocutor esté preparado para un proyecto complejo, que requerirá tiempo y esfuerzo.

proyectamos la luz a 360°.

Viabizzuno draws on all its experience, knowledge and research to fully express its own personal way of creating light. this tool is a technical manual, a collection, account and explanation of the two product ranges generated by Viabizzuno's design concept, which takes the form of a white page, always ready to accept and solve a new challenge. two complementary ranges occupy this space, exploring and expanding it; they intersect, confident in their own identity, two kindred spirits represented by the For m and Alvaline collections. two tools that together enable us to design lighting in 360°. the For m and Alvaline manual becomes a single book but with two pathways; in one it is the shape that excites and illuminates, in the other it is the design that generates the light, in one is the irreverent lamp, the object that is alive in both artificial and natural light, in the other is the efficient light fitting that disappears to make way for light alone, two different but complementary product types. the manual is a tool to learn about our light, both the historical and the special, developed and made to measure, which explains how important it is for the design to be stimulating and for the customer to be prepared for a complex design process, which requires both time and commitment.

we design lighting at 360°.



ejemplo de recuadro técnico. posiciones estándar y símbolos.
example of data plate. standard arrangement of symbols.

a	nombre del aparato de iluminación lighting system name
b	tensión de alimentación. supply rating (Volt).
c	frecuencia de alimentación. supply frequency (Hertz) .
d	alimentador/transformador incluidos o no incluidos power supply unit / transformer included or not
e	tipo de alimentador. type of control gear.
f	kit de cableado incluido o excluido condensador de reajuste de fase incluido sólo si se indica wiring kit included or excluded capacitor for power factor correction only if indicated
g	clase de seguridad. insulation class.
h	grado de la protección. protection rating.
i	montaje directo sobre superficies normalmente inflamables direct mounting on flammable surfaces
k	aparato aprobado, Marca de Calidad certification for safety and quality standards
l	fuentes luminosas led. led light source. luminarias donde se pueden instalar lamparas a led a pedir despues de verificar la compatibilidad electrica y mecánica. light fittings that can be install led light sources to be ordered separately after checking their electrical and mechanical compatibility
m	producto conforme con las directivas europeas produced in compliance with EC directives
n	peso neto. net weight. Kg.

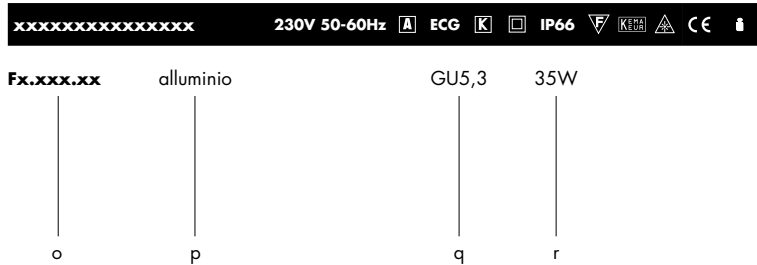

o	código. code.
p	color y acabado. colours and finish.
q	conexión de la bombilla. lamp socket.
r	potencia de la bombilla (Watt). lamp wattage (Watt).

componentes. components.	IK10	CE	i
---------------------------------	-------------	-----------	----------

componentes - indica todos los elementos indispensables para la instalación y el buen funcionamiento del cuerpo iluminante.
components - includes all items that are essential to the correct operation and installation of the light system

accesorios. accessories.	IK10	CE	i
---------------------------------	-------------	-----------	----------













accesorios - se refiere a otras partes que pueden instalarse en el cuerpo
accessories - refers to items that can be added to the fitting

kit	IK10	CE	i
------------	-------------	-----------	----------

kit - se refiere a los kit de iluminación que pueden instalarse dentro del cuerpo.
kit - refers to the lighting kits available for installation in the body

Viabizzuno si riserva il diritto di apportare ai propri modelli, senza nessun preavviso, qualsiasi modifica ritenesse opportuna. Viabizzuno reserves the right to introduce any change to its own models, without prior notice. Viabizzuno behält sich das Recht vor jederzeit und ohne Ankündigung die technischen Daten der im Katalog abgebildeten Produkte zu ändern. Viabizzuno se reserva el derecho de aportar a sus modelos, sin ningún preaviso, cualquier modificación que considere oportuna. Viabizzuno se réserve le droit d'apporter une quelconque modification aux produits sans préavis. Viabizzuno оставляет за собой право внести любые изменения в свои модели без предварительного уведомления.

legenda

-  clase I, sólo aislamiento fundamental; además, las partes conductoras accesibles están conectados a un conductor de tierra. puesta a tierra indispensable. class I, only basic insulation, accessible conductors are earthed. earthing compulsory.
-  clase II, al aislamiento fundamental se añade un segundo aislamiento, o bien los dos aislamientos se reemplazan por un aislamiento reforzado. class II, basic insulation plus second insulation or both are replaced by reinforced insulation. earthing excluded
-  clase III, alimentación realizada con voltaje bajísimo de seguridad class III, very low safety supply tension; not to be used over 50V-50Hz. earthing excluded.
-  aparatos adecuados para el montaje directo sobre superficies normalmente inflamables. luminaires suitable for direct mounting on flammable surfaces.
-  cristal opalino. opal glass.
-  cristal arenado. frosted glass.
-  cristal transparente. transparent glass.
-  policarbonado opalino. opal polycarbonate diffuser.
-  extrusion de policarbonado. polycarbonate coextruded.
-  apto para tránsito de vehículos. drive over.
-  bombilla incluida. todos nuestros cuerpos iluminantes cableados led llevan la fuente luminosa incluida. lamp included. all our lighting system led are with lamp included.
-  alimentador incluido. control gear included.
-  alimentador excluido. control gear not included.
-  condensador de compensación incluido. capacitor for power factor correction included.
-  Trafo nicht mitgeliefert. transformer not included.
-  Trafo nicht mitgeliefert. transformer not included.
-  transformador excluido. wiring kit.
-  kit de cableaje excluido. wiring kit not included.
-  producto conforme con las directivas europeas. produced in compliance with EC directives.
-  aprobado KEMA. KEMA approved.
- ECCG** alimentador electrónico halogenuros. electronic gears.
- CCG** alimentador electromecánico halogenuros. electromechanic gear.
-  Nettogewicht Kg. net weight.
- .SA** kit flúo + emergencia siempre encendidos. **Nota: no se puede instalar en las arquetas de ladrillo**
fluorescent kit with permanently lit emergency lamp **NB: cannot be installed in brickwork housing**
- .SE** sólo emergencia siempre encendida **Nota: no se puede instalar en las arquetas de ladrillo**
permanently lit emergency lamp only **NB: cannot be installed in brickwork housing**
- .D1** reóstato 1-10V. 1-10V dimmer.
- .D2** reóstato dali. dimmer dali.
- .T** faro 12V con transformador instalado. Trafo 12V spotlight with integral transformer.
-  ATENCIÓN: no mirar directamente a la fuente luminosa
ATTENTION: never look straight at the light source without eye protection
-  luminarias donde se pueden instalar lamparas a led a pedir despues de verificar la compatibilidad electrica y mecánica.
light fittings that can be install led light sources to be ordered separately after checking their electrical and mechanical compatibility



cuerpo iluminante en suspensión para interiores IP20 constituido por una estructura de acero pintado en antracita de 120x180x2400mm; disponible con cableado de lámparas fluorescentes tubulares de alta emisión T5 G5 4x54W HO 240V, y con fuente led lineal de alta eficiencia 3000K Ra90 182W 19680lm 240V. en todas las versiones lleva una óptica de láminas difusoras formada por aletas de latón natural arenado para un excelente confort visual, y un atenuador integrado 1-10V realizado con una varilla de latón natural que permite regular fácilmente el flujo luminoso. la lámpara está disponible con suspensión fija o subibaja, esta última dotada de un mecanismo de regulación integrado en la estructura, estudiado y patentado por Viabizzuno, que permite regular con extrema facilidad la altura de la superficie de trabajo con una salida de 500mm. alimentadores incluidos. también pueden utilizarse el rosetón completamente al ras, o el de plafón.

IP20-rated suspension light fitting consisting of an anthracite painted steel structure measuring 120x180x2400mm; available cabled with T5 G5 4x54W HO 240V high-emission fluorescent tubular lighting, and with a 3000K Ra90 182W 19680lm 240V high-efficiency linear led source. all versions have an anti-glare louvre diffuser with natural sanded brass louvres for optimal visual comfort, and a built-in 1-10V dimmer with a natural brass rod, used to easily adjust the light flow. the lamp is available in fixed or rise and fall versions. the latter has an adjustment mechanism incorporated into the structure, designed and patented by Viabizzuno, to easily adjust the height from the work surface, with a range of 500mm. power supply units included. it is possible to use a fully concealed rose, or the ceiling mount.

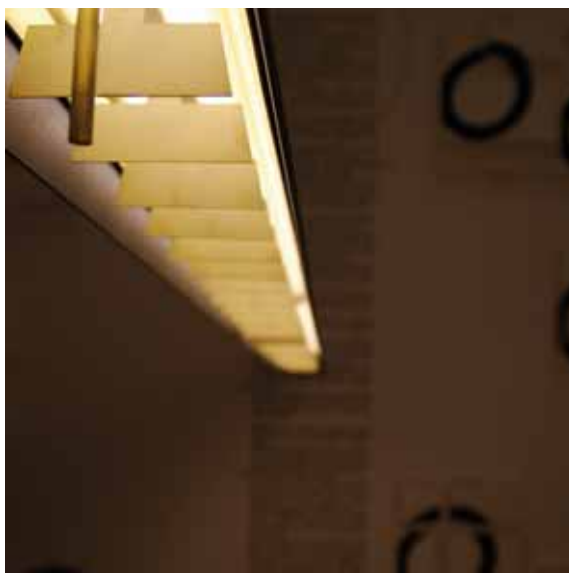

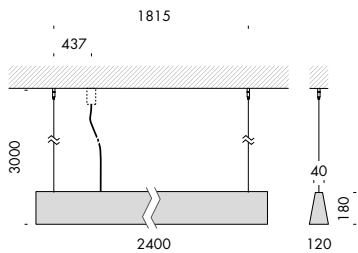

barra d'oro fissa

240V 50-60Hz



F8.212.53 antracita
anthracite

G5

4x54W

HO

35,0

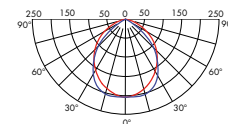

cd/klm

—C0C180 —C90C270

54W

h	d1	d2	Em	E _{max}
1m	2,1	2,3	1533	3630
2m	4,2	4,7	383	908
3m	6,2	7	170	403
4m	8,3	9,4	96	227

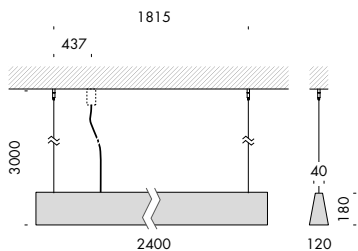

barra d'oro fissa

240V 50-60Hz



Vb8.212.61 antracita
anthracite

led 3000K

182W 19680lm

35,0

componentes. components.

CE



F9.001.92 florón exterior aluminio satinado plata opaco
externally visible satined aluminium matt silver canopy

3,5

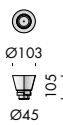

F9.001.81 florón empotrado
recessed canopy

3,5

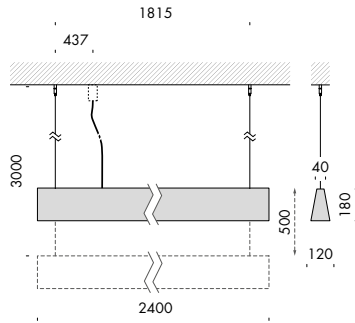

barra d'oro saliscendi

240V 50-60Hz



F8.212.51 antracite
anthracite

G5

4x54W

HO

35,0

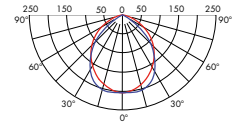

cd/klm
— C0:C180 — C90:C270

54W

h	d1	d2	Em	Emax
1m	2,1	2,3	1533	3630
2m	4,2	4,7	383	908
3m	6,2	7	170	403
4m	8,3	9,4	96	227

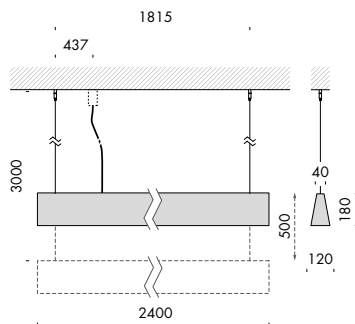

barra d'oro saliscendi

240V 50-60Hz



Vb8.212.71 antracite
anthracite

led 3000K

182W

19680lm

35,0

componentes. components.



F9.001.92 florón exterior aluminio satinado plata opaco
externally visible satined aluminium matt silver canopy 3,5

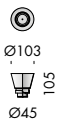

F9.001.81 florón empotrado
recessed canopy 3,5





