

design makes objects timeless,
fashion corrupts them,
fools copy them and sell them to ignorants and idiots.
we do projects and work to help light to bring
you true emotion.
the results of our ideas and our projects
are protected by patents
and/or registered models
and/or copyright.

los proyectos hacen los objetos eternos,
las modas los corrompen,
los imbéciles los copian y los venden a los ignorantes y a los idiotas.
nosotros hacemos proyectos y trabajamos
para ayudar a la luz a emocionarle.
los frutos de nuestras ideas y de nuestros proyectos
están protegidos con patentes,
modelos registrados y derechos de autor.

mario nanni

Alvaline

For m

Viabizzuno is the name of the main road of the small village bizzuno located in the province of ravenna, where I was born on the 21 07 1955 at n°17, between the 'casa del popolo' and the local parish church. from here the name of the company founded in nineteen ninety-four represented by a white space intersected by two lines one vertical, well balanced, logical, clean, For m, the other dynamic, irreverent, ironic, Alvaline. separate and yet complementary, just like the two different philosophies behind Viabizzuno two collections. in the intersection between the two lines, UpO, Ufficio progettazione Ombre.

Viabizzuno, calle principal del anejo de bizzuno, provincia de ravenna, donde, el 21 07 1955, nací, en el n°17, entre el ayuntamiento y la parroquia. de aquí nace el nombre de la empresa establecida en el año mil noveciento noventa y cuatro representada por un espacio blanco atravesado por dos líneas, una vertical, rigurosa, limpia, equilibrada, For m, y otra inclinada, irreverente en el espacio, irónica, fuera de los esquemas, Alvaline. distintas pero complementarias, igual que las dos almas representadas por las dos colecciones Viabizzuno. y en el punto en el que se cruzan las dos líneas, el UpO, Ufficio progettazione Ombre. mn

Viabizzuno progettiamo la luce

Viabizzuno draws on all its experience, knowledge and research to fully express its own personal way of creating light. this tool is a technical manual, a collection, account and explanation of the two product ranges generated by Viabizzuno's design concept, which takes the form of a white page, always ready to accept and solve a new challenge. two complementary ranges occupy this space, exploring and expanding it; they intersect, confident in their own identity, two kindred spirits represented by the For m and Alvaline collections. two tools that together enable us to design lighting in 360°. the For m and Alvaline manual becomes a single book but with two pathways; in one it is the shape that excites and illuminates, in the other it is the design that generates the light, in one is the irreverent lamp, the object that is alive in both artificial and natural light, in the other is the efficient light fitting that disappears to make way for light alone, two different but complementary product types. the manual is a tool to learn about our light, both the historical and the special, developed and made to measure, which explains how important it is for the design to be stimulating and for the customer to be prepared for a complex design process, which requires both time and commitment.

we design lighting at 360°.

Viabizzuno se rodea de experiencia, conocimientos e investigación para poder dar la mejor expresión posible a su modo de hacer luz. este instrumento es un manual técnico: la recopilación, el relato, la explicación de las dos líneas de producto que nacen del pensamiento proyectual de Viabizzuno que se identifica en una página blanca, siempre lista para aceptar y resolver nuevos desafíos. dos líneas complementarias ocupan ese espacio explorándolo, dilatándolo: se cruzan, seguras de su propia identidad, dos almas representadas por las colecciones For m y Alvaline. dos instrumentos que, unidos, nos permiten proyectar la luz a 360°. el manual For m y Alvaline forma así un único libro, pero con dos recorridos: en uno es la forma la que emociona e ilumina, en otro es el diseño el que genera la luz; en un recorrido tenemos la lámpara irreverente, el objeto que vive tanto en la luz artificial como en la natural; en el otro, el cuerpo iluminante, técnico, que desaparece para dejar espacio únicamente a la luz. dos tipos de producto distintos, pero complementarios. es el instrumento para conocer nuestra luz: la histórica, pero también la especial, desarrollada y creada a medida, que narra lo importante que es que el proyecto sea estimulante y que el interlocutor esté preparado para un proyecto complejo, que requerirá tiempo y esfuerzo.

proyectamos la luz a 360°.

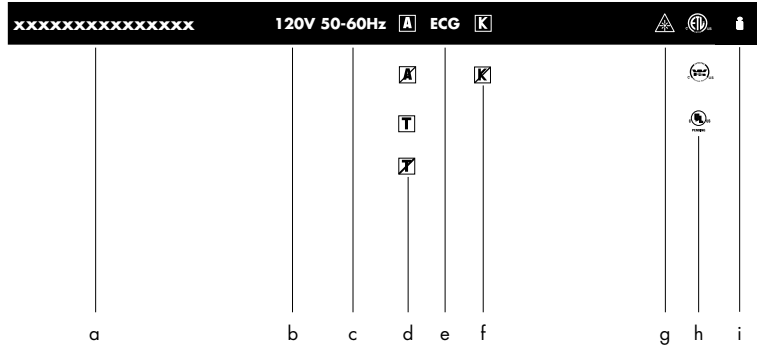

example of data plate. standard arrangement of symbols.
ejemplo de recuadro técnico. posiciones estándar y símbolos.

a	lighting system name nombre del aparato de iluminación
b	supply rating (Volt). tensión de alimentación.
c	supply frequency (Hertz). frecuencia de alimentación.
d	power supply unit/transformer included or not alimentador/transformador incluidos o no incluidos
e	type of control gear. tipo de alimentador.
f	wiring kit included or excluded capacitor for power factor correction only if indicated kit de cableado incluido o excluido condensador de reajuste de fase incluido sólo si se indica
g	led light source. fuente luminosa led.
h	certification for safety and quality standards aparato aprobado, Marca de Calidad
i	net weight. Kg. peso neto.

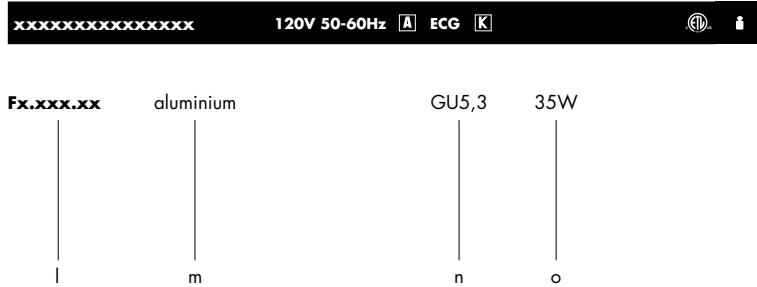

l	code. código.
m	colours and finish. color y acabado.
n	lamp socket. conexión de la bombilla.
o	lamp wattage (Watt). potencia de la bombilla (Watt).

components. componentes.	IK10		
---------------------------------	-------------	--	--

components - includes all items that are essential to the correct operation and installation of the light system
componentes - indica todos los elementos indispensables para la instalación y el buen funcionamiento del cuerpo iluminante.

















accessories. accesorios.	IK10		
---------------------------------	-------------	--	--

accessories - refers to items that can be added to the fitting
accesorios - se refiere a otras partes que pueden instalarse en el cuerpo

kit	IK10		
------------	-------------	--	--

kit - refers to the lighting kits available for installation in the body
kit - se refiere a los kit de iluminación que pueden instalarse dentro del cuerpo.

legenda

-  opal glass. cristal opalino.
-  frosted glass. cristal arenado.
-  transparent glass. cristal transparente.
-  opal polycarbonate diffuser. policarbonado opalino.
-  polycarbonate coextruded. extrusion de policarbonado.
-  drive over. apto para tránsito de vehículos.
-  lamp included. all our lighting system led are with lamp included.
bombilla incluida. todos nuestros cuerpos iluminantes cableados led llevan la fuente luminosa incluida.
-  control gear included. alimentador incluido.
-  control gear not included. alimentador excluido.
-  transformer not included. transformador incluido.
-  transformer not included. transformador excluido.
-  wiring kit. transformador excluido.
-  wiring kit not included. kit de cableaje excluido.
-  produced in compliance with showerheads northamerican directives. producto conforme a las normas norteamericanas de duchas.
-  produced in compliance with northamerican directives. producto conforme a las normas norteamericanas.
-  produced in compliance with lighting northamerican directives. producto conforme a las normas norteamericanas de iluminación.
- ECG** electronic gears. alimentador electrónico halogenuros.
- CCG** electromechanic gear. alimentador electromecánico halogenuros.
-  net weight. Kg. peso neto.
- .T** trafo 12V spotlight with integral transformer. faro 12V con transformador instalado.

 ATTENTION: never look straight at the light source without eye protection
ATENCIÓN: no mirar directamente a la fuente luminosa

installation shots do not necessary refer to northamerica projects
las fotos de instalación no se refieren necesariamente a proyectos realizados en norteamérica



indoor multipurpose lighting system that can be assembled with different accessories and wiring kits, offering designers a wide range of technical and aesthetic possibilities. available in ceiling or wall recessed versions. made of white, grey and black painted metal, it is equipped to house wiring kits for halogen or metal halide lamps, which may all be interchanged.

sistema de iluminación multifuncional para interiores; puede ensamblarse con distintos accesorios y cableados para ofrecer al proyectista soluciones luminotécnicas y estéticas de gran versatilidad. disponible en las versiones empotrada de techo o en pared. construido en metal pintado en blanco, gris y negro, con preajuste para alojar fuentes halógenas y de halógenuros metálicos intercambiables entre sí.



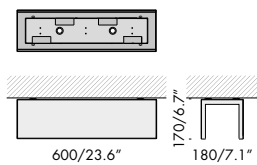

sp1 p.s. 600mm/23.6"



F6.151.01.U	white blanco	max 3 kit	4,1
F6.151.03.U	grey gris	max 3 kit	4,1
F6.151.05.U	black negro	max 3 kit	4,1

fixing hole distance
interdistancia entre agujeros de fijación

fixing hole distance
sp1 p.s. 600mm/23.6"
interdistancia entre agujeros de
fijación sp1 p.s. 600mm/23.6"

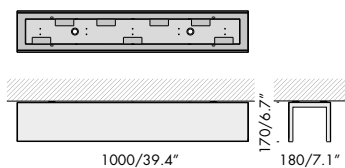

sp1 p.s. 1000mm/39.4"



F6.151.11.U	white blanco	max 5 kit	6,0
F6.151.13.U	grey gris	max 5 kit	6,0
F6.151.15.U	black negro	max 5 kit	6,0

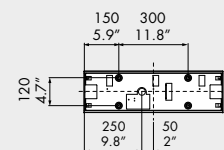

fixing hole distance
sp1 p.s. 1000mm/39.4"
interdistancia entre agujeros
de fijación sp1 p.s. 1000mm/39.4"

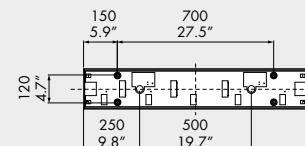

install the kit
instalar kit

ceiling
plafón

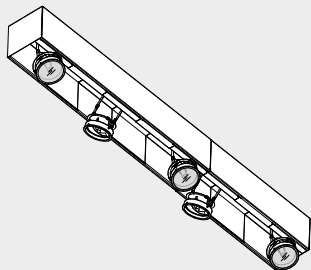

suspension kit F6.151.90.U
F6.151.91
suspensión kit F6.151.90.U
F6.151.91

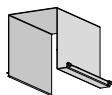
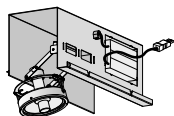
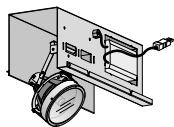
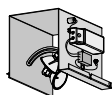
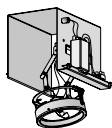
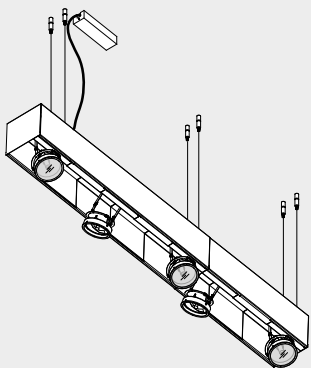

kit	120V 50-60Hz	T	K	Ⓜ	i
F6.151.42.U	halo black halo negro	G53	75W		1,7

kit	120V 50-60Hz	T	K	Ⓜ	i
F6.151.44.U	dicro black dicro negro	GU5,3	2x37W		1,0

kit	120V 50-60Hz	A	ECG	K	Ⓜ	i
F6.151.52.U	metal halide black halogenuros negro	G12	39W	8°		2,8
F6.151.54.U	metal halide black halogenuros negro	G12	39W	40°		2,8
F6.151.56.U	metal halide black halogenuros negro	G12	70W	8°		2,8
F6.151.58.U	metal halide black halogenuros negro	G12	70W	40°		2,8
F6.151.60.U	metal halide black halogenuros negro	GX8,5	39W			2,5
F6.151.62.U	metal halide black halogenuros negro	GX8,5	70W			2,5
F6.151.92	blank housing black cuerpo ciego negro					0,8



example of sp1 arrangement
ejemplo de composición sp1

link the fittings with connection joints
cod. F6.151.94
unirs los modulos con la juntas lineal
cod. F6.151.94

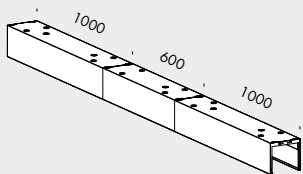
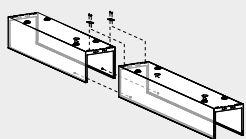

fix the terminal of the body with
the screws supplied
cod. F6.151.82/84/86/88
fijar el cabezal al cuerpo utilizando
los tornillos suministrados
cod. F6.151.82/84/86/88

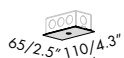
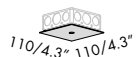
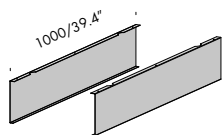
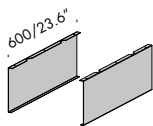
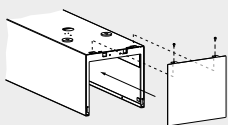

accessories. accesorios.



F6.151.82	closing plate white placa de cobertura blanco	2 pcs 2 uds	0,6
F6.151.84	closing plate grey placa de cobertura gris	2 pcs 2 uds	0,6
F6.151.86	closing plate black placa de cobertura negro	2 pcs 2 uds	0,6
F6.151.88	closing plate polished stainless steel placa de cobertura inoxidable brillante	2 pcs 2 uds	0,6
F6.151.09	pair of polished stainless body covers with magnets pateja de tapas acero inoxidable brillante con imanes		4,1
F6.151.19	pair of polished stainless body covers with magnets pateja de tapas acero inoxidable brillante con imanes		4,1
F6.151.90.U	suspension kit and supply cable kit de suspensión y cable de alimentación	4 wires 4 cables	0,8
F6.151.91	suspension kit kit de suspensión	2 wires 2 cables	0,3
F6.151.94	linear joints pateja de uniones lineales		0,3
F9.007.41	white round rosette USA-canada rosetón blanco redondo USA-canada		0,3
F9.007.42	white square rosette USA-canada rosetón blanco cuadrado USA-canada		0,3
F9.007.43	white rectangular rosette USA-canada rosetón blanco rectangular USA-canada		0,3



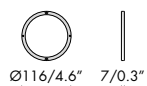

accessories kit. accesorios kit.



F9.001.11 accessory carrier black
porta accesorios negro

0,01

F9.001.12 accessory carrier silver
porta accesorios plate

0,01

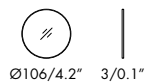

F9.001.21 transparent uv filter
filtro uv transparente

0,08

F9.001.22 frosted uv filter
filtro uv arenado

0,08

F9.001.23 ir filter
filtro ir

0,08



F9.001.25 elliptical lens
lente elíptica

0,1

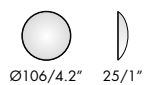

F9.001.27 diffusing lens
lente el difusora

0,1

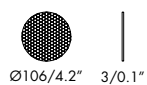

F9.001.31 honeycomb louver
rejilla de panal

0,007

use only with F6.151.42.U/52.U/54.U/56.U/58.U
solo para F6.151.42.U/52.U/54.U/56.U/58.U

sp1 kit G53/GX8,5

F6.151.42.U

assembly example with filter
ejemplo de montaje con filtro

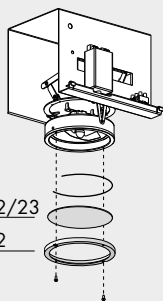

assembly example with elliptical lens / diffusing lens
ejemplo de montaje con lente elíptica / lente difusora

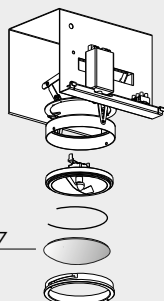

assembly example with louver honeycomb
ejemplo de montaje con rejilla de panel

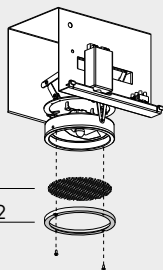

assembly example with 2 accessories
ejemplo de montaje con 2 accesorios

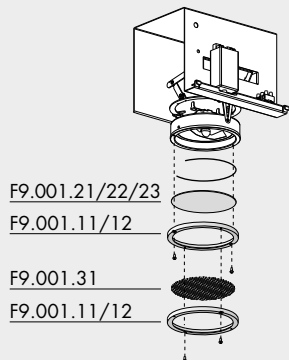

sp1 kit G12

F6.151.52.U F6.151.58.U
F6.151.54.U F6.151.60.U
F6.151.56.U F6.151.62.U

ejemplo de montaje con filtro
assembly example with filter

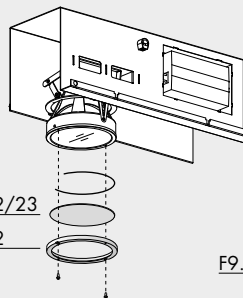

assembly example with elliptical lens / diffusing lens
ejemplo de montaje con lente elíptica / lente difusora

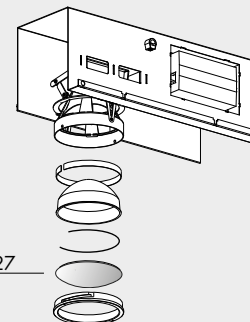

assembly example with louver honeycomb
ejemplo de montaje con rejilla de panel

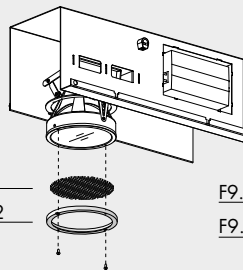

assembly example with 2 accessories
ejemplo de montaje con 2 accesorios

