

Grizzly *Industrial, Inc.*®

MODEL H0778/H0779 ELECTRIC HOIST OWNER'S MANUAL



COPYRIGHT © JULY, 2008 BY GRIZZLY INDUSTRIAL, INC.
**WARNING: NO PORTION OF THIS MANUAL MAY BE REPRODUCED IN ANY SHAPE
OR FORM WITHOUT THE WRITTEN APPROVAL OF GRIZZLY INDUSTRIAL, INC.**
#JM10785 PRINTED IN CHINA

SECTION 1: SAFETY

WARNING!

This manual provides critical safety instructions on the proper setup, operation, maintenance and service of this machine/equipment.

Failure to read, understand and follow the instructions given in this manual may result in serious personal injury, including amputation, electrocution or death.

The owner of this machine/equipment is solely responsible for its safe use. This responsibility includes but is not limited to proper installation in a safe environment, personnel training and usage authorization, proper inspection and maintenance, manual availability and comprehension, application of safety devices, blade/cutter integrity, and the usage of personal protective equipment.

The manufacturer will not be held liable for injury or property damage from negligence, improper training, machine modifications or misuse.

WARNING!

For Your Own Safety Read Instruction Manual Before Operating This Equipment

The purpose of safety symbols is to attract your attention to possible hazardous conditions. This manual uses a series of symbols and signal words which are intended to convey the level of importance of the safety messages. The progression of symbols is described below. Remember that safety messages by themselves do not eliminate danger and are not a substitute for proper accident prevention measures.

DANGER

Indicates an imminently hazardous situation which, if not avoided, WILL result in death or serious injury.

WARNING

Indicates a potentially hazardous situation which, if not avoided, COULD result in death or serious injury.

CAUTION

Indicates a potentially hazardous situation which, if not avoided, MAY result in minor or moderate injury. It may also be used to alert against unsafe practices.

NOTICE

This symbol is used to alert the user to useful information about proper operation of the equipment.

WARNING

Safety Instructions for Electric Hoists

- 1. READ THROUGH THE ENTIRE MANUAL BEFORE USING.** This electric hoist represents serious injury hazards to untrained users.
- 2. NEVER ALLOW UNQUALIFIED PERSONNEL TO SERVICE THIS HOIST.** Servicing the hoist incorrectly may reduce the maximum holding capacity.
- 3. DO NOT LIFT MORE THAN THE MAXIMUM SUGGESTED CAPACITY.** Be aware that the load weight, harnesses, and load bearing equipment all contribute to the total load weight. Overloading may cause the load to fall.
- 4. NEVER LIFT LOADS WHEN TIRED, OR UNDER THE INFLUENCE OF DRUGS OR ALCOHOL.** Be mentally alert at all times when lifting or moving loads.
- 5. ONLY ALLOW TRAINED AND PROPERLY SUPERVISED PERSONNEL TO OPERATE HOIST.** Make sure operation instructions are safe and clearly understood.
- 6. NEVER LEAVE A LOAD WHILE SUSPENDED.** Lower the load to the ground and unhook all loads and harnesses before leaving the electric hoist unattended.
- 7. NEVER SUSPEND THE LOAD OVER OR NEAR A PERSON.** Loads may fall at any given time due to overloading, improper loading procedures, or failure of a component. A cable can slip or break, causing a "whiplash" effect.
- 8. USE ONLY RECOMMENDED ACCESSORIES.** The use of improper accessories may increase risk of injury.
- 9. CHECK FOR DAMAGED PARTS BEFORE USING HOIST.** Check for broken parts, loose bolts, frayed cable, cracked or worn components and any other conditions that may affect machine operation. Repair or replace damaged parts.
- 10. ALWAYS DISCONNECT FROM POWER SOURCE BEFORE SERVICING.** Make sure the switch is in the OFF position and the hoist is unplugged before servicing.
- 11. NEVER LET LOADS SWING.** Unsteady loads may become unbalanced and fall. Swinging motions cause wear on components and may cause them to break.
- 12. USE CORRECT HARNESSSES.** Never use oversized or multiple harnesses in the hook. Use harnesses that are rated for the load being lifted.
- 13. DO NOT EXPOSE THE HOIST OR CORDS TO WET OR RAINY CONDITIONS.** Moisture greatly increases the risk of a shock hazard.
- 14. ENTANGLEMENT HAZARD.** Do not hold the cable during operating—clothing and body parts may get caught in the mechanism.
- 15. NEVER USE THE HOIST FOR HORIZONTAL PULLING OR DRAGGING.** The hoist is designed for vertical movement of a load only. Horizontal motion of a load can put strain on the hoist components and decrease the maximum load capacity due to friction.

SECTION 2: INTRODUCTION

Foreword

It is our pleasure to provide this manual with the Model H0778/H0779. It was written to encourage safety considerations and guide you through general operating procedures and maintenance.

The specifications, details, and photographs in this manual represent the Model H0778/H0779 as supplied when the manual was prepared. However, owing to Grizzly's policy of continuous improvement, changes may be made at any time with no obligation on the part of Grizzly.

Machine Data

MODEL H0778

	SINGLE CABLE	DOUBLE CABLE
MAX CAPACITY	220 lbs.	440 lbs.
LIFTING HEIGHT	33 ft.	16.5 ft.
LIFTING SPEED	38 ft./min.	19 ft/min
CABLE DIAMETER	1/8"	

MODEL H0779

	SINGLE CABLE	DOUBLE CABLE
MAX CAPACITY	440 lbs.	880 lbs.
LIFTING HEIGHT	33 ft.	16.5 ft.
LIFTING SPEED	38 ft./min.	19 ft/min
CABLE DIAMETER	9/64"	

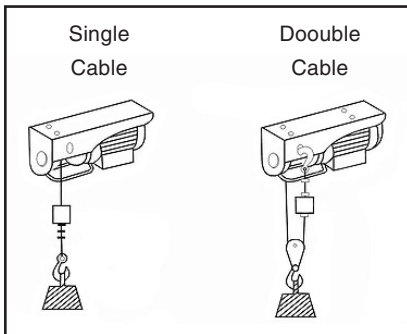

Figure 1. Cable options.

Contact Info

If you have any comments regarding this manual, please contact us:

Grizzly Industrial, Inc.
C/O Technical Documentation Manager
P.O. Box 2069
Bellingham, WA 98227-2069
Email: manuals@grizzly.com

Most importantly, we stand behind our tools. If you have any service questions or parts requests, please call or write us at the location listed below.

Grizzly Industrial, Inc.
1203 Lycoming Mall Circle
Muncy, PA 17756
Phone: (570) 546-9663
Fax: (800) 438-5901
E-Mail: techsupport@grizzly.com
Web Site: <http://www.grizzly.com>

WARNING

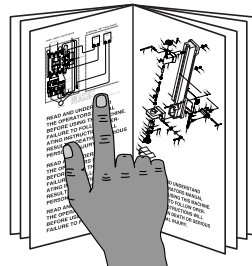

Read the manual before operation. Become familiar with this hoist, its safety instructions, and its operation before beginning any work. Serious personal injury may result if safety or operational information is not understood or followed.

SECTION 3: SET UP

Unpacking

Your electric hoist was carefully packaged for safe shipping. If you discover any damage after you have signed for delivery, *immediately call Customer Service at (570) 546-9663 for advice.*

Save the containers and all packing materials for possible inspection by the carrier or its agent. *Otherwise, filing a freight claim can be difficult.*

When you are completely satisfied with the condition of the shipment, you should inventory the contents.

Inventory

Model H0778/H0779 Inventory (Figure 2)

A.	Electric Hoist	1
B.	Mounting Brackets	2
C.	Pulley Lift Hook	1
D.	Flat Washers	
	8MM (H0778)	4
	10MM (H0779)	4
E.	External Tooth Washers	
	8MM (H0778)	4
	10MM (H0779)	4
F.	Hex Bolts	
	M8-1.25 X 25 (H0778)	4
	M10-1.5 X 25 (H0779)	4

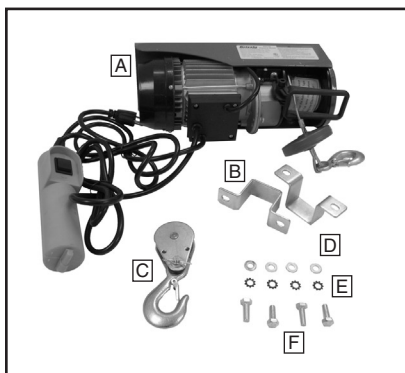

Figure 2. Model H0778/H0779 inventory (Model H0778 shown).

Site Consideration

Weight Capacity

Refer to the weight capacity listed in **Machine Data on Page 2**. When choosing a mounting site, verify that the lifting structure can withstand at least the maximum loading capacity as well as any possible overloading that may occur.

Working Clearances

Consider existing and anticipated needs, dimensions of your lifting platform, size of material to be lifted, and whether you need the hoist to be mobile or in a stationary location when establishing an installation site for your electric hoist.

Power Outlets

The Model H0778/H0779 electric hoist is equipped with a control switch on a 5 ft. long cord. When establishing a site for your hoist, make sure the control switch can be reached and that outlets are located near the hoist so power or extension cords are clear of high-traffic areas.

Setup

The Model H0778/H0779 electric hoist comes pre-assembled. The hoist only needs to be mounted. There are many mounting options for your hoist. It may be mounted on a stationary pipe or on a rotating pillar (**Figure 3**).

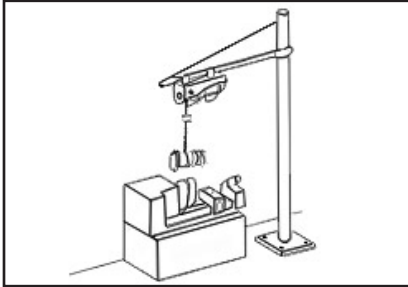

Figure 3. Hoist mounted on a rotating pillar.

Make sure that the selected location is in a well lit environment, the control switch will be able to be reached, and that the cord, plug, and hoist will not be exposed to rain or moisture.

To mount your electric hoist:

1. Place the two mounting brackets over a suitable pipe that will withstand the maximum load capacities and any possible overloading that may occur.
2. Have an assistant hold the hoist in place while the hex bolts, external tooth washers, and flat washers are threaded through each of the mounting brackets and into the top of the electric hoist, as shown in **Figure 4**.

Note: We strongly recommend using a medium strength thread locking compound on the hex bolts to firmly secure the hoist.

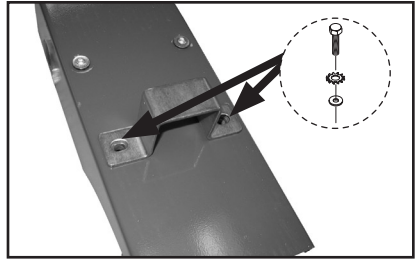

Figure 4. Mounting the hoist (pole not shown for clarity).

3. Firmly tighten the hex bolts and check to make sure the hoist does not swing or move on the pipe.

Mounting and Loading Hardware

When attaching hardware to the electric hoist:

- DO NOT attach multiple chains or harnesses directly to the hook. Only one point of contact should be used on the hook and shackle to lessen the chance of the load falling and to allow proper load alignment (**Figure 5**).
- DO NOT attach oversized items or harnesses directly to the hoist. Oversized loading hardware creates multiple points of contact and will not fit properly with the electric hoist's hardware. Uneven and dangerous loads may result.

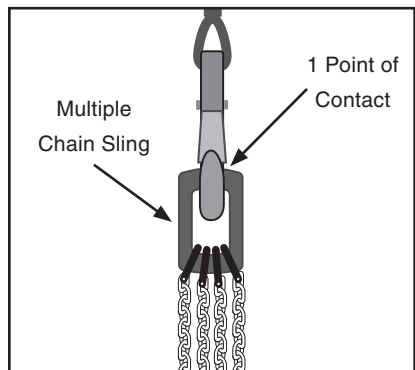

Figure 5. Example of proper hardware.

Test Run

The Model H0778/H0779 electric hoist has a safety stop microswitch that will automatically shut **OFF** the motor before the lift or pulley hook can be retracted into the housing.

If the hook is allowed to retract into the housing, the hoist will continue to pull the cable until the cable or cable hardware breaks, causing the load to drop and resulting in possible property damage/injury.

After mounting the hoist, the safety stop microswitch must be tested before lifting any loads.

To test run the hoist:

1. Plug the electric hoist into a grounded 110V outlet.
2. Grab the lift hook and pull it away from the hoist while using the control handle to lower the hoist cable a few feet by pressing the switch in the down position (**Figure 6**).

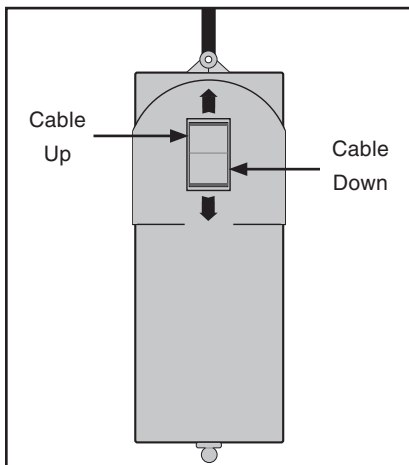

Figure 6. Controller.

3. Let go of the hook and move to a safe distance.
4. Use the control handle to fully retract the cable.
 - If the motor shuts **OFF** when the cable stop compresses the spacing rack (**Figure 7**), the safety stop microswitch feature is working correctly and the test run is complete.
 - If the motor does not shut **OFF** when the cable stop compresses the spacing rack, immediately release the UP/DOWN switch. This safety feature must work properly before proceeding with regular operations. Call Tech Support at (570) 546-9663 for assistance.

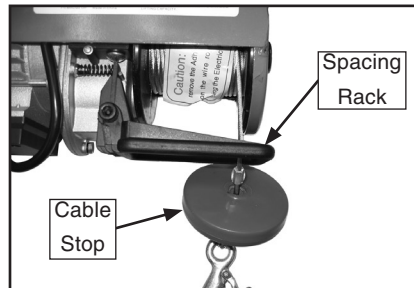

Figure 7. Safety stop mechanism.

!WARNING

Like all tools there is potential danger when operating this tool. Accidents can be caused by lack of familiarity or failure to pay attention. If normal safety precautions are overlooked or ignored, serious personal injury may occur.

SECTION 4: OPERATIONS

To use the electric hoist:

1. Plug the electric hoist into a grounded 110V outlet.
2. Grab the lift hook and pull it away from the hoist while using the control switch to lower the hoist cable by pressing the switch in the down position (Figure 6).

CAUTION

Never fully unwind the cable from the electric hoist. Always leave at least 3 turns of cable on the hoist spool to prevent the cable from detaching.

3. Verify the weight of the item to be hoisted. Review the **Machine Data** on **Page 2** to see if the operation can be completed with a single or doubled-back cable, as shown in **Figure 8**.

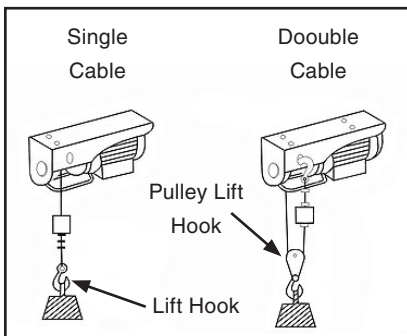

Figure 8. Cable options.

4. Securely attach the item being lifted by using the lift hook (for single cable use), or the pulley lift hook (for double cable use).

NOTICE

Never wrap the cable around the item being lifted and hook it onto the cable itself. Damage to the object and fraying of the cable can result.

5. Check that all bystanders are clear and that the item has a clear path of movement.
6. Use the control switch to retract the cable (Figure 6). Watch or have an assistant view the cable as it winds up on the hoist spool. To prevent damage to the hoist cable, make sure that the cable is wound evenly, as shown in **Figure 9**.

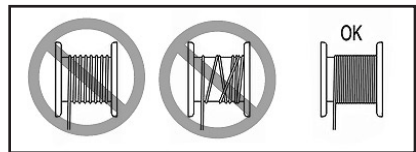

Figure 9. Proper cable winding.

CAUTION

No list of safety guidelines is complete, because every work environment is different. Always consider safety first and use common sense. Failure to use this tool with caution and respect could result in serious personal injury.

SECTION 5: MAINTENANCE

General

Check mounting hardware daily before use for cracks, unsafe wear, deformation, or warping. DO NOT attempt to fix the mounting hardware! Discard and replace all damaged mounting hardware. Check daily for loose pins, rings, screws, wires and safety latches. Tighten or replace any loose items. Check daily for damage or fraying along the length of the cable. Damaged or loose parts may cause the load to fall and may result in serious injury. Check that the microswitch is functioning daily before use.

Never leave a load or hoisting equipment on the hoist when not in use. This may cause excessive strain on the hoist and cable and may shorten the life of your hoist and cable.

If the hoist becomes dirty, wipe it down with a damp soft cloth and thoroughly dry all surfaces. DO NOT use solvents, chemicals, or other corrosive materials to clean the hoist.

Lubrication

Lightly oil the hoist cable with a light oil to inhibit rust and reduce friction, depending on frequency of use and environment. If the cable becomes wet during use, dry the cable and lightly oil before retracting the cable back onto the spool.

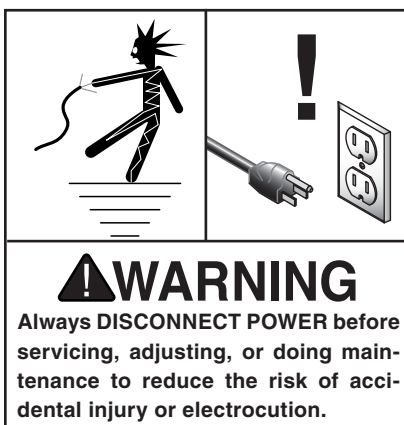

H0778 Breakdown

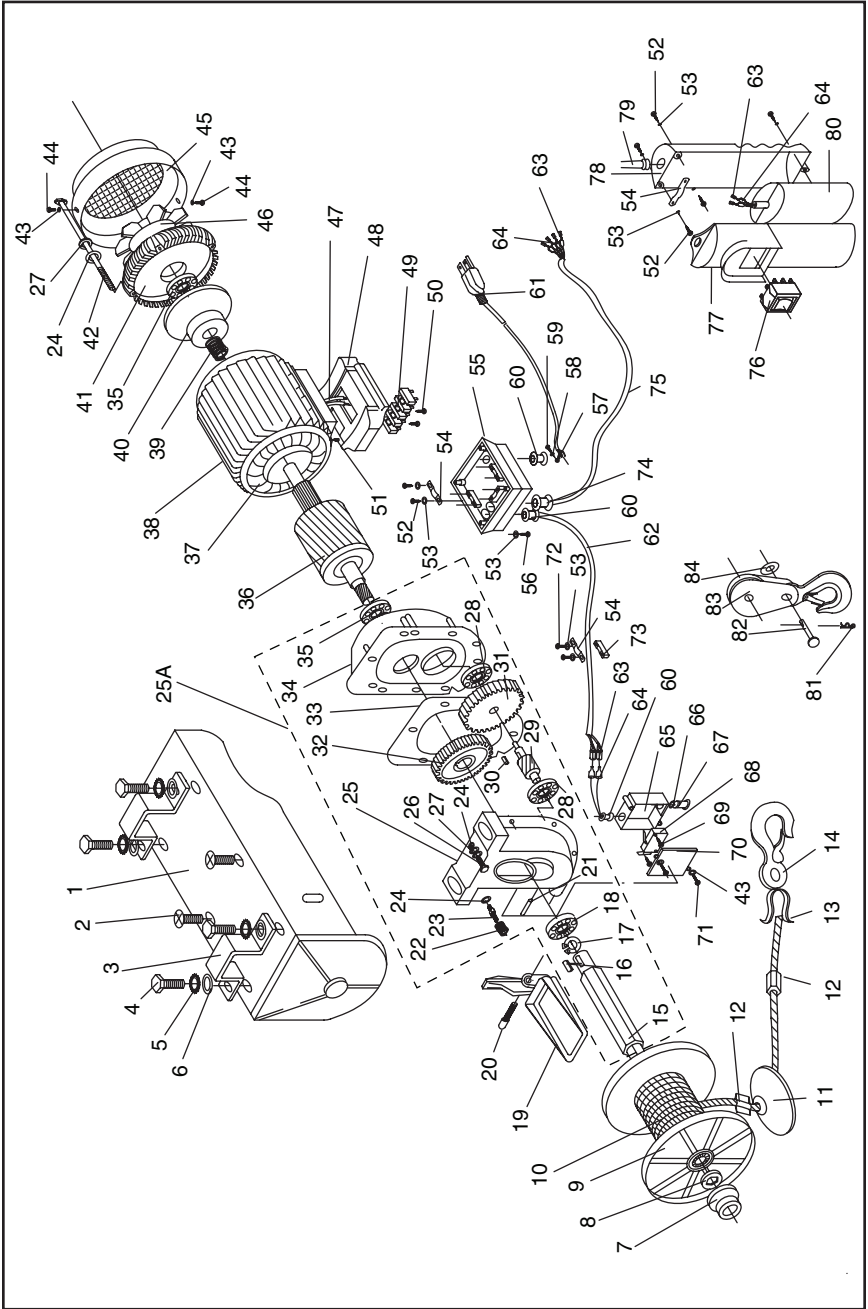

H0778 Parts List

REF PART #	DESCRIPTION	
1	PH0778001	BODY
2	PSB14M	CAP SCREW M8-1.25 X 20
3	PH0778003	MOUNTING BRACKET
4	PH0778004	HEX BOLT M8-1.25 X 25 G-8.8
5	PTLW07M	EXT TOOTH WASHER 8MM
6	PW01M	FLAT WASHER 8MM
7	PH0778007	SPOOL END
8	PH0778008	SPOOL WASHER
9	PH0778009	SPOOL FLANGE
10	PH0778010	CABLE
11	PH0778011	CABLE STOP
12	PH0778012	CABLE FASTENING SLEEVE
13	PH0778013	CABLE LOOP GUIDE
14	PH0778014	LIFT HOOK
15	PH0778025A	HOIST SPOOL
16	PK06M	KEY 5 X 5 X 10
17	PR05M	EXT RETAINING RING 15MM
18	P6202	BALL BEARING 6202ZZ
19	PH0778019	SPACING RACK
20	PSB45M	CAP SCREW M8-1.25 X 45
21	PRP42M	ROLL PIN 3 X 20
22	PH0778025A	COMPRESSION SPRING
23	PH0778025A	DOUBLE ENDED STUD
24	PW02M	FLAT WASHER 5MM
25	PH0778025A	GEAR BOX
25A	PH0778025A	GEAR BOX ASSEMBLY
26	PSB20M	CAP SCREW M5-.8 X 14
27	PLW01M	LOCK WASHER 5MM
28	P6200A	BALL BEARING 6200
29	PH0778025A	INTERMEDIATE SHAFT
30	PK06M	KEY 5 X 5 X 10
31	PH0778025A	GRADE 1 GEAR
32	PH0778025A	GRADE 2 GEAR
33	PH0778025A	GASKET
34	PH0778025A	FRONT COVER
35	P6202-2RS	BALL BEARING 6202 W/2 RS
36	PH0778036	ROTOR
37	PH0778037	STATOR
38	PH0778038	CHASSIS
39	PH0778039	COMPRESSION SPRING
40	PH0778040	BRAKE HOOP
41	PH0778041	GEAR COVER
42	PH0778042	HEX BOLT M5-.8 X 140

REF PART #	DESCRIPTION	
43	PW07M	FLAT WASHER 3MM
44	PS12M	PHLP HD SCR M3-.5 X 6
45	PH0778045	MOTOR FAN COVER
46	PH0778046	MOTOR FAN
47	PH0778047	CONNECTION CORDS
48	PH0778048	TOP CONNECTING HOUSING
49	PH0778049	TERMINAL BLOCK
50	PS59M	PHLP HD SCR M3-.5 X 14
51	PSB50M	CAP SCREW M5-.8 X 10
52	PH0778052	TAP SCREW M3.5 X 14
53	PW05M	FLAT WASHER 4MM
54	PH0778054	CLAMP PLATE
55	PH0778055	BOTTOM HOUSING
56	PS52M	PHLP HD SCR M4-.7 X 20
57	PH0778057	GROUNDING SHEET
58	PTLW01M	EXT TOOTH WASHER 4MM
59	PS07M	PHLP HD SCR M4-.7 X 8
60	PH0778060	STRAIN RELIEF LARGE
61	PH0778061	POWER CORD W/PLUG
62	PH0778062	MOTOR CORD
63	PH0778063	PLUG-IN SHEET
64	PH0778064	PLUG-IN SHEET SLEEVE
65	PH0778065	MICROSWITCH BOX
66	PR04M	EXT RETAINING RING 6MM
67	PH0778067	MICROSWITCH SHAFT
68	PH0778068	MICROSWITCH
69	PH0778069	TAP SCREW M2.4 X 14
70	PH0778070	MICROSWITCH COVER
71	PS34	PHLP HD SCR M3-.5 X 25
72	PHTEK28M	TAP SCREW M4 X 25
73	PH0778073	CORD CLIP
74	PH0778074	STRAIN RELIEF SMALL
75	PH0778075	REMOTE SWITCH CORD
76	PH0778076	UP/DOWN SWITCH
77	PH0778077	CONTROL SWITCH FRONT
78	PH0778078	CONTROL SWITCH BACK
79	PH0778079	CORD SHEATH
80	PC060A	CAPACITOR 60MFD 250VAC
81	PH0778081	HAIRPIN COTTER PIN 25 X 30
82	PH0778082	CLEVIS PIN 8 X 30
83	PH0778083	PULLEY HOOK ASSEMBLY
84	PW04M	FLAT WASHER 10MM

H0779 Breakdown

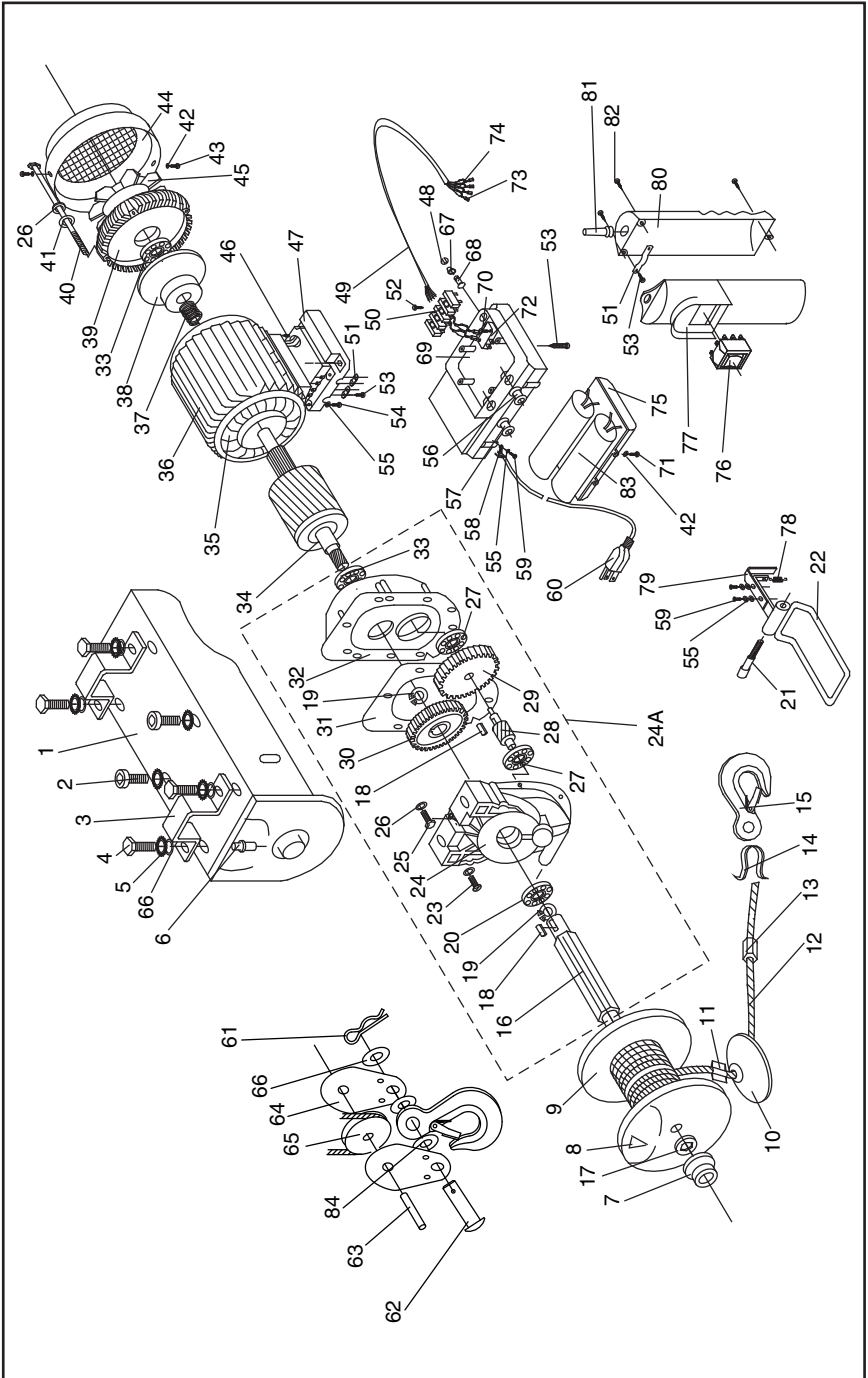

H0779 Parts List

REF PART #	DESCRIPTION	
1	PH0779001	BODY
2	PSB64M	CAP SCREW M10-1.5 X 25
3	PH0779003	MOUNTING BRACKET
4	PB01M	HEX BOLT M10-1.5 X 30
5	PTLW08M	EXT TOOTH WASHER 10MM
6	PH0779006	SPECIAL NUT
7	PH0779007	SPOOL END
8	PH0779008	WEDGE
9	PH0779009	SPOOL FLANGE
10	PH0779010	CABLE STOP
11	PH0779011	UPPER CABLE SLEEVE
12	PH0779012	CABLE
13	PH0779013	LOWER CABLE SLEEVE
14	PH0779014	CABLE LOOP GUIDE
15	PH0779015	LIFT HOOK
16	PH0779024A	HOIST SPOOL
17	PH0779017	SPOOL WASHER
18	PK10M	KEY 5 X 5 X 12
19	PR18M	EXT RETAINING RING 17MM
20	P6203	BALL BEARING 6203ZZ
21	PSB45M	CAP SCREW M8-1.25 X 45
22	PH0779022	SPACING RACK
23	PS40M	PHLP HD SCR M5-.8 X 16
24	PH0779024A	GEAR BOX
24A	PH0779024A	GEAR BOX ASSEMBLY
25	PSB24M	CAP SCREW M5-.8 X 16
26	PLW01M	LOCK WASHER 5MM
27	P6201	BALL BEARING 6201ZZ
28	PH0779024A	INTERMEDIATE SHAFT
29	PH0779024A	GRADE 1 GEAR
30	PH0779024A	GRADE 2 GEAR
31	PH0779024A	GASKET
32	PH0779024A	FRONT COVER
33	P6202	BALL BEARING 6202ZZ
34	PH0779034	ROTOR
35	PH0779035	STATOR
36	PH0779036	CHASSIS
37	PH0779037	COMPRESSION SPRING
38	PH0779038	BRAKE HOOP
39	PH0779039	MOTOR COVER
40	PH0779040	SPECIAL HEX BOLT
41	PW02M	FLAT WASHER 5MM
42	PW07M	FLAT WASHER 3MM

REF PART #	DESCRIPTION	
43	PS12M	PHLP HD SCR M3-.5 X 6
44	PH0779044	FAN COVER
45	PH0779045	MOTOR FAN
46	PSS03M	SET SCREW M6-1 X 8
47	PH0779047	TOP HOUSING
48	PR04M	EXT RETAINING RING 6MM
49	PH0779049	REMOTE SWITCH CORD
50	PH0779050	TERMINAL BLOCK
51	PH0779051	CLAMP PLATE
52	PH0779052	TAP SCREW M2.4 X 14
53	PHTEK2M	TAP SCREW M3.5 X 16
54	PS38M	PHLP HD SCR M4-.7 X 10
55	PW05M	FLAT WASHER 4MM
56	PH0779056	STRAIN RELIEF SMALL
57	PH0779057	STRAIN RELIEF LARGE
58	PH0779058	GROUNDING SHEET
59	PS07M	PHLP HD SCR M4-.7 X 8
60	PH0779060	POWER CORD W/PLUG
61	PH0779061	HAIRPIN COTTER PIN 25 X 30
62	PH0779062	CLEVIS PIN 10 X 35
63	PH0779063	CLAMP CONNECTOR
64	PH0779064	PULLEY CLAMP
65	PH0779065	PULLEY WHEEL
66	PW04M	FLAT WASHER 10MM
67	PH0779067	MICROSWITCH SHAFT SEAL
68	PH0779068	MICROSWITCH SHAFT
69	PH0779069	BOTTOM HOUSING
70	PH0779052	TAP SCREW M2.4 X 14
71	PH0779052	TAP SCREW M2.4 X 14
72	PH0779072	MICROSWITCH
73	PH0779073	PLUG-IN SHEET
74	PH0779074	PLUG-IN SHEET SLEEVE
75	PH0779075	HOUSING COVER
76	PH0779076	UP/DOWN SWITCH
77	PH0779077	CONTROL SWITCH FRONT
78	PH0779078	EXTENSION SPRING
79	PH0779079	LIMIT BRACKET
80	PH0779080	CONTROL SWITCH BACK
81	PH0779081	CORD SHEATH
82	PHTEK29M	TAP SCREW M3.5 X 20
83	PH0779083	CAPACITOR
84	PH0779084	SPACER

WARRANTY

Grizzly Industrial, Inc. warrants every product it sells for a period of **1 year** to the original purchaser from the date of purchase. This warranty does not apply to defects due directly or indirectly to misuse, abuse, negligence, accidents, repairs or alterations or lack of maintenance. This is Grizzly's sole written warranty and any and all warranties that may be implied by law, including any merchantability or fitness, for any particular purpose, are hereby limited to the duration of this written warranty. We do not warrant or represent that the merchandise complies with the provisions of any law or acts unless the manufacturer so warrants. In no event shall Grizzly's liability under this warranty exceed the purchase price paid for the product and any legal actions brought against Grizzly shall be tried in the State of Washington, County of Whatcom.

We shall in no event be liable for death, injuries to persons or property or for incidental, contingent, special, or consequential damages arising from the use of our products.

To take advantage of this warranty, contact us by mail or phone and give us all the details. We will then issue you a "Return Authorization Number," which must be clearly posted on the outside as well as the inside of the carton. We will not accept any item back without this number. Proof of purchase must accompany the merchandise.

The manufacturers reserve the right to change specifications at any time because they constantly strive to achieve better quality equipment. We make every effort to ensure that our products meet high quality and durability standards and we hope you never need to use this warranty.

Please feel free to write or call us if you have any questions about the machine or the manual.

Grizzly Industrial, Inc.
1203 Lycoming Mall Circle
Muncy, PA 17756
Phone: (570) 546-9663
Fax: (800) 438-5901

E-Mail:
techsupport@grizzly.com

Web Site: <http://www.grizzly.com>

Thank you again for your business and continued support. We hope to serve you again soon!



WARRANTY CARD

Name _____

Street _____

City _____ State _____ Zip _____

Phone # _____ Email _____ Invoice # _____

Model # _____ Order # _____ Serial # _____

The following information is given on a voluntary basis. It will be used for marketing purposes to help us develop better products and services. All information is strictly confidential.

1. How did you learn about us?

Advertisement Friend Catalog
 Card Deck Website Other: _____

2. Which of the following magazines do you subscribe to?

<input type="checkbox"/> Cabinet Maker	<input type="checkbox"/> Popular Mechanics	<input type="checkbox"/> Today's Homeowner
<input type="checkbox"/> Family Handyman	<input type="checkbox"/> Popular Science	<input type="checkbox"/> Wood
<input type="checkbox"/> Hand Loader	<input type="checkbox"/> Popular Woodworking	<input type="checkbox"/> Wooden Boat
<input type="checkbox"/> Handy	<input type="checkbox"/> Practical Homeowner	<input type="checkbox"/> Woodshop News
<input type="checkbox"/> Home Shop Machinist	<input type="checkbox"/> Precision Shooter	<input type="checkbox"/> Woodsmith
<input type="checkbox"/> Journal of Light Cont.	<input type="checkbox"/> Projects in Metal	<input type="checkbox"/> Woodwork
<input type="checkbox"/> Live Steam	<input type="checkbox"/> RC Modeler	<input type="checkbox"/> Woodworker West
<input type="checkbox"/> Model Airplane News	<input type="checkbox"/> Rifle	<input type="checkbox"/> Woodworker's Journal
<input type="checkbox"/> Modeltec	<input type="checkbox"/> Shop Notes	<input type="checkbox"/> Other: _____
<input type="checkbox"/> Old House Journal	<input type="checkbox"/> Shotgun News	

3. What is your annual household income?

\$20,000-\$29,000 \$30,000-\$39,000 \$40,000-\$49,000
 \$50,000-\$59,000 \$60,000-\$69,000 \$70,000+

4. What is your age group?

20-29 30-39 40-49
 50-59 60-69 70+

5. How long have you been a woodworker/metalworker?

0-2 Years 2-8 Years 8-20 Years 20+ Years

6. How many of your machines or tools are Grizzly?

0-2 3-5 6-9 10+

7. Do you think your machine represents a good value? Yes No

8. Would you recommend Grizzly Industrial to a friend? Yes No

9. Would you allow us to use your name as a reference for our customers in your area?

Note: *We never use names more than 3 times.* Yes No

10. Comments: _____

Send a Grizzly Catalog to a friend:

Name _____
Street _____
City _____ State _____ Zip _____

FOLD ALONG DOTTED LINE

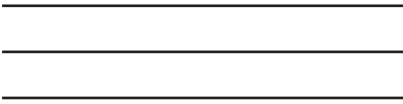

Place
Stamp
Here



GRIZZLY INDUSTRIAL, INC.
P.O. BOX 2069
BELLINGHAM, WA 98227-2069



TAPE ALONG EDGES--PLEASE DO NOT STAPLE