



Model EEDU and HEEDU Indoor/Power-Vented Duct Furnaces

REZNOR *Thomas & Betts*

INSTALLATION FORM RGM 421 (Version A)

APPLIES TO: Installation/Operation/Service

Table of Contents

	Paragraph No.	Page No.
Installation and Operation	1-26	1-20
Check Installation and Start-Up	27	21
Service/Maintenance/Troubleshooting	28-33	22-24

Index by Page Number

Air Flow Requirements	13	Coupling Two, Three, Four or Five Furnaces	7	Mounting the Furnace	6
Blower Connections	14	Dimensional Data	3	Pilot and Ignition Systems	20
Burner Air Adjustment	21	Disconnect Switch	15	Reversing Air Flow	6
Burner Rack Removal	22	Duct Connections	12	SERVICE	22
Burners	21	Operating Sequence	16	Start-Up	21
Bypass Duct	13	Optional Ductstat	19	Suspending the Furnace	6
Carryover System	21	Electrical Supply and Connections	15	Thermostat	15
Check Installation and Start-Up	21	Optional Electronic Modulation	20	Troubleshooting	23, 24
CHLORINES	5	Fan Control (Optional)	18	Optional Two-Stage Operation	19
Cleaning Pilot and Main Burners	22	Gas Piping and Pressures	8	Uncrating	4
Cleaning the Heat Exchanger	23	GENERAL	1	Valve	19
Clearances	4	HAZARD INTENSITY LEVELS	2	Venter	23
Combustion Air	4	Installation Codes	2	Venting	9
Combustion Air Proving Switch	15	Limit Switch	17	Warranty	2
Condensate Drain, Option CS1	13	MAINTENANCE	22	Wiring Diagrams	16-17

Reference: Replacement Parts Form, RGM 735

FOR YOUR SAFETY

If you smell gas:

1. Open windows.
2. Don't touch electrical switches.
3. Extinguish any open flame.
4. Immediately call your gas supplier.

FOR YOUR SAFETY

The use and storage of gasoline or other flammable vapors and liquids in open containers in the vicinity of this appliance is hazardous.

WARNING: Gas-fired appliances are not designed for use in hazardous atmospheres containing flammable vapors or combustible dust, in atmospheres containing chlorinated or halogenated hydrocarbons, or in applications with airborne silicone substances. See Hazard Levels, Page 2.

WARNING: Improper installation, adjustment, alteration, service, or maintenance can cause property damage, injury or death. Read the installation, operation, and maintenance instructions thoroughly before installing or servicing this equipment.

GENERAL

Installation should be done by a qualified agency in accordance with the instructions in this manual and in compliance with all codes and requirements of authorities having jurisdiction. The instructions in this manual apply to the duct furnace models shown on the right.

Model	Characteristics
EEDU	Indoor, Power-Vented, Standard CFM, 80% Thermal Efficient
HEEDU	Indoor, Power-Vented, High CFM, 80% Thermal Efficient

HAZARD INTENSITY LEVELS

- 1. DANGER:** Failure to comply will result in severe personal injury or death and/or property damage.
- 2. WARNING:** Failure to comply could result in severe personal injury or death and/or property damage.
- 3. CAUTION:** Failure to comply could result in minor personal injury and/or property damage.

1. Installation Codes

The duct furnaces covered in this manual are design-certified by the American Gas Association and approved by the Canadian Gas Association for use with either natural or propane gas. The type of gas for which the furnace is equipped and the correct firing rate are shown on the rating plate attached to the unit. Electrical characteristics are shown on both the motor nameplate and the unit rating plate.

These units must be installed in accordance with local building codes. In the absence of local codes, in the United States, the unit must be installed in accordance with the National Fuel Gas Code Z223.1a (latest edition). A Canadian installation must be in accordance with the CAN/CGA B149.1 and B149.2 Installation Code for Gas Burning Appliances and Equipment. These codes are available from CSA Information Services, 1-800-463-6727. Local authorities having jurisdiction should be consulted before installation is made to verify local codes and installation procedure requirements.

Clearances from the heater and vent to construction or material in storage must conform with the National Fuel Gas Code ANSI Z223.1a (latest edition) pertaining to gas-burning devices, and such material must not attain a temperature over 160°F by continued operation of the heater.

Special Installations (Aircraft Hangars/ Garages)

Installations in aircraft hangars should be in accordance with ANSI/NFPA No. 409 (latest edition), Standard for Aircraft Hangars; in public garages in accordance with ANSI/NFPA No. 88A (latest edition), Standard for Parking Structures; and for repair garages in accordance with ANSI/NFPA No. 88B (latest edition), Standard for Repair Garages. ANSI/NFPA-88 (latest edition) specifies overhead heaters must be installed at least eight feet above the floor. In Canada, installations in aircraft hangars should be in accordance with the requirements of the enforcing authorities, and in public garages in accordance with CAN/CGA B149 codes.

2. Warranty

Refer to limited warranty information on the warranty card in the "Owner's Envelope".

WARRANTY: Warranty is void if.....

- Furnaces are used in atmospheres containing flammable vapors or atmospheres containing chlorinated or halogenated hydrocarbons or any contaminant (silicone, aluminium oxide, etc.) that adheres to the spark ignition flame sensing probe.**
- Wiring is not in accordance with the diagram furnished with the heater.**
- Unit is installed without proper clearances to combustible materials or located in a confined space without proper ventilation and air for combustion. (See Paragraph 5.)**
- Furnace air throughput is not adjusted within the range specified on the rating plate.**



Thomas & Betts

3. Dimensions

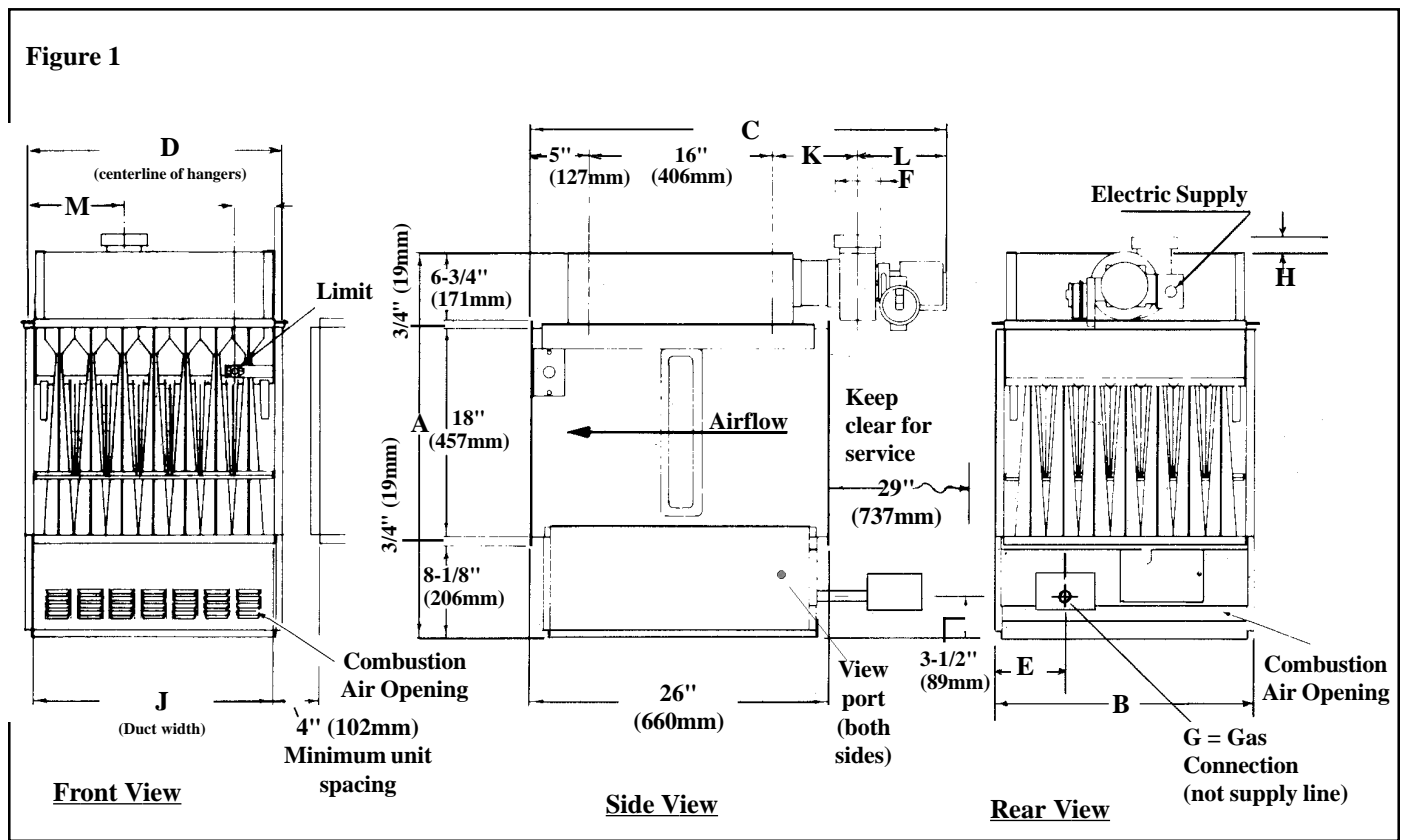

Dimensions (inches)

Size	A	B	C	D	E	F	G		H	J	K	L	M
							Nat	Pro					
75, 100	34-3/8	14-1/4	35-11/16	14-5/8	4-3/8	3-15/16	1/2	1/2	5/8	12-1/2	7-1/4	7-7/16	4-5/8
125, 140	34-3/8	17	35-11/16	17-3/8	4-3/8	3-15/16	1/2	1/2	5/8	15-1/4	7-1/4	7-7/16	6
170	34-3/8	19-3/4	35-11/16	20-1/8	4-3/8	3-15/16	1/2	1/2	5/8	18	7-1/4	7-7/16	7-3/8
200	34-3/8	22-1/2	35-11/16	22-7/8	4-3/8	3-15/16	1/2	1/2	5/8	20-3/4	7-1/4	7-7/16	8-3/4
225	34-3/8	25-1/4	35-11/16	25-5/8	4-3/8	4-15/16	1/2	1/2	1-3/8	23-1/2	7-1/4	7-7/16	10-1/8
250	34-3/8	28	35-11/16	28-3/8	7-1/8	4-15/16	1/2	1/2	1-3/8	26-1/4	7-1/4	7-7/16	11-1/2
300	34-3/8	33-1/2	38-1/8	33-7/8	9-7/8	5-15/16	3/4	1/2	1-3/8	31-3/4	9-9/16	7-5/8	13-7/8
350	34-3/8	39	38-1/8	39-3/8	12-5/8	5-15/16	3/4	1/2	1-3/8	37-1/4	9-9/16	7-5/8	16-5/8
400	34-3/8	44-1/2	38-1/8	44-7/8	15-3/8	5-15/16	3/4	1/2	1-3/8	42-3/4	9-9/16	7-5/8	19-3/8

Dimensions (mm)

Size	A	B	C	D	E	F	G		H	J	K	L	M
							Nat	Pro					
75, 100	873	362	906	371	111	100	13	13	16	318	184	189	117
125, 140	873	432	906	441	111	100	13	13	16	387	184	189	152
170	873	502	906	511	111	100	13	13	16	457	184	189	187
200	873	572	906	581	111	100	13	13	16	527	184	189	222
225	873	641	906	651	111	125	13	13	35	597	184	189	257
250	873	711	906	721	181	125	13	13	35	667	184	189	292
300	873	851	968	860	251	151	19	13	35	806	243	194	352
350	873	991	968	1000	321	151	19	13	35	946	243	194	422
400	873	1130	968	1140	391	151	19	13	35	1086	243	194	492

4. Uncrating and Preparation

This furnace was test operated and inspected at the factory prior to crating and was in operating condition. If the furnace has incurred any damage in shipment, file a claim with the transporting agency.

CAUTION: Remove the panel from the bottom rear of the furnace (See Paragraph 28) and check the burner rack assembly. The burner rack "drawer" should be setting level with each side on a support rail. Check to assure that EXCESSIVE shipping vibration has not caused the burner rack assembly to "drop off" the support rails into the bottom pan. If the burner rack assembly is positioned properly, close the back panel. If the burner rack has fallen, remove the screws holding the burner rack assembly and pull out the burner rack "drawer". Re-assemble by sliding the burner rack "drawer" into the heater, being sure that both sides are resting on the support rails. Re-attach to the support brackets underneath the burners. Re-insert the burner rack screws and close the back panel.

Check the rating plate for the gas specifications and electrical characteristics of the furnace to be sure that they are compatible with the gas and electric supplies at the installation site. Read this booklet and become familiar with the installation requirements of your particular furnace. If you do not have knowledge of local requirements, check with the local gas company or any other local agencies who might have requirements concerning this installation. Before beginning, make preparations for necessary supplies, tools, and manpower.

Check to see if there are any field-installed options that need to be assembled to the furnace prior to installation.

Option Parts -- Some gas control options will have parts either shipped loose with the heater or shipped separately. If your unit is equipped with any of the following gas control options, be sure these parts are available at the job site.

Heating -- Gas Control Option	Option AG7 Amplifier, P/N 48035 Thermostat, P/N 48033
Makeup Air -- Gas Control Options	Option AG3 Control Switch, P/N 29054 Gasket, P/N 7726 Gasket Retainer Plate, P/N 7727
(All of these options also require a shipped-separate fan control, Opt CQ1 (P/N 57960), which should be at the job site.	Option AG8 Temperature Sensor, P/N 48041 Amplifier, P/N 48037 Control Switch, P/N 29054
	Option AG9 Remote Temperature Selector, P/N 48042 Temperature Sensor, P/N 48041 Amplifier, P/N 48035 Control Switch, P/N 29054
	Option AG15 or AG16 Remote Temperature Selector, P/N 115848 Stage Adder Module, P/N 115849 Control Switch, P/N 29054 Transformer 115 to 24V, P/N 103055 or 208/230 to 24V, P/N 103497; and 1/2" locknut, P/N 16222 (for transformer)
	Display Module, P/N 115852 (AG16 only)

Other shipped-separate options could include a gas shutoff valve, a condensate drain fitting, a thermostat, a hanger kit, a coupling kit, a fan control, or high temperature sealing tape.

5. Location, Clearances, and Combustion Air

Unit must be installed so that the following clearances are provided for combustion air space, service and inspection, and for proper spacing from combustible construction.

NOTE: See Figure 5 for service clearance illustration.

REQUIRED CLEARANCES					
Front	Top	Flue Connector	Sides	Bottom	Rear
6"	6"	6"	6"	12"	29"
152mm	152mm	152mm	152mm	305mm	737mm

CAUTION: Do not locate heater where it may be exposed to liquid spray, rain or dripping water.

These duct furnaces are designed to take combustion air from the space in which the furnace is installed. The air that enters into the combustion process is vented to the outdoors. Sufficient air must enter the equipment location to replace the air exhausted through the vent system. Modern construction methods involve the greater use of insulation, improved vapor barriers and weather-stripping, with the result that buildings generally are much tighter structurally than they have been in the past. The combustion air supply for gas-fired equipment can be affected by these construction conditions because infiltration that would have existed in the past may not be adequate. Extensive use of exhaust fans aggravates the situation. In the past the filtration of outside air assumed in heat loss calculations (one air change per hour) was assumed to be sufficient. However, current construction methods may now require the introduction of outside air through wall openings or ducts.

WARNING: These furnaces are designed to take combustion air from the space in which the unit is installed and are not designed for connection to outside combustion air intake ducts. Use of outside air ducts voids the warranty and could cause hazardous operation. (See Hazard Levels, page 2.)

Requirements for combustion air and ventilation air depend upon whether the unit is located in a confined or unconfined space. An "unconfined space" is defined as a space whose volume is not less than 50 cubic feet per 1000 BTUH of the installed appliance. Under all conditions, enough air must be provided to ensure there will not be a negative pressure condition within the equipment room or space. A positive seal must be made in all return-air connections and ducts. Even a slight leak can create a negative pressure condition in a confined space and affect combustion.

Installation in a Confined Space

Figure 2 - Confined Space: A space whose volume is less than 50 cubic feet per 1000 BTUH of the installed appliance input rating

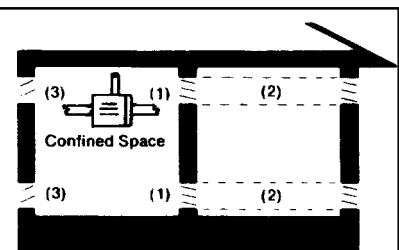

Do not install a unit in a confined space without providing wall openings leading to and from the space. Provide openings near the floor and ceiling for ventilation and air for combustion as shown in Figure

2, depending on the combustion air source as noted in Items 1, 2, and 3 below the illustration.

Add total BTUH of all appliances in the confined space and divide by figures below for square inch free area size of each (top and bottom) opening.

1. Air from inside the building -- openings 1 square inch free area per 1000 BTUH. Never less than 100 square inches free area for each opening. See (1) in Figure 2.

2. Air from outside through duct -- openings 1 square inch free area per 2000 BTUH. See (2) in Figure 2.

3. Air direct from outside -- openings 1 square inch free area per 4000 BTUH. See (3) in Figure 2.

NOTE: For further details on supplying combustion air to a confined space, see the National Fuel Gas Code ANSI Z223.1a (latest edition).

Hazards of Chlorines

The presence of chlorine vapors in the combustion air of gas-fired heating equipment presents a potential corrosion hazard. Chlorine will, when exposed to flame, precipitate from the compound, usually freon or degreaser vapors, and go into solution with any condensation that is present in the heat exchanger or associated parts. The result is hydrochloric acid which readily attacks all metals including 300 grade stainless steel.

Care should be taken to separate these vapors from the combustion process. This may be done by wise location of the furnace with regard to exhausters or prevailing wind direction. Remember, chlorine is heavier than air. This fact should be kept in mind when determining installation locations of heating equipment and building exhaust systems.

6. Instructions for Reversing Air Flow by Changing Directional Air Baffles in the Heat Exchanger

Duct furnaces are equipped with directional air baffles between the heat exchanger tubes. Facing the control compartment of the furnace, the standard direction of air flow is from the rear of the furnace (gas valve location) toward the front of the furnace. If the installation site requires air flow from the front to the rear, the unit may be field adapted by re-locating the limit control and reversing the position of the directional air baffles.

Instructions:

NOTE: If the unit has optional outer side panels, locate the limit control and remove the outer panel on that side of the furnace.

1. All Models - Refer to Figure 3A. Remove the screws attaching the limit control bracket to the side of the furnace. Carefully pull the bracket/control assembly through the hole. (Do not disconnect wires.)

2. All EEDU Models (see below for high CFM HEEDU Models) - Refer to Figure 3B and follow Steps a)-d) below to reverse the direction of the baffles.

- Remove Screws "A". Individually lift each baffle slightly and slide forward. Remove all baffles completely from the heat exchanger.
- Remove Screws B and the top baffle support assembly. Re-position the assembly on the opposite end of the heat exchanger and attach.
- Remove Screws C and the assembled bottom baffle support and brackets. Plug the holes in the heat exchanger bottom by re-inserting the screws in the holes. Position the assembly on the opposite end of the heat exchanger and attach using field-supplied sheet metal screws.
- Re-install all of the individual baffles by reversing procedure in Step a) above.

Figure 3A - Limit Control Location - When reversing air flow, the limit control must be re-located. The limit control MUST be on the discharge end of the heat exchanger

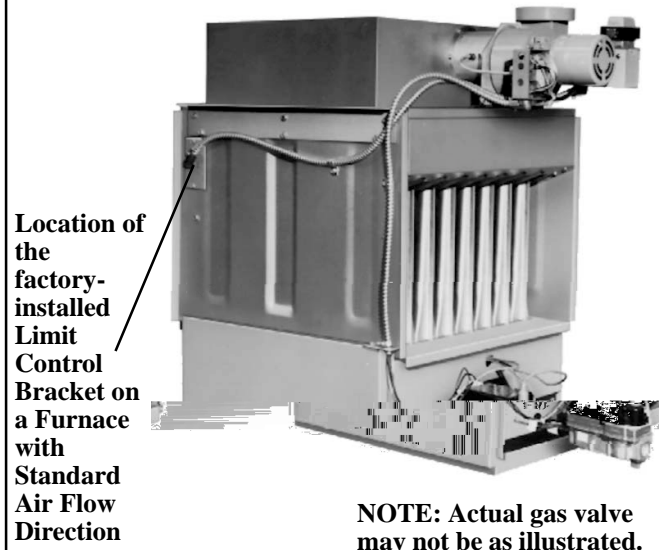
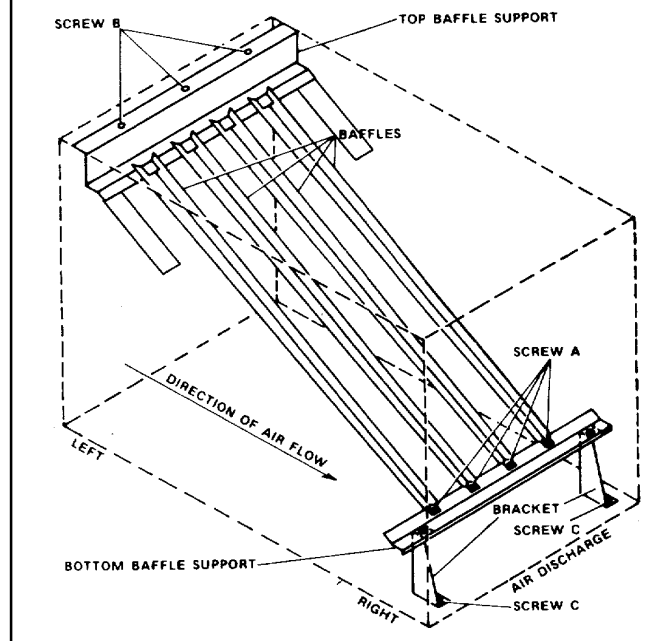

Figure 3B - Model EEDU has a top and bottom support assembly and individual baffles.



All HEEDU Models (see above for EEDU Models) - Refer to Figure 3C and follow Steps a) and b) below to move the top baffle to the entering air end of the heater exchanger.

- Remove screws B and the baffle.
- Re-position the baffle on the "entering air" end of the heat exchanger and attach.

6. Instructions for Reversing Air Flow (cont'd)

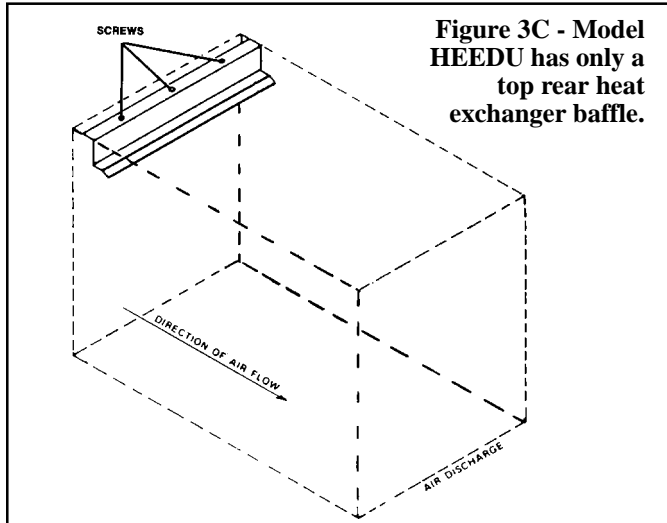

3. All Models - Relocate the limit control.

- a) At the discharge end on the same side of the heat exchanger, measure down 4-1/2" and in 1-11/16". Using that point as the center, punch a 2-1/4" diameter hole in the side panel.

NOTE: It may be necessary to move cable connections. Re-insert screws to plug all holes in the side panel. After the limit control is installed, the cable connections may be re-attached using field-supplied sheet metal screws.

- b) With the limit control on the heat exchanger side of the bracket, slide the limit control/bracket assembly into the hole. Attach the bracket with two sheet metal screws.
- c) Cover all of the original factory-made limit control holes with a field-supplied sheet metal plate. Do not leave any open holes in the side panel or the heat exchanger bottom.

4. The furnace is now ready for installation with the air flow from front to rear (gas valve side).

7. Suspending or Mounting the Furnace

Before installing the furnace, check the supporting structure to be used to verify that it has sufficient load-carrying capacity to support the weight of the unit.

		Net Weight									
Size	75	100	125	140	170	200	225	250	300	350	400
Lbs	104	104	126	128	150	172	194	216	262	306	328

Suspending the Furnace

The furnace is provided with four 15/32" diameter holes to provide four-point suspension. To suspend the unit, cut lengths of 7/16"-16 threaded rod to provide unit height. See Figure 4A for details. NOTE: A hanger adapter kit Option CK3 is available to facilitate suspension. See Figure 4B.

WARNING: Units must be level for proper operation. Do not place or add additional weight to the suspended furnace. See Hazard Levels, page 2.

Figure 4A - Suspending a Single Furnace

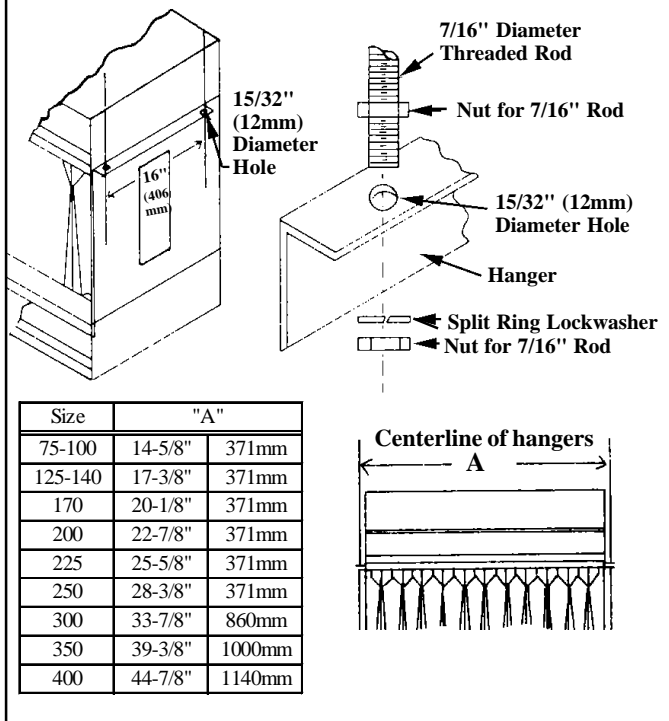
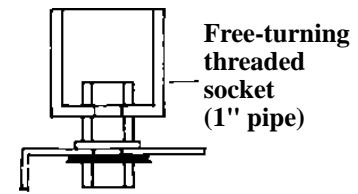

Figure 4B - Option CK3 Hanger Kit (P/N 57959) with four threaded sockets



Mounting the Furnace

Change position of the hanger bracket as shown in Figure 5. When the furnace is mounted on combustible material, a minimum clearance of 12" is required.

Figure 5 - Base Mounted Furnace

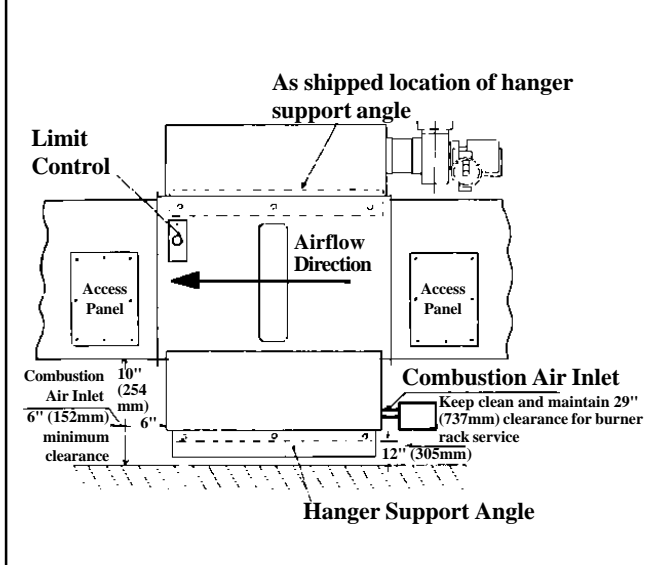

8. Coupling Two, Three, Four or Five Furnaces using Optional Coupling Kits

Refer to illustrations and follow the instructions below.

Coupling Kit, Option CR1 (P/N 57963), for Two Furnaces		
Qty	P/N	Description
2	57964	Filler Plate
1	57965	Tie Plate
2	9557	Threaded Socket Assembly
2	5095	3/8-16 x 1-1/4" lg Hex Head Bolts
2	5197	Split Ring Lock Washer
20	11813	#10 x 1/2" lg Sheetmetal Screws

Additional Kits:
 3 Furnaces - Option CR2 (P/N 82654)
 4 Furnaces - Option CR3 (P/N 82655)
 5 Furnaces - Option CR4 (P/N 82656)

Figure 6A - Coupling Furnaces

Item	Description
1	Socket Assembly
2	Bolt
3	Lockwasher
5	Spotweld Nut
6	Tie Plate
7	Hanger Angles

Figure 6B - Installing Coupling Kit Tie Plate

Instructions for Coupling Furnaces (Refer to Figures 6A, 6B, 6C and 6D)

1. Attach the tie plate to the first furnace using threaded socket assemblies. Tie plate must be positioned below the hanger angles. Secure fasteners firmly.
2. Move the second furnace into position next to the first furnace. Tie plate must be below the hanger angle. Secure the tie plate to the hanger angle using the 3/8-16 bolts, the washers, and the spotweld nuts on the tie plate.
3. Position the filler plates to furnaces as shown in Figure 6A. Using a filler plate as a template, drill 1/8" diameter holes. Attach filler plates using the sheet metal screws provided. Offset of filler plate allows alignment with unit duct flanges. See Figure 6C.
4. Coupled units require access panels in the top or bottom of the outlet duct for limit control service. See Figure 6D and Paragraph 11.

Size	"A"	
75-100	14-5/8"	371mm
125-140	17-3/8"	371mm
170	20-1/8"	371mm
200	22-7/8"	371mm
225	25-5/8"	371mm
250	28-3/8"	371mm
300	33-7/8"	860mm
350	39-3/8"	1000mm
400	44-7/8"	1140mm

Figure 6C - Front View of Coupled Furnaces

Figure 6D - Top View of Coupled Furnaces (NOTE: Access panel may be in top or bottom of ductwork.)

9. Gas Piping and Pressures

WARNING: This appliance is equipped for a maximum gas supply pressure of 1/2 pound, 8 ounces, or 14 inches water column. Supply pressure higher than 1/2 pound requires installation of an additional service regulator external to the unit.

PRESSURE TESTING SUPPLY PIPING

Test Pressures Above 1/2 PSI: Disconnect the heater and manual valve from the gas supply line which is to be tested. Cap or plug the supply line.

Test Pressures Below 1/2 PSI: Before testing, close the manual valve on the heater.

All piping must be in accordance with requirements outlined in the National Fuel Gas Code ANSI/Z223.1a (latest edition), published by the American Gas Association or CAN/CGA-B149.1 and B149.2, published by the Canadian Gas Association (See Paragraph 1). Gas supply piping installation should conform with good practice and with local codes.

Duct furnaces for natural gas are orificed for operation with gas having a heating value of 1000 (+ or - 50) BTUH per cubic ft. If the gas at the installation does not meet this specification, consult the factory for proper orificing.

Pipe joint compounds (pipe dope) shall be resistant to the action of liquefied petroleum gas or any other chemical constituents of the gas being supplied.

WARNING: All components of a gas supply system must be leak tested prior to placing equipment in service. NEVER TEST FOR LEAKS WITH AN OPEN FLAME. Failure to comply could result in personal injury, property damage or death.

Install a ground joint union and manual shut-off valve upstream of the unit control system, as shown in Figure 7. The 1/8" plugged tapping in the shut-off valve provides connection for supply line pressure test gauge. The National Fuel Gas Code requires the installation of a trap

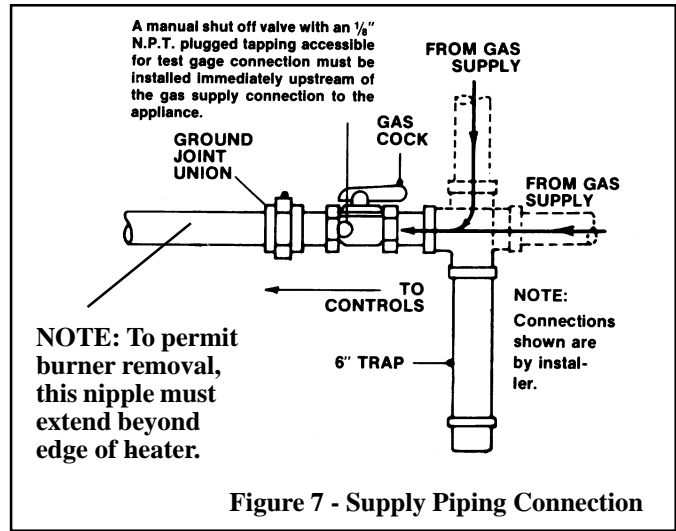

Figure 7 - Supply Piping Connection

with a minimum 3" drip leg. Local codes may require a minimum drip leg longer than 3" (typically 6").

Gas connection sizes are included in the Dimensional Tables in Paragraph 3. After all connections are made, disconnect the pilot supply at the control valve and bleed the system of air. Reconnect the pilot line and leak-test all connections by brushing on a soap solution.

Gas Connection to Single-Stage Valve (Not Gas Supply Line Size)		
Unit Size	75-250	300-400
Natural Gas	1/2"	3/4"
Propane Gas	1/2"	1/2"

Manifold or Orifice Pressure Settings

Measuring manifold gas pressure cannot be done until the heater is in operation. It is included in the steps of the "Check-Test-Start" procedure in Paragraph 24. The following warnings and instructions apply.

WARNING: Manifold gas pressure must never exceed 3.5" w.c. for natural gas and 10" w.c. for propane gas.

Capacity of Piping												
Cubic Feet per Hour based on 0.3" w.c. Pressure Drop												
Specific Gravity for Natural Gas -- 0.6 (Natural Gas -- 1000 BTU/Cubic Ft)												
Specific Gravity for Propane Gas -- 1.6 (Propane Gas -- 2550 BTU/Cubic Ft)												
Length of Pipe	Diameter of Pipe											
	1/2"		3/4"		1"		1-1/4"		1-1/2"		2"	
	Natural	Propane	Natural	Propane	Natural	Propane	Natural	Propane	Natural	Propane	Natural	Propane
20'	92	56	190	116	350	214	730	445	1100	671	2100	1281
30'	73	45	152	93	285	174	590	360	890	543	1650	1007
40'	63	38	130	79	245	149	500	305	760	464	1450	885
50'	56	34	115	70	215	131	440	268	670	409	1270	775
60'	50	31	105	64	195	119	400	244	610	372	1105	674
70'	46	28	96	59	180	110	370	226	560	342	1050	641
80'	43	26	90	55	170	104	350	214	530	323	990	604
90'	40	24	84	51	160	98	320	195	490	299	930	567
100'	38	23	79	48	150	92	305	186	460	281	870	531
125'	34	21	72	44	130	79	275	168	410	250	780	476
150'	31	19	64	39	120	73	250	153	380	232	710	433
175'	28	17	59	36	110	67	225	137	350	214	650	397
200'	26	16	55	34	100	61	210	128	320	195	610	372

Note: When sizing supply lines, consider possibilities of future expansion and increased requirements. Refer to National Fuel Gas Code for additional information on line sizing.

For Natural Gas: Manifold gas pressure is regulated by the combination valve to 3.5" w.c. Inlet pressure to the valve must be a minimum of 5" w.c. or as noted on the rating plate and a maximum of 14" w.c.

For Propane Gas: Manifold gas pressure is regulated by the combination valve to 10" w.c. Inlet pressure to the valve must be a minimum of 11" w.c. and a maximum of 14" w.c. Before attempting to measure or adjust manifold gas pressure, the inlet (supply) pressure must be within the specified range for the gas being used both when the heater is in operation and on standby. Incorrect inlet pressure could cause excessive manifold gas pressure immediately or at some future time.

Instructions for Checking Manifold Pressure:

1) With the manual valve (on the combination valve) positioned to prevent flow to the main burners, connect a manometer to the 1/8" pipe outlet pressure tap in the valve. NOTE: A manometer (fluid-filled gauge) is recommended rather than a spring type gauge due to the difficulty of maintaining calibration of a spring type gauge.

2) Open the valve and operate the heater. Measure the gas pressure to the manifold. Normally adjustments should not be necessary to the factory preset regulator. If adjustment is necessary, set pressure to correct settings by turning the regulator screw IN (clockwise) to increase pressure. Turn regulator screw OUT (counter-clockwise) to decrease pressure.

Consult the valve manufacturer's literature provided with the furnace for more detailed information.

10. Venting

WARNING: Failure to provide proper venting could result in death, serious injury, and /or property damage. Unit must be installed with a flue connection and proper vent to the outside of the building. Follow installation codes listed in Paragraph 1 and all venting instructions. Safe operation of any gas-fired equipment requires a properly operating vent system, correct provision for combustion air (See Paragraph 5) and regular maintenance and inspection. See Hazard Levels, page 2.

Venting must be in accordance with the National Fuel Gas Code Z223.1 or CAN/CGA B149.1 and B149.2, Installation Code for Gas Burning Appliances and Equipment, and all local codes. Local requirements supersede national requirements.

These power-vented units are designed to operate safely and efficiently with either a horizontal or vertical vent. (Horizontal vent run is recommended for maximum fuel savings.) Use either vent pipe approved for a Category III heater or appropriately sealed single-wall pipe. Or, if at least half of the equivalent length of the vent system is vertical, vent pipe approved for a Category I heater may be used. A vent cap of a type approved for use with this heater is required. If a vent cap is shipped with the heater, it is packaged attached to the venter housing. Detach the vent cap from the housing.

WARNING: Units installed in multiples require individual vent pipe runs and vent caps. Manifolding of vent runs is not permitted due to possible recirculation of combustion products into the building and possible back pressure effects on the combustion air proving switch.

Comply with the specific requirements and instructions in the following paragraphs.

Specific Venting Requirements (read all before installing)

1. Venter (Flue) Outlet

Size	Venter Outlet Diameter
75 - 200	4"
225 - 250	5"
300 - 400	6"

Venter Outlet Attachment Requirements:

- If the pipe used in the vent run is larger than the diameter of the venter outlet (See Vent Length Table 2), make the transition at the venter outlet.
- The venter is factory-installed as illustrated in Figure 8A. If required, the venter housing may be rotated as shown in Figure 8B. The vent may be run in either of the three directions as indicated by 1, 2, and 3 in the illustrations. Follow the instructions to rotate the venter housing.

Figure 8A - Factory-Installed Position of the Venter Housing

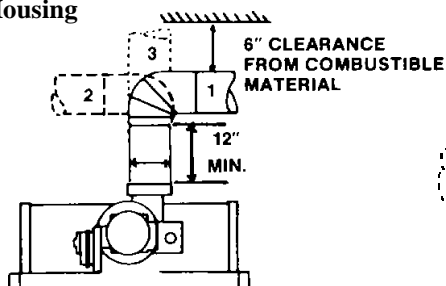
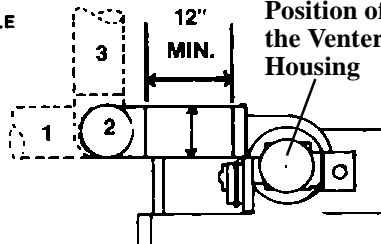

Figure 8B - Alternate Position of the Venter Housing



WARNING: Only the venter housing may be rotated. The motor and combustion air proving switch MUST remain as received from the factory. Unsafe or improper operation will result if the standard position is varied. See Paragraph 16 for explanation of combustion air proving switch.

Instructions for Rotating Venter Housing

1. Remove the three screws that attach the venter housing to the outlet duct (pipe from furnace to the venter). The assembly will remain in place.
2. Remove the three screws holding the motor plate to the venter housing. Holding the motor, rotate the venter housing to the alternate position (Figure 8B). Re-attach the motor plate to the housing. (To ensure correct venter wheel alignment, pre-punched holes are provided in the motor plate.)
3. Using the holes in the venter housing as a template, drill three 1/8" diameter holes in the outlet duct. Re-attach the venter housing to the outlet duct using the three screws removed in Step 1. Rotation is complete.

10. Venting (cont'd)

Specific Venting Requirements (read all before installing) (cont'd)

1. Venter (Flue) Outlet (cont'd)

Venter Outlet Attachment Requirements (cont'd):

- ☐ A minimum of 12" of straight pipe is required at the venter outlet (or transition fitting) before installing an elbow in the vent system. An elbow should never be attached directly to the venter.

2. Vent Pipe

If installed with a horizontal vent run, use either vent pipe approved for a Category III heater or appropriately sealed 26-gauge galvanized steel or equivalent single-wall pipe. If at least half of the equivalent length of the vent system is vertical, vent pipe approved for a Category I heater may be used. Single-wall pipe or double-wall (Type B) vent pipe are suitable for use with a Category I heater.

Use only one of the flue pipe diameters listed in the Vent Length Tables for the furnace size being installed.

3. Vent Length Tables

Size	Vent Pipe Diameter (inches)	Maximum Vent Length (see Note 1 below)	Equivalent Straight Length* - ft (M)	
			90° Elbow	45° Elbow
75	4	40 ft (12.2 M)	6 (1.8)	3 (.9)
100	4	50 ft (15.2 M)	7 (2.1)	3.5 (1.1)
125	4	50 ft (15.2 M)	7 (2.1)	3.5 (1.1)
140	4	50 ft (15.2 M)	7 (2.1)	3.5 (1.1)
170	4	50 ft (15.2 M)	7 (2.1)	3.5 (1.1)
200	4	50 ft (15.2 M)	7 (2.1)	3.5 (1.1)
225	5	50 ft (15.2 M)	9 (2.7)	4.5 (1.4)
250	5	50 ft (15.2 M)	9 (2.7)	4.5 (1.4)
300	6	50 ft (15.2 M)	11 (3.4)	5.5 (1.7)
350	6	50 ft (15.2 M)	11 (3.4)	5.5 (1.7)
400	6	50 ft (15.2 M)	11 (3.4)	5.5 (1.7)

*Reduce the maximum vent length by the amount indicated for each elbow used.

Size	Vent Pipe Diameter (inches)	Maximum Vent Length (see Note 1 below)	Equivalent Straight Length* - ft (M)	
			90° Elbow	45° Elbow
170	5	60 ft (18.3 M)	9 (2.7)	4.5 (1.4)
200	5	70 ft (21.3 M)	9 (2.7)	4.5 (1.4)
225	6	70 ft (21.3 M)	11 (3.4)	5.5 (1.7)
250	6	70 ft (21.3 M)	12 (3.7)	6 (1.8)
300	7	70 ft (21.3 M)	13 (4.0)	6.5 (2.0)
350	7	80 ft (24.3 M)	13 (4.0)	6.5 (2.0)
400	7	90 ft (27.4 M)	14 (4.3)	7 (2.1)

*Reduce the maximum vent length by the amount indicated for each elbow used.

NOTE 1: If the system contains all vertical pipe or a combination of vertical and horizontal vent pipe, the Maximum Permissible Vent Length shown in Tables 1 and 2 may be increased one foot for each foot of vertical pipe, up to a maximum increase of 10 feet for Model Sizes 75 - 125 and up to 20 feet for Model Sizes 140 - 400.

4. Vent System Joints - Vent system joints depend on the installation and the type of pipe being used.

If installed as a Category III heater (required if more than half of the equivalent length of the vent system is horizontal) **and single-wall vent pipe is being used**, use at least two non-corrosive screws per vent pipe joint and **seal all joints** to prevent leakage of flue gases into the building. For sealing joints, the use of Aluminum or TEFLON® (trademark of DuPont Corporation) tape suitable for 550°F is recommended (required in California). Vent tape of this type is available from the heater manufacturer as P/N 98266.

If installed as a Category III heater (required if more than half of the equivalent length of the vent system is horizontal) **and vent pipe specifically approved for Category III vent systems is being used**, follow the pipe manufacturer's instructions for proper sealing.

If installed with a Category I vent system (allowed only if at least half of the equivalent length of the vent system is vertical), use at least two non-corrosive screws per vent pipe joint on single-wall pipe or follow the pipe manufacturer's instructions for joining double-wall pipe.

5. Vent System Support - Support lateral runs every six feet, using a non-combustible material such as strap steel or chain. Do not rely on the heater for support of either horizontal or vertical vent pipe.

6. Condensation - Single wall vent pipe exposed to cold air or run through unheated areas must be insulated. Where extreme conditions are anticipated, install a means of condensate disposal.

7. Vent Terminal (Pipe and Vent Cap) - The vent system must be terminated with a suitable vent cap that is the same size as the vent run. Heaters with an A.G.A. rating plate that are ordered with an optional vent cap and all heaters with a C.G.A. rating plate have a vent cap packaged with the heater. If the "standard" size (Vent Length Table 1) of vent pipe is used, install the vent cap provided. If a vent cap is not included or if a non-standard size (Vent Length Table 2) of vent pipe is used, a field-provided cap must be used. If the vent cap is field-supplied, use a Type L Breidert *Air-x-hauster*® or equivalent vent cap. (Type L *Air-x-hauster*® is a trademark of The G. C. Breidert Company.) Use of a vent cap supplied by the pipe manufacturer is not permitted; the vent cap must be the type approved for use with this heater. A different style vent cap could cause nuisance problems or unsafe conditions.

See the illustrations in Figures 9 and 10 for requirements of both vertical and horizontal vent termination. The vent terminal section may be either single-wall or double-wall (Type B) vent pipe.

If double-wall pipe is used in the vent terminal, follow the instructions below to attach the vent cap and to connect the double-wall pipe to the single-wall vent pipe run.

INSTRUCTIONS FOR DOUBLE WALL PIPE INSTALLATION: Material Required: Double wall (Type B) Vent Pipe (**Note:** Using only one piece of vent pipe is recommended.); a thimble designed for double wall pipe (if construction is combustible); six 3/4" long sheetmetal screws; the vent cap; and a tube of silicone sealant

Instructions to attach VENT CAP to DOUBLE WALL (Type B) VENT TERMINAL

Look for the "flow" arrow on the vent pipe. Attach the vent cap to the "exhaust" end of the double wall pipe.

- 1) Slide the vent cap inside the pipe.
- 2) Drill a hole through the pipe and the vent cap. (Hole should be slightly smaller than the sheet metal screw being used.) Using a 3/4" long sheet metal screw, attach the cap to the pipe.
- 3) Repeat Step 2) drilling and inserting two additional screws evenly spaced (120° apart) around the pipe.

Instructions to connect the SINGLE WALL VENT system to a DOUBLE WALL (Type B) VENT TERMINAL:

- 1) Slide the single wall pipe inside the inner wall of the double-wall terminal pipe.
- 2) Drill a hole through both walls of the double wall pipe and the single wall pipe. (Hole should be slightly smaller than the sheet metal screws being used.) Using a 3/4" long sheet metal screw, attach the two pieces of pipe. Do not overtighten.

- 3) Repeat Step 2) drilling and inserting two additional screws evenly spaced (120° apart).
- 4) To seal the annular opening (the gap between the single and double wall pipe), run a large bead of silicone sealant in the opening. The bead of sealant must be large enough to seal the opening, but it is not necessary to fill the full volume of the annular area.

Figure 9 - Vertical Vent Terminal

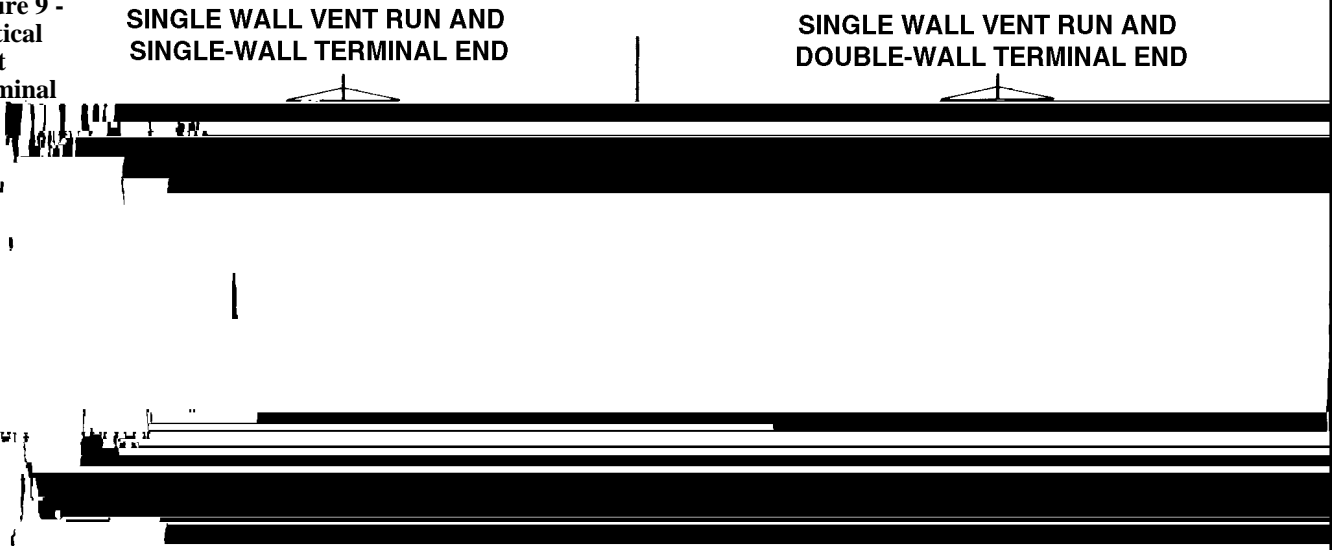
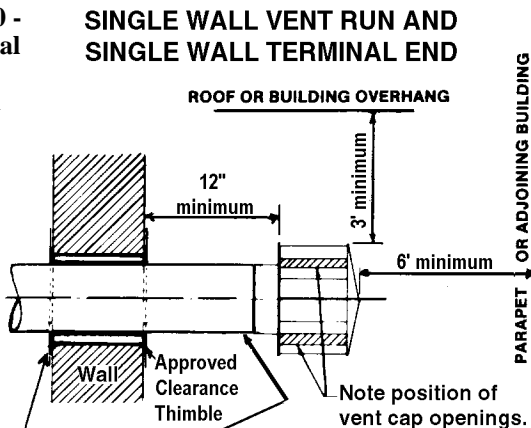
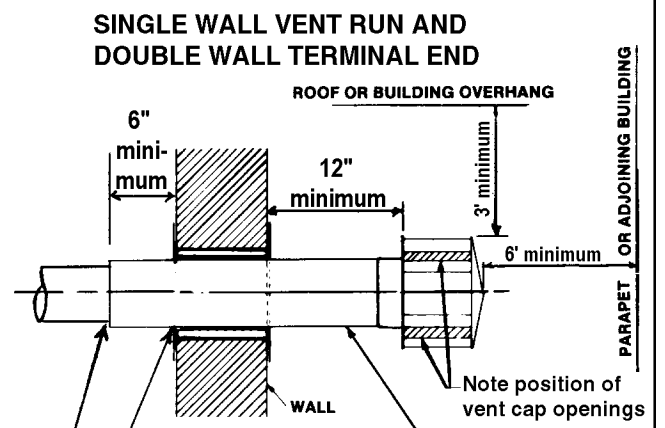

Figure 10 - Horizontal Vent Terminal



Approved clearance thimble for single-wall vent pipe is required when flue pipe extends through combustible materials.

Pitch flue pipe down toward outlet 1/4" per foot for condensate drainage. (NOTE: Applies to entire horizontal vent run.)



Clearance thimble required when flue pipe extends through combustible materials. Follow requirements of double-wall pipe manufacturer.

Pitch flue pipe down toward outlet 1/4" per foot for condensate drainage. (Note: Applies to entire horizontal vent run.)

Follow the instructions to join single and double wall pipe and to seal the connection.

Horizontal Vent Terminal Clearances

The location of the termination of the horizontal vent system must be in accordance with National Fuel Gas Code Z223.1. See table for required minimum clearances.

If the vent terminal is to be installed near ground level, position it at least six inches above maximum anticipated snow depth.

NOTE: Maintain the required clearance from the wall to the vent terminal cap for stability under wind conditions and to protect the building.

Structure	Minimum Clearances for Vent Termination Location (all directions unless specified)
Forced air inlet within 10 ft (3.1m)	3 ft (0.9m) above
Combustion air inlet of another appliance	6 ft (1.8m)
Door, window or gravity air inlet (any building opening)	4 ft (1.2m) horizontally
	4 ft (1.2m) below
	3 ft (0.9m) above
Electric meter, gas meter * and relief equipment	4 ft (1.2m) horizontally
Gas regulator *	3 ft (0.9m)
Adjoining building or parapet	6 ft (1.8m)
Grade (ground level)	7 ft (2.1m) above

*Do not terminate the vent directly above a gas meter or service regulator.

11. Duct Connections

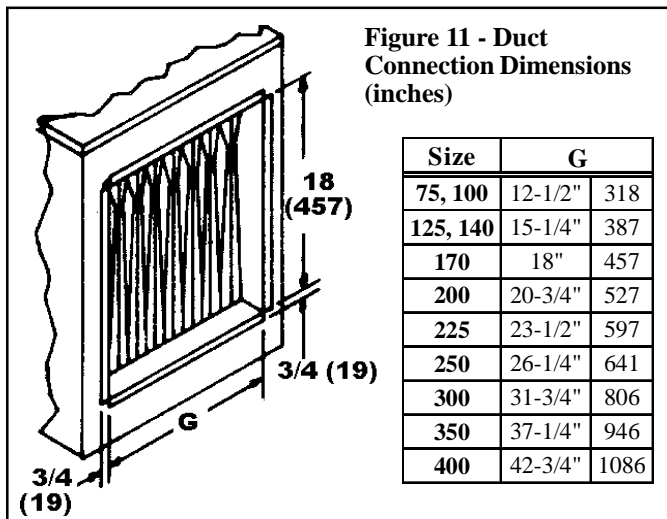

NOTE: If the furnace is equipped with a unit-mounted ductstat (Option AG3), the sensing bulb must be removed from the mounting bracket (save the retainer clip) before the ductwork can be attached. See instructions in Paragraph 22 for re-mounting the sensor.

Requirements and Suggestions for Connecting and Installing Ducts

- **Type of Ductwork** - The type of duct installation to be used depends in part on the type of construction of the roof (whether wood joist, steelbar joist, steel truss, pre-cast concrete) and the ceiling (whether hung, flush, etc.).
- **Ductwork Material** - Rectangular duct should be constructed of not lighter than No. 26 U.S. gauge galvanized iron or No. 24 B & S gauge aluminum.
- **Ductwork Structure** - All duct sections 24 inches or wider, and over 48 inches in length, should be cross broken on top and bottom and should have standing seams or angle-iron braces. Joints should be S and drive strip, or locked.
- **Through Masonry Walls** - No warm air duct should come in contact with masonry walls. Insulate around all air duct through masonry walls with not less than 1/2" (1" is recommended) of insulation.
- **Through Unheated Space** - Insulate all exposed warm air ducts passing through an unheated space with at least 1/2" (1" is recommended) of insulation.
- **Duct Supports** - Suspend all ducts securely from adjacent buildings members. Do not support ducts from unit duct connections.
- **Duct Sizing** - Proper sizing of the supply air ductwork is necessary to ensure a satisfactory heating installation. The recognized authority for such information is the Air Conditioning Contractors Association, 1228 17th Street N.W., Washington, D.C. 20036. A manual covering duct sizing in detail may be purchased directly from them.
- **Removable Panels** - The ducts should have removable access panels on both upstream and downstream sides of the furnace. These openings must be accessible when the furnace is in service and should be a minimum of 6" x 10" in size so smoke or reflected light may be observed inside the casing to indicate the presence of leaks in the heat exchanger. The covers for the openings must be attached in such a manner as to prevent leakage. See Figure 12A.
- **Supply Air Duct/Furnace Horizontal Connection** - The seal between the furnace and the duct must be mechanical. Duct connection should be made with "U" type flanges on the top and bottom of the connecting duct. Slide the duct over the flanges of the heater giving an airtight fit. Provide "U" type channels for the other side flanges to ensure tight joints. Use sheetmetal screws to fasten ducts and "U" channels to the furnace flange. See Figures 12B and 12C.

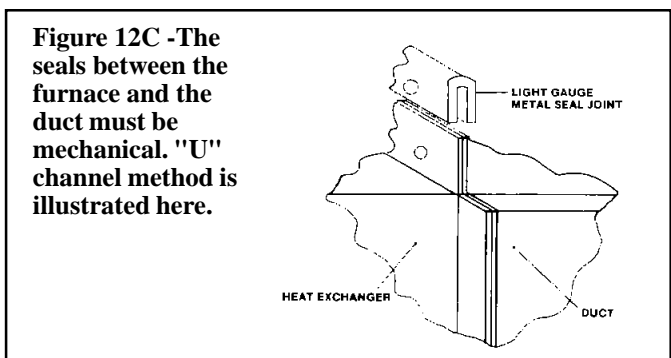
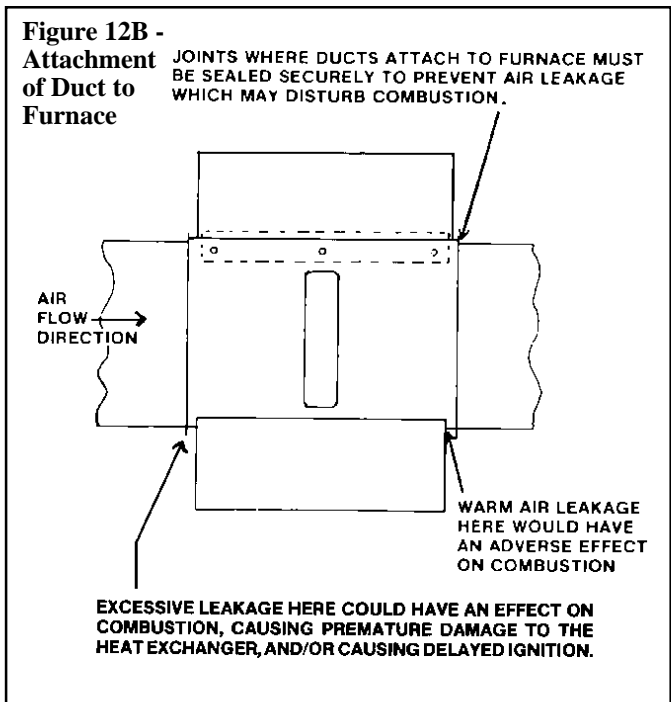
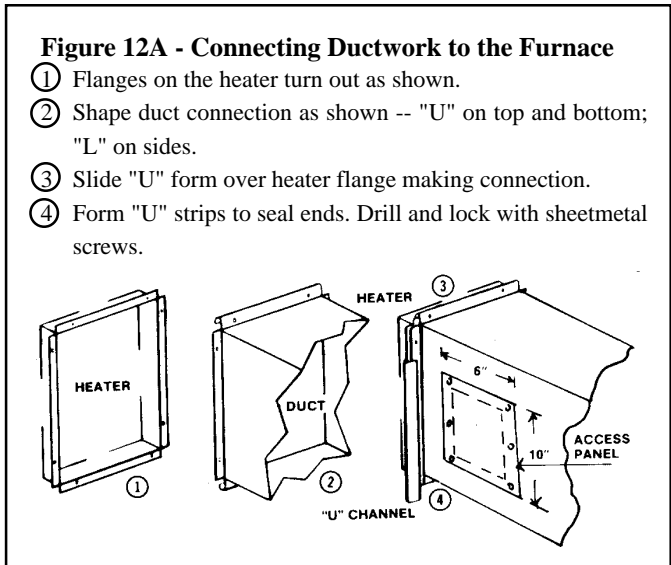

CAUTION: Joints where ducts attach to furnace must be sealed securely to prevent air leakage into burner rack area. Leakage can cause poor combustion, pilot problems, shorten heat exchanger life and cause poor performance. See Hazard levels, page 2.

12. Condensate Drain, Option CS1, for Furnaces Used with Refrigeration Systems

These furnaces are certified for installation upstream or downstream from refrigerated units supplying air below the dew point of the ambient air surrounding the furnace. When installed downstream from a refrigeration system, condensation will form and therefore, adequate provision must be made to dispose of the condensate. A drain flange, Option CS1, may be installed on the furnace casing as shown in Figure 13. When using Option CS1, seal all holes in the bottom pan. Terminate the drain outside of the building. NOTE: A 4-inch minimum clearance is required under the furnace if a 90° street elbow is used.

Periodic cleaning of the condensate collection and the disposal system is required.

Figure 13 - Condensate Drain, Option CS1 (P/N 31765)

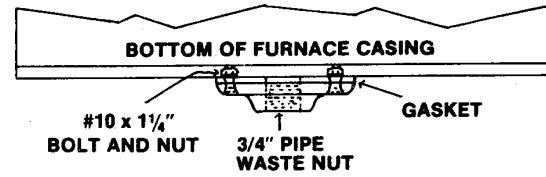

Seal holes in bottom pan. Terminate drain outside of building. Periodic cleaning of the condensate collector and disposal system is required.

13. Duct Furnace Air Flow Requirements

The duct furnace must be installed on the positive pressure side of the field supplied blower. The air throughput must be within the CFM range stated on the heater rating plate. The air distribution must be even over the entire heat exchanger. Turning vanes should be employed in elbows or turns in the air inlet to ensure proper air distribution (See Paragraph 15). If it is determined that the blower CFM is greater than allowed or desirable, see Paragraph 14 for instructions on determining the correct size of bypass duct required. To determine temperature rise, the inlet and outlet air temperatures should be measured at points not affected by heat radiating from the heat exchanger. The following charts show the approved temperature rise range with the required CFM and the internal pressure drop for each size of unit.

Model EEDU (80% thermal efficient)

Size	75		100		125		140		170		200		225		250		300		350		400	
Temperature Rise	CFM	P.D.	CFM	P.D.	CFM	P.D.	CFM	P.D.	CFM	P.D.	CFM	P.D.	CFM	P.D.	CFM	P.D.	CFM	P.D.	CFM	P.D.	CFM	P.D.
50°F	1105	0.24	1475	0.43	1840	0.49	2065	0.65	2505	0.67	2945	0.67	3315	0.69	3685	0.67	4420	0.70	5160	0.75	5895	0.77
60°F	920	0.16	1225	0.30	1535	0.33	1720	0.43	2085	0.46	2455	0.46	2765	0.47	3070	0.45	3685	0.47	4300	0.52	4915	0.52
70°F	790	0.10	1050	0.21	1315	0.25	1475	0.32	1790	0.33	2105	0.35	2370	0.36	2630	0.34	3160	0.35	3685	0.38	4210	0.38
80°F	695	0.07	920	0.16	1150	0.20	1290	0.24	1565	0.25	1840	0.26	2070	0.27	2300	0.26	2765	0.27	3225	0.28	3685	0.28
90°F	615	0.05	815	0.12	1020	0.17	1145	0.20	1390	0.19	1635	0.20	1840	0.21	2045	0.20	2455	0.22	2565	0.23	3275	0.22

Model HEEDU (80% thermal efficient, high CFM)

Size	75		100		125		140		170		200		225		250		300		350		400	
Temperature Rise	CFM	P.D.	CFM	P.D.	CFM	P.D.	CFM	P.D.	CFM	P.D.	CFM	P.D.	CFM	P.D.	CFM	P.D.	CFM	P.D.	CFM	P.D.	CFM	P.D.
20°F	2765	0.60	3685	1.09	4605	1.14	5160	1.50	6265	1.64	7370	1.64	8295	1.69	9215	1.67	11060	1.64	12900	1.64	14745	1.64
30°F	1840	0.28	2455	0.50	3070	0.52	3440	0.66	4175	0.73	4915	0.73	5530	0.75	6140	0.72	7370	0.73	8600	0.73	9830	0.73
40°F	1380	0.16	1840	0.28	2300	0.27	2580	0.36	3130	0.38	3685	0.39	4145	0.40	4605	0.40	5530	0.39	6450	0.40	7370	0.38
50°F	1105	0.12	1475	0.18	1840	0.18	2065	0.22	2505	0.24	2945	0.24	3315	0.26	3685	0.24	4420	0.24	5160	0.25	5895	0.24
60°F	920	0.10	1225	0.13	1535	0.14	1720	0.17	2085	0.17	2455	0.17	2765	0.18	3070	0.17	3685	0.17	4300	0.18	4915	0.17
65°F	850	0.08	1130	0.11	1415	0.12	1585	0.15	1925	0.14	2265	0.14	2552	0.15	2835	0.14	3400	0.14	3970	0.15	4535	0.15
70°F	--	--	--	--	--	--	--	--	1790	0.12	2105	0.12	2370	0.13	2630	0.11	3160	0.12	3685	0.13	4210	0.13

14. Constructing Bypass Duct

When the CFM of air throughput is greater than desirable or permissible for the unit, a bypass duct may be constructed. Follow these instructions to determine the correct size of the bypass duct.

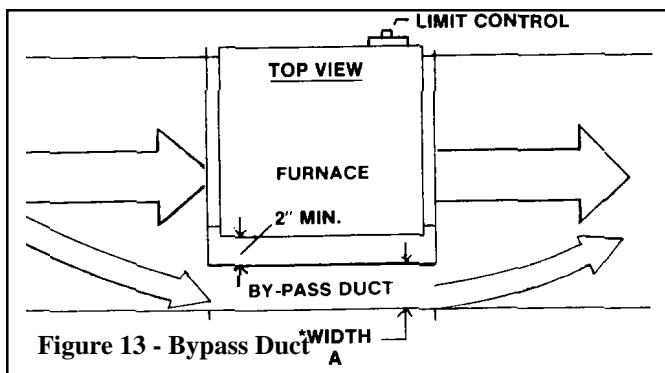

Figure 13 - Bypass Duct

Directions for Sizing Bypass Duct

- From the tables in Paragraph 13, find the pressure drop (P.D.) and the allowable CFM for the furnace that is being installed.

Example: Standard Size 170 @ 70°F temperature rise;
P.D. .33; CFM 1790

"A" Width	Bypass CFM									
	Pressure Drop through the Furnace									
	0.10	0.15	0.20	0.25	0.30	0.35	0.40	0.45	0.50	
3"	490	530	610	700	780	830	900	960	1010	
4"	630	750	870	980	1090	1160	1250	1310	1400	
5"	850	1010	1190	1300	1410	1520	1640	1730	1810	
6"	1050	1290	1480	1650	1800	1940	2090	2200	2320	
7"	1250	1510	1760	1960	2180	2320	2500	2650	2800	
8"	1490	1810	2100	2350	2560	2760	2940	3110	3290	
9"	1700	2100	2400	2700	2970	3200	3400	3600	3800	
10"	1920	2350	2760	3090	3650	4020	4300	4550	4800	

- Subtract the allowable CFM from the actual CFM of the installation to determine how much air must be diverted through the bypass duct.

Example: Blower CFM 3000
Allowable CFM -1790
Bypass CFM 1210

- Go to the column in the Bypass CFM Chart that is closest to the pressure drop through the heater. Move down in that column until you find the CFM closest to the answer in Step 2).

Example: P.D. .35
Bypass CFM 1520

14. Bypass Duct (cont'd)

4) Move to the left column to find out the required size of the bypass duct.

Example: Bypass Duct
Size is 5"

Depth of the bypass duct is 18" on both inlet and outlet ends. Bypass duct must be located on side opposite controls and 2" from the heat exchanger side panel.

NOTE: Not all capacities are covered in this chart. If your installation is not covered, the correct size may be determined by consulting the factory representative.

15. Furnace Blower Connections

Requirements: Proper arrangements of blower and duct furnace with respect to angle of approach of the duct connection and the arrangement of the discharge opening of the blower are shown. Blowers should be bottom horizontal discharge when coupled to the duct furnace. When a top horizontal discharge blower is connected to the duct furnace, be sure that sufficient length of duct is provided to permit even flow of air at the end of the duct. Or, baffles may be inserted between the blower and the heater to assure an even flow of air across the heat exchanger. See illustrations in Figure 14.

WARNING: The furnace must be installed on the positive pressure side of the air-circulating blower. See Hazard Levels, page 2.

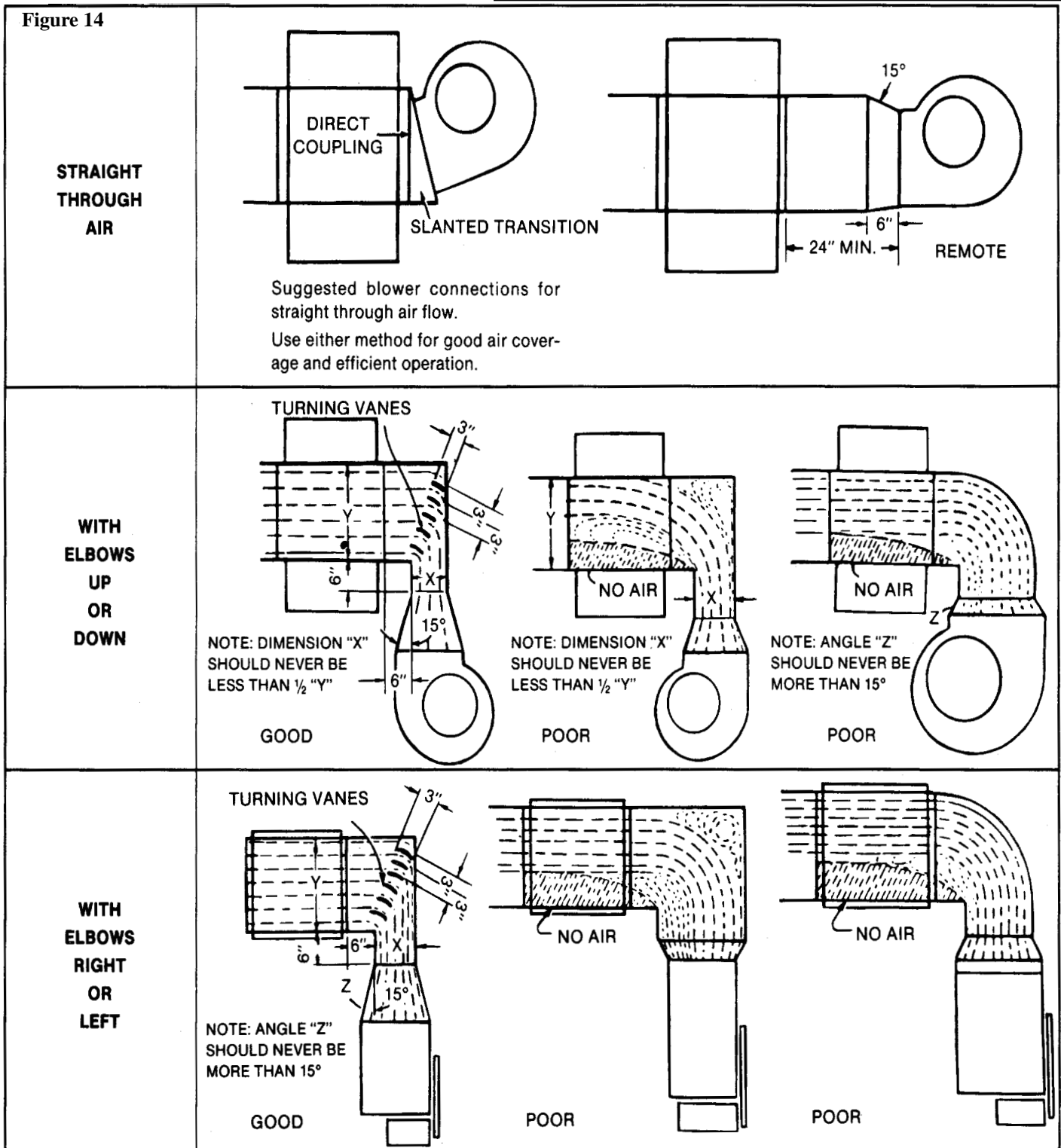

16. Combustion Air Proving Switch

The combustion air proving switch is a pressure sensitive switch that monitors air pressure to ensure that proper combustion air flow is available. The switch is a single pole - normally open - device which closes when a decreasing pressure is sensed in the outlet duct of the flue gas collection box.

On start-up when the heater is cold, the sensing pressure is at the most negative level, and as the heater and flue system warm up, the sensing pressure becomes less negative. After the system has reached equilibrium (about 20 minutes), the sensing pressure levels off.

If a restriction or excessive flue length or turns cause the sensing pressure to become less than the switch setpoint, the pressure switch will function to shut off the main burners. The main burners will remain off until the system has cooled and/or the flue system resistance is reduced. The Table on the below lists the approximate water column negative pressure readings and switch setpoints for sea level operating conditions.

Start-Up Cold	Equilibrium	Set Point "Off"	Set Point "On"
-1.0" w.c.	-0.60" w.c.	-0.48" w.c.	-0.65" w.c.

DANGER: Safe operation of this unit requires proper venting flow. NEVER bypass combustion air proving switch or attempt to operate the unit without the venter running and the proper flow in the vent system. Hazardous conditions could result. See Hazard Levels, page 2.

17. Electrical Supply and Connections

All electrical wiring and connections, including electrical grounding MUST be made in accordance with the National Electric Code ANSI/NFPA No. 70 (latest edition) or, in Canada, the Canadian Electrical Code, Part I-C.S.A. Standard C22.1. In addition, the installer should be aware of any local ordinances or gas company requirements that might apply.

Check the rating plate on the heater for the supply voltage and current requirements. A separate line voltage supply with fused disconnect switch should be run directly from the main electrical panel to the furnace, making connection to leads in the junction box. All external wiring must be within approved conduit and have a minimum temperature rise of 63°F. Conduit from the disconnect switch must be run so as not to interfere with the service panels of the furnace.

If the heater has field-installed options that require electrical connections, consult the instruction sheet and wiring diagram supplied in the option package.

CAUTION: If any of the original wire as supplied with the appliance must be replaced, it must be replaced with wiring material having a temperature rating of at least 105°C, except for sensor lead wires which must be 150°C. See Hazard Levels, page 2.

Specific wiring diagrams that include standard and factory-installed options are included with the heater. **Typical wiring diagrams are on page 17.**

Figure - 15 - Field Wiring Connections

Connect Field Wiring in the Electrical Box

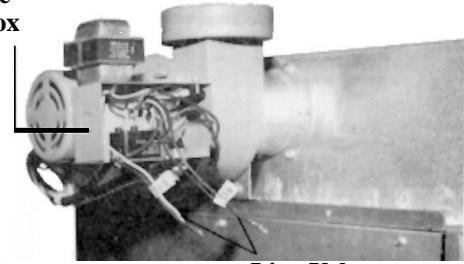

Line Voltage Connection Tabs

Operating Sequence

1. Set thermostat at lowest setting
2. Turn on the power to the unit.
3. Turn on main and pilot manual gas valve.
4. Set thermostat at desired setting.
5. Thermostat calls for heat energizing the venter motor.
6. Pressure switch closes, energizing the pilot gas valve and spark gap to produce a pilot flame on each operating cycle. The sensing probe proves the presence of pilot flame and energizes the safety switch portion of the control. The switch action de-energizes the spark gap and energizes the main gas valve.
7. Fan control (Optional) senses heat exchanger temperature energizing the fan or blower motor of the air handler.
8. If the pilot flame is extinguished during main burner operation, the sensing probe detects the absence of the flame and causes the safety switch to close the main valve. On units with standard intermittent spark pilot systems, the spark gap recycles. On units with optional spark ignition with lockout, if the pilot is not established within the timing cycle (approximately 120 seconds), the unit locks out and must be reset by interrupting power to the control circuit.

Disconnect Switch

A disconnect switch is a required part of this installation. Switches are available, as options or parts, or may be purchased locally. When ordered as an optional component, the disconnect switch is shipped separately.

The disconnect switch may be fusible or non-fusible. When installing, be careful that the conduit and switch housing are clear of furnace panels and inspection plates. Allow at least four feet of service room between the switch and removable panels.

Control Thermostat

A thermostat is not standard equipment but is an installation requirement. Use either an optional thermostat available with the heater or a field-supplied thermostat. Install according to the thermostat manufacturer's instructions.

A 24 volt thermostat must be used to actuate low voltage gas controls. If line voltage from the thermostat to the unit is desired, consult the factory representative.

Wiring between the thermostat and the heater must be suitable for a temperature rise of 63°F. Labeled thermostat leads are provided in the heater junction box for connection of thermostat wiring.

Thermostats should be located five feet above the floor on an inside wall, not in the path of warm or cold air currents, not in corners where air may be pocketed. Do NOT install on cold air walls. For specific connection details, refer to instruction packet with the thermostat.

If more than one unit is cycled from one thermostat, separately activated relays must be substituted at unit thermostat connections.

Typical Wiring Diagrams -- Refer to the diagram supplied with the heater for specific controls or optional equipment.

Single-Stage with Intermittent Spark Pilot System with or without Lockout

W.D. 110920

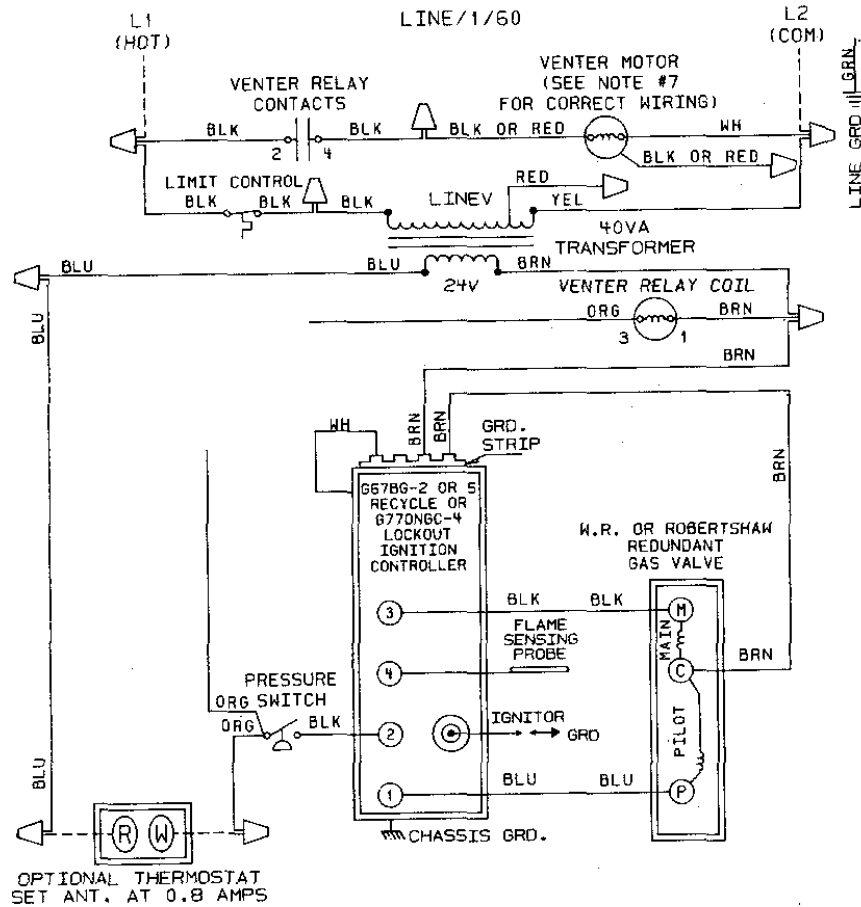

Field and Replacement Wiring Notes

1. Dotted wiring supplied by others.
2. Thermostat supplied as optional equipment.
3. Use #14 gauge wire for line wiring to unit.
4. Use #18 gauge wire for control wiring.
5. Line and blower motor branch circuit wire sizes should be of a size to prevent voltage drops beyond 5% of supply line voltage.
6. On 208-230V units, the control transformer has dual voltage primary.
 For 208 volt units, use black and red leads (cap yellow).
 For 230 volt units, use black and yellow leads (cap red).
 On 115 volt units, the control transformer is single voltage primary. Use black and yellow leads for 115 volt.
 Secondary side of transformer (24V), use blue and brown leads.
7. **Sizes 75-250, 208 volts**, the venter motor wires are black and white (cap red).
Sizes 75-250, 230 volts, the venter motor wires are red and white (cap black).
Sizes 75-250, 115 volts, the venter motor wires are black and white.
Sizes 300-400, all voltages, the venter motor wires are black and white.

ALTERNATE HONEYWELL REDUNDANT GAS VALVE

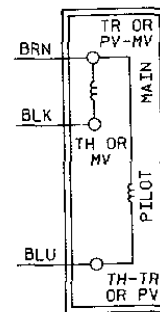

Field Control Wiring - Length and Gauge		
Total Wire Length	Distance from Unit to Control	Minimum Recommended Wire Gauge
150'	75'	#18 gauge
250'	125'	#16 gauge
350'	175'	#14 gauge

CAUTION: If any of the original wire as supplied with the appliance must be replaced, it must be replaced with wiring material having a temperature rating of at least 105°C, except for sensor lead wires which must be 150°C. See Hazard Levels, page 2.

Two-Stage with Intermittent Spark Pilot System with or without Lockout

W.D. 110824

6
7
8
9
10
11
12
13
14
15
16
17
18
19
20
21
22

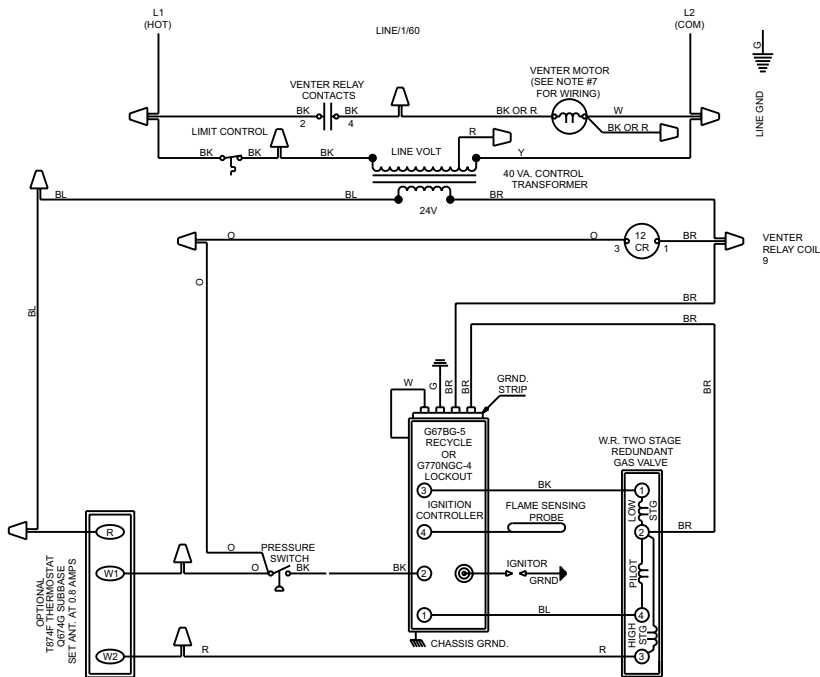

- OPERATING SEQUENCE**
1. SET THERMOSTAT SWITCH AT "OFF" POSITION.
 2. TURN ON MAIN AND PILOT MANUAL GAS VALVES.
 3. TURN ON POWER TO UNIT.
 4. SET THERMOSTAT SWITCH AT "ON" POSITION.
 5. LOW STAGE OF THERMOSTAT CALLS FOR HEAT ENERGIZING THE VENTER MOTOR.
 6. PRESSURE SWITCH CLOSED ENERGIZING THE PILOT GAS VALVE AND SPARK GAP TO PRODUCE A PILOT FLAME ON EACH OPERATING CYCLE. THE SENSING PROBE PROVES THE PRESENCE OF THE PILOT FLAME AND ENERGIZES THE SAFETY SWITCH PORTION OF THE CONTROL. THE SWITCH ACTION DE-ENERGIZES THE SPARK GAP AND ENERGIZES THE LOW STAGE GAS VALVE.
 7. HIGH STAGE OF THERMOSTAT CALLS FOR HEAT ENERGIZING THE HIGH STAGE GAS VALVE, FIRING UNIT AT FULL RATE.
 8. IF THE FLAME IS EXTINGUISHED DURING MAIN BURNER OPERATION THE SAFETY SWITCH CLOSING THE MAIN VALVE AND RECYCLES THE SPARK GAP.
 - ON UNIT EQUIPPED WITH G770NGC-4 LOCKOUT CONTROL, IF PILOT IS NOT ESTABLISHED WITHIN 120 SECONDS (APPROX.) UNIT LOCKS OUT AND MUST BE RESET BY INTERRUPTING POWER TO CONTROL CIRCUIT. (SEE LIGHTING INSTRUCTIONS)

- NOTES**
1. DOTTED WIRING SUPPLIED AND INSTALLED BY OTHERS.
 2. CAUTION: IF ANY OF THE ORIGINAL WIRE AS SUPPLIED WITH THE APPLIANCE MUST BE REPLACED, IT MUST BE REPLACED WITH WIRING MATERIAL HAVING A TEMPERATURE RATING OF AT LEAST 105 DEGREES C., EXCEPT FOR ENERGY CUT-OFF OR SENSOR LEAD WIRE WHICH MUST BE 150 DEGREES C.
 3. LIMIT WIRE TO BE #18 GA. 200 C. SF-1 OF SEW-1.
 4. USE #14 GA. WIRE FOR LINE WIRING TO UNIT.
 5. LINE AND BLOWER MOTOR BRANCH CIRCUIT WIRE SIZES SHOULD BE OF A SIZE TO PREVENT VOLTAGE DROP BEYOND FIVE PERCENT OF SUPPLY LINE VOLTAGE.
 6. ON 208/230V. UNITS THE CONTROL TRANSFORMER HAS A DUAL VOLTAGE PRIMARY. FOR 208V. UNITS USE BLACK AND RED LEADS (CAP YELLOW). FOR 230V. UNITS USE BLACK AND YELLOW LEADS (CAP RED).
 - ON 115V. UNITS THE CONTROL TRANSFORMER IS SINGLE VOLTAGE PRIMARY. USE BLACK AND YELLOW LEADS FOR 115V. SECONDARY SIDE OF TRANSFORMER (24V.) USE BLUE AND BROWN LEADS.
 - ON 75-250 208V UNITS, THE VENTER MOTOR WIRES ARE BLACK AND WHITE (CAP RED) ON 75-250 230V UNITS, THE VENTER MOTOR WIRES ARE RED AND WHITE (CAP BLACK) ON 75-250 115V UNITS AND 300-400 UNITS ALL VOLTAGES, THE VENTER MOTOR WIRES ARE BLACK AND WHITE.

FIELD CONTROL WIRING

TOTAL WIRE LENGTH	MINIMUM WIRE SIZE	RECOMMENDED WIRE SIZE
150 FEET	#18 GA.	#18 GA.
250 FEET	#18 GA.	#16 GA.
350 FEET	#14 GA.	#14 GA.

18. Limit Switch

A non-adjustable high limit switch mounted at the outlet air side of the heat exchanger acts to shut off the gas supply in the event of air handler motor failure, lack of correct air flow (See Paragraph 13), or restriction due to filters and/or duct design. See Figure 16 for mounting and service.

Depending on accessibility, the limit switch may be serviced from either the outside of the unit or from the inside through the access panel in the discharge duct. When units are installed side by side, the service access panel must be in either the top or bottom of the ductwork for limit switch service. (See Paragraphs 8 and 11.)

WARNING: If you turn off the power supply, turn off the gas. See Hazard Levels, page 2.

Figure 16 - Access to the limit switch depends on the installation



View of limit switch from "inside" the furnace

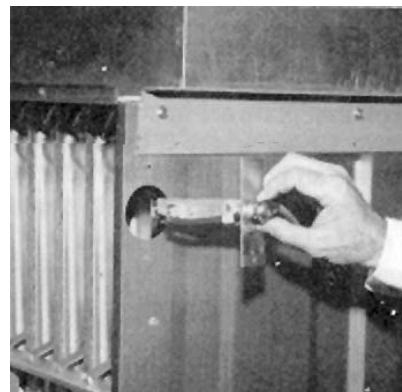

Access to limit switch from "outside" the furnace

19. Fan Control (Optional, Field Installed)

NOTE: Required with makeup air gas control options; see Paragraphs 22 and 23.

1. Fan control provides the following: a) Delay of fan operation preventing circulation of cold air, and b) Fan operation as long as the unit is hot.
2. The fan control provides additional safety by keeping the fan in operation in the event that the gas valve fails to close when the thermostat is satisfied.
3. To be sure that the fan can continue to operate, the power supply to the heater MUST NOT be interrupted except when servicing the heater.
4. If the customer wants the heater off at night, the gas valve circuit SHOULD BE OPENED by a single pole switch wired in series with the thermostat. Some thermostats are provided with this feature. Multiple units controlled from a single thermostat are shut off in the same manner. For proper operation, be sure fan control wiring is observed. See Figure 17 for installation of fan control and wiring.

WARNING: If you turn off the power supply, turn off the gas. See Hazard Levels, page 2.

Figure 17 - Installation of Optional Fan Control Kit, Option CQ1 (P/N 57960)

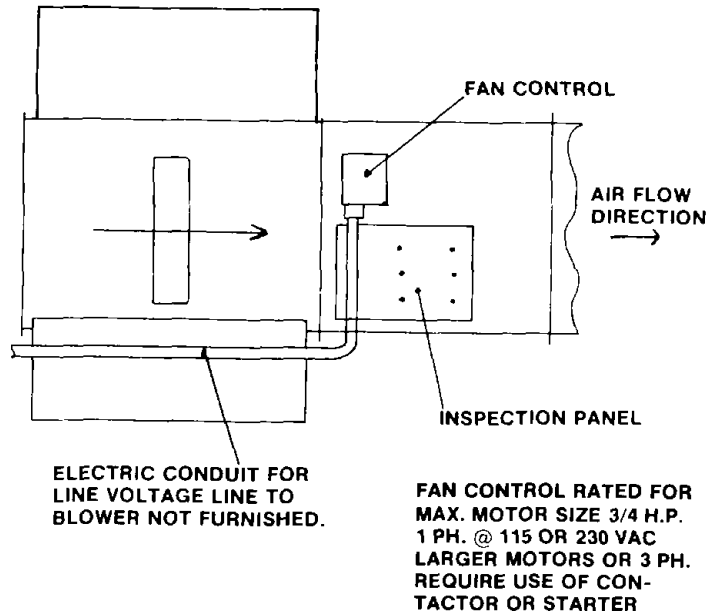

Location of the Fan Control Mounting Holes

Install the gasket supplied in the option kit between the fan control and the duct.

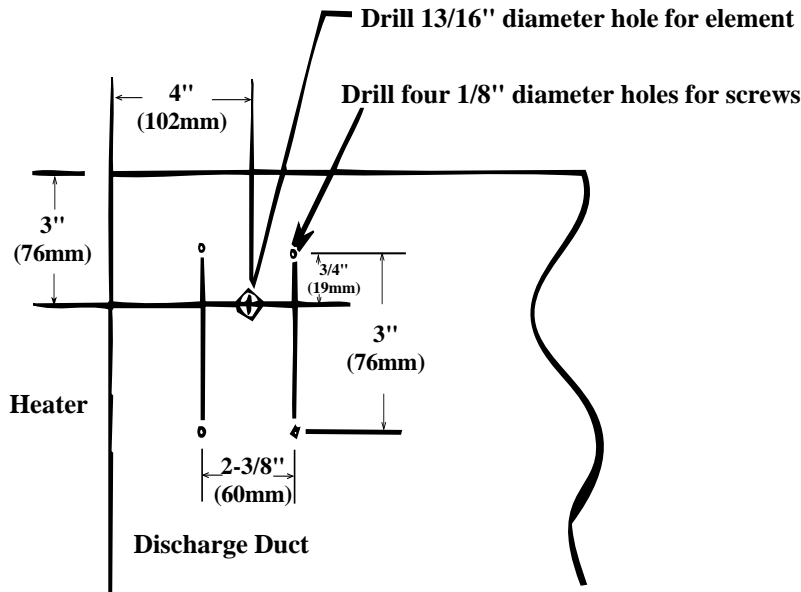

Recommended dial setting for most conditions 130°F ON and 100°F OFF

Typical Fan Control Wiring (W.D. 145977)

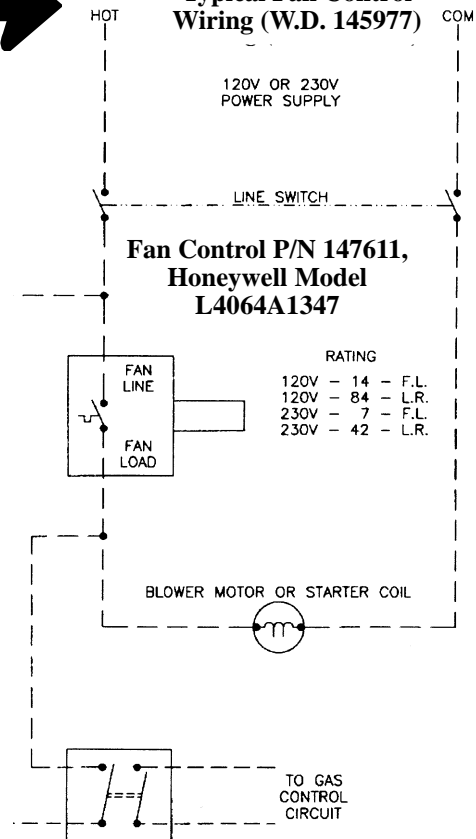

DP-ST Control Switch (Used with Options AG3, AG8, AG9, AG15, and AG16)

20. Gas Valve

All furnaces are equipped with a 24-volt combination valve which includes the automatic electric on-off valve controlled by the room thermostat, the pressure regulator, the safety pilot valve, and the manual shutoff valve. The standard gas valve allows for single-stage control from a single-stage, 24-volt thermostat.

WARNING: The operating valve is the prime safety shutoff. All gas supply lines must be free of dirt or scale before connecting the unit to ensure positive closure. See Hazard Levels, page 2.

21. Optional Two-Stage Operation - Heating Only Application

NOTE: This option is not available on Size 75 using propane gas.

The standard combination control valve is replaced with a two-stage combination gas control valve providing for low fire or high fire operation controlled by a two-stage thermostat. First stage (low fire) is factory set (not field adjustable). Both high and low stages are controlled by a Servo regulator, maintaining constant gas input under wide variations in gas supply pressure. See instructions packed with the unit for specific gas valve specifications, wiring, and operating instructions.

22. Optional Two-Stage Operation - Makeup Air Application

NOTES: Requires field installed fan control, see Paragraph 19. This option is not available on Size 75 using propane gas.

Two-stage makeup air units are equipped with a two-stage gas valve, but instead of control from a two-stage room thermostat, the outlet air temperature is monitored and controlled by a two-stage ductstat. When the discharge air temperature drops to the setpoint, low fire is energized. If low fire cannot satisfy the ductstat setting, high fire is energized.

Makeup air applications are usually adjusted to discharge an outlet air temperature between 65°F and 75°F. In all applications, the allowable temperature rise of the furnace in the installation dictates the limits of the ductstat temperature setting.

Depending on the option selection, the factory-installed sensor is either field-connected by capillary tubing to the unit-mounted ductstat (Option AG3), Figures 18 and 19, or electrically connected to a remote electronic remote temperature selector (Options AG15 or AG16, Figure 20). The remote temperature selector is available with or without a display module.

Optional Ductstat with Capillary Tubing (Option AG3) -- The ductstat is attached to the side of furnace and is connected by capillary tubing to the sensor which is mounted on a bracket on the inner part of the furnace duct side (See Figure 18). In order to attach the discharge ductwork to the furnace, the sensor must be removed from the bracket and the capillary tubing moved out of the way. Follow the illustrated instructions in Figure 18 for re-connecting the ductstat after the ductwork is attached.

The ductstat dial is illustrated in Figure 19. The dial has an adjustable range from 60°F to 100°F with a fixed differential of 2-1/2°F. Due to different CFM settings and outside air temperatures, the average downstream outlet air temperature may not match the ductstat exactly. After the installation is complete, adjust the ductstat setpoint to achieve the desired average outlet air temperature.

Figure 18 - Ductstat/Sensing Bulb Locations for Furnace with Option AG3

The ductstat provided with Option AG3 is attached to the side of the furnace at the factory.

The sensor is mounted on a bracket on the inner part of the furnace duct side.

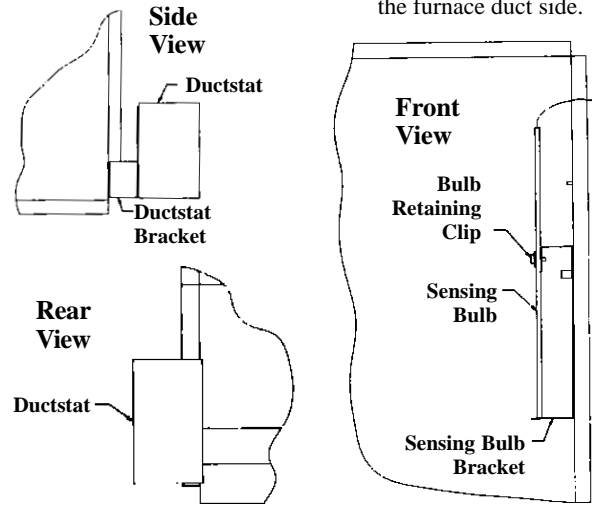

The Sensor and the ductstat are connected by a permanently attached capillary tubing. In order to attach the discharge ductwork, the sensor must be removed from the bracket (save the retaining clip) and the capillary tubing moved out of the way. After the ductwork is attached to the furnace (See Paragraph 12), a hole must be made in the ductwork to allow for the sensor to be re-installed on the bracket (capillary tubing with sensor will run through the hole). A removable access panel must be provided in the ductwork as shown in Figure 12A, Paragraph 12.

Parts Required and Instructions:

Since the sensor is larger than the tubing, a gasket and gasket retainer plate are needed to plug the hole and protect the capillary tubing where it passes through

Qty	P/N	Description
1	7726	Gasket
1	7727	Gasket Retainer Plate

the ductwork. These parts were shipped loose with the furnace. Two field-supplied sheet metal screws will be needed to attach the plate.

1) **Drill the Holes** - Refer to the illustration below and select a location on the ductwork so that a minimum length of capillary tubing will be inside the ductwork. Following the pattern, drill holes in the ductwork.

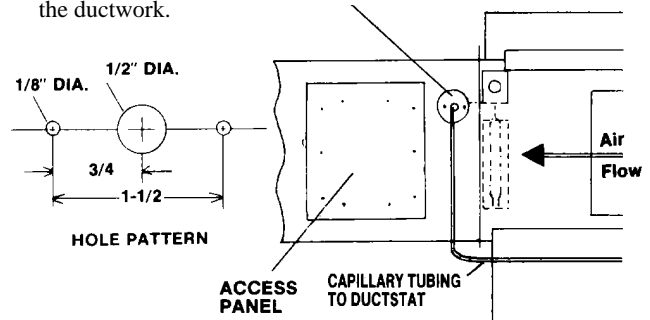

2) **Re-Mount the Sensor on the Bracket** - Push the sensor through the hole. Remove the ductwork access plate. Reaching through the access hole, use the retaining clip to re-mount the sensor on the bracket.

3) **Install the Gasket** - Slide the gasket and hole retainer plate over the capillary tubing. With the gasket next to the ductwork, attach the hole retaining plate with field-supplied sheet metal screws (as illustrated above). Close the ductwork access panel.

22. Optional 2-Stage Operation (cont'd)

Dial has no temperature markings. Pin on adjustment screw pointing to "B" equals approximately 70°F.

Figure 19 - Ductstat Control in Option AG3 (Mounted in inverted position)

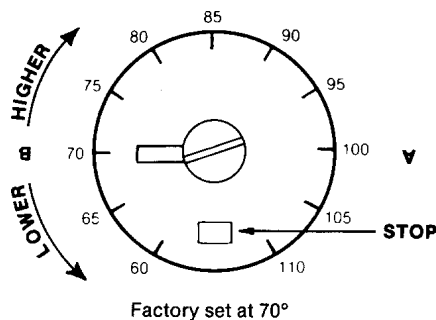

Optional Ductstat with Electronic Remote Setpoint Module (Options AG15 and AG16) -- The field-installed sensing probe is field-wired to a remote temperature selector with a temperature operating range to 130°F. The remote modules and a required transformer are shipped separately for field installation. (Do not wire the remote module to the control transformer on the furnace.) Follow the wiring diagram with the unit and the manufacturer's instructions for wiring and installation. There will be one module for selecting temperature and one-stage adder module. Option AG16 includes the digital display module. See Figure 20.

CAUTION: The remote temperature selector heat/cool selector switch is factory-set in cool position. To function properly, set switch to heat position.

Figure 20 - Remote Temperature Selector, Stage-Adder Module, and Optional Display Module for Ductstat in Two-Stage Makeup Air Control Options (Option AG15 or AG16)



23. Optional Electronic Modulation

Note: Requires field-installed fan control.

The type and capability of the electronic modulation system, depends on the option selected. Electronic modulation options are identified by a suffix to the Serial No. printed on the heater rating plate. AG7 is identified as MV-1; AG8 is identified as MV-3; AG9 is identified as MV-4; and AG21 is identified as MV-A.

Electronic Modulation between 50% and 100% Firing Rate (Options AG7, AG8, AG9) - Depending on the heat requirements as established by the thermistor sensor, the burner modulates between 100% and 50% firing. The thermistor is a resistor that is temperature sensitive in that as the surrounding temperature changes, the Ohms resistance changes through the thermistor. This change is monitored by the solid state control center (amplifier) which furnishes varying DC current to the modulating valve to adjust the gas input.

Each modulating valve is basically a regulator with electrical means of raising and lowering the discharge pressure. When no DC current is fed to this device, it functions as a gas pressure regulator, supplying 3.5" w.c. pressure to the main operating valve.

Refer to the wiring diagram supplied with the furnace for proper wiring connections. Electronic modulation for heating controlled by a specially designed room thermostat (60°-85°F) is identified as Option AG7 and is available on unit heater, duct furnace and packaged heater mod-
Form 421, Page 20

els. Electronic modulation control systems for makeup air applications controlled by a duct sensor and temperature selector (55-90°F) are identified as either Option AG8 or Option AG9. The temperature selector setting for Option AG8 is on the amplifier; Option AG9 has a remote temperature selector. Both systems are available with an override thermostat. Options AG8 and AG9 for makeup air applications apply to duct furnace and packaged systems.

Computer Controlled Electronic Modulation between 50% and 100% Firing Rate (Option AG21) - With this option the furnace is equipped with a Maxitrol A200 signal conditioner which operates much the same way as the amplifier above to control the regulator valve.

The conditioner accepts an input signal of either 4-20 milliamps or 0-10 volts from a customer-supplied control device such as a computer. With the dip switches on the conditioner in the "on" positions, the conditioner accepts a 4-20 milliamp signal. In the "off" positions, the conditioner accepts a 0-10V signal. The conditioner converts the signal to the 0 to 20 volt DC current required to control the modulating valve.

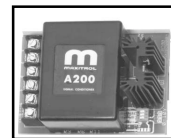

24. Pilot and Ignition Systems

A gas-fired intermittent pilot is standard. The vertical pilot is located under the aeration panel on the control end of the burner tray and is accessible only after the burner rack has been removed. Remove the pilot for maintenance or service, such as checking the wiring and cleaning. (See Paragraph 30.) All pilots are target type with lint-free feature. Pilot gas pressure should be the same as supply line pressure. (See Paragraph 9.) If required, adjust the pilot flame length to approximately 1-1/4" with the pilot adjustment screw in the control valve body.

NOTE: This model furnace manufactured prior to 11/95 had a horizontal pilot with a spark gap of 7/64".

Intermittent Spark Ignition Safety Pilot Systems -- There are two types of intermittent spark pilots -- one type shuts off the pilot gas flow between the cycles and the other not only shuts off the pilot gas flow between cycles but also has a lockout device that stops the gas flow to the pilot if the pilot fails to light in 120 seconds. This lockout feature requires manual reset by interruption of the thermostat circuit. Propane units require the spark ignition system with the lockout device.

Ignition Controller -- As part of the intermittent safety pilot systems, the ignition controller provides the high voltage spark to ignite the pilot gas and also acts as the flame safety device. After ignition of the pilot gas, the ignition controller electronically senses the pilot flame. A low voltage DC electrical signal is imposed on the separate metal probe in the pilot assembly. The metal probe is electrically insulated from ground. The pilot flame acts as a conduction path to ground completing the DC circuit and proving pilot flame. With pilot flame proven, the ignition controller energizes the main gas valve.

If no spark occurs, check the following:

- Voltage between blue and white terminals (non-lockout type pilot) and Terminals 2 and 5 (lockout type pilot) on the ignition controller should be at least 20 volts and no higher than 32 volts. Refer to Troubleshooting (Paragraph 32) if no voltage is observed.
- Short to ground in the high tension lead and/or ceramic insulator.
- Pilot spark gap should be approximately .100". (NOTE: This model furnace manufactured prior to 11/95 had a horizontal pilot with a spark gap of 7/64".)

NOTE: When checking for spark with the pilot burner assembly removed from the burner rack, the pilot assembly must be grounded to the heater for proper spark.

If the above conditions are normal and no spark occurs, replace the ignition controller.

If the main gas valve fails to open with a normal full size pilot flame established, check for the following:

- Voltage between black and brown leads on the main gas valve is 20 to 32 VAC and there is no main gas flow with the built-in manual valve in FULL OPEN position -- the main valve is defective.

- b) No voltage between black and brown leads on the main gas valve -- check for disconnected or shorted flame sensor lead or flame sensor probe.

When the above conditions are normal and the main gas flow is still off, the ignition controller is probably defective.

25. Burners and Carryover System

These duct furnaces have individually formed steel burners with accurately die-formed ports to give controlled flame stability without lifting or flashback with either natural or propane gas. The burners are lightweight and factory mounted in an assembly which permits them to be removed as a unit for inspection or service.

All burners are equipped with two flash carryover systems that receive a supply of gas simultaneously with the main burner. During regular service, check the main burner ports, the carryover assemblies, and the orifices for cleanliness.

27. Check Installation and Start-Up

Check the installation prior to start-up:

- Check suspension. Unit must be secure and level.
 - Be certain the electrical supply matches voltage rating of the furnace. (Refer to the rating plate.)
 - Check all field wiring against the wiring diagram. Be sure wire gauges are as required for the electrical load. Verify that fuses or circuit breakers are in place and sized correctly.
 - Check clearances from combustibles. Requirements are shown in Paragraph 5.
 - If installed in a confined space, verify that the furnace has adequate combustion air supply. See Paragraph 5.
 - Check vent system to be sure that it is installed according to the instructions in Paragraph 10. Be sure to have used an approved vent terminal.
 - Check piping for leaks and proper gas line pressure. Bleed gas lines of trapped air. See Paragraph 9.
- a) Turn manual shutoff valve to off position.
 - b) Turn gas supply on.
 - c) Observe gas meter for movement, or
 - d) Attach pressure gauge readable to .1" w.c. and after turning gas on for ten seconds, turn gas supply off. No change in pressure should occur over a three-minute period.
 - e) If either c) or d) above indicate a leak, locate leak by brushing a leak-detecting solution on all fittings. Bubbles will appear at a leak. Repair and repeat tests.

26. Burner Air Adjustment

Burner air shutters are not normally required on natural gas furnaces. Air shutters are supplied on propane gas units and may require adjustment.

Before making any adjustments to the air shutters, allow the heater to operate for about fifteen minutes with the air shutters open. The slotted screw on the end manifold bracket moves the air shutters and adjusts all burners simultaneously. Turning the screw clockwise opens the shutters; counterclockwise closes the shutters. After the furnace has been in operation for 15 minutes, close the air shutters observing the flame for yellow-tipping. Open the shutters until the yellow disappears. A limited amount of yellow-tipping is permissible for propane gas. Other fuels should not display any yellow-tipping.

When making the adjustment, close the air shutters no more than is necessary to eliminate the problem condition.

DANGER: Failure to install and/or adjust air shutters according to directions could cause property damage, personal injury, and or death.

Start-Up

- Turn electric and gas supply on to the furnace. Adjust the thermostat or ductstat so that a call for heat exists. Observe for complete sequencing of safety pilot and ignition.

Check installation after start-up:

- With the unit in operation, measure manifold gas pressure. Manifold pressure for natural gas should be 3.5" w.c. and 10" w.c. for propane gas. See Paragraph 9.
- Turn the unit off and on, pausing two minutes between each cycle. Observe for smooth ignition. On two-stage or modulating burner systems, manipulate temperature adjustment slowly up and down to see if control is sequencing or modulating properly. Raising temperature setting drives burner on or to full fire.
- Observe burner flame at full fire. Natural gas flame should be about 1-1/2" in height with blue coloring. Propane gas flame should be approximately the same length with blue coloring. Yellow tipping may appear on propane gas. If yellow extends beyond 1/2 to 3/4", adjust air shutters. See Paragraph 26 .
- Checked the limit control. With the heater on, completely block off distribution air. The limit control should open within a few minutes, shutting off the gas supply to the main burners.
- Place "Owner's Envelope" containing Limited Warranty Card, this booklet, and any optional information in an accessible location near the heater. Follow the instructions on the envelope.

DANGER: The gas burner in this gas-fired equipment is designed and equipped to provide safe and economically controlled complete combustion. However, if the installation does not permit the burner to receive the proper supply of combustion air, complete combustion may not occur. The result is incomplete combustion which produces carbon monoxide, a poisonous gas that can cause death. Safe operation of indirect-fired gas burning equipment requires a properly operating vent system which vents all flue products to the outside atmosphere. FAILURE TO PROVIDE PROPER VENTING WILL RESULT IN A HEALTH HAZARD WHICH COULD CAUSE SERIOUS PERSONAL INJURY OR DEATH.

Always comply with the combustion air requirements in the installation codes and in Paragraph 5. Combustion air at the burner should be regulated only by manufacturer-provided equipment. NEVER RESTRICT OR OTHERWISE ALTER THE SUPPLY OF COMBUSTION AIR TO ANY HEATER. Indoor units installed in a confined space must be supplied with air for combustion as required by Code and in Paragraph 5 of this heater installation manual. MAINTAIN THE VENT SYSTEM IN STRUCTURALLY SOUND AND PROPERLY OPERATING CONDITION.

SERVICE AND MAINTENANCE

WARNING: If you turn off the power supply, turn off the gas. See Hazard Levels, page 2.

Maintenance Requirements -- Like all quality equipment, this unit will operate with a minimum of maintenance. However, to ensure long life and satisfactory performance, the following service schedule is recommended. When servicing, follow standard safety procedures and those specific instructions and warnings in this manual.

Furnaces should be inspected at the beginning of each heating season and then once every four (4) months where the equipment is working under normal conditions. If the furnace is located where an unusual amount of dust or soot or other impurities are contained in the air, more frequent inspection is recommended. Clean the heat exchanger (inside and outside) annually.

28. Burner Rack Removal Instructions

1. Turn off the gas supply.
2. Turn off the electric supply.
3. Remove bottom rear panel (located on the manifold side of the furnace) by removing the two screws from each side.
4. Mark and disconnect electric valve leads.
6. Uncouple the union in the gas supply.
7. Remove two sheet metal screws in the bottom of the burner rack assembly.
8. Pull "drawer-type" burner rack out of the furnace.

To disassemble the burner rack:

1. Remove flash carryover system (screws located at rear of burner drawer).
2. Remove burner hold down clamp (located inside burner drawer underneath the pilot).
3. Pull main burners horizontally away from injection opening and lift out.

Follow the instructions in Paragraph 29 to clean. To re-assemble and replace, reverse the above procedures being careful not to create any unsafe conditions.

29. Cleaning Pilot and Main Burners

Pilot - The pilot is located under the aeration panel on the control end of the burner tray and is accessible only after the burner rack assembly has been removed. In the event the pilot flame is short and/or yellow, check the pilot orifice for blockage caused by lint or dust accumulation. Remove the pilot orifice and clean with air pressure. **DO NOT REAM THE ORIFICE.** Check and clean the aeration slot in the pilot burner.

Clean the metal sensing probe and the pilot hood with an emery cloth and wipe off the ceramic insulator. Check the spark gap; spark gap should be maintained to .100". After the pilot is cleaned, blow any dirt away with compressed air. The combination valve includes a pilot adjustment screw. To adjust, remove cap screw and adjust the pilot flame to approximately 1-1/4".

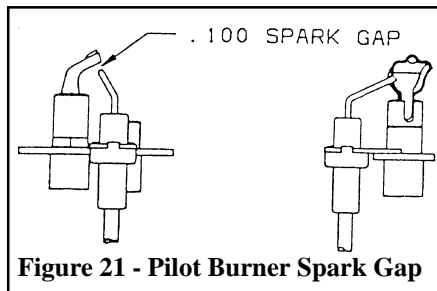

Figure 21 - Pilot Burner Spark Gap

Pilot System - No periodic maintenance of the ignition control box is required. However, each season the lead wires should be checked for insulation deterioration and good connections. Proper operation of the electronic spark ignition system requires a minimum flame signal of 0.2 microamps as measured by a microampmeter. Do not attempt to

CAUTION: When cleaning, wearing eye protection is recommended.

Figure 22 -- Vertical Spark Pilot

When re-installing the pilot, be sure to include the pilot hole cover plate.

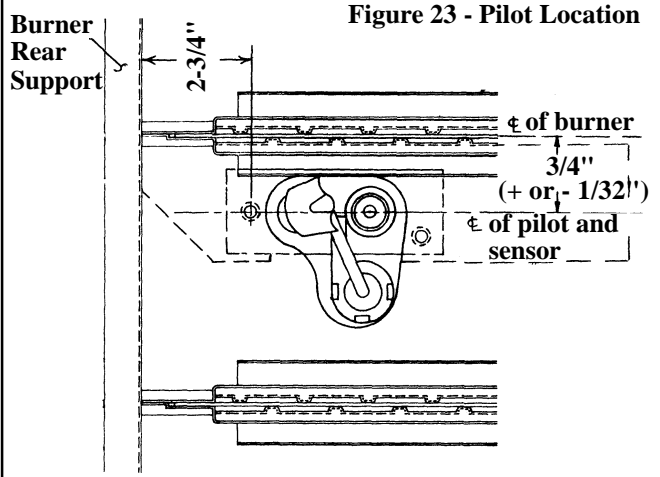
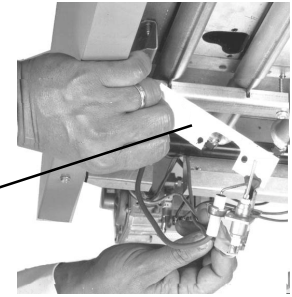

Figure 23 - Pilot Location

disassemble the ignition controller. There are no field replaceable components in the control enclosure.

CAUTION: Due to high voltage on pilot spark wire and pilot electrode, do not touch when energized. See Hazard Levels, page 2.

Burners - Normally it is unnecessary to clean the main burners but during the annual cleaning of the heat exchanger tubes it is wise to inspect the burners for plugged ports. Main burners may be cleaned using air pressure. Use an air nozzle to blow out scale and dust accumulation from the burner ports. Alternately blow through the burner ports and the venturi. Use a fine wire to dislodge any stubborn particles. Do not use anything that might change the port size.

Clean the burner rack flash carryover systems with air pressure.

Burner Orifices for Sea Level Operation					
Size	Qty	Natural Gas		Propane Gas	
		Drill Size	P/N	Drill Size	P/N
75	4	45	38678	1.2 mm	63003
100	4	41	11792	1.45 mm	61652
125	5	41	11792	1.45 mm	61652
140	5	38	45870	1.55 mm	61653
170	6	38	45870	1.55 mm	61653
200	7	38	45870	1.55 mm	61653
225	8	38	45870	1.55 mm	61653
250	9	39	45871	1.55 mm	61653
300	11	39	45871	53	9789
350	13	39	45871	53	9879
400	15	39	45871	53	9879

NOTE: Use only factory-authorized replacement parts.

30. Cleaning the Heat Exchanger

CAUTION: When cleaning, wearing eye protection is recommended.

Outer Surfaces (circulating air side) - To clean the outer surfaces of the heat exchanger, gain access by removing the inspection panels in the ductwork or remove the ductwork. Depending on whether or not the furnace is designed for high CFM (Model prefix "H"), there may be directional baffles between the heat exchanger tubes. The standard furnace has baffles between the heat exchanger tubes as shown in Figure 3B, page 5. (High CFM furnaces have only the top baffle support which does not need to be removed for cleaning.)

To remove the baffles, remove the screws marked "A" in Figure 3B, and slide each baffle forward. Use a brush and/or an air hose to remove accumulated dust and grease deposits from the heat exchanger tubes and the baffles. Re-install the baffles by sliding them into the rear slot and replacing the screw. Secure ductwork as necessary.

Inner Surfaces (combustion gas side) - The inner surfaces of the heat exchanger can be reached for cleaning with the burner rack removed (See Paragraph 28.) An air hose; a long (18 to 24-inch), 1/2" diameter stiff brush; a flashlight; and a mirror are needed. The required procedure depends on the size of the furnace and the date of manufacture. Follow these instructions to clean the inner surfaces of the heat exchanger.

All Sizes 75, 100 and 125 (do not have heat exchanger "V" baffles) and Sizes 140-400 manufactured prior to 11/95 (do not have heat exchanger "V" baffles) -- Remove the burner rack assembly. Use a furnace brush (or a piece of heavy wire to which a piece of steel wool is attached). Brush up and down within the tubes until all soot is removed. With an air hose or brush, clean the outside space between the lower portions of the heat exchanger tubes to remove any accumulated dust or light deposits.

Sizes 140 - 400 manufactured beginning 11/95 (have heat exchanger "V" baffles) -- Remove the burner rack assembly. Make sure that the flue pipe is supported. Remove the three screws that attach the venter housing to the outlet duct (pipe from furnace to venter). The venter assembly will remain in place. Remove the six screws used to attach the flue collection box to the top of the furnace. Remove the flue collection box exposing the heat exchanger tubes. The V-shaped tube baffles can now be removed.

All Sizes -- After cleaning is complete, reverse the procedure to re-assemble the furnace. Use extreme care so that no unsafe conditions are created. **Check the furnace for proper operation.**

31. Venter

Motor - Remove dirt from the outer surface. The venter motor is permanently lubricated; no oiling is required.

Venter Relay - The venter relay controls the venter motor. If relay contacts fail to "make", the venter motor will not run. If relay contacts fail to "open", the venter motor will not shut off.

32. Troubleshooting

TROUBLE	PROBABLE CAUSE	REMEDY
Venter motor will not start	<ol style="list-style-type: none"> 1. No power to unit. 2. No 24 volt power to venter relay. 3. Venter relay defective. 4. Defective motor or capacitor. 	<ol style="list-style-type: none"> 1. Turn on power, check supply fuses, or circuit breaker. 2. Turn up thermostat; check control transformer output. Check for loose wire connections. 3. Replace relay. 4. Replace motor or capacitor.
Pilot will not light (venter operating)	<ol style="list-style-type: none"> 1. Manual valve not open. 2. Air in gas line. 3. Dirt in pilot orifice. 4. Gas pressure too high or too low. 5. Kinked pilot tubing. 6. Pilot valve does not open. 7. No spark: <ol style="list-style-type: none"> a) Loose wire connections b) Transformer failure. c) Incorrect spark gap. d) Spark cable shorted to ground. e) Spark electrode shorted to ground. f) Drafts affecting pilot. g) Ignition control not grounded. h) Faulty ignition controller. 8. Optional lockout device interrupting 9. Faulty combustion air proving 	<ol style="list-style-type: none"> 1. Open manual valve. 2. Bleed gas line. 3. Remove and clean with compressed air or solvent (do not ream). 4. Adjust supply pressure. (See Paragraph 9). 5. Replace tubing. 6. If 24 volt available at valve, replace valve. 7. <ol style="list-style-type: none"> a) Be certain all wires connections are solid. b) Be certain 24 volts is available. c) Maintain spark gap at .100". d) Replace worn or grounded spark cable. e) Replace pilot if ceramic spark electrode is cracked or grounded. f) Make sure all panels are in place and tightly secured to prevent drafts at pilot. g) Make certain ignition control is grounded to furnace chassis h) If 24 volt is available to ignition controller and all other causes have been eliminated, replace ignition control. 8. Reset lockout by interrupting control at thermostat. 9. Replace combustion air proving switch.
Pilot lights, main valve will not open	<ol style="list-style-type: none"> 1. Manual valve not open. 2. Main valve not operating. <ol style="list-style-type: none"> a) Defective valve. b) Loose wire connections. 	<ol style="list-style-type: none"> 1. Open manual valve. 2. <ol style="list-style-type: none"> a) If 24 volt is measured at valve connections and valve remains closed, replace valve. b) Check and tighten all wiring connections.

(Troubleshooting is continued on page 24.)

32. Troubleshooting (cont'd)

TROUBLE (cont'd)	PROBABLE CAUSE (cont'd)	REMEDY (cont'd)
Pilot lights, main valve will not open (cont'd)	3. Ignition control does not power main valve. a) Loose wire connections. b) Flame sensor grounded. (Pilot lights - spark continues) c) Gas pressure incorrect. d) Cracked ceramic at sensor. e) Faulty ignition controller.	3. a) Check and tighten all wiring connections. b) Be certain flame sensor lead is not grounded or insulation or ceramic is not cracked. Replace as required. c) Set supply pressure at 5" w.c. to 14" w.c. for natural gas and 11" w.c. to 14" w.c. for propane gas. d) Replace sensor. e) If all checks indicate no other cause, replace ignition controller. Do not attempt to repair ignition controller; it has no field replaceable components.
No heat (Heater Operating)	1. Dirty Filters 2. Incorrect manifold pressure or orifices. 3. Cycling on limit control. 4. Improper thermostat location or adjustment. 5. Belt slipping on blower.	1. Clean or replace filters. 2. Check manifold pressure (See Paragraph 9). 3. Check air throughput (See Paragraph 15). 4. See thermostat manufacturer's instructions. 5. Adjust belt tension.
Cold air delivered On Start-up	1. Fan control improperly located or adjusted. 2. Defective fan control.	1. Relocate or adjust fan control (See Paragraph 19). 2. Replace fan control.
During Operation	3. Blower set for too low temperature rise. 4. Incorrect manifold pressure.	3. Slow down blower or increase static pressure.. 4. Check manifold line pressure (See Paragraph 9).
Motor will not run	1. Circuit open. 2. Fan control inoperative. 3. Defective motor or capacitor.	1. Check wiring and connections. 2. Replace fan control. 3. Replace motor or capacitor.
Motor turns on and off while burner is operating (See "Motor..." below)	1. Fan control improperly located or adjusted. 2. Defective fan control. 3. Motor overload device cycling on and off. 4. 3 phase motor rotating in opposite	1. Relocate or adjust fan control (See Paragraph 19). 2. Replace fan control. 3. Check motor load against motor rating plate. Replace motor if needed. 4. Interchange 2 legs on supply connections.
Blower motor cuts out on overload	1. Improper motor pulley and/or adjustment. 2. Improper static pressure in the duct system. 3. Low voltage.	1. See instructions on air throughput. 2. Adjust duct system dampers. 3. Check power supply.

FOR SERVICE OR REPAIR, FOLLOW THESE STEPS IN ORDER:

FIRST:	Contact the installer.
Name	_____
Address	_____ _____ _____
Phone	_____
SECOND:	Contact the nearest distributor (See telephone Yellow Pages.)
THIRD:	Contact: REZNOR®, Thomas & Betts Corporation 150 McKinley Avenue Mercer, PA 16137 Phone: (724) 662-4400
Model No.	_____
Unit Serial No.	_____
Date of Installation	_____