

Panasonic

Hi-Fi

Professional/Industrial Video

Model AG-**7350** -B
-E

Model AG-**7150** -B
-E

S VHS VHS
625 PAL

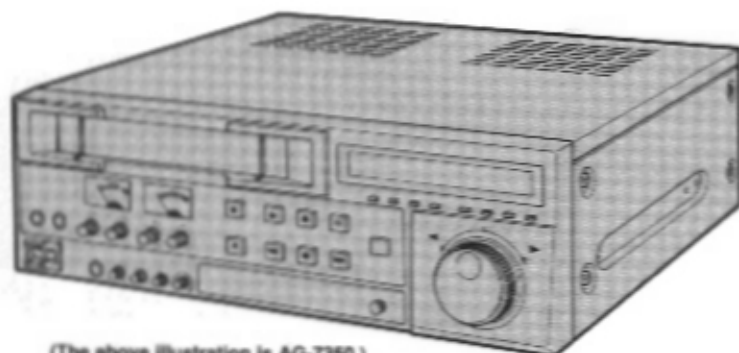

(The above illustration is AG-7350.)

Before attempting to connect, operate or adjust this product, please read these instructions completely.

Operating Instructions

Introduction	2
Precaution for Use	3
Table of Contents	4
Controls and Their Functions	6
Switch Settings	11
Basic Operations	14
Recording Operations	21
Playback Operations	26
Dubbing	29
Time Code	33
Audio Dubbing	34
ON-SCREEN Function	36
Troubleshooting	42
Options	44
Others	46

Introduction

Thank you very much for purchasing the AG-7350/AG-7150. This is a VTR which was developed for applications in industry, educational establishments and studios.

These Operating Instructions are for use both with model AG-7350 and model AG-7150.

Amorphous heads and high quality picture

Picture quality has been improved by the use of the S-VHS system and the amorphous heads. Resolution of over 400 lines and less noise are realized in the following condition.

- FM carrier frequency: White peak; 7 MHz
 Sync tip; 5.4 MHz
- Installation of sub-emphasis circuit
- White clip level: 210%
- Use of S-VHS tape

Highly dependable mechanisms

- GT4W Head System enables double fine slow motion.
- The data in the counter memory can be backed up in the event of a power failure for about 48 hours.
- As for the full loading system, playback operation starts instantly from stop mode after the button is pressed.
- Sensor recording automatically records the input signal from the video input connector. (AG-7350 only)

Full range of options for system expansion

- Remote control is available using the optional remote search controller AG-A600 (34P).
- The optional Interface Adaptor allows control capability by RS-232C remote control.
For details, contact your authorized service personnel.

Precautions for Use

IMPORTANT (AG-7350 only)

"Unauthorized recording of copyrighted television programmes, films, video tapes and other materials may infringe the right of copyright owners and be contrary to copyright laws."

■ THIS APPARATUS MUST BE EARTHED.

To ensure safe operation the three-pin lead supplied (not for U.K. model) must be connected only into a standard three-pin power point which is effectively earthed through the normal household wiring.

Extension cords used with the equipment must be three-core and be correctly wired to provide connection to earth. Wrongly wired extension cords are a major cause of fatalities.

The fact that the equipment operates satisfactorily does not imply that the power point is earthed and that the installation is completely safe. For your safety, if in any doubt about the effective earthing of the power point, consult a qualified electrician.

■ DO NOT REMOVE PANEL COVER BY UNSCREWING.

To reduce the risk of electric shock, do not remove cover. No user serviceable parts inside. Refer servicing to qualified service personnel.

- If the unit is not going to be used for length of time, turn the power OFF and disconnect the power plug from the AC outlet.

WARNING:

TO REDUCE THE RISK OF FIRE OR SHOCK HAZARD, DO NOT EXPOSE THIS EQUIPMENT TO RAIN OR MOISTURE.

■ AC POWER CORD CONNECTION (U.K.model only)

The wires in the mains lead for this apparatus are coloured in accordance with the following code.

Important

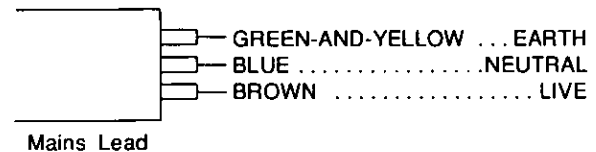

As the colours of the wires in the mains lead of this apparatus may not correspond with the coloured markings identifying the terminals in your plug proceed as follows:

The wire which is coloured GREEN-AND-YELLOW must be connected to the terminal in the plug which is marked by the letter E or by the safety earth symbol \perp or coloured GREEN or GREEN-AND-YELLOW.

The wire which is coloured BLUE must be connected to the terminal which is marked with the letter N or coloured black.

The wire which is coloured BROWN must be connected to the terminal which is marked with the letter L or coloured red.

CAUTION:

TO REDUCE THE RISK OF FIRE OR SHOCK HAZARD AND ANNOYING INTERFERENCE, USE THE RECOMMENDED ACCESSORIES ONLY.

Remark:

This apparatus was produced to BS 800.

Dieses Modell entspricht der EG-Vorschrift(für Funkstörungsschutz) 87/308/EWG.

La Société PANASONIC-FRANCE, importateur du matériel MATSUSHITA-JAPON déclare que cet appareil est conforme aux prescriptions de la directive 76/889/C.E.E. modifiée par la directive 87/308/C.E.E.

Dit model is onderworpen aan de EEG-richtlijn (ter voorkoming van radio-interferentie) 87/308/EEG.

Denne model opfylder EF direktiv 87/308/EF (for forebyggelse af radiointerferens).

La Società PANASONIC ITALIA S.p.A., importatrice di questo prodotto, dichiara che questo apparecchio è conforme alle disposizioni della direttiva C.E.E./87/308 (D.M. 13.4.1989).

Este modelo cumple con la norma EC (para interferencias de radio 87/308/EEC).

 is the safety information.

Table of contents

Controls and Their Functions

Front Panel Parts	6
Rear Panel Parts	9

Switch Settings

Setting the Switches	11
1. CH2 METER Selector (AG-7350 only)	11
2. AUDIO MONITOR Selector	11
3. METER Selector	11
4. AUDIO OUT Selector	11
5. SENSOR REC Selector (AG-7350 only)	12
6. EXT TIMER Selector	12
7. MODE LOCK Selector	12
8. INPUT Signal Selector (AG-7350 only)	13
9. SYNC Selector	13
10. TV SYSTEM Selector	13

Basic Operations

Recording (AG-7350 only)	14
Playback	16
FF, REW, Stop and Pause/Still	18
Search Operations	19
MEMORY STOP Function	20

Recording Operations

Sensor Recording (AG-7350 only)	21
Timer Recording (AG-7350 only)	22
Camera Recording (AG-7350 only)	24

Playback Operations

Timer Playback	26
Repeat Playback	28

Dubbing

Dubbing	30
---------------	----

Time Code

Time Code	33
-----------------	----

Audio Dubbing

Audio Dubbing (AG-7350 only)	34
------------------------------------	----

ON-SCREEN Function

ON-SCREEN (Memory Setting)	36
ON-SCREEN (Initial Setting)	38

Troubleshooting

Error Displays	42
Troubleshooting	43

Options

Controller (Option)	44
Rack Mount Adaptor (Option)	45

Others

Connector Signals	46
Accessories	47
Notes for Video Cassette	48
Regular Inspections	49
Specifications	50

Front Panel Parts

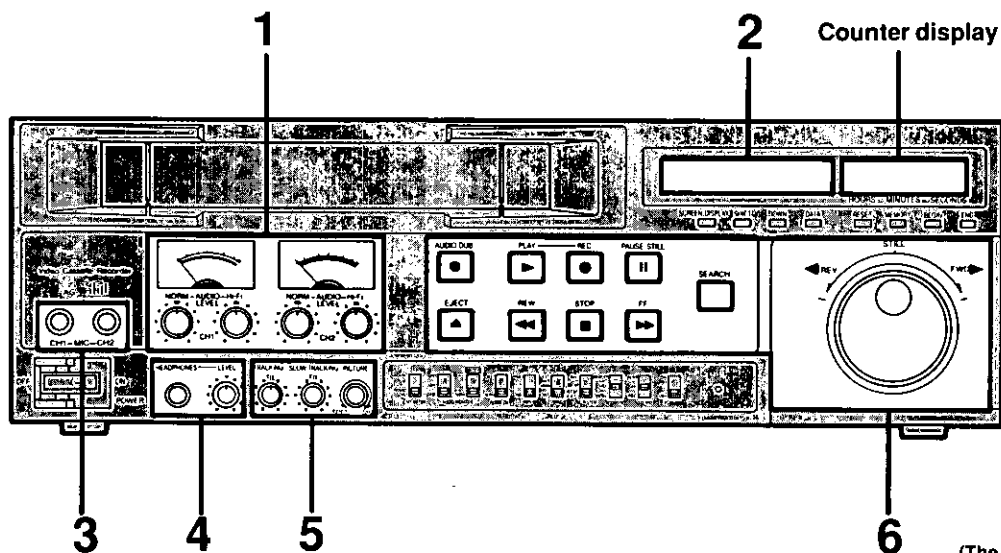





(The above illustration is AG-7350.)

1 Level control area (AG-7350 only)

Audio (CH1) level meter	Displays CH1 audio level.
Audio (CH2) level meter	Displays CH2 audio level or tracking level.
Audio (CH1) NORMAL LEVEL control	Adjusts recording level for normal audio CH1.
Audio (CH1) Hi-Fi LEVEL control	Adjusts recording level for Hi-Fi audio CH1.
Audio (CH2) NORMAL LEVEL control	Adjusts recording level for normal audio CH2.
Audio (CH2) Hi-Fi LEVEL control	Adjusts recording level for Hi-Fi audio CH2.

2 Function display lamp area

Cassette "IN" lamp ()	Lights when a cassette is inserted.
S-VHS lamp ()	Lights in S-VHS mode.
Hi-Fi lamp	Lights when Hi-Fi sound is recorded or played back.
DOLBY* NR lamp	Lights when Dolby NR system is used.
SENSOR lamp (AG-7350 only)	Lights when SENSOR REC switch is ON. Flashes when no tape is inserted or tape with broken removable tab is inserted with the SENSOR REC switch set to ON.
"6H" lamp	Lights when played back in 6H mode (EP).
One-time playback lamp ()	Lights in one-time repeated playback mode.
Memory stop lamp ()	Lights in counter (0:00:00) stop mode.
Continuous playback lamp ()	Lights in continuous repeated playback mode.

* Dolby noise reduction manufactured under license from Dolby Laboratories Licensing Corporation.

* "DOLBY" and the double-D symbol  are trademarks of Dolby Laboratories Licensing Corporation.

3 Microphone area (AG-7350 only)

MIC jacks (CH1/CH2) Connects 1/4" external microphone.

4 Headphone area

HEADPHONE jack Connects 1/4" stereo headphones.
HEADPHONE LEVEL control Adjusts headphones volume.

5 Picture adjusting area

TRACKING control Adjusts tracking.
SLOW TRACKING control Adjusts slow motion tracking.
PICTURE adjusting knob Adjusts picture sharpness during playback.

6 Basic operation area

AUDIO DUB button (AG-7350 only) Starts audio dubbing when used together with PLAY button during playback.
PLAY button Starts playback.
REC button (AG-7350 only) Starts recording when used together with PLAY button.
PAUSE/STILL button Establishes still-picture mode during playback and pause mode during recording.
EJECT button For ejecting the cassette.
REW button Rewinds the tape.
STOP button Stops all operations.
FF button Fast forwards the tape.
SEARCH button Executes and releases search.
Search/JOG dial Adjusts search speed.

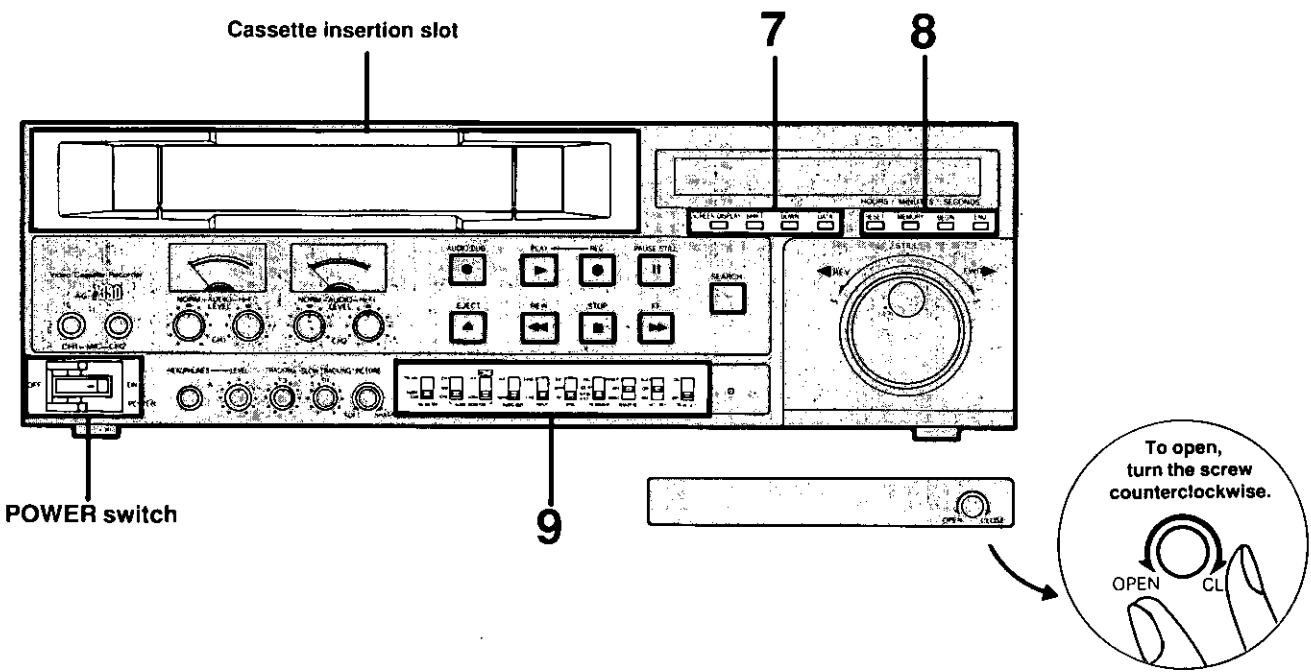

7 Menu setting area

SCREEN DISPLAY button	Displays initial setting menu on the screen.
SHIFT button	Changes the menu pages and shifts the flashing of the indicator rightward.
DOWN button	Shifts the flashing of the line indicator downward.
DATA button	Inputs the digit data and selects the data.

8 Function setting area

RESET button	Resets the tape counter.
MEMORY button	Sets the memory auto stop and selects the repeat mode.
BEGIN button	Sets the repeat beginning point.
END button	Sets the repeat ending point.

9 Function setting area

CH2 METER selector	Selects between Audio CH2 Level Meter and Tracking Meter for Audio (CH2) level meter.
AUDIO MONITOR meter selectors	Selects type of sound and channel to be monitored.
AUDIO OUT selector	Selects type of sound to be output from Audio Output Jacks.
INPUT signal selector (AG-7350 only)	Selects video input signal.
SYNC mode selector	Selects type of signal to be synchronized.
SENSOR REC selector (AG-7350 only)	Selects the mode to be recorded automatically.
EXT TIMER selector	Selects timer mode.
MODE LOCK selector	Inhibits function of the front panel buttons.
TV SYSTEM selector	Selects the 3 VHS system, PAL, CCIR and NTSC 4.43.

Rear Panel Parts

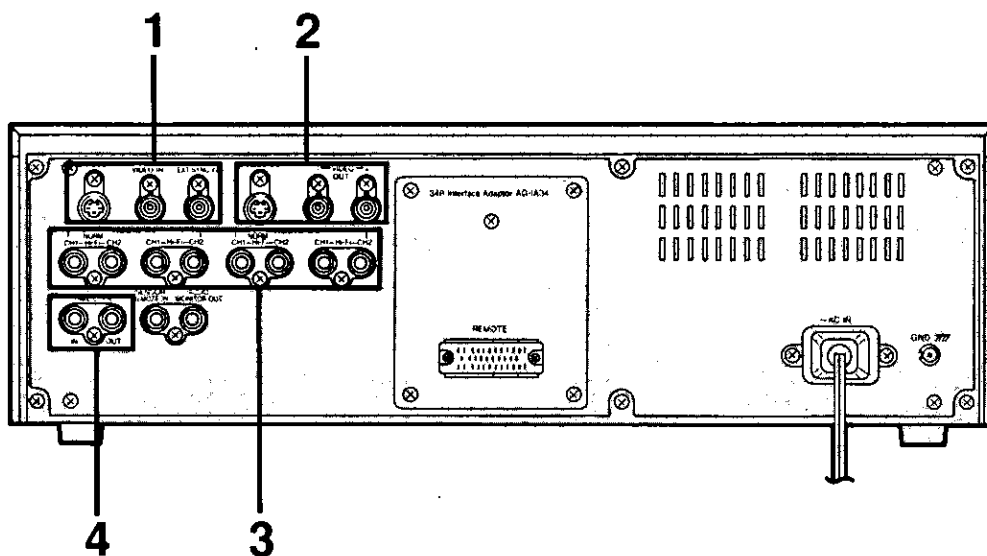

1 Video input signal area

- S-VIDEO IN connector (AG-7350 only) S-VIDEO signal input connector.
- VIDEO IN connector (AG-7350 only) Video signal input connector.
- EXT SYNC IN connector To synchronize with the external reference synchronizing signal.

2 Video output signal area

- S-VIDEO OUT connector S-VIDEO signal output connector.
- VIDEO OUT (1, 2) connectors Video signal output connectors.

3 Audio signal area

- NORM/Hi-Fi audio input connectors NORM/Hi-Fi audio (CH1/2) input connectors.
(AG-7350 only)
- Hi-Fi audio input connectors Input connectors for Hi-Fi sound only.
(AG-7350 only)
- NORM/Hi-Fi audio output connectors NORM/Hi-Fi audio (CH1/2) output connectors.
- Hi-Fi audio output connectors Output connectors for Hi-Fi sound only.

4 Time code signal area

- TIME CODE IN connector (AG-7350 only) Time Code signal input connector.
- TIME CODE OUT connector Time Code signal output connector.

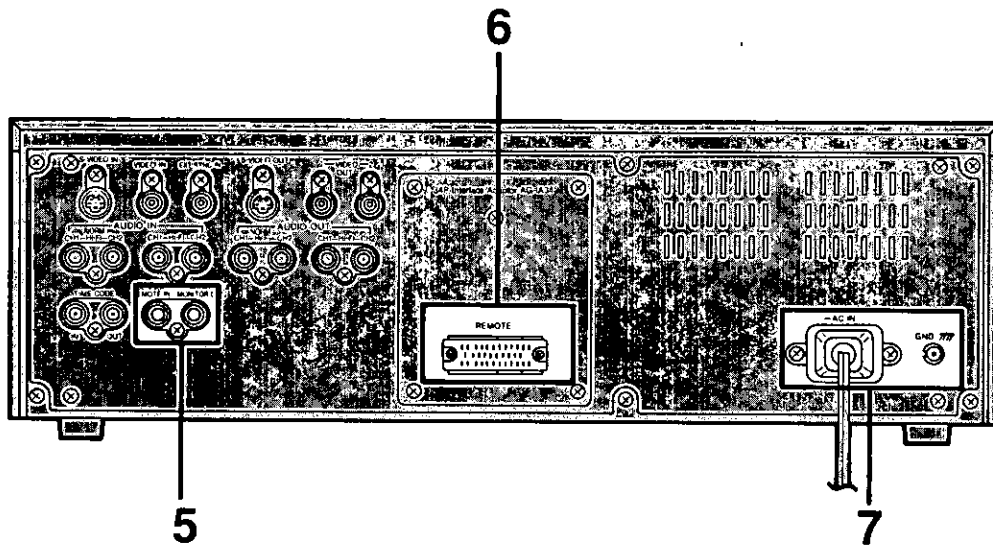

5 Sensor remote recording/Monitor output area

SENSOR REMOTE connector (AG-7350 only) . . . Sensor remote signal recording connector.
AUDIO MONITOR OUT connector Audio monitor signal output connector.

6 Remote signal area

REMOTE connector Connector for remote search controller (AG-A600).

7 Power supply circuit area

AC IN socket Connected to AC 120-240V power outlet.
GND terminal When connecting this unit to any other component, make absolutely sure that it is properly grounded by connecting this terminal.

Setting the Switches

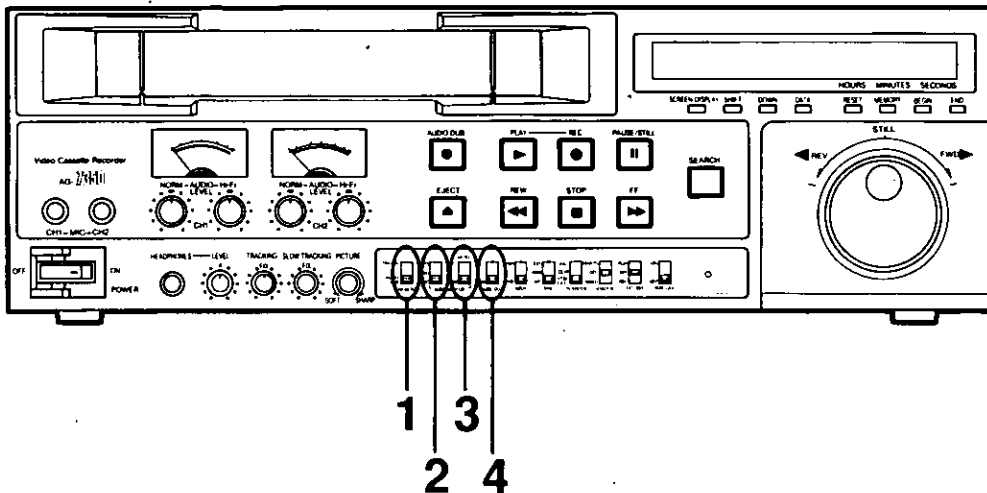

(The above illustration is AG-7350.)

1. CH2 METER Selector (AG-7350 only)

Used to adjust the audio (CH2) input level during recording. Set this selector to "AUDIO CH2" before making adjustment for the recording level of audio channel 2.



2. AUDIO MONITOR Selector

Used to select the audio channel which is to be heard on the TV monitor or headphones through the HEADPHONE Jack on the front panel or the AUDIO MONITOR OUT connector on the rear panel of the unit.

- CH1:** To monitor the audio signal from channel 1.
- MIX:** To monitor the mixed audio signals from channels 1 and 2 through the AUDIO MONITOR OUT connector or HEADPHONES Jack. When using headphones, audio channels 1 (left) and 2 (right) can be monitored separately.
- CH2:** To monitor the audio signal channel 2.

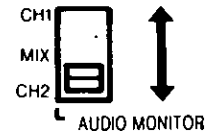

3. METER Selector (No LEVEL meter for AG-7150.)

Used to display the recording level of Hi-Fi audio or normal audio on the LEVEL meter and select the audio output signal from the HEADPHONES Jack on the front panel or the AUDIO MONITOR OUT connector on the rear panel.

- Hi-Fi:** Selects Hi-Fi audio.
- NORM:** Selects normal audio.

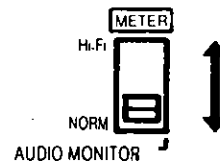

4. AUDIO OUT Selector

Used to select the audio output signal from the NORM/Hi-Fi audio output connectors on the rear panel.

- Hi-Fi:** Discriminates between Hi-Fi and normal audio automatically. When there is no Hi-Fi audio output signal, normal audio will be automatically outputted.
- NORM:** Normal audio is outputted.

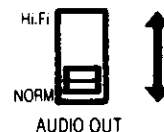

Setting the Switches (cont.)

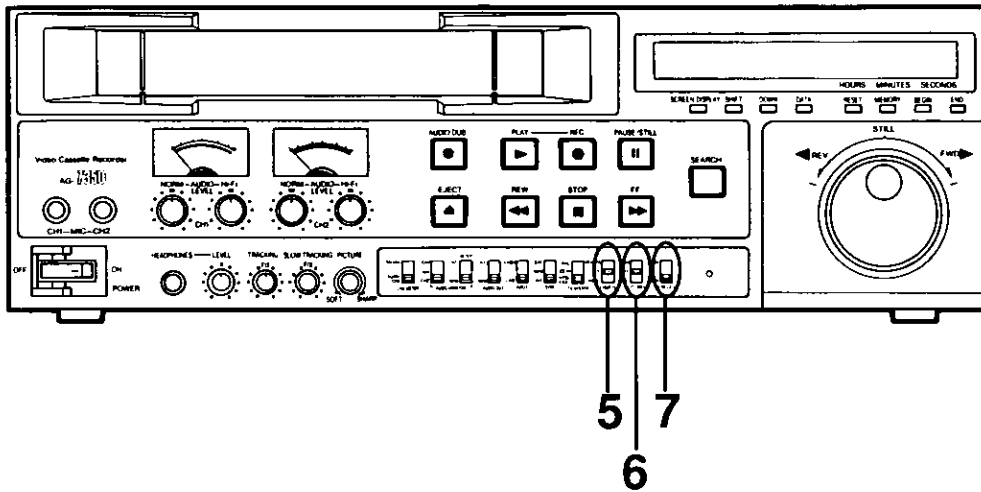

5. SENSOR REC Selector (AG-7350 only)

Used to select the mode to be recorded automatically.

REMOTE: To perform automatic recording of control signal from the connector at rear panel.

OFF: Normally, set this switch to this position.

VIDEO: To detect the video input signal from the VIDEO IN connector and record automatically.



6. EXT TIMER Selector

Used to perform timer recording or playback.

PLAY: To perform timer playback with an external timer.

OFF: Normally, set this switch to this position.

REC: To perform timer recording with an external timer.

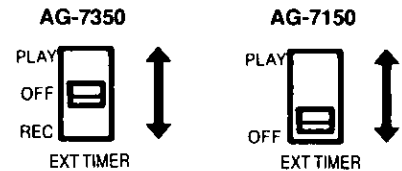

7. MODE LOCK Selector

ON: To operate the unit with a remote controller. When this switch is set to this position, the operation buttons on the front panel of the unit will be rendered inoperative.

OFF: When this switch is set to this position, the operation buttons on the front panel are operative and the unit can also be controlled with the remote controller.

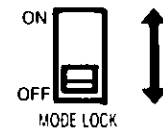

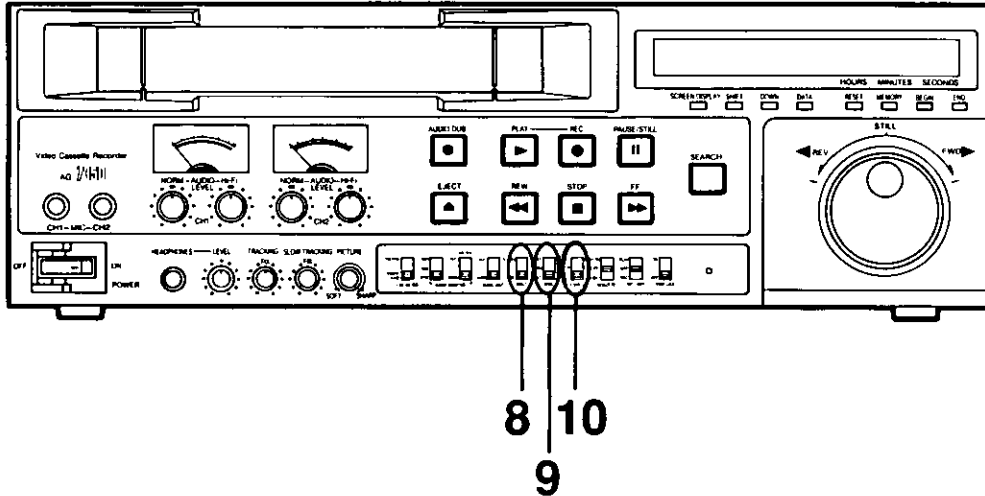

8. INPUT Signal Selector (AG-7350 only)

Used to select video input signal to be recorded.

S-VIDEO: To record video signal through the S-VIDEO IN Connector.

LINE: To record video signal through the VIDEO IN Connector.

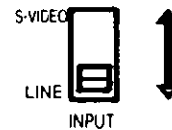

9. SYNC Selector

Select the synchronizing signal.

EXT: To synchronize to the external composite sync signal transmitted through the EXIT SYNC IN Connector during playback or recording.

NORM: To synchronize to the video input signal transmitted from the VIDEO IN Connector. (If there is no video input signal, the "INT" mode will be selected.)

INT: To synchronize to the internal oscillator built in this unit. (During recording, it will be automatically synchronized to the video input signal.)

■ When setting to "EXT", be sure to input an external composite sync signal.

AG-7350

AG-7150

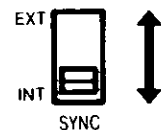
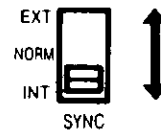

10. TV SYSTEM Selector

Used to select the 3 VHS system.

PAL: To playback or record by PAL system.

CCIR: To playback or record by CCIR system. (S-VHS recording can not be made.)

NTSC

4.43: To playback tapes recorded by NTSC system. (Recording cannot be performed.)



- PAL and CCIR systems can not be distinguished automatically.
- If REC and PLAY Buttons are pressed simultaneously when this selector is set to "NTSC 4.43", the unit will automatically go into playback mode.

Recording (AG-7350 only)

Model AG-7150 is not equipped with recording function.

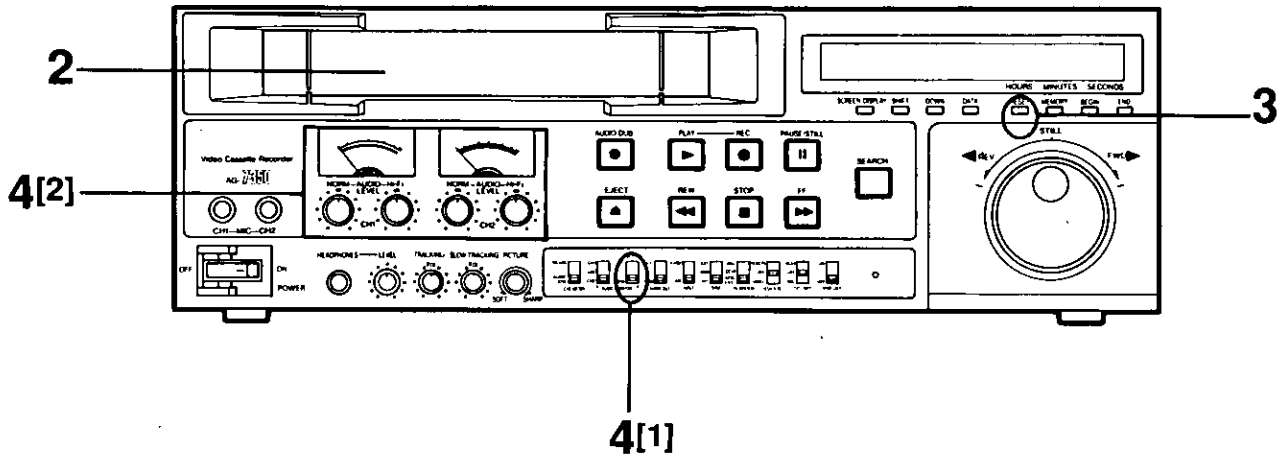

1. Set the selectors.

- INPUT Selector → "LINE" or "S-VIDEO" (Refer to page 13.)
- SENSOR REC Selector → "OFF" (Refer to page 12.)
- EXT TIMER Selector → "OFF" (Refer to page 12.)
- S-VHS (ON-SCREEN) → "ON" (Refer to pages 38 to 40.)

2. Insert the video cassette.

- Make sure that the erasure prevention tab on the video cassette is intact.

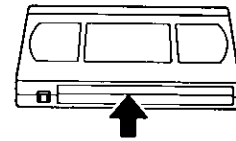

3. Press the RESET Button.

- The tape counter will be cleared.

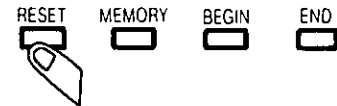

4. Adjust the audio recording level.

[1] Select Hi-Fi audio or normal audio to be adjusted with the METER Selector.

HI-FI: Hi-Fi audio recording level is displayed on the LEVEL meter.

NORM: Normal audio recording level is displayed.

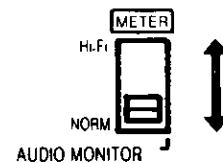

[2] Level adjustment

Adjust the recording level of Hi-Fi audio or normal audio by rotating the audio level controls (CH1 and CH2) until the LEVEL meter point their maximum positions below "0".

- Be sure to set the "AUDIO LIMITER" mode in the initial setting menu on the TV monitor (ON-SCREEN) to "OFF" before adjusting the normal audio recording level.

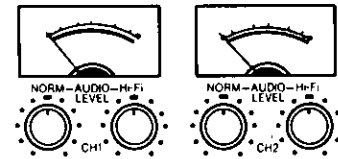

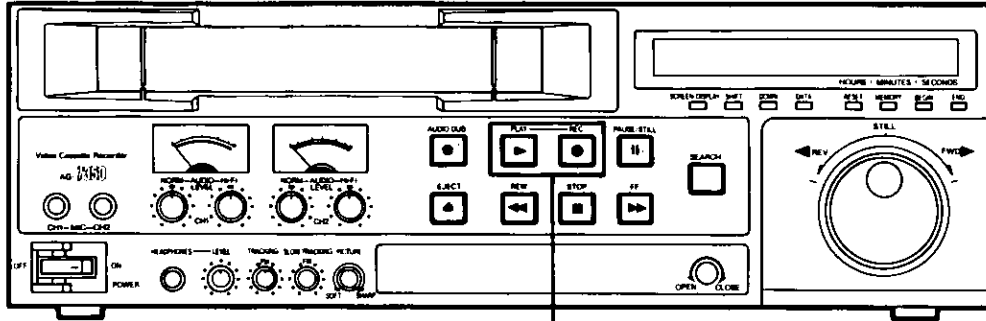

5

5. Press the REC and PLAY Buttons together.

- Recording will start.

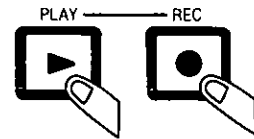

Notes

- The AUDIO LIMITER function and the DOLBY NR system's initial settings can be selected in the ON-SCREEN mode.
 - When the AUDIO LIMITER function is set "ON", the automatic volume control circuit in the unit permits audio recording with less distortion at peak levels.
 - The DOLBY NR system permits audio recording and playback with less noise.
- Set the "HI-FI REC" mode in the initial setting menu on the TV monitor (ON-SCREEN) to "ON" to perform Hi-Fi audio recording.
- If Hi-Fi audio recording is not intended, be sure to not only set the LEVEL meter to "0", but also the "HI-FI REC" mode of the ON-SCREEN to "OFF".



Playback

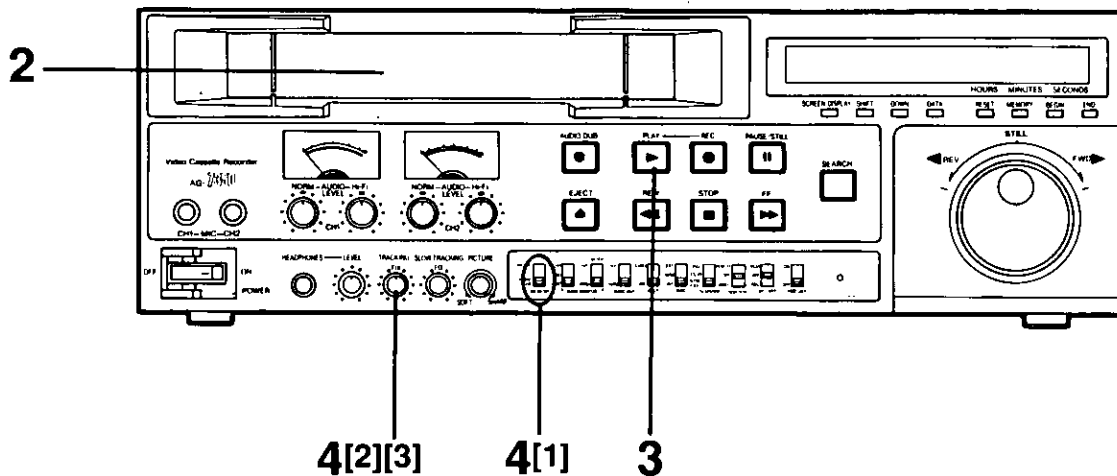

1. Set the selectors.

- SENSOR REC Selector → "OFF" (AG-7350 only) (Refer to page 12.)
- EXT TIMER Selector → "OFF" (Refer to page 12.)

2. Insert the video cassette.

- Insert the tape with the recorded sound and pictures which are to be played back.

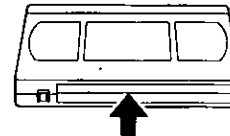

3. Press the PLAY Button.

- Playback will start.



4. Adjust the Tracking.

- [1] Set the CH2 METER Selector to "TRACKING". (AG-7350 only)



- [2] In case of AG-7350:
Slowly rotate the TRACKING Control clockwise or counter-clockwise so that the meter deflection is maximized.

In case of AG-7150:
Slowly rotate the TRACKING Control clockwise or counter-clockwise to reduce the noise for a normal image.

- [3] Return the TRACKING Control to its center "FIX" position after playback is finished.



- TRACKING should be readjusted when playing back tapes recorded on another VTR.

When using the headphones

If a high-impedance headphones is used, the volume level may be variable.

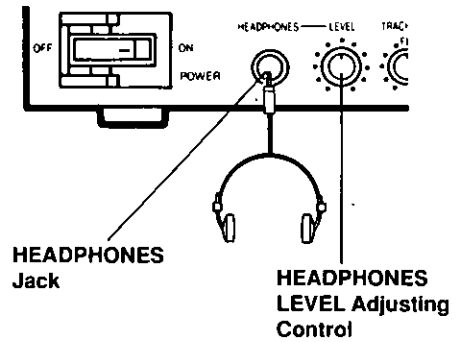

Vertical Lock Adjustment

If picture jitters vertically in STILL, adjust the V-Lock Control (at the Bottom Panel), but a one time adjustment should be necessary.

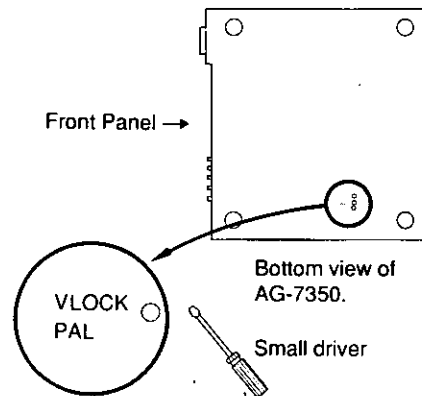

Notes

- Set the "DOLBY NR" mode in the ON-SCREEN (initial setting) menu to "ON" to playback a tape recorded in the Dolby NR system. (Refer to pages 38 to 41.)
- If TRACKING is not adjusted properly for playback, Hi-Fi audio recorded onto the tape will not be reproduced and the Hi-Fi lamp will not be displayed.

FF, REW, Stop and Pause/Still

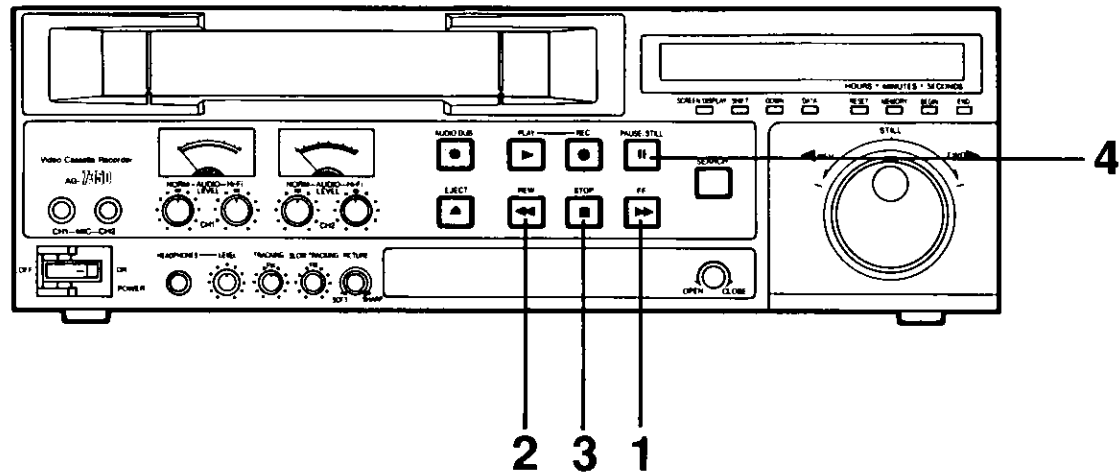

1. Fast forwarding the tape

Press the FF button.



2. Rewinding the tape

Press the REW button.

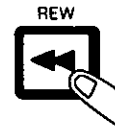

3. Stopping the tape

Press the STOP button.

- The STOP button lights and all operations are stopped.

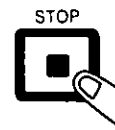

4. Pause

Press the PAUSE/STILL button during recording or playback.

- During playback, the unit is placed in the PLAY/STILL mode and still pictures are played back.
- During recording, the unit is placed in the REC/PAUSE mode and recording is temporarily suspended.



Notes

- If PAUSE/STILL mode continues for more than about 5 minutes, the unit will automatically go into the stop mode to prevent the tape from damage.
- If STOP mode continues for more than about 5 minutes, the cylinder will automatically stop to prevent the tape from damage.

Search Operations

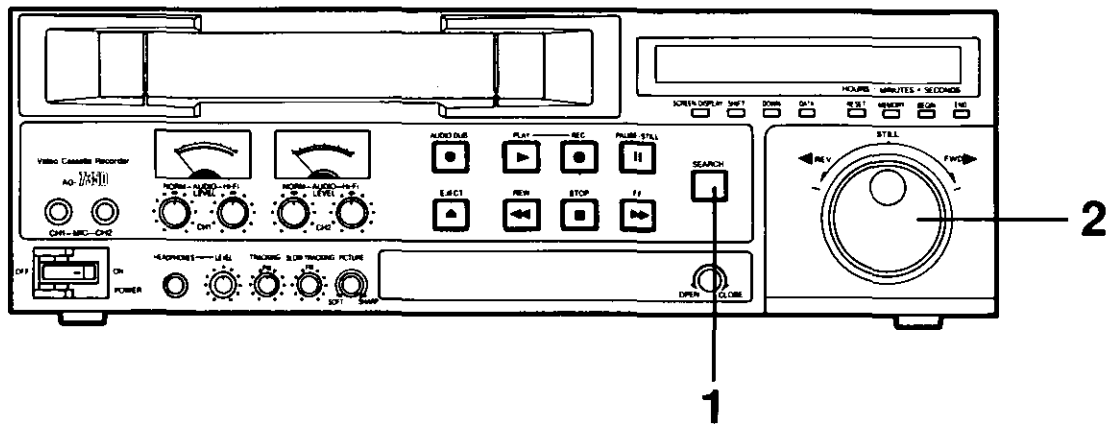

1. Press the **SEARCH** Button.

The **SEARCH**, **PLAY** and **PAUSE/STILL** Buttons' indicators will light up. Then the unit goes into the **SEARCH** standby mode.



2. Operate the **SEARCH/JOG** Dial.

The inner part dial is **JOG** mode while the outer part dial is **SHUTTLE** mode.

- When the **SEARCH/JOG** Dial is rotated clockwise, the tape will be played back in the forward direction (the **FWD** indicator appears). When it is rotated counterclockwise, the tape will be played back in the reverse direction (the **REV** indicator appears).

[1] **JOG** mode

In response to the speed at which the inner part dial is turned, the tape can be played back at a speed ranging from still picture to $\pm 1x$ normal tape speed. When the turning is stopped, a still picture is always produced.

[2] **SHUTTLE** mode

When the outer part dial is rotated in the **SHUTTLE** mode, the tape speed will be changed depending on the position of the **SEARCH/JOG** Dial. The tape speed can be changed from 0 (ie, **STILL** playback) to 9 times the normal tape speed.

The still picture is obtained when the **SEARCH/JOG** Dial is set to the center fix position (click-stop).

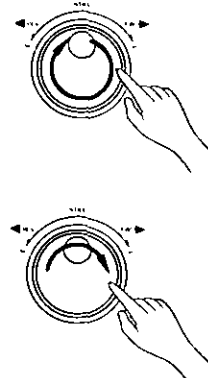

Note

- Set the "DIRECT SEARCH" mode in the ON-SCREEN (initial setting) menu to "ON" to perform the direct search operation. (Refer pages 38 to 41.)

MEMORY STOP Function

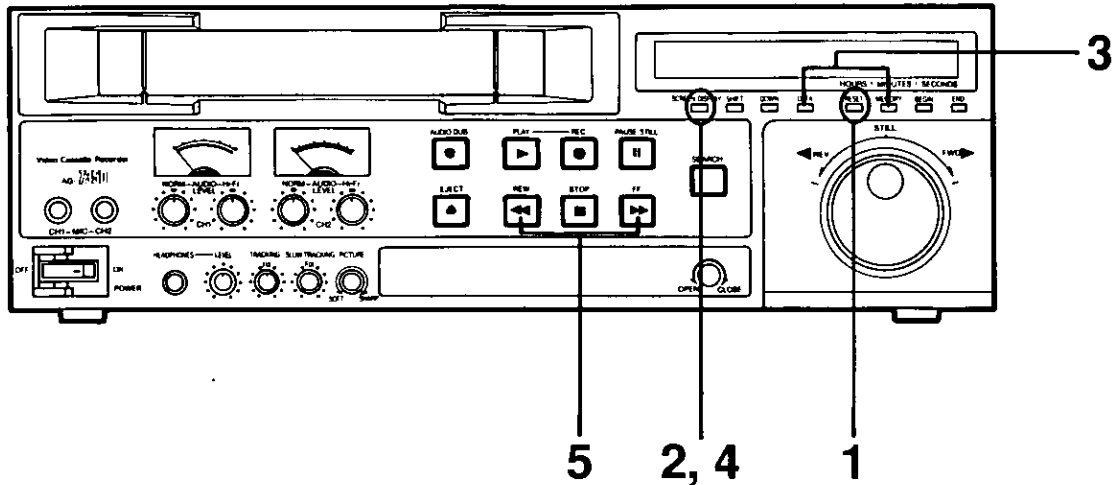

- 1. Press the RESET Button at the point to be automatically stopped.**

- The tape counter will be reset to "0:00:00".

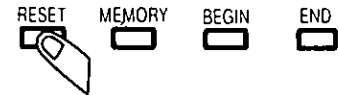

- 2. Press the SCREEN DISPLAY Button.**

- The ON-SCREEN menu will be displayed on the TV monitor.



- 3. Press the DATA or MEMORY Button.**

- Select the "MEMORY STOP" mode.

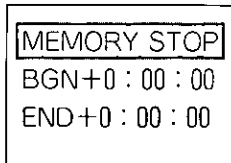

("→000" lamp lights up in the counter.)

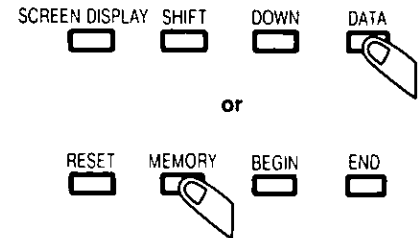

- 4. Press the SCREEN DISPLAY Button.**

- The normal picture will appear.



- 5. Press the FF or REW Button.**

- When the FF or REW Button is pressed, the tape will be wound and then stopped automatically around the tape counter position "0:00:00".

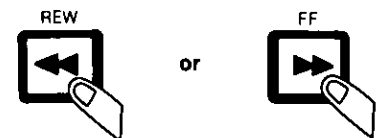

Notes

- MEMORY STOP function is also available by just pressing the MEMORY Button at the position except "0:00:00" after step 1 described above.
- When finished with this function, be sure to select "MEMORY OFF" in step 3 described above. ("→000" lamp goes off in the counter.)

Sensor Recording (AG-7350 only)

Model AG-7150 is not equipped with recording function.

The unit allows to start recording automatically if a video input signal is supplied to the unit from an external source such as a satellite, etc.

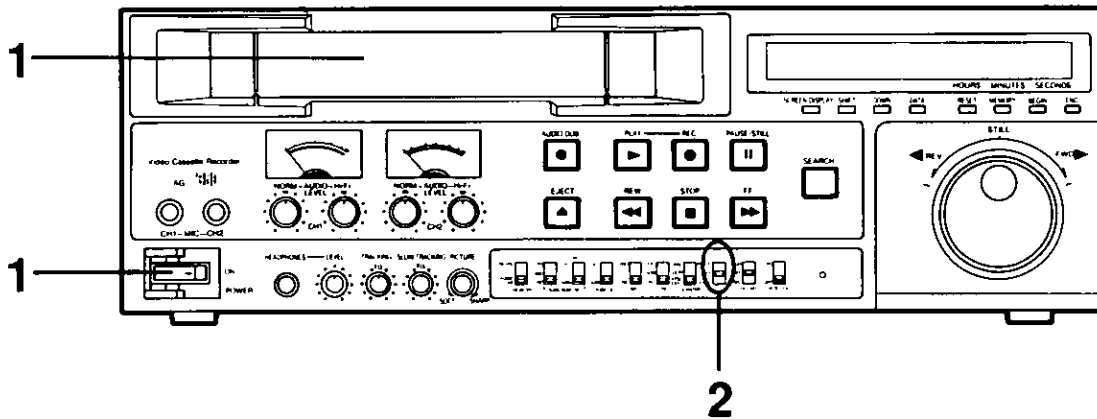

1. Turn on the unit and insert a video cassette.

Make sure that the erasure prevention tab on the video cassette is intact.

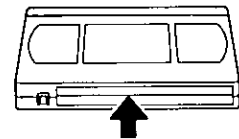

2. Set the SENSOR REC Selector.

In case of "VIDEO" setting:

- The "SENSOR" indicator will appear on the tape counter and the unit will be set to the standby mode. When a video signal is inputted into the VIDEO IN Connector, the unit is turned on and set to the recording mode. When there is no more signal, the unit will go into the stop mode and, after a while, be set to the standby mode again.

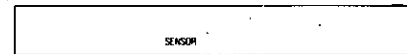

In case of "REMOTE" setting:

- The "SENSOR" indicator will appear on the tape counter and the unit will be set to the standby mode. When a recording start signal is inputted into the SENSOR REMOTE Connector on the rear panel, the unit is turned on and set to the recording mode. When a recording end signal is inputted, the unit will go into the stop mode and, after a while, be set to the standby mode again.
- The tape position where the SENSOR recording started also becomes the beginning position of the REPEAT playback. Similarly, the tape position where the recording ended becomes the end position of the REPEAT playback, and the repeat mode is automatically set to "REPEAT CONTINUE".



Notes

- The "SENSOR" indicator will blink if no video cassette or a video cassette with its erasure prevention tab broken off is inserted in the unit after the SENSOR REC Selector is set "VIDEO" or "REMOTE".
- When the tape reaches its end during the SENSOR recording, the unit is set to the stop mode and turned off.
- Any operation buttons are inoperative after the SENSOR REC Selector is set.

Timer Recording (AG-7350 only)

Model AG-7150 is not equipped with recording function.

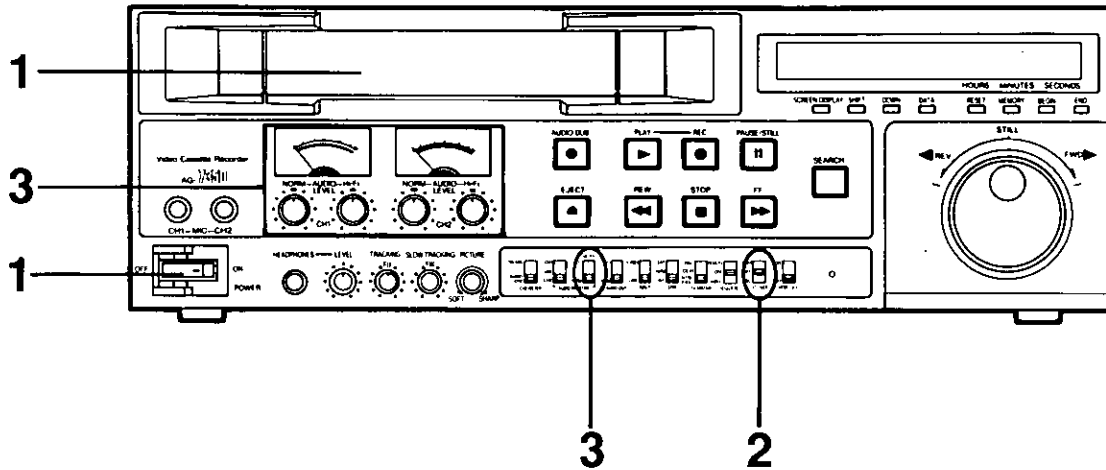

1. Turn on the unit and insert a video cassette.

- Make sure that the erasure prevention tab on the video cassette is intact.

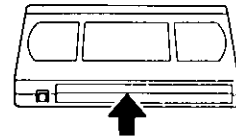

2. Set the EXT TIMER Selector to "REC".

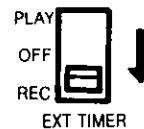

3. Adjust the audio recording level.

(Refer page 14.)

4. Set the timer.

- [1] Turn on the timer.
 - [2] Set the timer to the desired ON and OFF time.
 - It may take about 1 minute to load the tape on the cylinder inside the unit when the preset ON time comes. Therefore, set the preset ON time at least about 1 minute ahead of the actual start time.
 - It is best to set the OFF time so that the unit is turned off about 10 minutes after the tape reaches its end. This will prevent the tape from damage.
If, for example, NV-E180 tape is used for TIMER recording, the recording time should be preset for about 190 minutes.
- Refer to the operating instructions of the timer you are using for details.

Connections

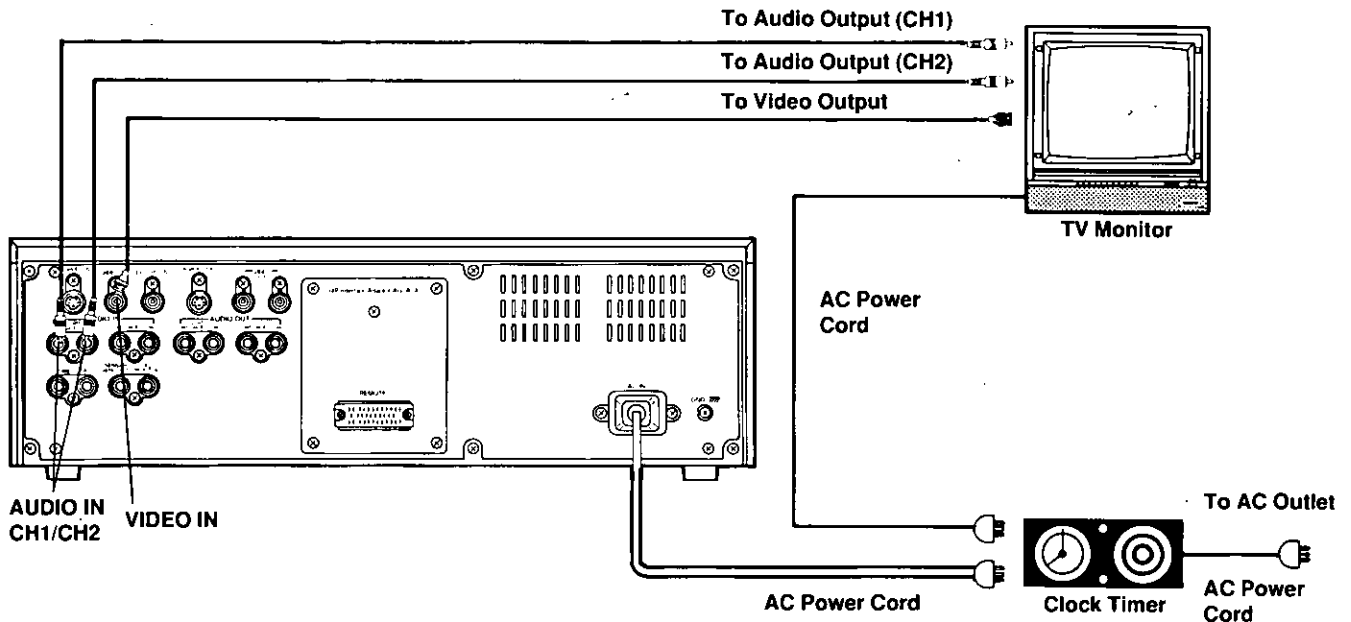

5. When the preset time comes

At the preset time ON time, the unit will be turned on automatically to start TIMER recording. At the preset OFF time, the unit will be turned off, but the tape will remain loaded on the cylinder inside the unit. When the power is resumed, the unit will go into the stop mode and then into the TIMER recording mode.

6. Press the STOP Button to stop TIMER recording halfway.



Notes

- When the tape reaches its end, the unit will go into the mode set in the ON-SCREEN menu (TAPE END MENU).
- If the power is turned off while the tape is moving during TIMER recording, the tape will remain loaded on the cylinder inside the unit. When the power is resumed, the unit will unload the tape from the cylinder. After a while, the unit goes into the stop mode and then the TIMER recording mode.

Camera Recording (AG-7350 only)

Model AG-7150 is not equipped with recording function.

Connections

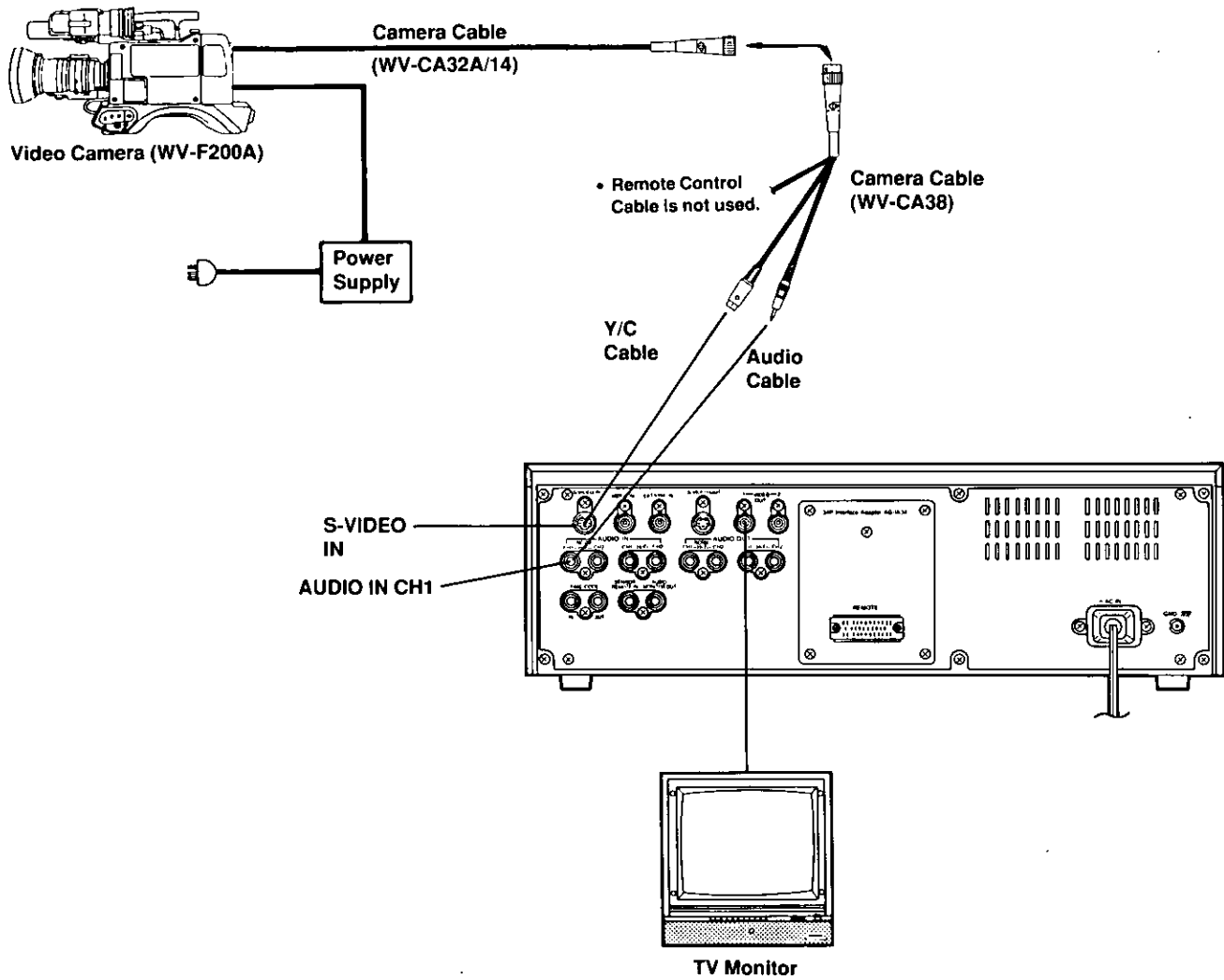

■ Sound Recording with Microphones

Connect the microphones to the MIC (CH1 and CH2) Jacks to record sound with microphones. If a microphone and a audio cable are connected at the same time, only the microphone sound will be recorded.

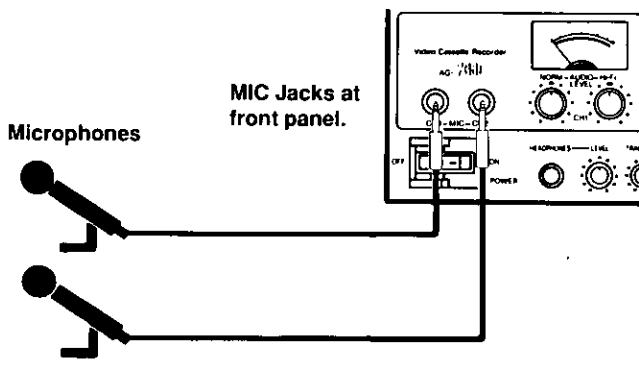

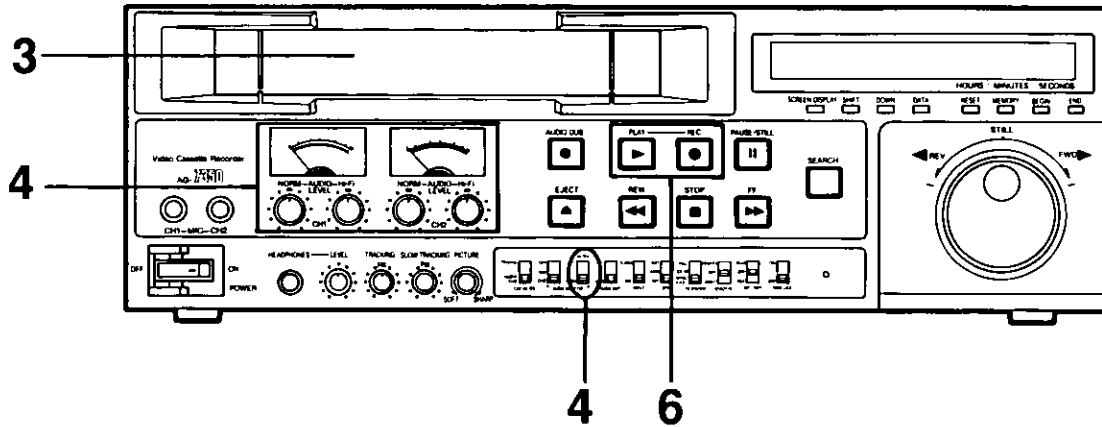

1. Set the selectors.

- INPUT Selector → "LINE" (Refer to page 13.)
- EXT TIMER Selector → "OFF" (Refer to page 12.)
- ON-SCREEN (MEMORY) → "MEMORY OFF" (Refer to pages 36 to 37.)

2. Turn on the TV monitor or the conventional TV set.

3. Insert a video cassette.

- Make sure that the erasure prevention tab on the video cassette is intact.

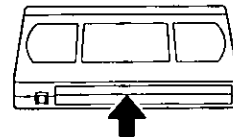

4. Adjust the audio recording level.

(Refer page 14.)

5. Make necessary adjustments on the camera.

- Refer to the operating instructions of the camera you are using for details on how to operate the camera for recording.

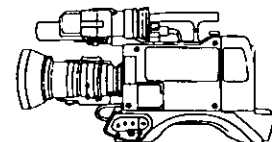

6. Press the REC and PLAY Buttons together.

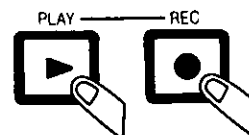

Timer Playback

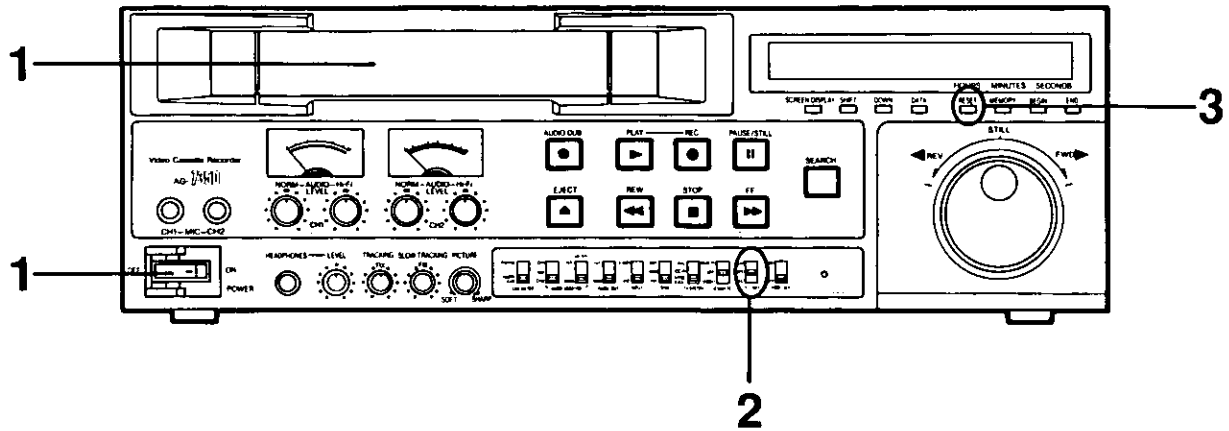

1. Turn on the unit and insert a recorded video cassette.

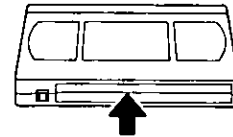

2. Set the EXT TIMER Selector to "PLAY".

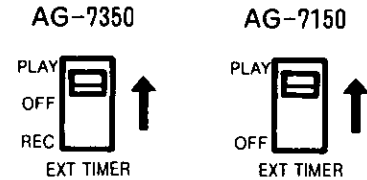

3. Press the RESET Button to reset the tape counter to "0:00:00".

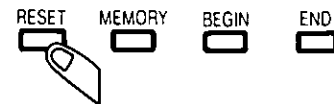

4. Set the timer.

[1] Turn on the timer.

[2] Set the timer to the desired ON and OFF time.

- It is best to set the OFF time so that the unit is turned off about 10 minutes after the tape reaches its end. This will prevent the tape from damage. If, for example, NV-E180 tape is used for TIMER playback, the playback time should be preset for about 190 minutes.

■ Refer to the operating instructions of the timer you are using for details.

Connections

• Connection with video and audio cables

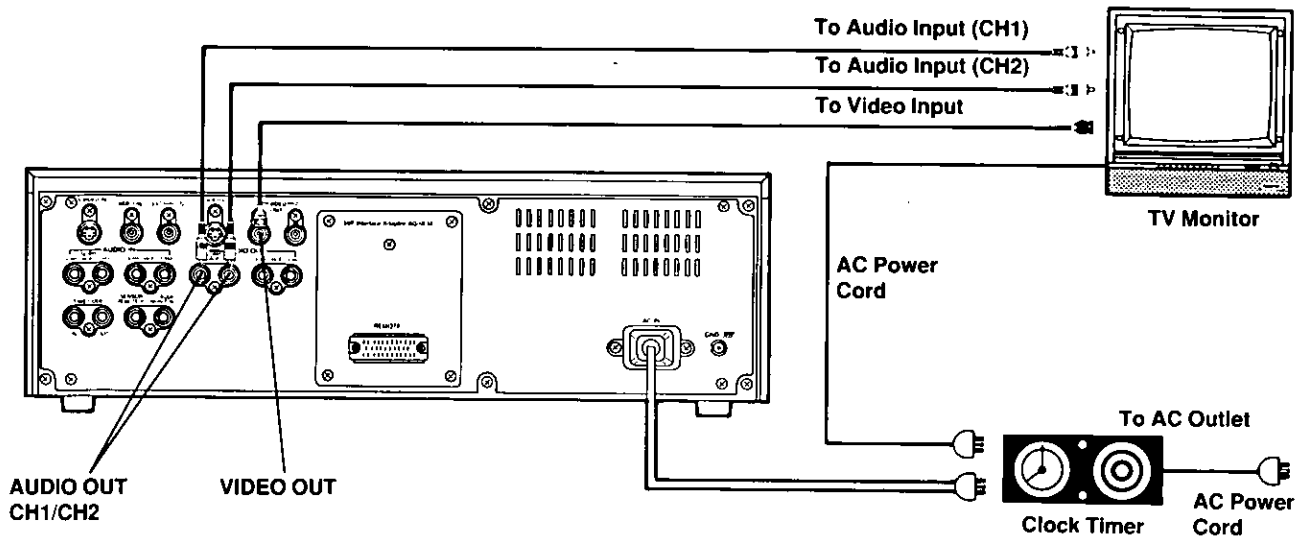

• Connection with S-VIDEO and audio cables

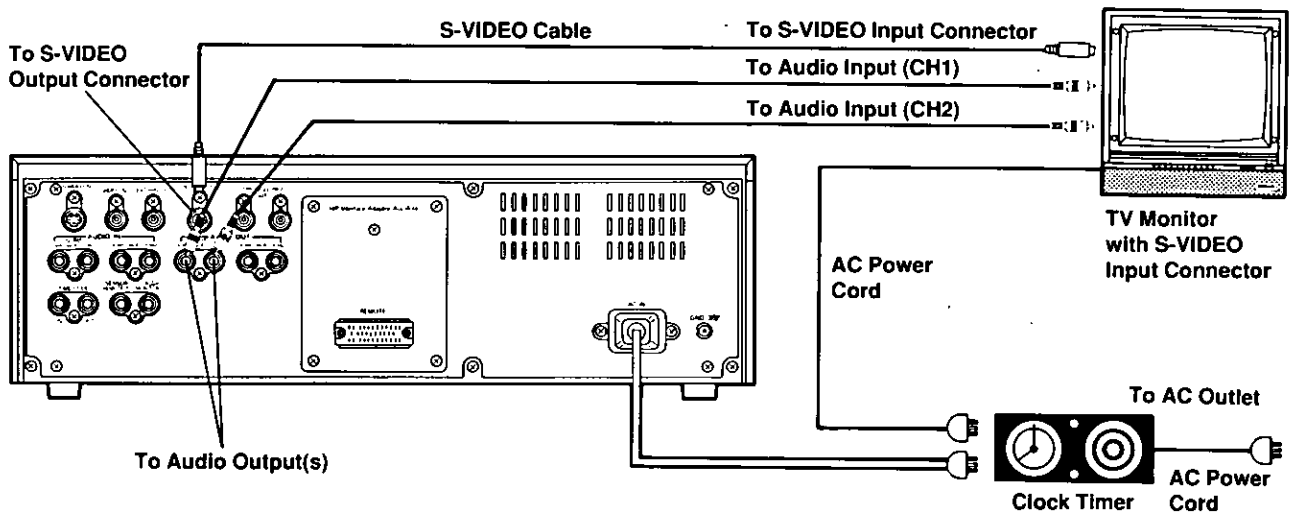

5. When preset time comes

At the preset ON time, the unit will be turned on automatically to start playback. At the preset OFF time, the unit will be turned off, but the tape will remain loaded on the cylinder inside the unit.

- When the repeat function is set, the unit will rewind and then resume the repeat playback.

6. Press the STOP Button to stop TIMER playback halfway.



Notes

- When the tape reaches its end, the unit will go into the mode set in the ON-SCREEN (initial setting) menu. However, during repeat mode, the tape will be automatically rewound.
- If the power is turned off while the tape is moving during TIMER playback, the tape will remain loaded on the cylinder inside the unit. When the power is resumed, the unit will unload the tape from the cylinder. After a while, the unit goes into the stop mode and then the TIMER playback mode.

Repeat Playback

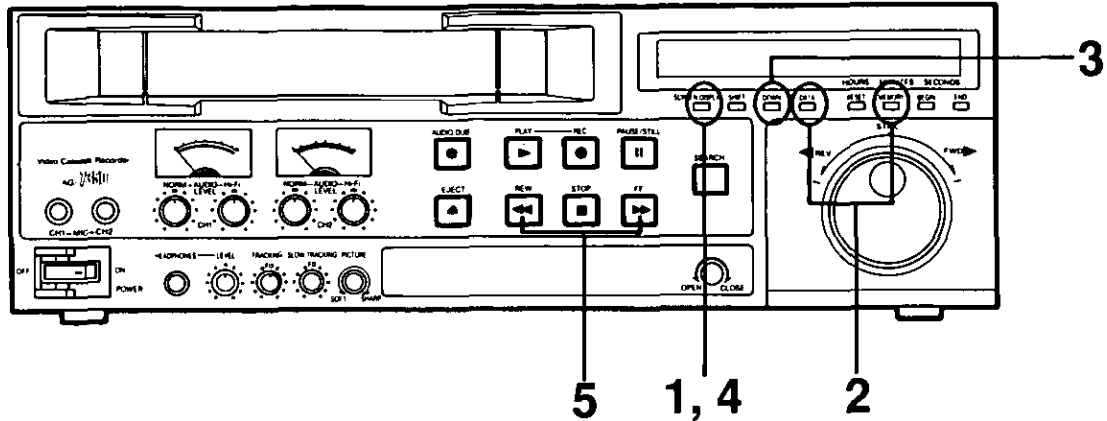

1. Press the SCREEN DISPLAY Button.

- The ON-SCREEN menu will be displayed on the TV monitor.



2. Press the DATA or MEMORY Button.

- Select the repeating mode (one-time or continuous repeated playback mode).
The "↺" or "↻" mark will appear on the tape counter.

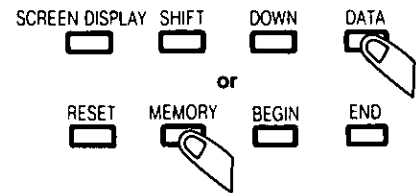

3. Press the DOWN Button.

- Press the SHIFT and DATA Buttons to locate the beginning and end points of section you wish to perform REPEAT playback.

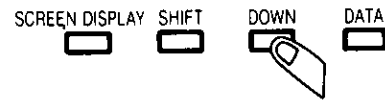

4. Press the SCREEN DISPLAY Button.

- The normal screen will appear.

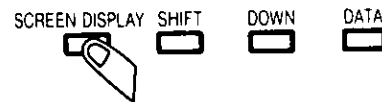

5. Press the FF or REW Button.

- When the tape reaches the beginning BGN points, REPEAT playback will start automatically.

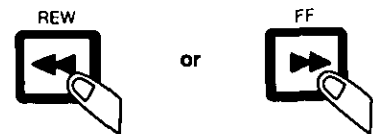

Notes

- When same data is input for BGN and END, repeat playback is performed from the tape beginning to the end.
- When the data for END has exceeded the tape end, repeat playback is performed from the BGN position to the tape end.
- When the data for BGN is smaller than the tape beginning, repeat playback is performed from the tape beginning to the END position.

Dubbing

Model AG-7150 is a player. Therefore, refer to the player side when dubbing.

Dubbing with S-VIDEO Connector

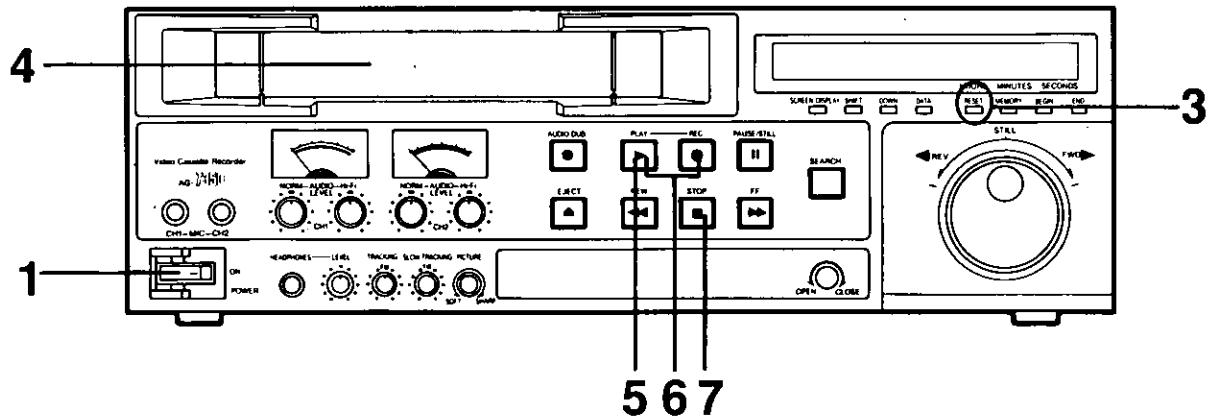

1. Turn on both of the player and recorder VTRs.

2. Set the selectors.

Recorder side

- INPUT Selector → "S-VIDEO" (Refer to page 13.)
- SYNC Selector → "NORM" (Refer to page 13.)
- EXT TIMER Selector → "OFF" (Refer to page 12.)
- ON-SCREEN (MEMORY) → "MEMORY OFF" (Refer to pages 36 to 37.)

Player side

- SYNC Selector → "INT" (Refer to page 13.)
- EXT TIMER Selector → "OFF" (Refer to page 12.)
- ON-SCREEN (MEMORY) → "MEMORY OFF" (Refer to pages 36 to 37.)
- EDIT Selector (ON-SCREEN) → "ON" (Refer to pages 38 to 40.)

3. Press the RESET Button to reset the tape counter to "0:00:00".

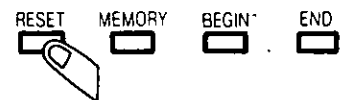

4. Insert video cassettes.

Insert a recorded video cassette in the player and a blank video cassette in the recorder.

- Make sure that the erasure prevention tab on the recorder video cassette is intact.

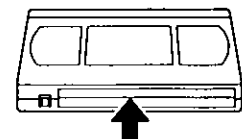

5. Press the PLAY Button on the player.



Connections

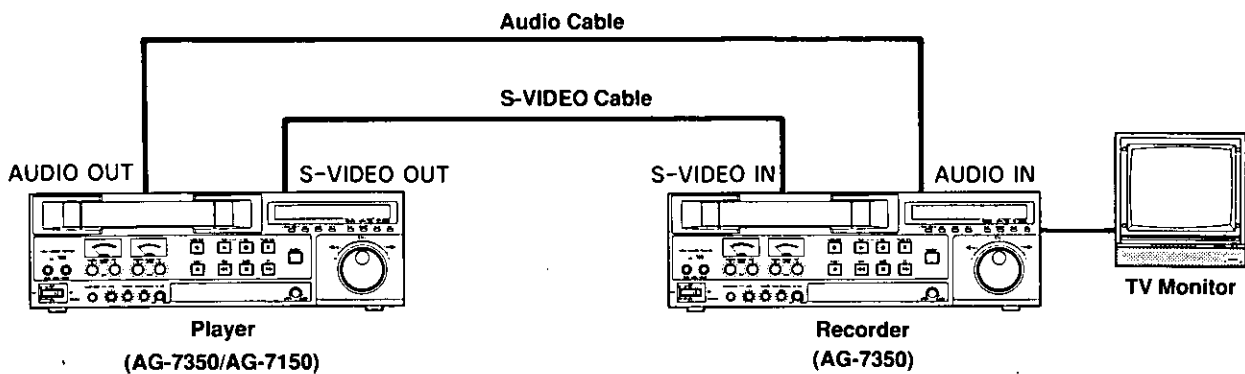

6. Press the **REC** and **PLAY** Buttons together on the recorder at the tape position to start dubbing.

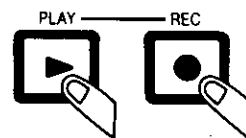

7. Press the **STOP** Button to stop the dubbing.



MEMO

- The **SEARCH/JOG Dial** is convenient to locate the tape segment to be dubbed. Follow the steps instructed below.
 - 1) Press the **SEARCH** Button.
 - 2) Make the search speed constant by using the **SEARCH/JOG Dial**.
 - 3) Press the **PAUSE/STILL** Button to activate the **STILL** mode.
 - 4) If you wish to inch (move slightly) the tape in the forward or reverse direction, press the **PAUSE/STILL** Button again to release the **STILL** mode.
 - 5) Repeat steps 2)~4) until the desired segment is located.

Note

- Be sure to return the "EDIT" ON-SCREEN (initial setting) on the player VTR to "OFF" after dubbing is finished. (Refer to pages 38 to 40.)

Dubbing with Composite (VIDEO IN/OUT) Connector

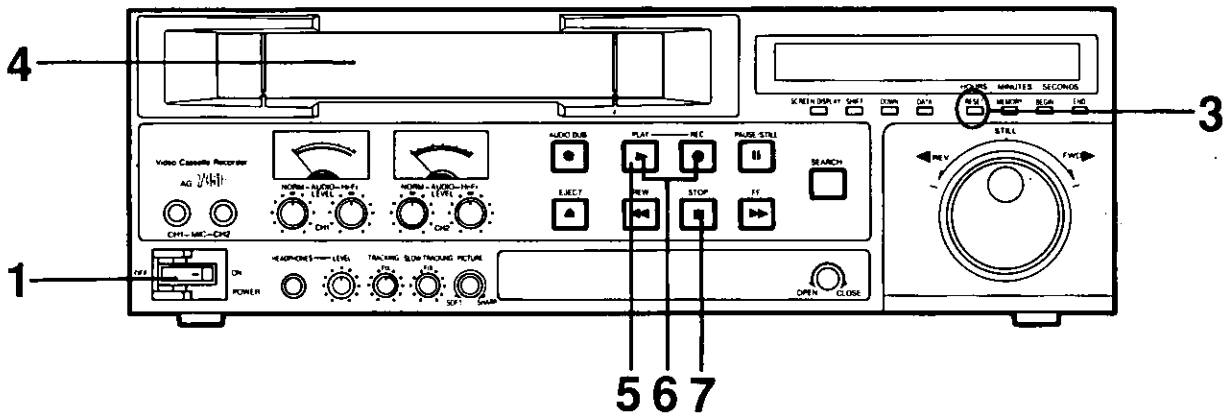

1. Turn on both of the player and recorder.

2. Set the selectors.

Recorder side

- INPUT Selector → "LINE" (Refer to page 13.)
- SYNC Selector → "NORM" (Refer to page 13.)
- EXT TIMER Selector → "OFF" (Refer to page 12.)
- ON-SCREEN (MEMORY) → "MEMORY OFF" (Refer to pages 36 to 37.)

Player side

- SYNC Selector → "INT" (Refer to page 13.)
- EXT TIMER Selector → "OFF" (Refer to page 12.)
- ON-SCREEN (MEMORY) → "MEMORY OFF" (Refer to pages 36 to 37.)
- EDIT (ON-SCREEN) → "ON" (Refer to pages 38 to 40.)

3. Press the RESET Button to reset the tape counter to "0:00:00".

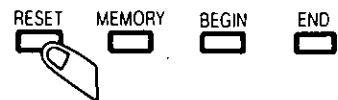

4. Insert video cassettes.

Insert a recorded video cassette in the player and a blank video cassette in the recorder.

- Make sure that the erasure prevention tab on the recorder video cassette is intact.

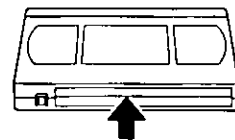

5. Press the PLAY Button on the player.



Connections

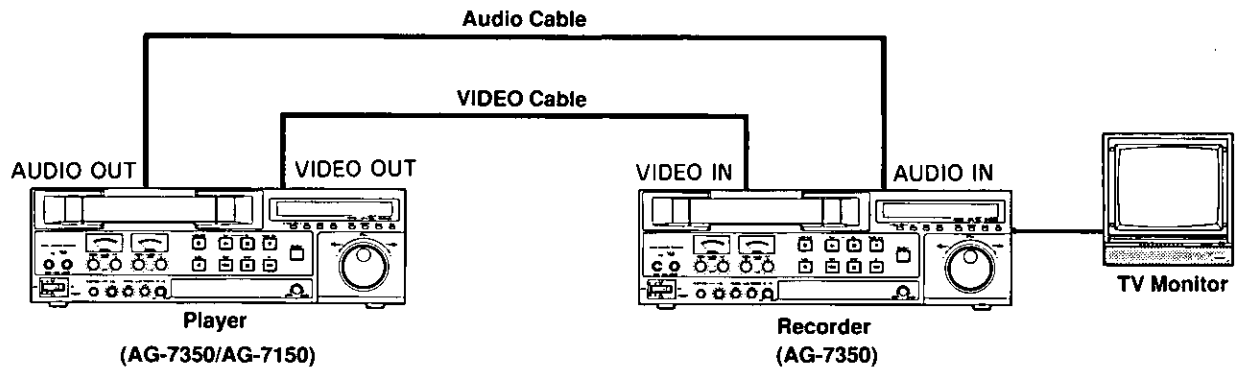

6. Press the **REC** and **PLAY** Buttons together on the recorder at the tape position to start dubbing.

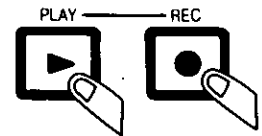

7. Press the **STOP** Button to stop the dubbing.

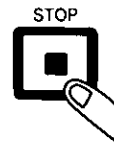

MEMO

- The **SEARCH/JOG Dial** is convenient to locate the tape segment to be dubbed. Follow the steps instructed below.
 - 1) Press the **SEARCH** Button.
 - 2) Make the search speed constant by using the **SEARCH/JOG Dial**.
 - 3) Press the **PAUSE/STILL** Button to activate the **STILL** mode.
 - 4) If you wish to inch (move slightly) the tape in the forward or reverse direction, press the **PAUSE/STILL** Button again to release the **STILL** mode.
 - 5) Repeat steps 2)~4) until the desired segment is located.

Note

- Be sure to return the "EDIT" ON-SCREEN (initial setting) on the player VTR to "OFF" after dubbing is finished. (Refer to pages 38 to 40.)

Time Code

The SMPTE time code signal recorded onto the tape by using a time code generator/reader permits absolute addressing (the identification of storage locations by actual addresses). The time code signal will be recorded on audio CH2 track.

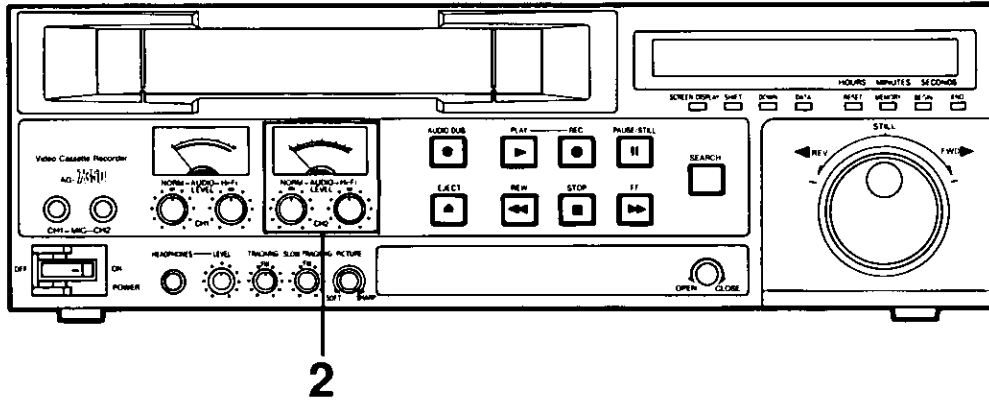

1. Set the selectors.

- CH2 METER Selector → "CH2" (AG-7350 only) (Refer to page 11.)
- AUDIO CH2 (ON-SCREEN) → "TIME CODE" (Refer to pages 38 to 40.)

2. When the time code signal has been entered. (AG-7350 only)

- The AUDIO CH2 LEVEL meter indicates near 0.
- Time code signals are recorded during recording and dubbing (including audio dubbing on channel 2). Refer to the operating instructions of the SMPTE time code generator/reader you are using for details.

Connections

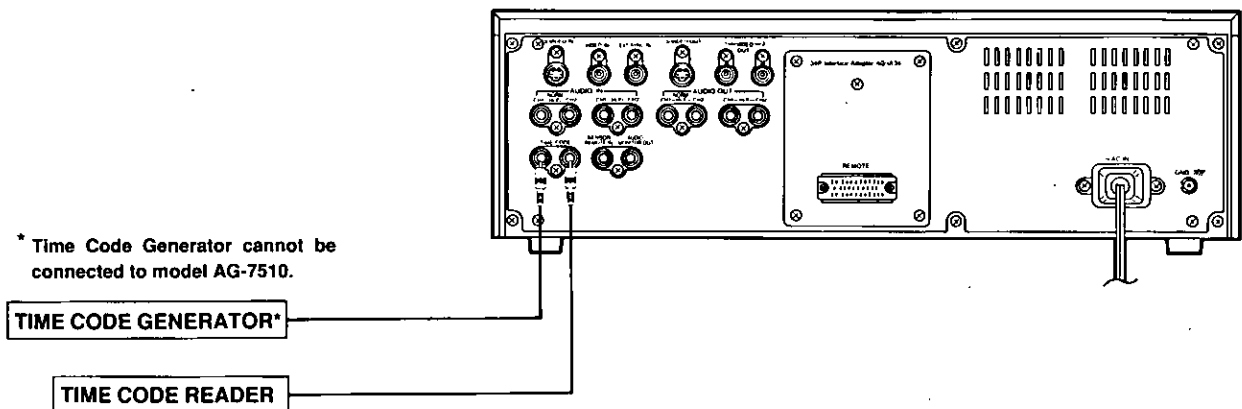

Note

- The unit's tape counter does not count the time code signals, but the control (CTL) signals recorded onto the tape. Connect the time code generator/reader to the unit to read the addresses of the time code signal.

Audio Dubbing (AG-7350 only)

Model AG-7150 is not equipped with this function.

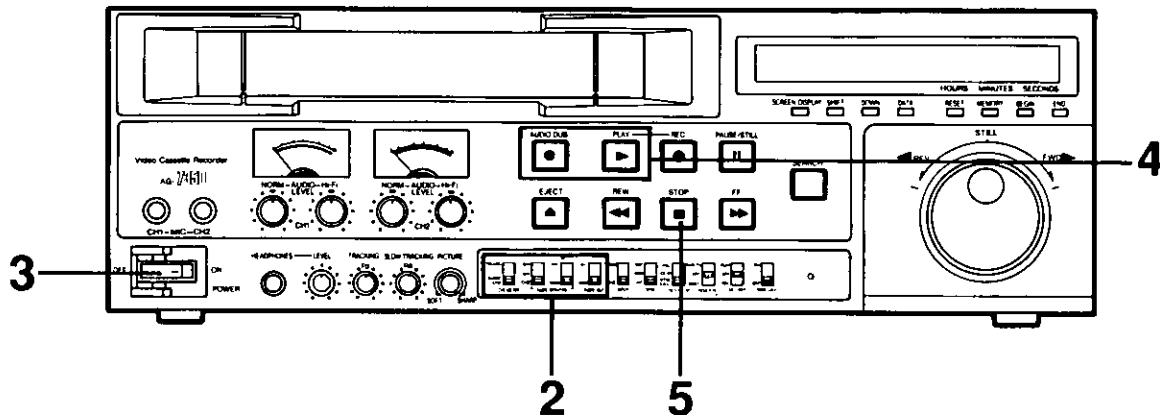

1. Set the selectors.

- INPUT Selector → "LINE" (Refer to page 13.)
- EXT TIMER Selector → "OFF" (Refer to page 12.)
- AUDIO DUB (ON-SCREEN) → "CH1" or "CH2" (Refer to pages 38 to 40.)
- ON-SCREEN (MEMORY) → "MEMORY OFF" (Refer to pages 36 to 37.)

2. Make necessary settings of audio switches.

Refer to page 11.

3. Press the AUDIO DUB and PLAY Buttons together.

- AUDIO DUBBING will start.

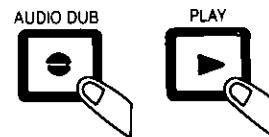

4. Press the STOP Button to stop AUDIO DUBBING.

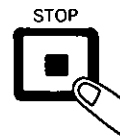

MEMO

- The SEARCH/JOG Dial is convenient to locate the tape segment to be dubbed. Follow the steps instructed below.
 - 1) Press the SEARCH Button.
 - 2) Make the search speed constant by using the SEARCH/JOG Dial.
 - 3) Press the PAUSE/STILL Button to activate the STILL mode.
 - 4) If you wish to inch (move slightly) the tape in the forward or reverse direction, press the PAUSE/STILL Button again to release the STILL mode.
 - 5) Repeat steps 2)~4) until the desired segment is located.

Connections

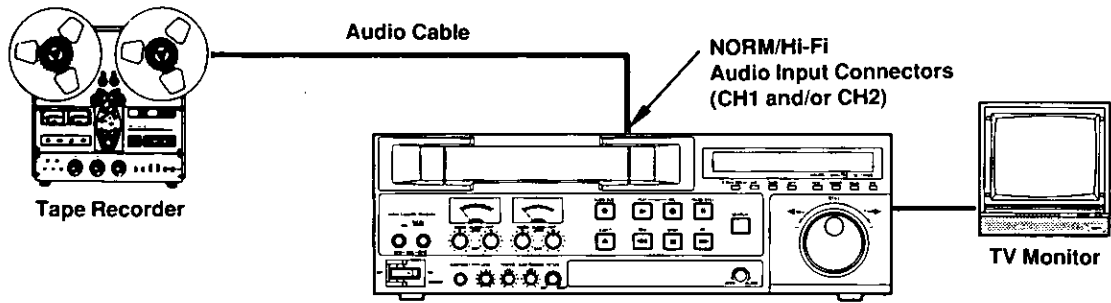

Connection with Microphones

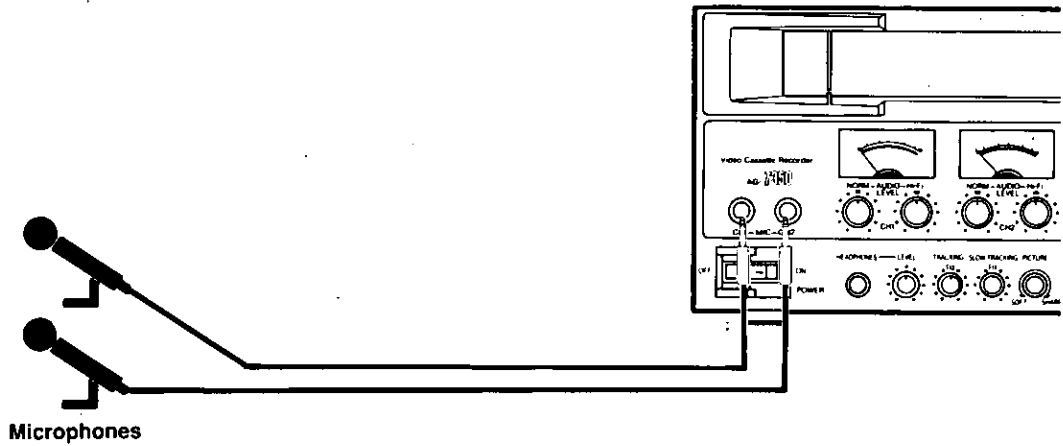

Notes

- If the microphone and audio cables are connected at the same time, only microphone sound will be recorded.
- Hi-Fi effect cannot be obtained by audio dubbing.

ON-SCREEN (Memory Setting)

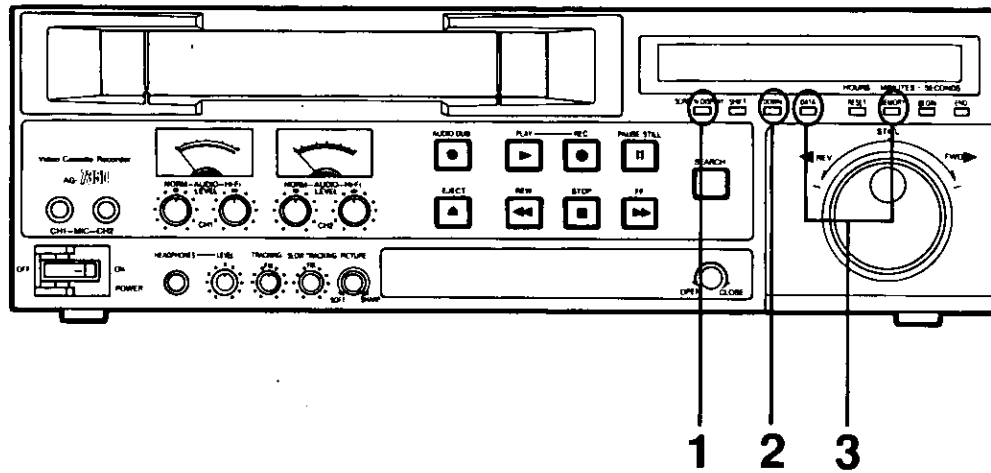

1. Press the SCREEN DISPLAY Button.

- The unit goes into the ON-SCREEN mode and the MEMORY setting menu will display on the screen.



2. Press the DOWN Button.

- The "MEMORY" indication line will flash. Each time the DOWN Button is pressed, the flashing indication will be shifted to "BGN" → "END" → "MEMORY" line.

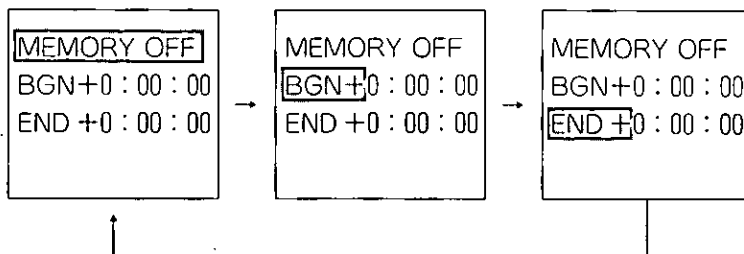

3. Press the DATA or MEMORY Button.

- Select the desired mode while the "MEMORY" indication line is highlighted.

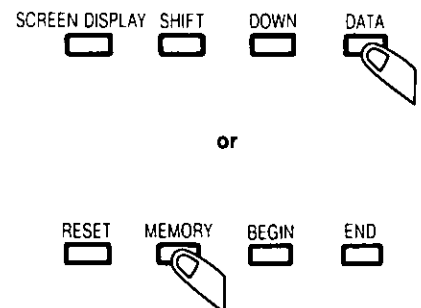
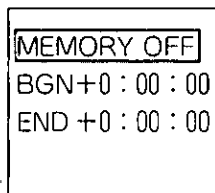

"MEMORY OFF" (No Indication) → "MEMORY STOP" (→000) →
 "REPEAT 1 TIME" (↺) → "REPEAT CONTINUE" (↻)

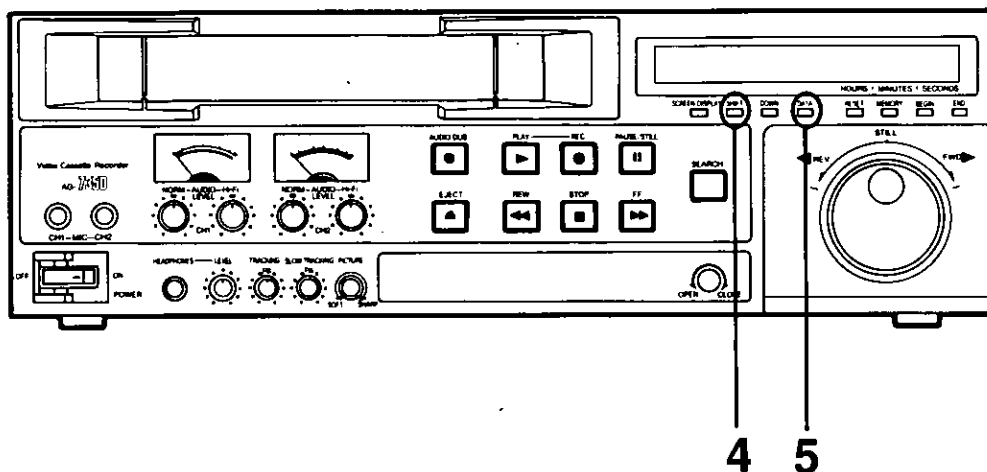

4. Press the SHIFT Button.

The digit to be set will move. The digit is flashing during selection of the desired numeric.

- This step is activated while "BGN" or "END" is highlighted.

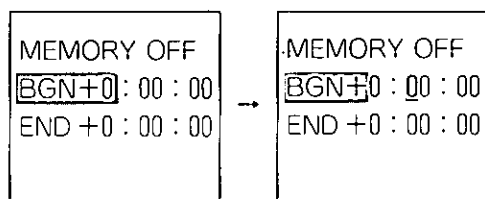

5. Press the DATA Button.

Set the desired numeric and select "+" or "-".

- This step is activated while "BGN" or "END" is highlighted.

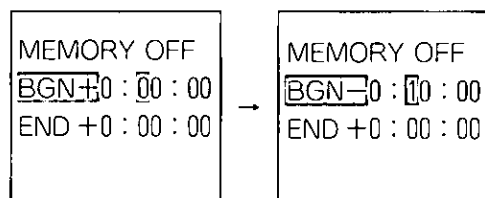

Superimpose display	Description of function
MEMORY OFF	Counter memory is off.
MEMORY STOP	The tape stops at the counter position "0:00:00".
REPEAT 1TIME	Performs one-time REPEAT playback.
REPEAT CONTINUE	Performs continuous REPEAT playback.
BGN	Beginning point of REPEAT playback.
END	End point of REPEAT playback.



ON-SCREEN (Initial Setting)

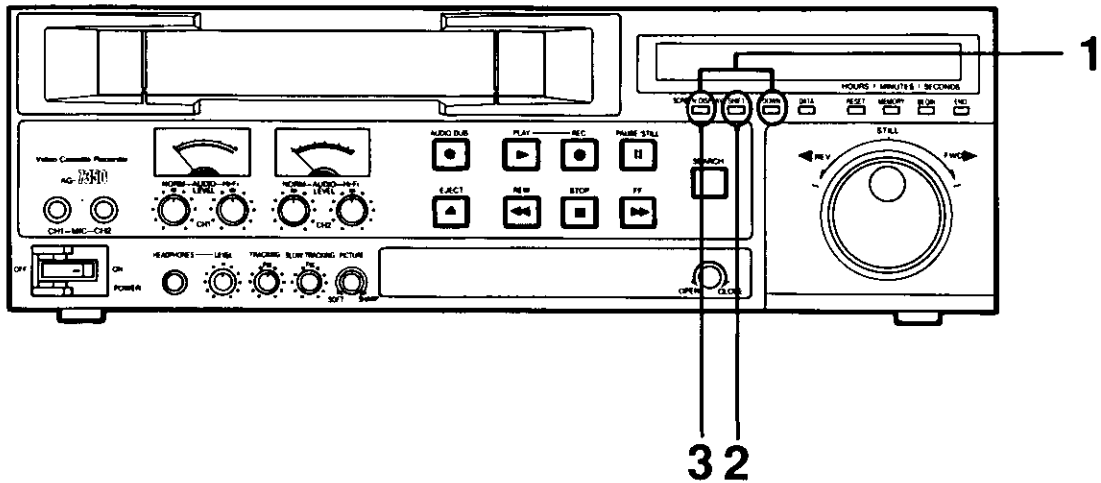

1. Press the DOWN and SCREEN DISPLAY Buttons together.

- The unit goes into the ON-SCREEN mode and the initial setting menu will display on the screen.



2. Press the SHIFT Button.

- Each time the SHIFT Button is pressed, the screen will be changed as follows.

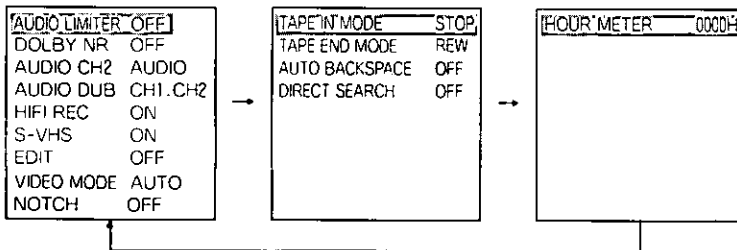

3. Press the SCREEN DISPLAY Button after setting is finished.

- Normal screen will appear.



Note

- If the SCREEN DISPLAY Button is pressed in the initial setting mode, the screen will return to normal.

■ How to set each initial setting item

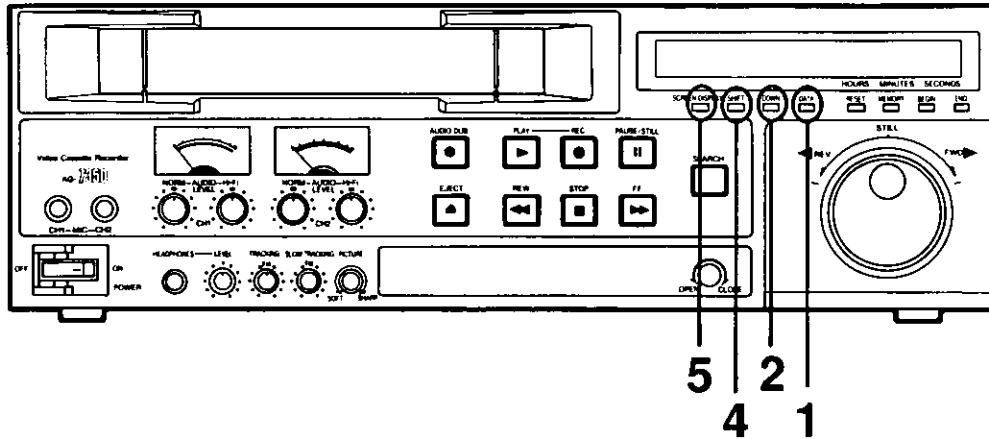

1. Press the DATA Button.

- Select "ON" or "OFF"

AG-7350	
AUDIO LIMITER	OFF
DOLBY NR	OFF
AUDIO CH2	AUDIO
AUDIO DUB	CH1 .CH2
HIFI REC	ON
S-VHS	ON
EDIT	OFF
VIDEO MODE	AUTO
NOTCH	OFF

AG-7150	
DOLBY NR	OFF
AUDIO CH2	AUDIO
EDIT	OFF
VIDEO MODE	AUTO

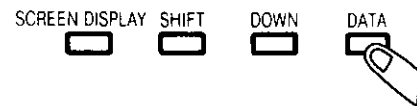

2. Press the DOWN Button.

- The next item will flash.

AG-7350	
AUDIO LIMITER	ON
DOLBY NR	OFF
AUDIO CH2	AUDIO
AUDIO DUB	CH1 .CH2

AG-7150	
DOLBY NR	ON
AUDIO CH2	AUDIO
EDIT	OFF
VIDEO MODE	AUTO

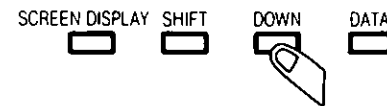

3. Repeat steps 1 and 2 to set each item to the desired mode.

4. Press the SHIFT Button to shift the screen to the next menu.

- Repeat steps 1 and 2 to set each item mode.



5. Press the SCREEN DISPLAY Button after setting is finished to return to the normal screen.



ON-SCREEN (Initial Setting) (CONT'D)

■ Contents of each initial setting item

DATA Button: To select operation mode

DOWN Button: To move to the next item

SHIFT Button: To shift to next menu screen

Superimpose	Description of function	Initial mode									
AUDIO LIMITER (AG-7350 only)	Sets the AUTO LIMITER function ON or OFF. ON: Permits audio recording with less distortion at peak levels with the aid of the automatic volume control circuit. (This function is activated when normal audio recording is performed.) OFF: Permits maximum dynamic range to be recorded, but the level must be set low enough so that peaks do not cause objectionable distortion.	OFF									
DOLBY NR	Sets the DOLBY NR function ON or OFF. ON: Dolby NR system is activated. OFF: Dolby NR system is not activated. ■ DOLBY Noise Reduction System <table border="1" style="margin-left: 20px;"> <tr> <td style="text-align: center;">PLAY REC</td> <td style="text-align: center;">ON</td> <td style="text-align: center;">OFF</td> </tr> <tr> <td style="text-align: center;">ON</td> <td>Normal sound with less noise.</td> <td>Treble is emphasized.</td> </tr> <tr> <td style="text-align: center;">OFF</td> <td>Treble is attenuated.</td> <td>Normal sound</td> </tr> </table> <p>*DOLBY NR system is activated when normal audio is reproduced.</p>	PLAY REC	ON	OFF	ON	Normal sound with less noise.	Treble is emphasized.	OFF	Treble is attenuated.	Normal sound	OFF
PLAY REC	ON	OFF									
ON	Normal sound with less noise.	Treble is emphasized.									
OFF	Treble is attenuated.	Normal sound									
AUDIO CH2	Selects the signal to be recorded or played back on audio channel 2. AUDIO: Audio signal is recorded/played back. TIME CODE: Time code signal is recorded/played back. (Sound track of channel 2 will be muted.)	AUDIO									
AUDIO DUB (AG-7350 only)	Selects the audio track CH1 or CH2 for audio dubbing. CH1: Audio is recorded on channel 1. CH1, CH2: Audio is recorded on both channels 1 and 2. CH2: Audio is recorded on channel 2.	CH1, CH2									
HIFI REC (AG-7350 only)	Sets the Hi-Fi audio recording. ON: Hi-Fi audio is recorded. OFF: Hi-Fi audio is not recorded.	ON									
S-VHS (AG-7350 only)	Sets the recording mode. ON: Distinguishes between the VHS and S-VHS tapes and determines the recording mode. OFF: VHS recording is performed.	ON									
EDIT	Sets the editing mode. ON: To edit or duplicate tapes (dubbing) OFF: For normal operation	OFF									
VIDEO MODE	Selects the colour mode of video input signal. COLOUR: Forcibly colour mode AUTO: Automatically distinguishes between black & white and colour video input signals. Forcibly black & white mode	AUTO									
NOTCH	Selects whether to reduce noise or not. ON: When noise appears during composite input. OFF: When noise do not appear during composite input.	<input type="checkbox"/> ON <input type="checkbox"/>									

ON-SCREEN Function

DATA Button: To select operation mode
DOWN Button: To select to the next item
SHIFT Button: To shift to next menu screen

Superimpose	Description of function	Initial mode
TAPE IN MODE	Selects the VTR function mode after a video cassette is inserted. STOP: The unit goes into the STOP mode. REW: Rewinds the tape automatically. PAUSE: The unit goes into the PAUSE/STILL mode. PLAY: Playback will start automatically.	STOP
TAPE END MODE	Selects the VTR function mode when the tape reaches its end. REW: Rewinds the tape automatically. STOP: The unit goes into the STOP mode. EJECT: The video cassette will be ejected. REW→EJECT: Ejects the video cassette after rewinding the tape automatically.	REW
AUTO BACKSPACE (AG-7350 only)	Sets the Auto Backspace function ON and OFF. ON: The unit rewinds the tape for about 1 second and goes into the PAUSE mode when the REC Button is pressed during the PAUSE/STILL mode or the PAUSE/STILL Button is pressed during recording. Then when the PAUSE/STILL Button is pressed, the unit playbacks the tape for about a second and goes into the recording mode. OFF: For normal PAUSE/STILL operation	OFF
DIRECT SEARCH	Sets the Direct Search function ON and OFF. ON: Allows to operate the SEARCH Dial directly without having to press the SEARCH Button. OFF: For normal SEARCH operation	OFF
HOUR METER	Displays the total of the cylinder driving time.	0000H



Error Displays

The following error messages will be displayed on the tape counter if an abnormality occurs in the unit. In this case, follow instructions described below.

Error display	Problem	Remedy
d	Condensation (dew) forms inside the unit.	Wait until "d" goes out with the power on. (Refer to "In case of dew detection".)
E-2	Elevator Lock trouble	Contact your local dealer.
E-3	Loading Lock trouble	Contact your local dealer.
E-4	Cylinder Lock trouble	Contact your local dealer.
E-5	Reel Lock trouble	Contact your local dealer.
E-6	Tension trouble	Contact your local dealer.

Note

- If the error messages except the indication "d" are displayed, turn OFF the unit immediately and disconnect the power cord from the mains to prevent the unit from serious damage before contacting your authorized service personnel.

In case of dew detection

When condensation (dew, so-called sweating) forms inside the unit, the error message "d" will be displayed on the counter and all the operation buttons are made inoperative. Leave the unit on and let it remain at room temperature until "d" disappears. Depending on the surrounding condition, this may take several hours.

Cause of condensation

Condensation forms if warm air comes in contact with a cold object, for example on a window in a well-heated room in winter. It may form if the unit or the video cassette is exposed to sudden changes in temperature and humidity such as may occur when the unit or the video cassette is taken from a cold to a warm place. For instance:

- In a room where the heater has just been turned on in winter;
- In a room with steam or high humidity;
- If the unit or the cassette is brought from cold surroundings into a well-heated room.

Moisture condensation normally occurs gradually. Therefore, there may be cases in which the "d" indicator does not start flashing until 10 or 15 minutes after moisture has begun to condense. In particular, if the temperature or humidity in the room change, wait about 20 minutes before using the unit.

Troubleshooting

Before requesting service, check the following points once again. If the problem is not solved, contact your local dealer.

Problem	Check points	Page
Operation buttons are inoperative.	<ul style="list-style-type: none"> ■ An error message is displayed on the tape counter. ■ The SENSOR REC Selector is set to "ON". (AG-7350 only) ■ The MODE LOCK Selector is set to "ON". 	42 12, 21 12
Recording cannot be performed. (AG-7350 only)	<ul style="list-style-type: none"> ■ The erasure prevention tab on the cassette's rear is broken off. ■ The INPUT Selector is not set correctly. 	48 13
RECORD or PLAYBACK mode is engaged after the unit is turned on.	<ul style="list-style-type: none"> ■ The EXT TIMER Selector is set to "ON". ■ The SENSOR REC Selector is set to "ON". (AG-7350 only) 	12 12, 21
Playback picture has large amounts of "snow".	<ul style="list-style-type: none"> ■ Video heads are clogged with dirt or abraded. 	49
Noise interference in playback picture.	<ul style="list-style-type: none"> ■ Adjust the TRACKING control. 	16
Playback picture is not in colour.	<ul style="list-style-type: none"> ■ The video input signal was originally black & white. ■ The "VIDEO MODE" in the ON-SCREEN (initial setting) menu is set to "B/W". 	— 40
Counter does not work.	<ul style="list-style-type: none"> ■ CTL (control) signals are not recorded onto the tape. 	—
Playback picture is distorted.	<ul style="list-style-type: none"> ■ Adjust horizontal hold control on the TV monitor. ■ Sudden voltage variations occurred during recording. ■ Tape is old and/or defective. ■ The SYNC Selector is not set correctly. 	— — — 13

Controller (Option)

■ Remote Controller AG-A600

Connection

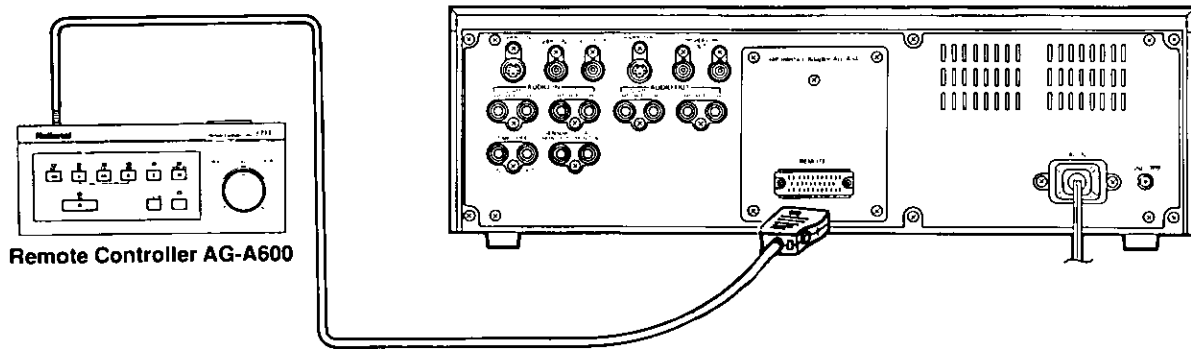

The optional Remote Controller AG-A600 allows RECORD, PLAYBACK, FAST FORWARD, REWIND, PAUSE/STILL, VARIABLE SPEED PLAYBACK (0~9 times normal tape speed) in forward or reverse direction and STOP operations. Operation is possible with the unit's operation buttons even when the AG-A600 is connected to the unit.

Connection with the REMOTE Connector

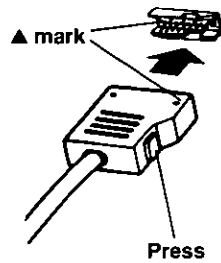

Align the "▲" marks and connect it to the REMOTE Connector while keeping the cable connector button pressed.

Rack Mount Adaptor (Option)

The Rack Mount Adaptor AG-M730-E is used to mount the unit on the IEC standard rack.

Installation of the AG-M730-E

1. Remove the 4 screws

from the side cabinet of the unit.

2. Use the 4 screws supplied

with the AG-M730-E to install it to the unit.

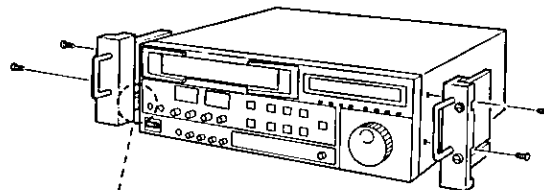

Install it with the notch down

Mounting on the IEC standard rack

1. Remove the 4 rubber legs

from the bottom of the unit.

2. Mount the unit on the rack.

- Be sure to install a ventilation fan (air volume of about 3.3 m²/sec.) on the top of the rack.

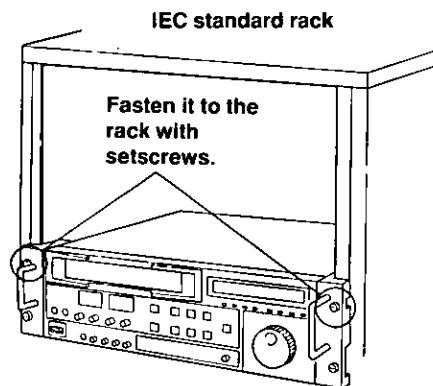

Installation of slide rails

- Use a complete slide rail and bracket unit for 18" length (part No. CC3004-99-0017) or 24" length (part No. CC3004-99-0018) of Chassis Track. (The complete slide rail and bracket unit is not available from Panasonic.)

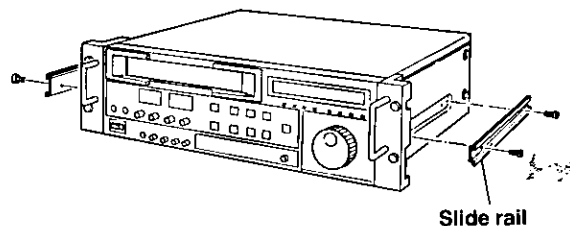

- When using the slide rail, remove the setscrews. The setscrews can be removed by pulling in the direction of the arrow. Keep the removed setscrews, washers and spacers in a proper place.

- For the details, contact your authorized service personnel.

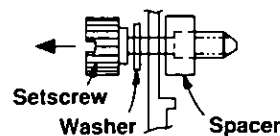

Connector Signals

S-VIDEO IN/OUT Connectors

Pin No.	Description of signal
1	Y GND
2	C GND
3	Y signal
4	C signal

Model AG-7150 is not equipped with S-VIDEO IN Connector.

34P REMOTE Connector

Pin No.	Description of signal
1	REC SWITCH
2	PLAY SWITCH
3	FF SWITCH
4	REW SWITCH
5	STOP SWITCH
6	AUDIO DUB SWITCH
7	PAUSE SWITCH
8	CASSETTE IN
9	AUDIO DUB SWITCH
10	_____
11	_____
12	GND
13	FRAME ADV. SWITCH
14	REVERSE COUNT
15	_____
16	EDIT SWITCH

17	REVERSE
18	CONTROL PULSE OUT
19	REMOTE 19
20	START MARK
21	EJECT SWITCH
22	_____
23	REC HOLD
24	PLAY HOLD
25	FF HOLD
26	REW HOLD
27	_____
28	AUDIO DUB HOLD
29	PAUSE HOLD
30	REMOTE 30
31	AUDIO DUB HOLD
32	_____
33	REMOTE 33
34	+ 12 V

Pin No. 1, 6, 9, 23, 28 and 31 are not used for model AG-7150.

Accessories

Standard Accessories

- 34P Interface Adaptor Mounted on the unit
- Power Cord
- S-VHS cable (4P)

Optional Accessories

- Remote Controller Model No. AG-A600
- 4P S-VIDEO Cable Model No. AG-C71A (5m)
Model No. AG-C70A (3m)
- Rack Mount Adaptor Model No. AG-M730-E

Cassette Tapes

- S-VHS Video Cassettes
- VHS Video Cassettes

Note

Model AG-7350/7150 cannot be connected to an editing controller. Therefore, this unit cannot be used as a source unit in an editing system.

- If the search dial is turned too suddenly when the unit is employed with an editing controller, the unit may not be able to track the dial's setting.
- Use of the AG-7650 is recommended in cases where editing accuracy is required of the source unit.

Notes For Video Cassette

Notes for use

- Unlike audio cassettes, video cassettes may be used on only one side.
- The tape runs from left to right and stops when it reaches the end. When the tape becomes fully wound on the right reel, rewind before using again.
- Do not insert and remove the video cassette in and from the cassette holder repeatedly without getting the tape run to prevent the tape from being loose and damaged.

To prevent accidental erasure

Break off the erasure prevention tab on the cassette. After it has been removed, the tape cannot be used for recording.

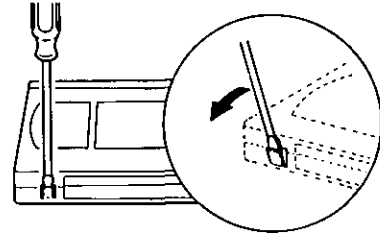

To record again on a cassette with the tab removed, simply cover the hole with adhesive tape.

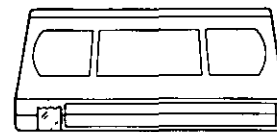

↑ Block the hole with tape.

Notes for handling

Condensation may form on the tape if the video cassette is exposed to sudden changes in temperature and humidity such as may occur when it is taken from a cold to a warm place. In this case, let it remain at room temperature until the condensation evaporates to prevent the tape from damage. Depending on the surrounding condition, this may take about 2 hours.

- Do not touch the tape surface.
- Never subject the cassette to shock or strong vibrations.
- Cassettes are precision-made devices. Do not disassemble them.
- Do not dry condensed tape with a hair dryer, or similar appliance.

Notes for storage

- After use, be sure to fully rewind the tape to the beginning on the left reel.
- Store the cassettes vertically in their cases.
- The cassette should never be stored in the following places:
 - near strong magnetic fields such as generated by a power transformer, electric motor, and magnets, etc.;
 - in extremely damp or dusty places;
 - exposed to direct sunlight or near sources of heat;
 - in a closed automobile.

Regular Inspections

Head cleaning

If the screen should appear as shown below, it means that the video heads are dirty. It is recommended that you clean the heads periodically. Use the optional cleaning tape and special purpose cleaning fluid to clean the heads. Consult with your dealer if the symptoms should persist even after cleaning.



- Repeated head cleaning will shorten the service life of the video heads.
- Nothing can be recorded on the head cleaning tape.
- If you use cleaning fluid, wipe the cleaned heads with a dry cloth before using the unit.

Maintenance

Before proceeding with maintenance, set the power switch to OFF and, remembering to take hold of the power plug, disconnect it from the power outlet.

Use a soft cloth to clean the cabinet. With stubborn stains or dirt, dilute some dish washing liquid, allow a cloth to soak in it, and then wring it out and clean. After having removed the stains or dirt, use a dry cloth to wipe away any moisture.

Do not use paint thinners or benzene.

Storage

- Avoid storing the unit in a location where the temperature is by extremely high or low.
- Under no circumstances should the unit be left outdoors.
- If there are no plans to use the unit for a prolonged period of time, set the power switch to OFF and, remembering to take hold of the power plug itself, disconnect it from the power outlet. This is done to safeguard against accidents and breakdowns.
- Before storing, always remember to remove the cassette tape if one is still inside the unit.



Specifications

General

Power Supply:	120-240V AC, 50-60Hz
Power Consumption:	50W (AG-7350)/44W (AG7150)

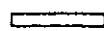
 is the safety information.

Recording System:	2 head-helical scanning, azimuth recording, S-VHS/VHS standards
Tape Speed:	23.39mm/s
Tape Format:	S-VHS tape, VHS tape
Recording Time:	180 minutes (with NV-E180)
Playback Time:	180 minutes (with NV-E180)
FF/REW Time:	About 2 minutes (with NV-E180)
Heads:	Video; 4 rotary heads Audio; 2 rotary heads (Hi-Fi 2ch) Audio/control; 1 stationary head (Normal Audio) Erase; 1 full track erase
Operating Humidity:	35% to 80%
Operating Temperature:	0°C to 40°C (during operation)
Dimensions:	424 mm (W) × 131.5 mm (H) × 424 mm (D)
Weight:	Approx. 11 kg (AG-7350)/Approx. 10.8 kg (AG-7150)

Video

Television Format:	CCIR Standard (625 lines, 50 fields) PAL colour signal EIA (525 lines, 60 fields) 4.43 MHz modified NTSC colour signal
Input/Output: (For "Input", AG-7350 only)	Line (BNC); 1.0Vp-p, 75Ω unbalanced S-Video (4P); Y: 1.0Vp-p, 75Ω unbalanced C: 0.3Vp-p, burst level 75Ω unbalanced
Composite Sync Input:	BNC; 4.0Vp-p, negative pulse, 75Ω unbalanced
Horizontal Resolution:	VHS; B/W 300 lines/colour 240 lines S-VHS; Over 400 lines (B/W, colour)
S/N Ratio:	VHS; 45dB (B/W) 45dB (colour)

Audio

Input: (AG-7350 only)	Line (phono); -8dBv, 47kΩ unbalanced Mic (1/4"); -60dBv, 4.7kΩ unbalanced Time code (phono); 1.0Vp-p, 10kΩ unbalanced
Output:	Line (phono); -8dBv, 600Ω unbalanced Monitor (phono); 0dBv, 600Ω unbalanced Headphones (1/4"); -60dBv~-20dBv, 8Ω unbalanced Time code (phono); 2.4Vp-p, low impedance unbalanced
Track number:	4 tracks (Normal: 2, Hi-Fi: 2)
S/N Ratio:	48dB (Normal Audio: Dolby NR ON)
Hi-Fi Dynamic Range:	90dB
Frequency Response:	50Hz to 12kHz (Normal Audio) 20Hz to 20kHz (Hi-Fi sound)

*1Vrms=0dBv

Weight and dimensions shown are approximate.
Specifications are subject to change without notice.

MEMO

Matsushita Electric Industrial Co., Ltd.

Central P.O. Box 288, Osaka 530-91, Japan

© Matsushita Electric Industrial Co. Ltd.
All rights reserved. Unauthorized
copying and distribution is a violation of law.

Printed in Japan
VQT4386

S0691S-200 (A)

B