

XA2125 JENSEN®

Amplifier Installation and Operation

XA275

XA250

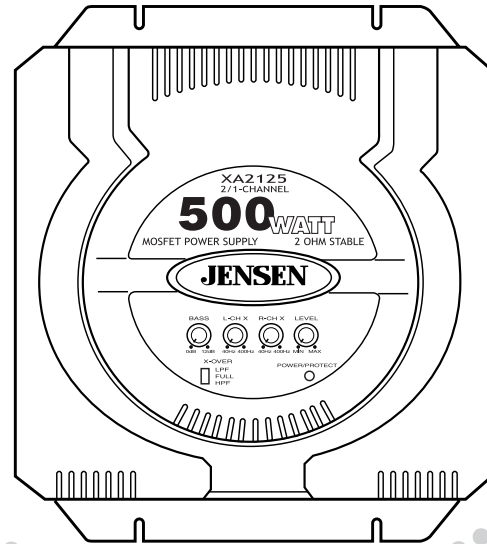

Introduction

Thank you for purchasing a Jensen amplifier. The XA series amplifiers offer extreme value and performance. Proper installation is essential for optimal performance and long-term reliability. Please read through this manual first to familiarize yourself with your amplifier and its functions.

Warranty Service

If your Jensen amplifier should ever require service, you will need to have the original dated receipt. If you ever need to return the unit for any reason, always include the receipt with the product.

Installation Assistance

1.800.323.0221

365 / 24 / 7 @ www.jensen.com



Contents

Features 3

Installation 3

Before You Begin 3

 Disconnect Battery 3

 Supplies and Tools Needed 3

 Location and Mounting 4

 Routing Wires 4

Wiring 5

Power 5

 Power Terminal (+12V) 5

 Ground Terminal (GND) 5

 Remote Terminal (REM) 5

 Fuses 5

**Inputs, RCA Output,
 Remote Level Control 6**

 Input Wiring 6

 Connecting Other Amps 6

 Remote Level Control (XA2125) 7

Speaker Wiring Options 7

Indicators and Controls 9

 Crossover (X-OVER) 9

 Power/Protect Light 9

 Level 9

 Bass 9

Testing 10

 Reconnect Battery 10

 Test Power Wiring 10

 Test Speaker Connections 10

Troubleshooting 11

Specifications 12

Warranty 13



Features

XA Series 2-channel amplifiers include:

- Easy access top mounted controls
- Continuously variable high pass/low pass crossover
- 40Hz – 400Hz crossover frequency range
- Crossover mode selector switch
- Continuously variable bass boost, centered at 45Hz
- Input level control
- Remote level control (XA2125)
- Traditional input circuitry – low and high level inputs
- Pre-amp output for installation flexibility
- Dual status LED diagnostic indicator
- Thermal, short circuit and low impedance protection circuitry
- PWM MOSFET power supply
- Discrete amplifier design with complementary high current Bi-polar output stage

Installation

Before You Begin

Before you begin, you will need tools, supplies and adapters. It is best to make sure you have everything you need before you start.

Disconnect Battery

Before you begin, always disconnect the battery negative terminal.

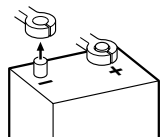

Supplies and Tools Needed

Supplies

- Black electrical tape
- Amplifier Installation Kit

Tools

- Cordless drill with assortment of bits
- Flat and Phillips screwdrivers
- Wire cutters/strippers
- Crimping tool
- 12-volt test light or digital multimeter
- Wire brush, sandpaper or scraping tool (ground connection to vehicle should be a clean, unpainted metal surface)

Location and Mounting

The XA amplifier's compact design allows greater flexibility in mounting. It can be mounted under a seat or in the trunk.

When selecting a location, remember that amplifiers generate heat. Select a location where air can circulate around the amplifier. Do not cover the amplifier with carpets or enclose it behind interior trim panels. Do not mount the amplifier in an inverted or upside down configuration. Every installation will be a bit different based upon vehicle design. Check all locations and placements carefully before making any cuts or connections.

Important

Allow air circulation around the amplifier.

Routing Wires

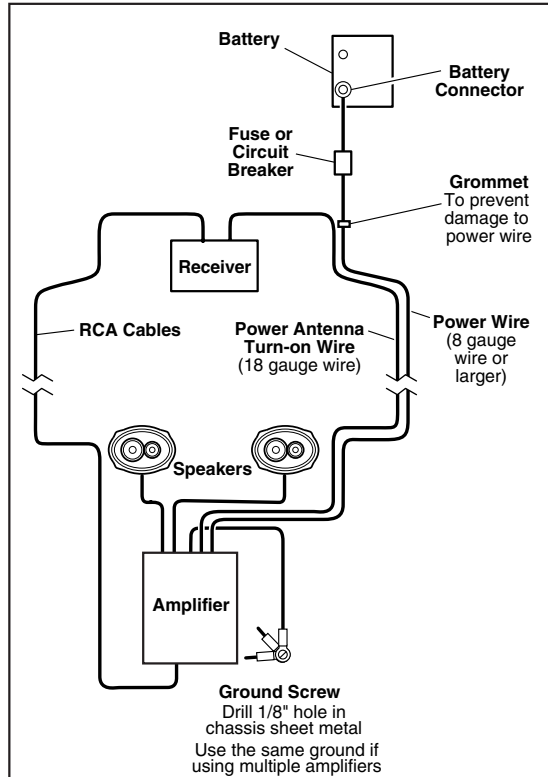

Important

If wiring connections are made wrong, the unit will not operate properly and it could be damaged. Follow the installation instructions carefully, or have the installation handled by an experienced technician.

Wiring

Power

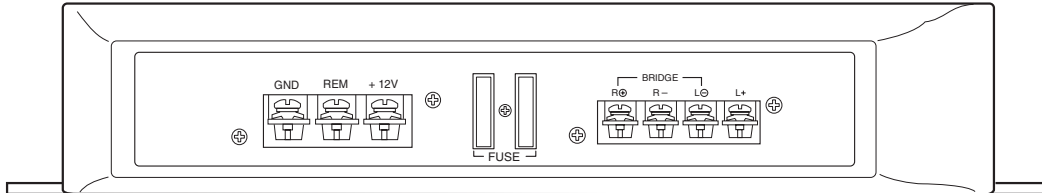

Power Terminal (+12V)

Connect directly to the vehicle battery+ terminal with 8 gauge wire (minimum).

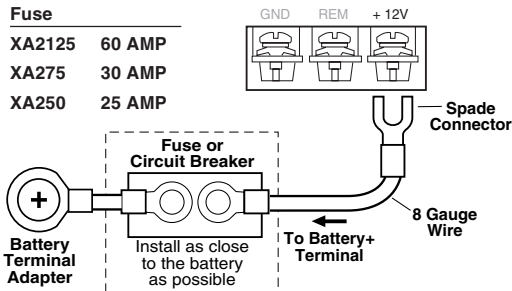

Remote Terminal (REM)

Connect the power antenna/amplifier turn-on lead from the receiver to the AMPLIFIER REMOTE terminal.

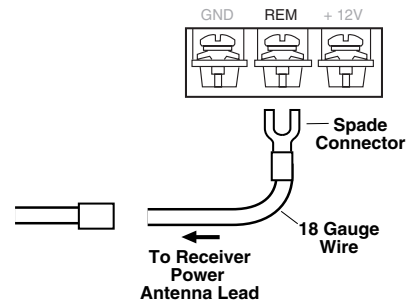

Ground Terminal (GND)

Connect to a good chassis ground. The ground connection should be to clean, unpainted metal to provide a good electrical connection.

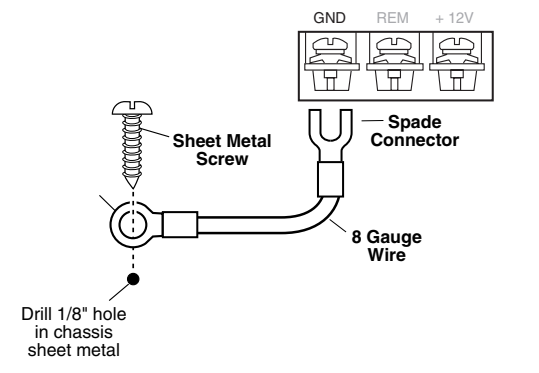

Fuses

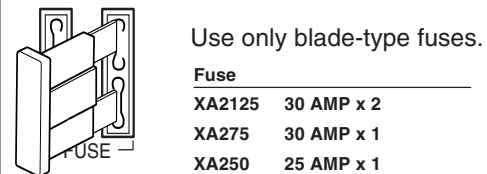

Inputs, RCA Output, Remote Level Control

XA2125

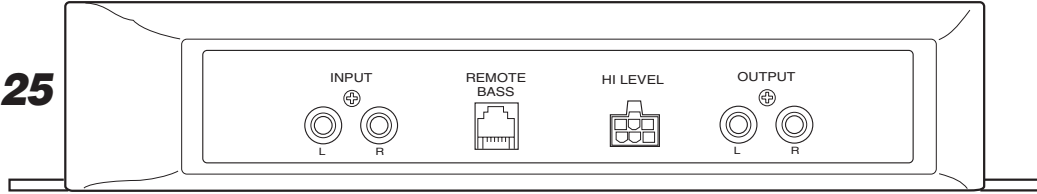

XA275

XA250

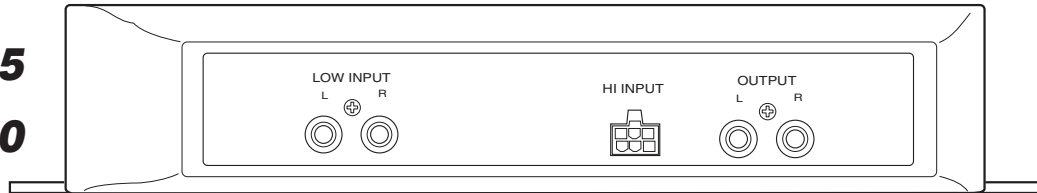

Input Wiring

Low Level Input (RCA Input)

Low level (RCA) input is preferred for best performance. Most trunk/hatchback installations will require a 15-20 foot RCA cable. While pick-up trucks and under-seat mounting will require a 6-10 foot RCA cable. Connect an RCA cable from your receiver to the RCA input on your amplifier.

High Level Input

High level input should be used when an RCA output is not available from the receiver. Connect the speaker outputs from the receiver to the high level input connector.



Important

Only connect the low (RCA) or high level input. Do not use both at the same time.

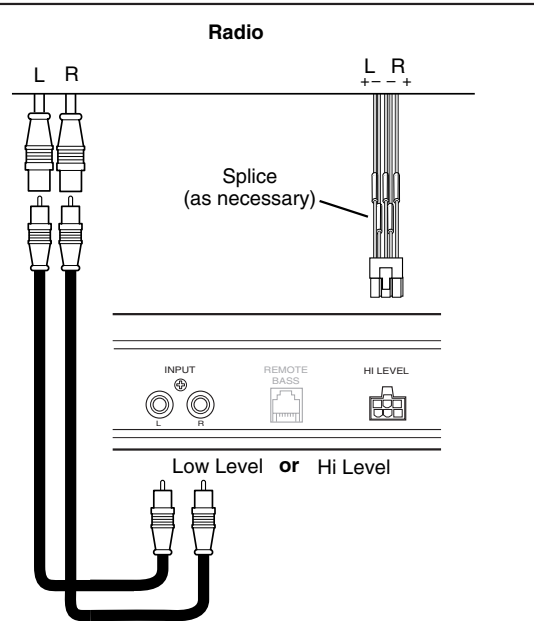

Connecting other Amps

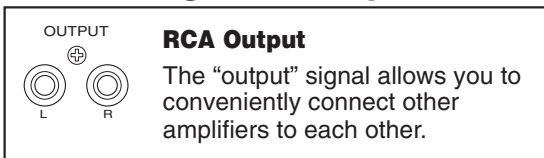

XA2125, XA275, XA250



Remote Level Control (XA2125)

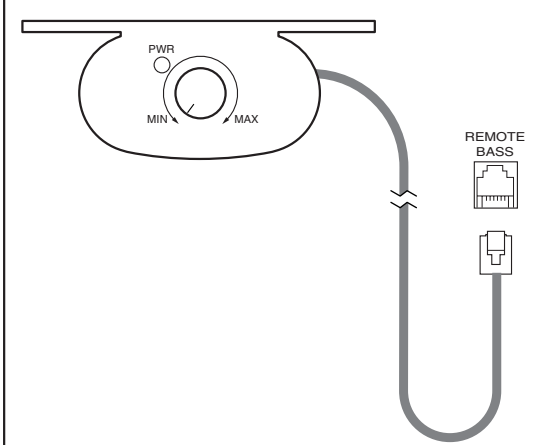

Remote level control allows the input level to be adjusted from an alternate location. It can be mounted under-dash or in-dash. When the amplifier is used to drive subwoofers, and the low pass crossover is activated, the remote level control can be used as a "remote bass level control". This enables you to control the bass level, independent from the rest of the system. This is convenient for system tuning and/or when playing many different types of music.

Speaker Wiring Options

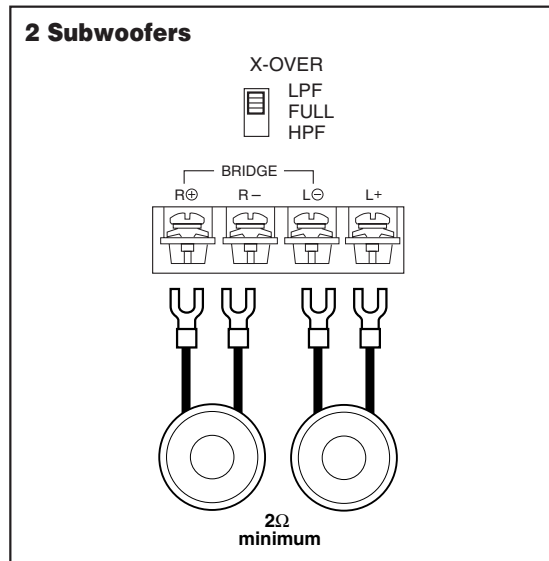
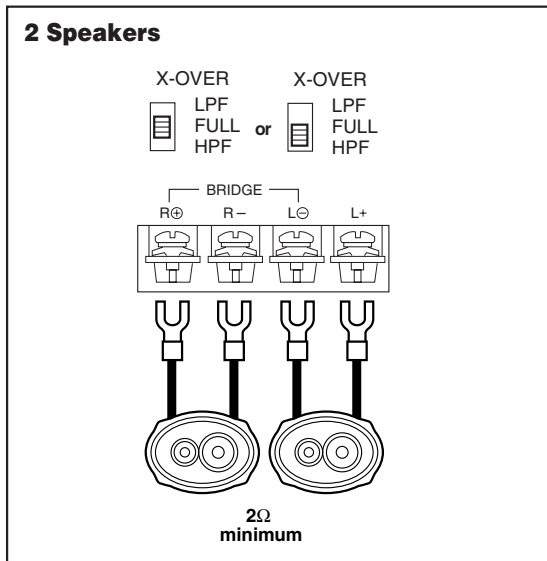

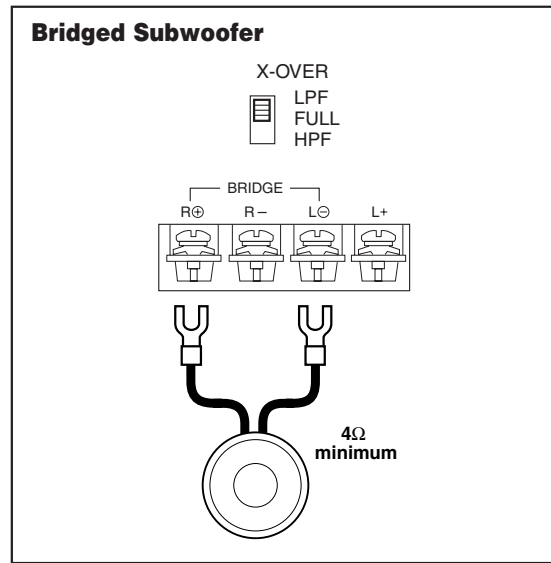
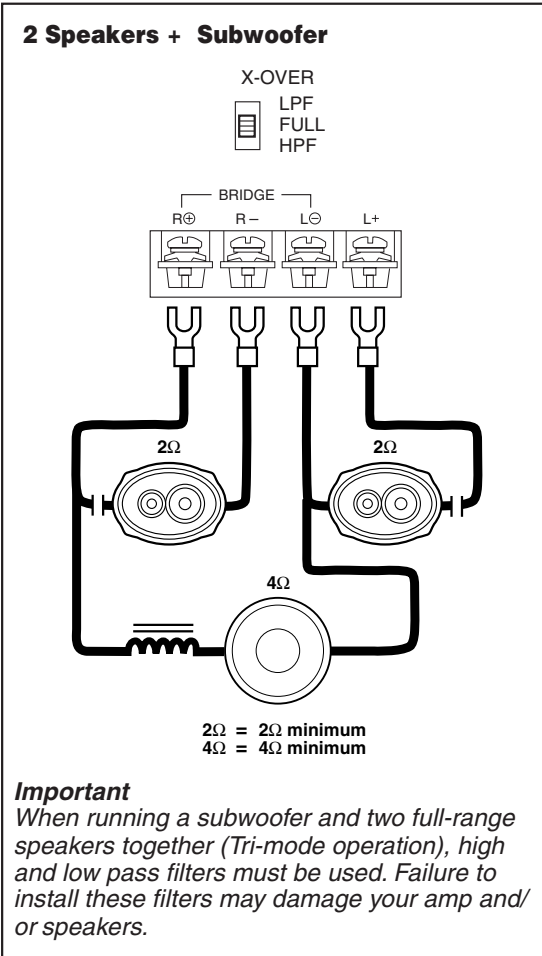

Freq. Hz	Speaker Impedance					
	2 OHMS		4 OHMS		8 OHMS	
	L	C	L	C	L	C
80	4.1mH	1000μF	8.2mH	500μF	15mH	250μF
100	3.1mH	800μF	6.2mH	400μF	12mH	200μF
130	2.4mH	600μF	4.7mH	300μF	10mH	150μF
200	1.6mH	400μF	3.3mH	200μF	6.8mH	100μF
250	1.2mH	300μF	2.4mH	150μF	4.7mH	75μF
400	.8mH	200μF	1.6mH	100μF	3.3mH	50μF
600	.5mH	136μF	1.0mH	68μF	2.0mH	33μF
800	.41mH	100μF	.82mH	50μF	1.6mH	26μF
1000	.31mH	78μF	.62mH	39μF	1.2mH	20μF
1200	.25mH	66μF	.51mH	33μF	1.0mH	16μF
1800	.16mH	44μF	.33mH	22μF	.68mH	10μF
4000	.08mH	20μF	.16mH	10μF	.33mH	5μF

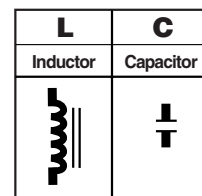

Indicators and Controls

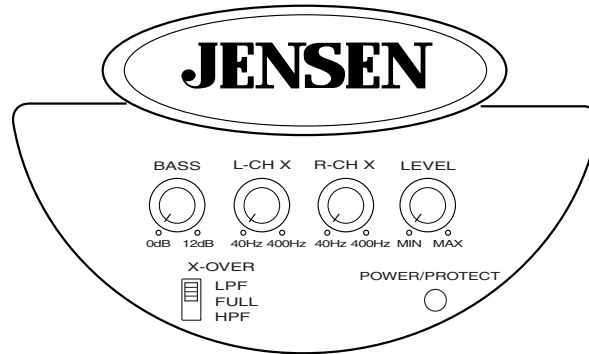

Crossover (X-OVER)

Adjust the crossover to accommodate your chosen installation method.



- **LPF**—(low pass filter) Select this filter when the amplifier will be driving woofers or subwoofers.
- **FULL**—Crossover is not active, amplifier is in "full range" mode.
- **HPF**—(high pass filter) Select this filter when the amplifier will be driving full range/separate speakers, and you want to limit the "bass" going to these speakers.

Tri-mode/Three channel operation

An amplifier is usually configured for tri-mode operation when you want to use one amplifier to drive a pair of front speakers and subwoofer(s). In other words, when you want to drive a complete system with one amp. Your Jensen amplifier is capable of tri-mode operation.

Important

Tri-mode operation requires using "passive crossovers". These crossovers are available at your local retailer or install shop. Failure to install these filters may damage your amplifier and/or your speakers.

Power / Protect Light

POWER/PROTECT  A dual status LED indicator illuminates red or green to indicate the status of the amplifier.

Green – Power applied, ON
Red – Protection circuit activated, STANDBY

Level

LEVEL  The input level control matches the output of your radio to the input of the amplifier. After the installation is complete, make sure the input level control on the amp is turned down all the way (counterclockwise or all the way to the left). Play a tape or CD (make sure bass and treble settings or EQ are flat too) and turn the volume up slowly until you just start to hear distortion. Now back the volume down just a bit. On the amp, slowly turn up the input level control (clockwise or to the right) until you just start to hear distortion and back it down a bit. Now your radio and amplifier levels are matched.

Bass

BASS  **BASS** increases the volume of the bass at 45Hz by up to 6–12 db. **Use very carefully!**

XA2125 **XA275**
 XA250

Testing

Before you finish the installation, you should do the following tests to make sure the wiring is correct and everything is operating properly.

Reconnect Battery

When wiring is complete, reconnect the battery negative terminal.

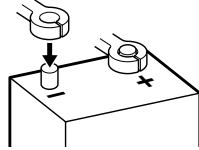

Test Speaker Connections

These tests make sure the speakers are connected right. If speakers don't play at all, one (or both) speaker wires may be disconnected. If the wrong speaker plays (you hear left speaker when you expect right speaker) make sure you connected the wires correctly.

Test Power Wiring

1. Turn on the receiver but do not turn up the volume. The amplifier power light should come on. If not, check the REM and +12V wires.
2. Turn up the receiver volume slightly. All speakers should operate. If not, check wiring connections at amplifier and speakers.



Troubleshooting

Problem	Possible Cause	Corrective Action
Amplifier does not operate (power LED not on) when vehicle and radio are on	No power to +12V terminal	Repair wire or connections.
	No power to remote wire with radio on	Check connections to radio with test light.
	Fuse blown	Check fuse.
Radio volume needs to be turned up too high for amp to work	Input level control adjusted too low	Adjust input level control.
Radio volume is too sensitive	Input level control adjusted too high	Adjust input level control to lower setting.
Sound from only one speaker	Defective speaker	Replace speaker.
	Poor connections to speaker (wire)	Check connections.
	RCA input cable defective	Replace cable.
	Input level control adjusted too high	Adjust input level control.
Sound distorted	Speaker wires shorting together	Separate speaker wires and insulate.
Blows fuses	Power wires hooked up incorrectly	Check power wire connections.
	Speakers blown or defective	Check speakers.
Engine noise (Ignition noise/static or Alternator whine)	Improper ground connections Ground loop(s)	Reroute RCA away from main power wires.
		Reroute RCA cable.
		Make sure amp is grounded to a clean, solid part of the chassis/frame.
Protect light comes on/ amplifier shuts down	Amp is in thermal protection	Let amp cool down before attempting to turn back on (some installations may require a fan to keep the amp cool, especially if you are driving subwoofers with the amp).
	Faulty speaker connection and/or crossover	Check speakers and/or crossovers for loose or bad connections.
	Low battery voltage	Make sure you are getting between 10.8-15.6 volts to the amplifier with a digital multimeter measured at the amplifier.
	Speaker impedance less than 2 ohms per channel	If you are using 4 ohm speakers you cannot have more than two speakers wired in parallel per channel. Amp will not operate into 2 ohms bridged.
No output on channels	Speaker wires not connected to speakers properly	Refer to pages 6 – 8 for proper installation.
	Input hooked up incorrectly	

Specifications

XA Series 2-Channel Amplifiers

Frequency Response	20 Hz-20 kHz ± 0.5 dB
Signal to Noise Ratio @ Rated Power	>100 dB
Channel Separation @ Ref. Power	>65 dB, 1 kHz
THD & IMD @ Ref. Power into 2 ohms	<0.8%
Speaker Impedance	2-8 ohms
Input Impedance	47 k ohms
Bass Boost Center Frequency	45Hz
Crossover	12 dB/octave, Butterworth
Power Requirement	14.4 VDC (10.8-15.6 VDC allowable)

XA2125

Power output @ 14.4 VDC, 20-20 kHz	
(4 ohms)	125 Watts per channel RMS, < 0.5% THD
(2 ohms)	175 Watts per channel RMS, < 0.8% THD
(4 ohms) bridged	350 Watts per channel RMS, < 0.8% THD
Dimensions	3" x 11.125" x 10" (76mm x 283mm x 254mm)

XA275

Power output @ 14.4 VDC, 20-20 kHz	
(4 ohms)	75 Watts per channel RMS, < 0.5% THD
(2 ohms)	100 Watts per channel RMS, < 0.8% THD
(4 ohms) bridged	200 Watts per channel RMS, < 0.8% THD
Dimensions	3" x 11.125" x 8.375" (76mm x 283mm x 213mm)

XA250

Power output @ 14.4 VDC, 20-20 kHz	
(4 ohms)	50 Watts per channel RMS, < 0.5% THD
(2 ohms)	75 Watts per channel RMS, < 0.8% THD
(4 ohms) bridged	150 Watts per channel RMS, < 0.8% THD
Dimensions	3" x 11.125" x 8.375" (76mm x 283mm x 213mm)

Specifications subject to change without notice.



Limited One Year Warranty— USA and Canada

Length of Warranty. This warranty from Recoton Mobile Electronics shall be in effect for a period of one year from the date of the first consumer purchase.

Persons Protected. This warranty will be enforceable by the original owner during the warranty period so long as proof of date of purchase from an authorized Jensen dealer is presented whenever warranty service is required.

What is Covered. Except as otherwise specified below, this warranty covers all defects in material and workmanship in this product. The following are not covered: damage resulting from accident, misuse, abuse, neglect, product modification, improper installation, incorrect line voltage, unauthorized repair or failure to follow instructions supplied with the product; damage occurring during shipment (claims must be presented to the carrier); elimination of car static or other electrical interferences; any product purchased outside USA or Canada, or on which the serial number has been defaced, modified or removed.

How You Can Get Service.

U.S. Purchasers. Please telephone Jensen at 1-800-323-4815. We will either inform you of the name and address of an authorized Jensen repair station which will service the product or will advise you to send the product to a factory service center.

Canadian Purchasers. The product should be returned to the Jensen dealer from whom it was purchased and such dealer either will service or arrange for service of the product.

If shipment of the product is required, it should be packed securely. The original dated bill of sale must always be included with the product as proof of warranty coverage.

What We Will Pay For. We will pay for all labor and material expenses required to repair the product, but you must pay any labor costs for the removal and/or installation of the product. If the product is shipped for warranty service, you must prepay the initial shipping charges, but Jensen will pay the return shipping charges if the product is returned to an address inside the USA or Canada.

Exclusion of Certain Damages. Jensen's liability is limited to the repair or replacement, at our option, of any defective product and shall not include incidental or consequential economic damages of any kind.

Some states and/or provinces do not allow limitations on how long an implied warranty lasts and/or do not allow the exclusion or limitation of incidental or consequential damages, so the above limitations and exclusions may not apply to you.

This warranty gives you specific legal rights, and you may also have other rights which vary from state to state and province to province.

JENSEN®

Recoton Mobile Electronics
A Division of Recoton Audio Corporation
A RECOTON® COMPANY
1090 Emma Oaks Trail
Lake Mary, Florida 32746

©2001 Recoton Audio Corporation