26" 720p LCD HDTV



Instruction Manual

Read all of the instructions before using this TV and keep the manual in a safe place for future reference.

Important Safety Instructions

- Read these instructions – All the safety and operating instructions should be read before this product is operated.
- Keep these instructions – The safety and operating instructions should be retained for future reference.
- Heed all warnings – All warnings on the appliance and in the operating instructions should be adhered to.
- Follow all instructions – All operating and use instructions should be followed.
- Do not use this apparatus near water – The appliance should not be used near water or moisture –for example, in a wet basement or near a swimming pool, and the like.
- Clean only with dry cloth.
- Do not block any ventilation openings. Install in accordance with the manufacture’s instructions.
- Do not install near any heat sources such as radiators, heat registers, stoves, or other apparatus (including amplifiers) that produce heat.
- Do not defeat the safety purpose of the polarized or grounding plug. A polarized plug has two blades with one wider than the other. A grounding plug has two blades and a third grounding prong. The wide blade or the third prong is provided for your safety. If the provided plug does not fit into your outlet, consult an electrician for replacement of the obsolete outlet.
- Protect the power cord from being walked on or pinched particularly at the plugs, convenience receptacles, and at the point where they exit from the apparatus.
- Only use attachments/accessories specified by the manufacturer.
- Use only with the cart, stand, tripod, bracket, or table specified by the manufacturer, or sold with the apparatus. When a cart or rack is used, use caution when moving the cart/apparatus combination to avoid injury from tip-over.
- Unplug the apparatus during lightning storms or when unused for long periods of time.
- Refer all servicing to qualified personnel. Servicing is required when the apparatus has been damaged in any way, such as power supply cord or plug is damaged, liquid has been spilled or objects have fallen into the apparatus has been exposed to rain or moisture, does not operate normally, or has been dropped.
- Please keep the unit in a well-ventilated environment.
- **WARNING:** To reduce the risk of fire or electric shock, do not expose this apparatus to rain or moisture. The apparatus shall not be exposed to dripping or splashing and that objects filled with liquids, such as vases, shall not be placed on apparatus.
- **WARNING:** The wall socket plug is used as disconnect device, the disconnect device shall remain readily operable.
- **WARNING:** The batteries shall not be exposed to excessive heat such as sunshine, fire or the like.



- This lightning flash with arrowhead symbol within an equilateral triangle is intended to alert the user to the presence of non-insulated “dangerous voltage” within the product’s enclosure that may be of sufficient magnitude to constitute a risk of electric shock.
- **Warning:** To reduce the risk of electric shock, do not remove cover (or back) as there are no user -serviceable parts inside. Refer servicing to qualified personnel.
- The exclamation point within an equilateral triangle is intended to alert the user to the presence of important operating and maintenance instructions in the literature accompanying the appliance.
- The apparatus should be connected to an electrical wall outlet with a protective grounding connection.

Contents

Caution.....	3
Safety Information.....	4
What's Included.....	5
Getting Started.....	6-7
Front / Rear View.....	6-7
TV Terminal Connections.....	7
Wall Mounting.....	7
Connecting to External Devices.....	8
Remote Control Key Functions.....	9-10
Operating Your Television.....	11-18
Select Your Onscreen Language Preference.....	12
Navigating the Onscreen Display.....	13
Choosing a TV Channel.....	13
Selecting Input Source.....	14
Video Menu Options.....	14
Picture Mode.....	14
Audio Menu Options.....	15
TV Menu Options.....	15
Channel Skip.....	16
Setup Menu Options.....	16
Caption.....	17
PC Mode.....	18
Parental Menu Options.....	19-20
USB multimedia operation.....	21
Troubleshooting.....	22-24
FCC.....	25
Specifications.....	25

Caution



The exclamation point within an equilateral triangle is intended to alert the user to the presence of important operating and maintenance (servicing) instructions in the literature accompanying the appliance.



The lightning flash with arrowhead symbol, within an equilateral triangle is intended to alert the user to the presence of uninsulated “dangerous voltage” within the products enclosure that may be of sufficient magnitude to constitute a risk of electric shock to the persons.

Safety Information

To ensure reliable and safe operation of this equipment, please read carefully all the instructions in this user guide, especially the safety information below.

Electrical safety

- The TV set should only be connected to a main power supply with voltage that matches the label at the rear of the product.
- To prevent overload, do not share the same power supply socket with too many other electronic components.
- Do not place any connecting wires where they may be stepped on or tripped over.
- Do not place heavy items on them, which may damage the leads.
- Hold the main plug, not the wires, when removing from a socket.
- During a thunderstorm or when not in using the television for long periods, turn off the power switch on the back of the television.
- Do not allow water or moisture to enter the TV or power adapter. Do NOT use in wet, moist areas, such as bathrooms, steamy kitchens or near swimming pools.
- Pull the plug out immediately, and seek professional help if the main plug or cable is damaged, liquid is spilt onto the set, if accidentally exposed to water or moisture, if anything accidentally penetrates the ventilation slots or if the set does not work normally.
- Do not remove the safety covers. There are no user serviceable parts inside. Trying to service the unit yourself is dangerous and may invalidate the product's warranty. Qualified personnel must only service this apparatus.
- To avoid battery leakage, remove exhausted batteries from the remote control, or when not using for a long period.
- Do not break open or throw exhausted batteries on a fire.

Physical safety

- Do not block ventilation slots in the back cover. You may place the TV in a cabinet, but ensure at least 5cm (2") clearance all around.
- Do not tap or shake the TV screen, or you may damage the internal circuits. Take good care of the remote control.
- To clean the TV use a soft dry cloth. Do not use solvents or petroleum based fluids.
- Do not install near any heat sources such as radiators, heat registers, stoves or other apparatus (including amplifiers) that produce heat.
- Do not defeat the safety purpose of the polarized or grounding-type plug. A polarized plug has two blades with one wider than the other. A grounding type plug has two blades and a third grounding prong, the wide blade, or the third prong is provided for your safety. If the provided plug does not fit into your outlet, consult an electrician for replacement of the obsolete outlet.
- Protect the power cord from being walked on or pinched particularly at plugs.
- Unplug the apparatus during lightning storms or when unused for long periods.
- Refer all servicing to a qualified service personnel. Servicing is required when the apparatus has been damaged in any way, such as power-supply cord or plug is damaged, liquid has been spilled, or objects have fallen into the apparatus, has been exposed to rain or moisture, does not operate normally, or has been dropped.
- Please always connect your television to a power outlet with protective ground connection.

What's Included

Unit and Accessories

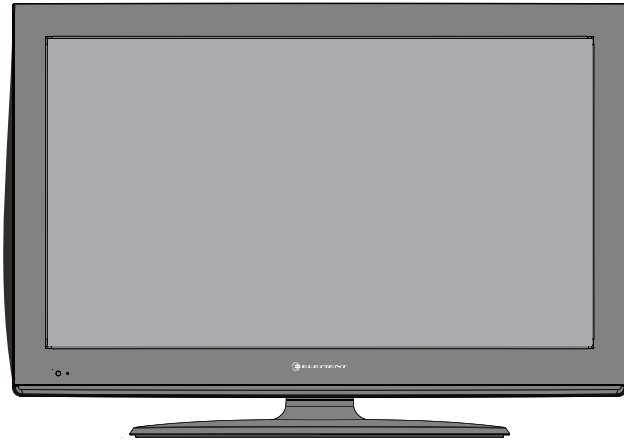

TV Set

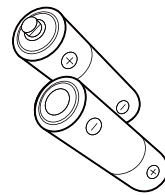

Remote control with batteries

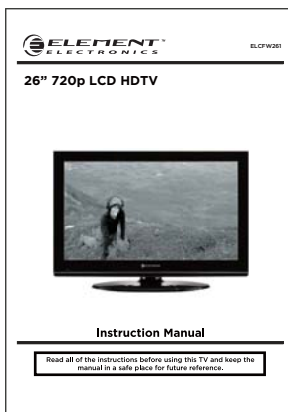

User's Manual

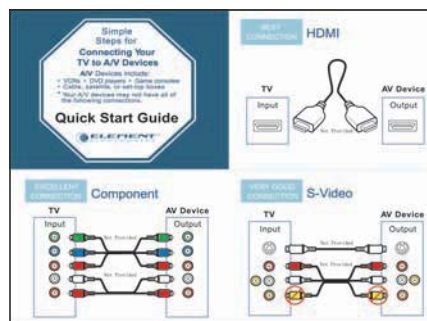

Quick Start Guide



warranty card

Getting Started

Front View

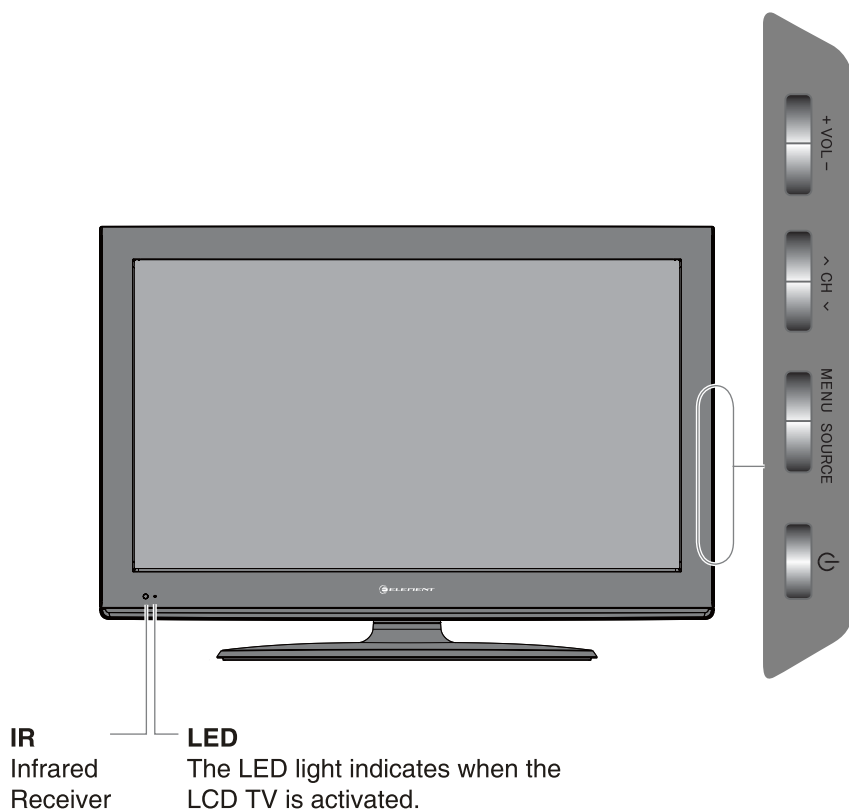

The function of the buttons are described below:

⏻ (POWER) : Turn on/standby the TV set.

SOURCE: Press to display the input source menu.

MENU: Press to display the OSD menu, press again to exit the menu.

CH ^/v: Press to scan through channels.

VOL +/-: Press to adjust the volume.

Getting Started

Rear View

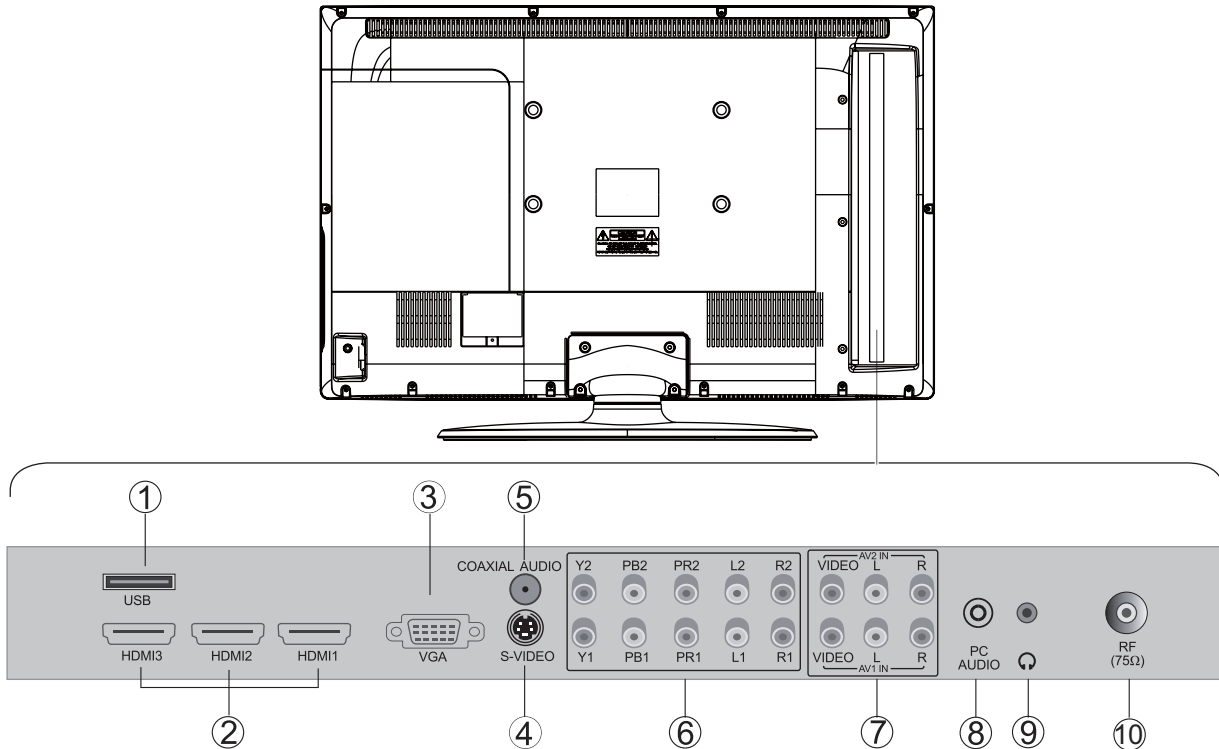

1. USB port
2. HDMI 1/HDMI2/HDMI3 input.
3. VGA input.
4. S-VIDEO input.
5. Coaxial audio signal out plug.
6. Component input terminal.
7. AV1/AV2 input.
8. PC audio input.
9. Headphone output.
10. Antenna input (75 Ohm VHF/UHF).

Wall Mounting

The TV is provided with mounting holes for a VESA approved wall mounting bracket (NOT SUPPLIED). Remove the screws holding the base to the base bracket and lift the base away (do not remove the base mounting brackets). Mount the VESA bracket using 4 x M5x20 isometric threaded screws (not supplied). Do not use screws longer than 20 mm; damage will occur to the internal parts.

Caution: Your new TV is heavy; please consult with a professional wallmount installer to perform this installation.

Connecting to external devices

Connecting external devices to your LCD TV

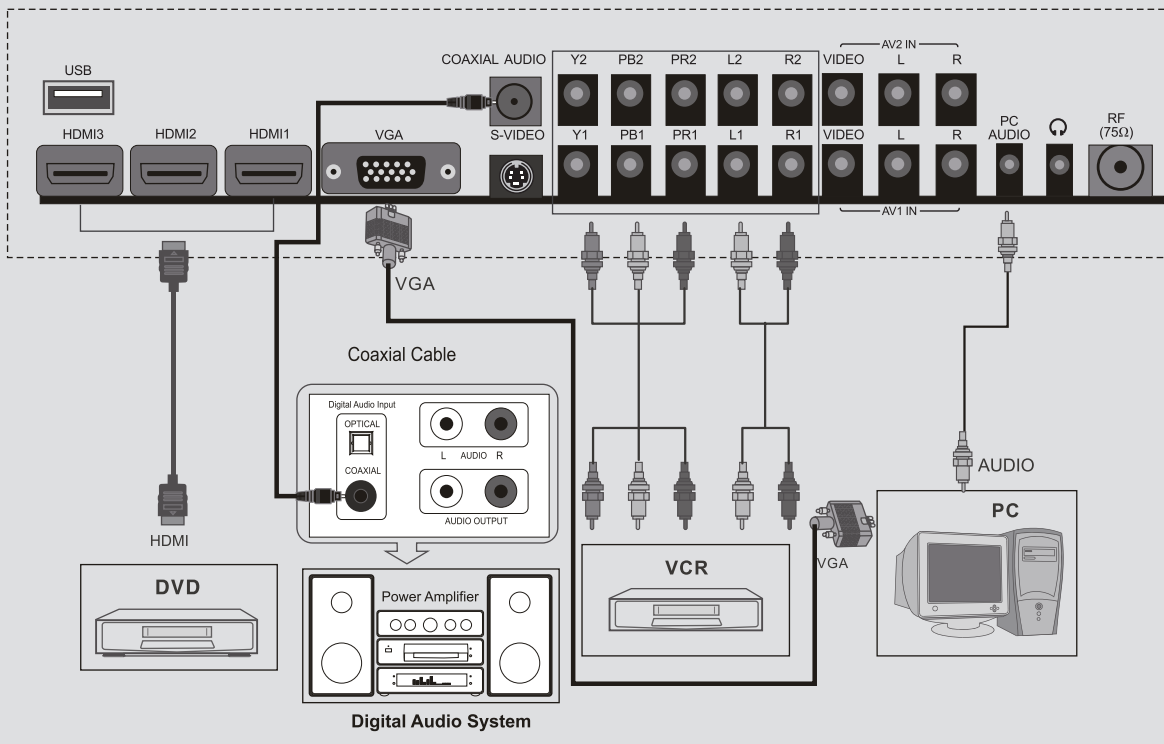
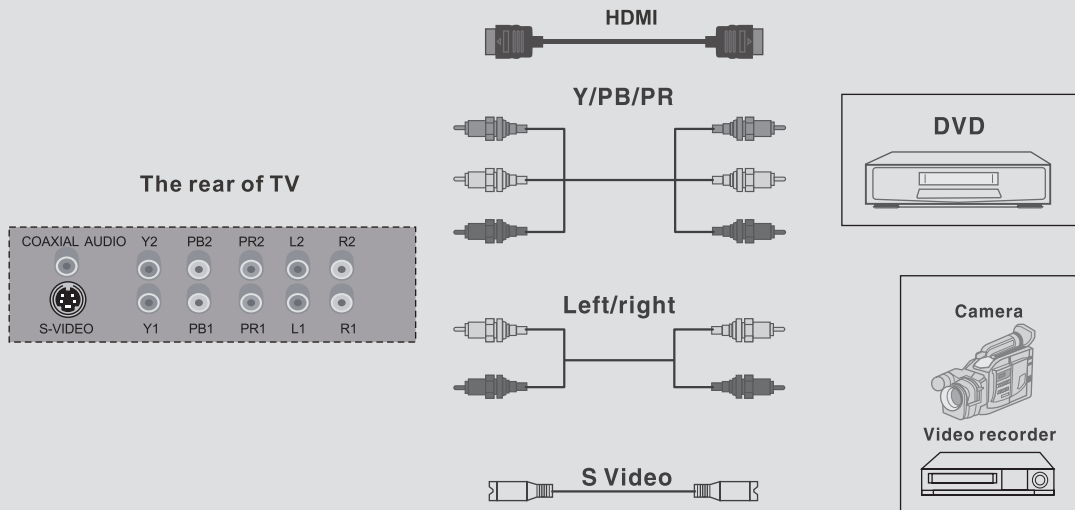

Remote Control Key Functions

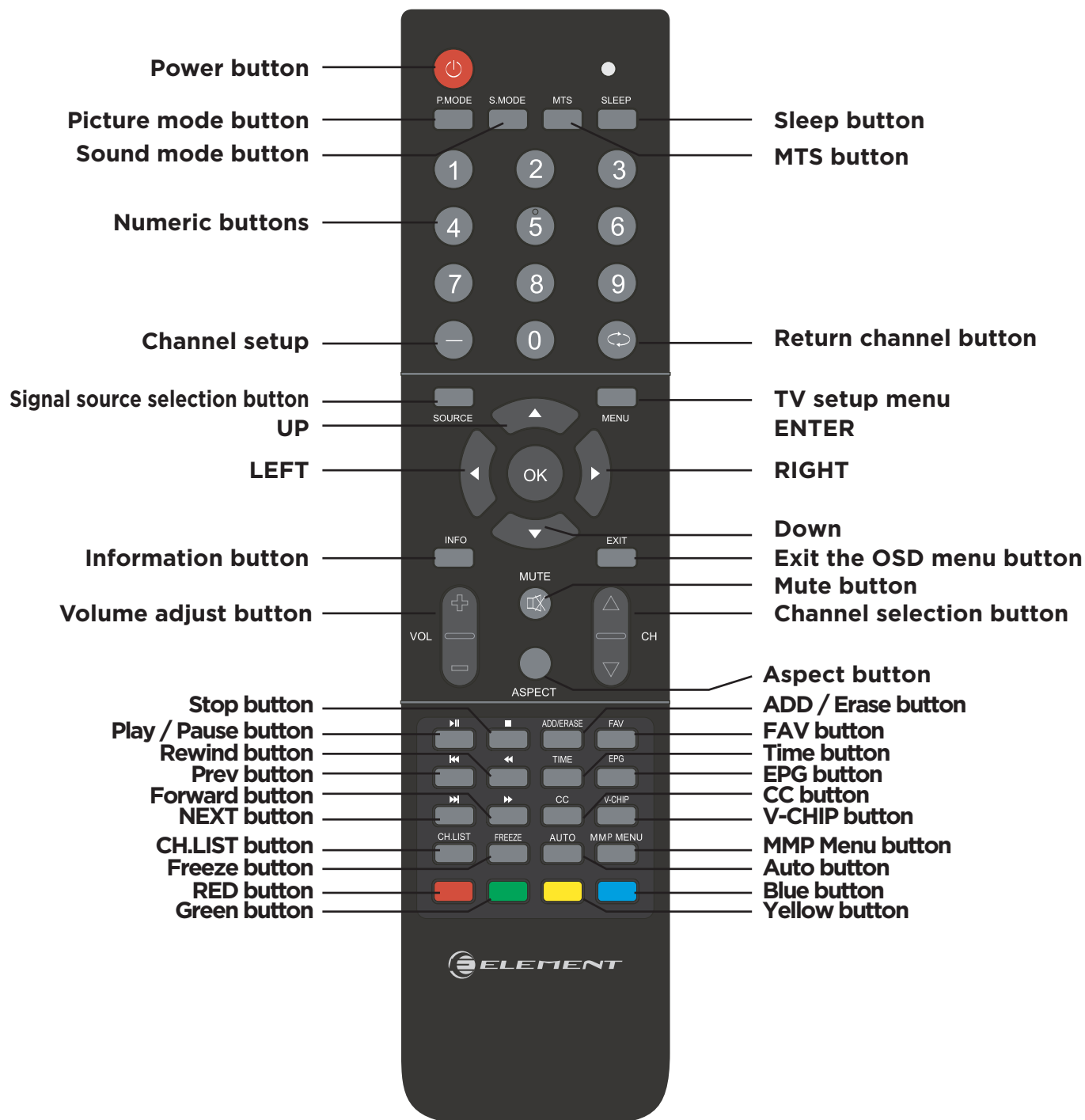

If there is light around the TV, the remote control may fail or work abnormally.
 If not using the remote for a long period of time, please remove the batteries.
 Remote control function keys to practice prevail.

Remote Control Key Functions

- POWER:** Power on/off button,press once to turn the TV on and press again to turn the TV off.
- P.MODE:** Setting the picture mode.
- S.MODE:** Setting the sound mode.
- MTS:** Press to select the audio channels.
- Make sure the TV has searched the channel and that there is a Analog Stereo / Dual Sound Signal shown on the program.
 - Then press the MTS (Multichannel Television Sound) button to select STEREO, MONO and SAP.
- SLEEP:** Sleep button,setting TV power off time.
- 0,1-9:** TV channel selection button.
- :** Press this button to enter a program number for multiple program channel such as 2-1, etc.
- ↶↷ :** Previous channel button, return to the previous channel watched.
- SOURCE:** Signal source selection button (TV/AV1/AV2/S-VIDEO/YPBPR1/YPBPR2/VGA/HDMI1/HDMI2/HDMI3/USB)
- MENU:** OSD menu button,to enter the TV setup menu.
- ▲/▼(Up/Down):** Up and down button of OSD menu. To change the OSD menu items.
- ◀/▶ (Left/Right):** Left and right button of the OSD menu. To select the OSD menu items .
- OK:** To confirm the choice with the highlighted menu item.
- INFO:** Press info button to view the current channel. Press again to remove channel information.
- EXIT:** Press the EXIT to exit operation.
- VOL+/-:** Volume adjusting button, to increase or decrease the volume.
- CH▲/▼:** Channel selection button, to increase or decrease channel.
- MUTE:** Mute button, press once to disable the audio and press again to enable the audio.
- ASPECT:** Select display mode:16:9/4:3/ZOOM/Panorama/AUTO (Only 16:9/4:3, up to 720p).
- ADD/ERASE:** Add or deleted Favorite channel.
- FAV:** Display favorite of program list.
- TIME:** Display timer for TV.
- EPG:** Electronic Program Guide function.
- CC:** Closed Caption select button CC1,CC2,CC3,CC4,TEXT1, TEXT2,TEXT3,TEXT4,OFF etc .
- V-CHIP:** Setting up parental control.
- CH.LIST:** Display program list.
- FREEZE:** Freeze picture for TV.
- AUTO:** Auto adjust(only use in the VGA source).

USB Operation

- ▶II:** Press ▶II once to pause,Press ▶II again to return to normal play.
- :** Press ■ to stop playback and clear the memory. Press ▶II button to resume play.
- ◀◀:** Press ◀◀ to play the prev chapter.
- ◀◀:** Press ◀◀ button for quick rewind search. (Note: When playing music file, this key role required length by only)
- ▶▶:** Press ▶▶ to play the next chapter.
- ▶▶:** Press the ▶▶ button for quick forward search. (Note: When playing music file, this key role required length by only)
- MMP MENU:** When playing USB, press MMP MENU to multimedia menus.

Operating Your Television

Menu Setup TV(When Using For The First Time Only)

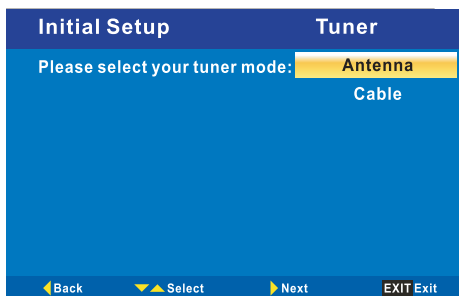
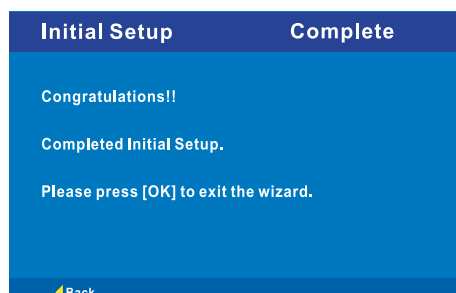
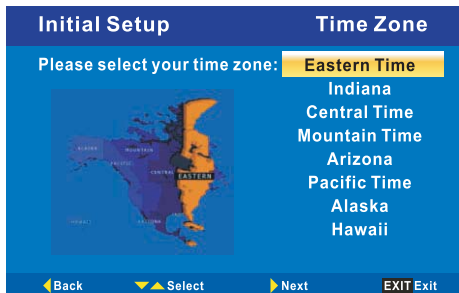
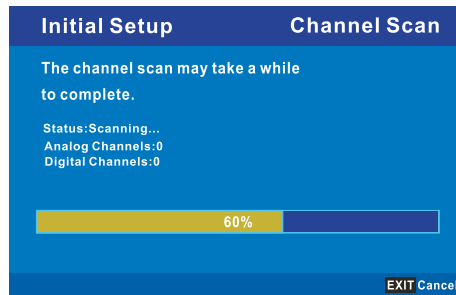
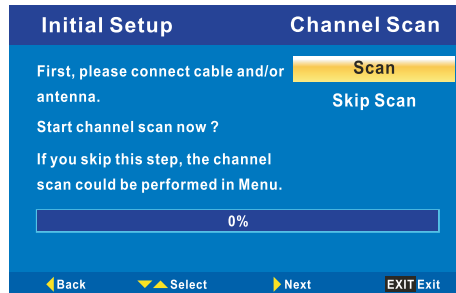
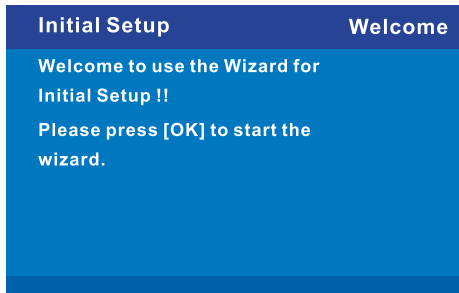

1. Turn on TV, Please press OK to start the wizard.
2. Please select your language.
3. Please select your time zone.
4. Please select your tuner.
5. Connect antenna and Press OK button start channel scan.

Operating Your Television

Basic Operations

Turning Your TV On and Off

TURN ON LCD TV

1. Connect to power with the main power cable, at this time the TV will enter STANDBY mode and the LED will be red.
2. From the STANDBY mode, use the POWER button either on the main unit or on the remote to turn your television on.

TURN OFF LCD TV

From ON mode, use the POWER button either on the main unit or on the remote to turn your television to STANDBY mode.

Select Your Onscreen Language Preference

Note: If using your LCD TV for the first time, you should select the language which will be used for displaying menus and information boxes.

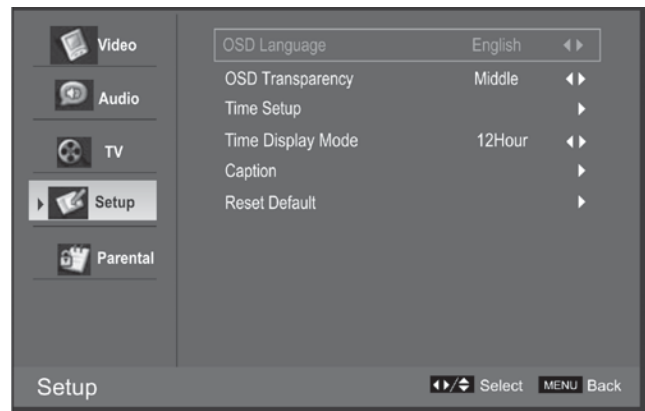
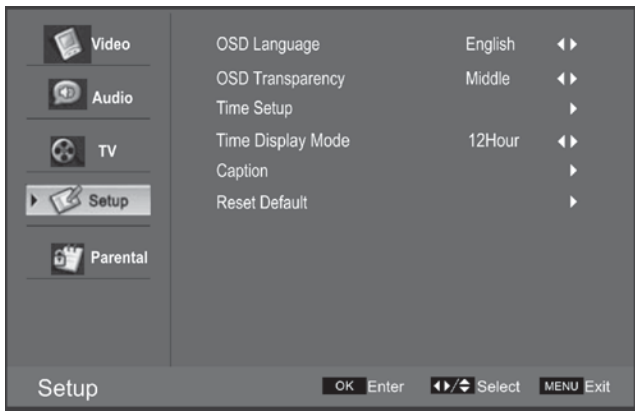

- Press MENU to display the main menu.
- Press ▲/▼ repeatedly to select the **SETUP** (left picture), press OK or ► button to enter (picture right).
- Select **OSD LANGUAGE**.
- Press ◀/▶ button to select your desired language.
- When you are satisfied with your choice, press the **MENU** to exit.

Volume Adjustment

1. Press VOL +/- to adjust the volume
2. If you want to switch the sound off, press the **MUTE** , Press again to resume.

Operating Your Television

Navigating the Onscreen Display

- Press the MENU button to display the main menu.
- Use ▲/▼ buttons to navigate and select the available menus.



Choosing a TV Channel

1. Use the **CH▲/CH▼** on the front panel or on the remote control.

- Press **CH▲** to increase the channel.
- Press **CH▼** to decrease the channel.

2. Using **0-9** remote keys.

Enter the channel number with the 0-9 remote keys, then press “**OK**” to select the channel.

For example:

1. Press 4, then press “**OK**” to select channel 4.
2. Press 4, then press 5, then press “**OK**” to select channel 45.
3. Press 1, then press 2, then press 1, finally press “**OK**” to select channel 121.

Operating Your Television

Selecting Input Source

You can display the input screen menu by pressing **SOURCE** on the remote control or **SOURCE** on the front panel, press **▲/▼** button to select, press **“OK”** to confirm.

Source	
✓	TV
	AV1
	AV2
	S-VIDEO
	YPBPR1
	YPBPR2
	VGA
	HDMI1
	HDMI2
	HDMI3
	USB

Video Menu Options

Press the **MENU** on the front panel or **MENU** on the remote control and then use **▲/▼** to select the Video menu, press **▶** or **OK** to enter (see picture below).

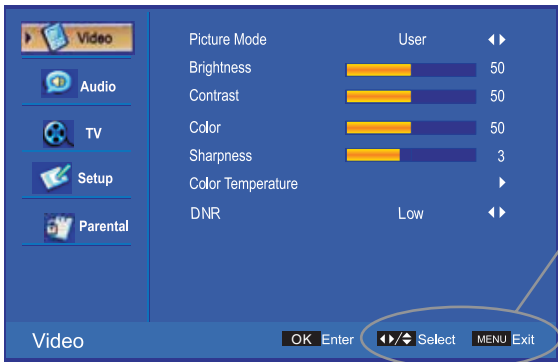

1. Use **▲/▼** to select what you want to adjust in the Video menu.
2. Press **OK** or **◀/▶** to adjust (according to the hint below)
3. When you are satisfied with your adjustment, press **MENU** to exit.

Picture Mode

Select the type of picture which best corresponds to your viewing preferences by selecting Picture Mode in the **VIDEO** menu. You may select the picture mode directly by pressing the **P.MODE** button on the remote control.

Brightness

Press **▲/▼** and then use **◀/▶** to adjust the brightness of the picture.

Contrast

Press **▲/▼** and then use **◀/▶** to adjust the contrast of the picture.

Color

Press **▲/▼** and then use **◀/▶** to adjust the color of the picture.

Sharpness

Press **▲/▼** and then use **◀/▶** to adjust the sharpness of the picture.

Color Temperature

Press **“OK”** to enter the submenu for Color Temperature. Press **◀/▶** to select mode

----- User, Cool, Standard, Warm

Then press **▲/▼** to select **“R Gain, G Gain, B Gain”** in **“User”** mode.

DNR

Press **▲/▼** and then use **◀/▶** to adjust the Digital Noise Reduction of the picture.

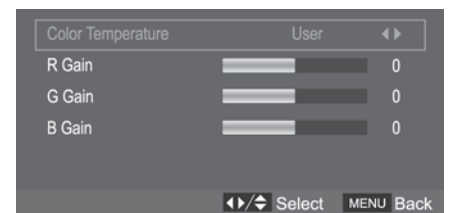

Operating Your Television

Audio Menu Options

Press **MENU** on the front panel or **MENU** on the remote control and then use **▲/▼** to select the **AUDIO** menu, press **▶** or **OK** to enter (see picture below).

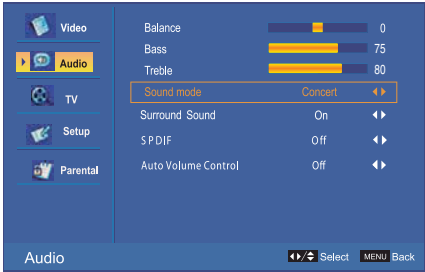

1. Use **▲/▼** to select the option you want to adjust in the Audio menu.
2. Press **OK** or **◀/▶** to adjust (according to the hints below)
3. When you are satisfied with your adjustment, press **MENU** to exit.

Audio Mode

You can select the type of sound which best corresponds to your listening requirements by selecting Sound in **AUDIO** menu.

Balance

Press **▲/▼** and then use **◀/▶** to adjust the audio output between left and right speakers.

Bass

Press **▲/▼** and then use **◀/▶** increase or decrease the level of the lower-pitched sounds.

Treble

Press **▲/▼** and then use **◀/▶** to increase or decrease the level of higher-pitched sounds

Sound Mode

Press **◀/▶** to select one of the modes options: Concert, Jazz, User, Voice

Surround Sound

Press **◀/▶** to switch Surround Sound On or Off

SPDIF

Press **◀/▶** to select between PCM, OFF or RAW

Auto Volume Control

Press **◀/▶** to switch auto volume control On or Off. This function allows volume to be controlled automatically.

TV Menu Options

Press the **MENU** on the front panel or **MENU** on the remote control and then use **▲/▼** to select the **TV** menu, press **▶** or **OK** to enter (see picture below).

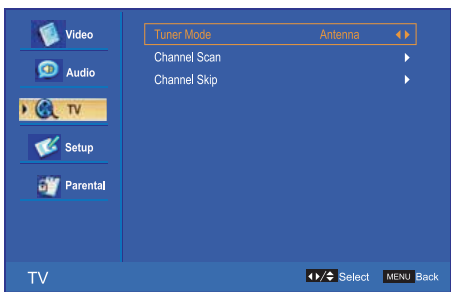

1. Use **▲/▼** to select the option you want to adjust in the TV menu.
2. Press **OK** or **◀/▶** to enter the desired function.
3. When you are done, press **MENU** to exit.

Tuner Mode

Select the signal input mode: Antenna or Cable

Channel Scan

Select **“Channel Scan”**; press **OK** to start the channel scan. Press **MENU** to stop or continue until the scan is complete; Stopping in the middle of a scan will save the scanned channels up to the stop point.

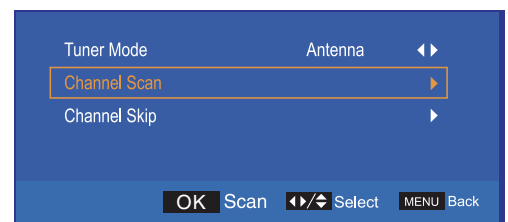

Operating Your Television

Channel Skip

Select “**Channel Skip**”; press **OK** to enter the submenu. Press **▲/▼** to select the desired channel, then press **OK**.

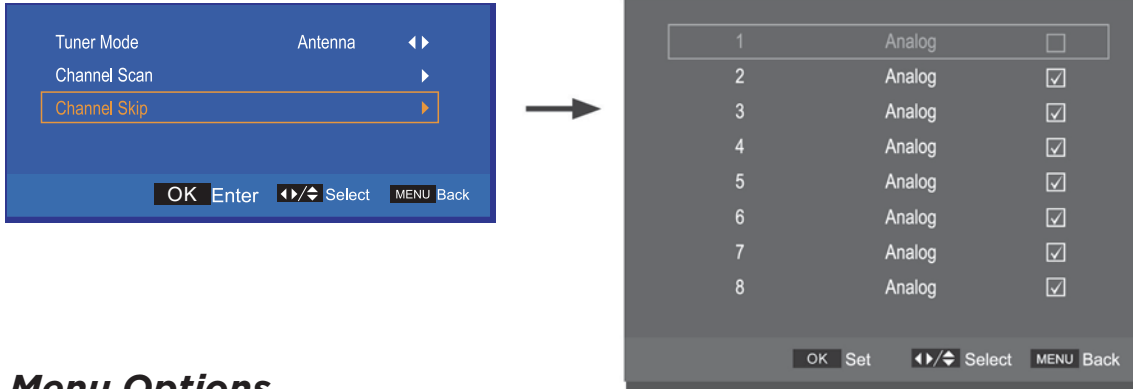

Setup Menu Options

Press the **MENU** on the front panel or **MENU** on the remote control and then use **▲/▼** to select the Setup menu, press **▶** or **OK** to enter (see picture below).

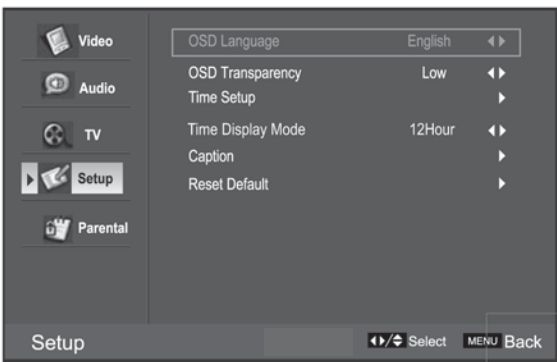

1. Use **▲/▼** to select the option you want to adjust in the setup menu.
2. Press **OK** or **◀/▶** to adjust (according to the hint below).
3. When you are done with your adjustments, press **MENU** to exit.

OSD Language

To select language of the OSD menu

OSD Transparency

Press **◀/▶** to select the transparency mode Low, High or Middle.

Time Setup

Select: “**Time Setup**”, Press **OK** to enter the submenu.

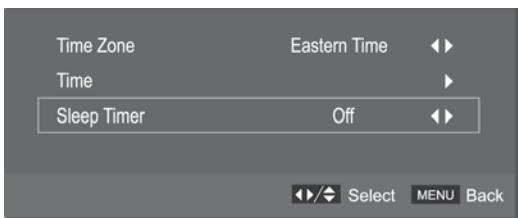

Time zone

To select time zone

Time

To set power on and power off times. Press **OK** to enter to set the time.

Sleep timer

To select the sleep timer

Time Display mode

To select the Time Display Mode in 12 or 24 hour mode

Caption

(See next page)

Reset Default

Select “**Reset Default**”, Press **OK**, and it will display “**Are you sure**”, select “**OK**” to select the factory default settings.

Operating Your Television

Caption

Select “Caption”, press OK to enter the submenu (see below)

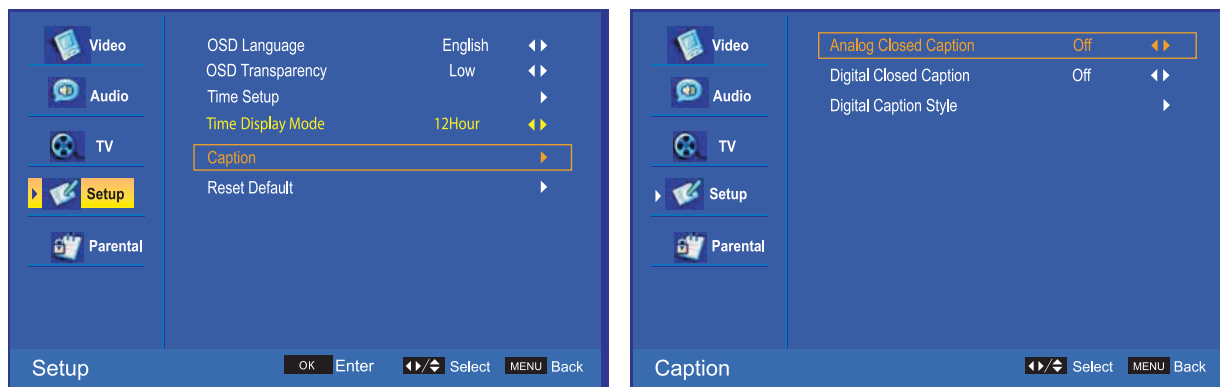

Analog Closed Caption

Press ◀/▶ to select CC1/CC2/CC3/CC4/TEXT1/TEXT2/TEXT3/TEXT4, or select Off.

Digital Closed Caption

Press ◀/▶ to select Service1/Service2/Service3/Service4/Service5/Service6, or select Off.

Digital Caption Style

This item allows you to set the closed caption, press OK to enter Digital Caption style menu:

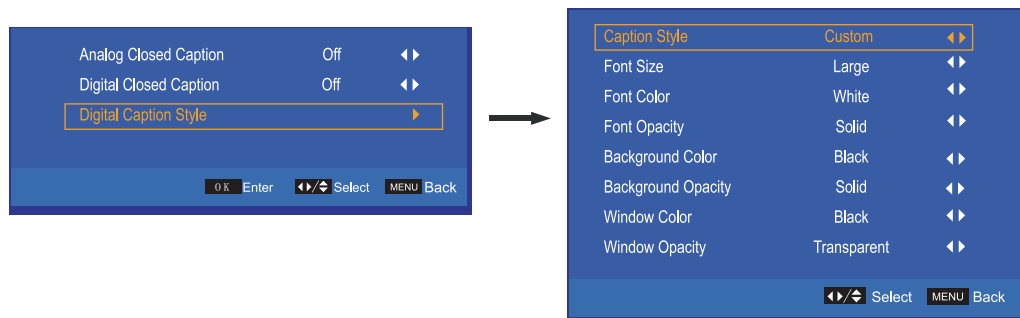

- Caption Style: press ◀/▶ to select As Broadcaster or Custom. When you select As Broadcaster, all other options are disabled and can not be adjusted.
- Font Size: press ◀/▶ to select Medium/Large or Small.
- Font Color: press ◀/▶ to select Red/Green/Blue/Yellow/Magenta/Cyan/Black or White.
- Font Opacity: press ◀/▶ to select Solid/Transparent or Translucent.
- Background Color: press ◀/▶ to select Black/White/Red/Green/Blue/Yellow/Magenta/ or Cyan.
- Background Opacity: press ◀/▶ to select Solid/Transparent or Translucent.
- Window Color: press ◀/▶ to select Black/White/Red/Green/Blue/Yellow/Magenta/ or Cyan.
- Window Opacity: press ◀/▶ to select Solid/Transparent or Translucent.

Operating Your Television

PC Mode

Connect your computer to the TV using a VGA cable. Change the source to VGA, then press “MENU” and select “VGA”

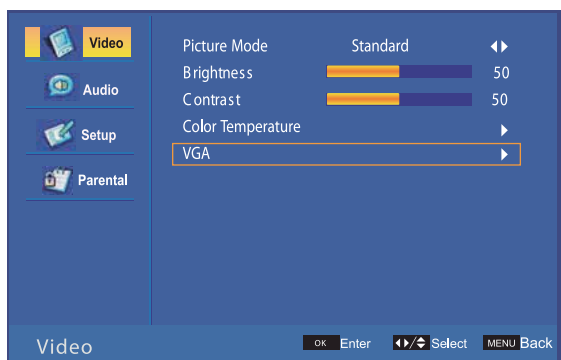

Press OK to enter PC setup



Auto adjust your picture to best position
H. position: Manually control horizontal position
V. position: Manually control vertical position
Phase: Manually control phase
Clock: Manually control clock

VGA Mode

Resolution	Vertical Frequency (Hz)
640X480	60
800X600	60
1024X768	60
1360X768	60

Parental Menu Options

Parental Menu Options

Press the **MENU** on the front panel or remote control and then use **▲/▼** to select the Parental menu, Press **▶** or **OK** to enter (see picture below).



The factory default password code is **0000** to enter the parental menu.

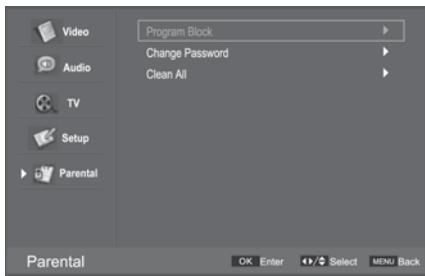

Change Password: select “**Change Password**”, press **OK** to enter the submenu, and change the password. Press **MENU** to cancel.
Clean All: Select “**Clean All**”, Press **OK** and it will display “Are you sure”, select “**OK**” to default to the factory settings.

Program Block

Rating Enable: Press **◀/▶** to select On/Off.

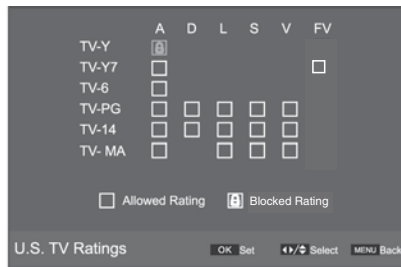
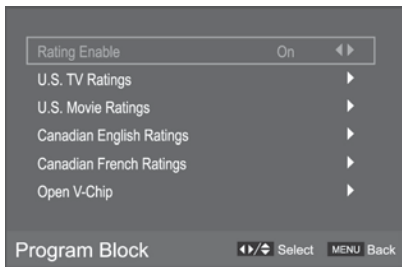

U.S. TV Ratings: Press **OK** to enter, and use **◀/▶** and **▲/▼** to select, and press **OK** to confirm.

U.S. Movie Ratings: Press **OK** to enter, and use **▲/▼** to select, and press **OK** to confirm.

Canadian English Ratings: Press **OK** to enter, and use **▲/▼** to select, and press **OK** to confirm.

Canadian French Ratings: Press **OK** to enter, and use **▲/▼** to select, and press **OK** to confirm.

Open V-Chip

Select “**V-Chip**”. Press **OK** to enter and you will see an item “Tumbolia region, alternate US”. Press **OK** again to enter the V-Chip menu (picture below).

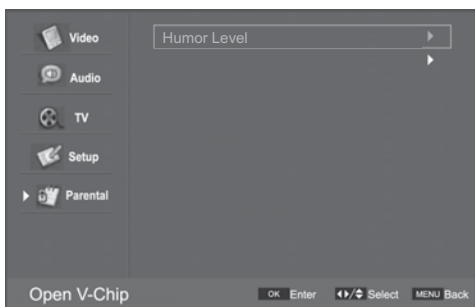

You can select any item, press **OK** to enter, use **▲/▼** to select, press **OK** to confirm.

Parental Menu Options

Parental Control

Press Enter to enter the sub-menu and then use the 0-9 to enter the correct password: 0,0,0,0. If used, this option feature can “block” undesirable programming from appearing on the TV. Parental Control offers the user a wide variety of options and settings that restrict or “block” the programming that can appear on the TV. Parental Control allows the user the capability of defining which program rating they consider acceptable, to the younger more sensitive viewer. It can be preset and turned either on or off by the user who specifies the secret 4-number code, the password. The number of hours blocked are specified. General audiences and children blocks should be both programmed into the TV’s memory. Viewer ratings are specified for both TV and the motion picture industry; both rating systems should be used, for complete coverage. The ratings are based on the ages of children.

Overview

To ensure complete coverage for all TV programs, (movies and regular TV shows) choose a rating for MPAA, from the selections below, as well as ratings from the TV Parental Guidelines Rating Systems below, using the Age Block option for General Audiences, and for children. In addition to those, you may wish to add additional restrictions from the content block menu, and submenus examples below.

Things to Consider before Setting up Parental Control

Determine which rating you consider acceptable to the viewer. (For example, if you choose TV-PG, more restrictive ratings will be automatically blocked; the viewer will not be able to see: TV-PG, TV-14, or TV-MA rated programming.) Do you want to block the auxiliary video source entirely? (Blocks the signal sent by the equipment, such as VCR, connected to the TV Audio/Video input jacks) Or leave unblocked, then choose allowable ratings. Block program “Content” based on individual parameters such as: Strong Dialog, Bad Language, Sex Scenes, Violence Scenes, or Fantasy. Violent Scenes; in Content Blk option. Select a secret password, in the Set Password option, using the numbers keys on the remote. Do not forget the password, it is the only way you can access the Parental Control menu and change rating selections, or turn Parental Control off. Do you want the Parental Control to be active at all times? If not, you can turn it on or off with the Lock On/Off option.

- You can set different Parental Control viewing restrictions for general audiences and for children, both can be active at the same time.
- Simply specifying one content block such as Sex Scenes, will not automatically restrict the programming that appears from the video sources.
- Even if you choose to leave the AUX inputs unblocked, the ratings you specify will automatically restrict the programming that appears from the video sources.
- You can not disable Parental Control by disconnecting the TV from power. Block hours will be automatically reset to the original block time setting specified if power is disconnected.

Information

Motion Picture Association of America (MPAA) Rating System

Grade		Meaning
G	General Audiences	Content not offensive to most viewers
PG	Parental Guidance Suggested	Content is such that parents may not want their children to view the program
PG-13	Parental Guidance Strongly Cautioned	Program is inappropriate for preteens, with a greater degree of offensive material suggested than a PG rated program
R	Restricted viewing	Not for children under 17, Strong element of sex and/or violence
NC-17	No Children Under age 17	Not for children under 17 under any circumstances. Strong sexual content
X	Hard Core Films	Same as NC-17 rating
No Rating	No Rating	MPAA Not Rated

TV Parental Guideline Rating System

Grade		Meaning
TV-Y	Young Children	Content not offensive to most viewers
TV-Y7	Children 7 and over	Considered suitable for children over 7, may contain Fantasy Violence Scenes
TV-G	Parental Audience	Considered suitable for all audiences; children may watch unattended
TV-PG	Parental Guidance	Suggested Unsuitable for younger children, may contain; Suggestive Dialogue, Bad Language, Sex, and Violence Scenes
TV-14	Parents Strongly Cautioned	Unsuitable for children under 14, may contain: Strong Dialogue, Bad Language, Sex, and Violence Scenes
TV-MA	Mature Audience Only	Adults only, may contain Strong Dialogue, Bad Language, Sex, and Violent Scenes

Canadian Rating: Canadian English is used throughout all English-speaking Canada (C, C8+, G, PG, 14+, 18+). Canadian French is used in Quebec (G, 8 ans+, 13 ans+, 16 ans+, 18 ans+)

Note: The V-Chip will automatically block certain categories that are “more restrictive”. If you block TV-Y category, then TV-Y7 will be automatically blocked. Similarly, if you block TV-G category, then all the categories in the “young adult” will be blocked (TV-G, TV-PG, TV-14, and TV-MA).

USB multimedia operation

Multimedia Operation: Music

Press MMP MENU buttons to select Music button to enter, Press **OK** button to return to the previous menu. Press **▲▼** buttons to select the Media Type to view, Press to select the audio channels Music, Press **OK** button to play the music. Press **EXIT** button to exit.

NOTE: file format just supported : MP3

Press **▶||** button once to pause,
 Press **▶||** button again to return to normal play
 Press **■** button to stop playback.
 Press **◀◀** button to play the previous track.
 Press **▶▶** button to play the next track
 Press **◀◀** button for quick revind search
 Press **▶▶** button for quick forward search
 Press **RED** button to select repeat play mode.
 Press **GREEN** button to select shuffle play mode
 Press **YELLOW** button to audio only mode.
 Press **BLUE** button to display the currently music information

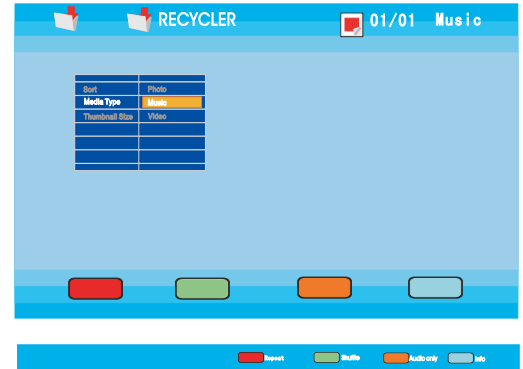

Multimedia Operation: Picture and Music mode

First play music ,press **EXIT** button exit Music mode and into picture mode, select you want view picture, press **OK** button to play picture, then the Music can playback background of Picture mode.

Press **◀◀** button to play the previous track.
 Press **▶▶** button to play the next track.
 Press **RED** button to select play and pause.
 Press **GREEN** button to select play duration and rotate.
 Press **YELLOW** button to effect mode.
 Press **BLUE** button to display the currently photo information.

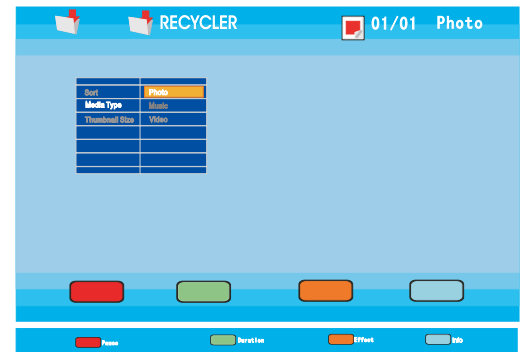

Multimedia Operation: Video

Press MMP MENU buttons to select Video button to enter, Press **EXIT** button to return to the previous menu. Press **▲▼** buttons to select the Media Type to view, Press to select the audio channels video, Press **OK** button to play the video. Press **▲▼◀▶** buttons to select the Video to view, Press **OK** button to play the movie. Press **EXIT** button to exit.

NOTE: file format just supported : SD MPEG1(.dat .mpg) / SD MPEG2(.vob .mpg), not supported divx file and other HD video format.

Press **▶||** button once to pause,
 Press **▶||** button again to return to normal play
 Press **■** button to stop playback.
 Press **◀◀** button to play the previous track.
 Press **▶▶** button to play the next track.
 Press **◀◀** button for quick revind search.
 Press **▶▶** button for quick forward search.
 Press **RED** button for select repeat mode.
 Press **GREEN** button for select time.
 Press **YELLOW** button for select the audio channels.
 Press **BLUE** button for info.

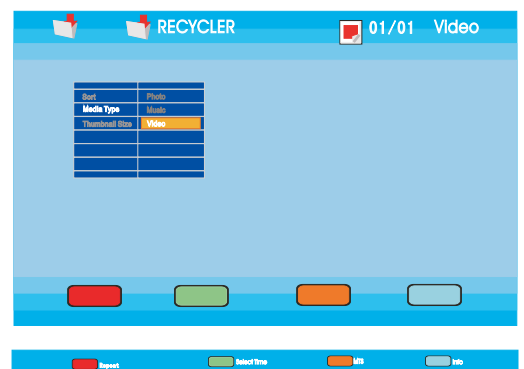

Troubleshooting

If your television does not operate normally or does not turn on, please check the following troubleshooting questions. Remember to also check the other connected electronic devices, such as DVDs or Blu-ray players to pinpoint any problem. If the television still fails to operate normally, please contact technical support (refer to Warranty page).

SYMPTOM	POSSIBLE CAUSE	REMEDY
Dead. No LED lit	No power to the TV.	Check all connections to the TV's AC socket.
Dead. No LED lit orange	Set in standby mode.	Press either the Power button or the Standby button on the remote control.
Blue screen	No signal.	Press INPUT button to select the correct source
	Incorrect source selected.	
Noisy, snowy, ghosting picture (TV)	Poor antenna signal.	If using an indoor antenna, try adjusting the antenna position. Check antenna connections
No sound	Sound "Mute".	Turn sound "Mute" OFF.
	Volume set too low.	Check volume settings.
	External leads not connected "if used".	Check that all external leads are connected properly.

Troubleshooting

Before contacting the service technician, perform the following simple checks. If any problem still persists, unplug the LCD TV and call for assistance.

PROBLEM	POSSIBLE SOLUTION
No sound and picture	<ul style="list-style-type: none"> - Check that the main plug has been connected to a wall outlet - Check that you have pressed the POWER button on the front of the TV set - Check the picture contrast and the brightness setting
Red LED indicator light	Set in standby mode. Press either the POWER button or the Standby button on the remote control
Normal picture but no sound	<ul style="list-style-type: none"> - Check the volume - Sound muted? Press the MUTE button - Try another channel, the problem may be with the broadcast - Are the audio cables installed properly?
The remote control does not work	<ul style="list-style-type: none"> - Check to see if there are any objects between the TV and remote control causing obstruction - Are batteries installed with correct polarity (+ / -) - Correct remote operating mode set: TV, VCR, etc? - Install new batteries
Power suddenly turns off	<ul style="list-style-type: none"> - Is the sleep timer set? - Check the power control settings. Power may be interrupted - No broadcast on the station tuned
Picture appears slowly after switching on	- This is normal, the image is muted during the product start up process. Please contact a service provider if the picture has not appeared after 5 minutes
Poor Color or picture	<ul style="list-style-type: none"> - Adjust the color in Menu option - Keep a sufficient distance between the product and the VCR - Try another channel, the problem may be with the broadcast - Are the VIDEO cables installed properly? - Activate any function to restore the brightness of the picture
Horizontal/vertical bars or picture shaking	- Check for local interference, such as an electrical appliance or power tool
Blue Screen	- Press INPUT button to select correct source
Poor reception on some channels	<ul style="list-style-type: none"> - Station or cable experiencing problems. Tune to another station - Station signal is weak, reorient antenna to receive better reception - Check for sources of possible interference
Lines or streaks in pictures	- Check the antenna (change the direction of the antenna)
No output from one of the speakers	- Adjust balance in the Menu option

Troubleshooting

NOTE: When there is a problem in VGA mode (only when VGA mode is applied)

PROBLEM	POSSIBLE SOLUTION
The signal is out of range	- Adjust resolution, horizontal frequency, or vertical frequency - Check whether the signal cable is connected or loose - Check the input source
Vertical bar or stripe on background, horizontal noise and incorrect position	Set the auto configure or adjust clock, phase or H/V position
Screen Color is unstable or is a single Color	- Check the signal cable - Re-install the PC video card

Maintenance

Early malfunctions can be prevented. Careful and regular cleaning can extend the amount of time you will have with your new TV. Be sure to turn the power off and unplug the power cord before you begin any cleaning.

Cleaning the screen

1. A great tip to dust off your screen. Wet a soft cloth in a mixture of lukewarm water and a little fabric softener or dish washing detergent. Wring the cloth until it's almost dry, and then use to wipe the screen.
2. Make sure the excess water is off the screen, then let air-dry before you turn on the TV.

Cleaning the Cabinet

To remove dirt or dust, wipe the cabinet with a soft, dry, lint-free cloth. Please be sure not to use a wet cloth.

Extended Absence



If you expect to leave your TV dormant for a long time (such as a vacation), it is a good idea to unplug the power cord to protect against possible damages from lightning or power surges.

The FCC Wants You To Know



This equipment has been tested and found to comply with the limits for a Class B digital device, pursuant to Part 15 of the FCC Rules. These limits are designed to provide reasonable protection against harmful interference in a residential installation.

This equipment generates, uses, and can radiate radio frequency energy and, if not installed or used in accordance with the instructions, may cause harmful interference to radio communications. However, there is no guarantee that interference will not occur in a particular installation.

If this equipment does cause harmful interference to radio or television reception, which can be determined by turning the equipment off and on, the user is encouraged to try to correct the interference by one or more of the following measures: 1) reorient or relocate the receiving antenna; 2) increase the separation between the equipment and the receiver; 3) connect the equipment to an outlet on a circuit different from that to which the receiver is connected; 4) consult the dealer or an experienced radio/TV technician for additional suggestions.

Any changes or modifications not expressly approved by the party responsible for compliance could void the user's authority to operate the equipment. Where shielded interface cables have been provided with the product or specified additional components or accessories elsewhere defined to be used with the installation of the product, they must be used in order to ensure compliance with FCC regulation.

Canadian DOC statement
Standard Television Receiving Apparatus Canada BETS-7
This Class B digital apparatus complies with Canadian ICES-003.

Specifications

Panel Size	26 inches diagonally
Display Type	LCD
Panel Technology	TFT
Panel 60 Hz vs 120 Hz	60Hz
Display Resolution	720
HD Compatible	up to 1080p
Panel Resolution	1366 x 768
Aspect Ratio	16:9
Dynamic Contrast Ratio - panel	800:1
Brightness (Centre Typ.) cd/m ²	400
Response Time (G to G)	6.5 ms
Lamp Life (Typ. Hours)	50,000 hours
Horizontal Viewing Angle (At CR>10)	160
Vertical Viewing Angle (At CR>10)	150



This product contains electrical or electronic materials. The presence of these materials may, if not disposed of properly, have potential adverse effects on the environment and human health.

Presence of this label on the product means it should not be disposed of as unsorted waste and must be collected separately. As a consumer, you are responsible for ensuring that this product is disposed of properly. To find out how to properly dispose of this product, please go to www.elementelectronics.com and click on Sustainability.

HDMI™

This TV incorporates High-Definition Multimedia Interface (HDMI™) technology. HDMI, the HDMI logo and High-Definition Multimedia Interface are trademarks or registered trademarks of HDMI Licensing LLC.