

CHICAGO

Electric[®]Power Tools

INDUSTRIAL MIG WELDER - 250 AMP

Model 91146

ASSEMBLY AND OPERATING INSTRUCTIONS



3491 Mission Oaks Blvd., Camarillo, CA 93011
Visit our Web site at: <http://www.harborfreight.com>

Copyright© 2005 by Harbor Freight Tools[®]. All rights reserved. No portion of this manual or any artwork contained herein may be reproduced in any shape or form without the express written consent of Harbor Freight Tools.

For technical questions, please call 1-800-444-3353.

PRODUCT SPECIFICATIONS

Item	Description
Electrical Requirements	Input Voltage: 220V / 60 Hz / 45 Input Amperage Power Cord: 10 AWG @ 6' Long Power Plug: 220V (not included), Requires 50 Amp Circuit
Duty Cycles	60% @ 250 Amps / 100% @ 195 Amps
Maximum Welding Thickness Capacity	Up To 3/8" Mild Steel
Welding Current	30 – 250 Amps
Required Wire Sizes	.024" To .047" Diameter
Wire Control Settings	Internal, Spot & Pause, 4 Time, & 2 Time
Gun Coolant Type	Air Cooled
Fuse Type	3 AMP Buss Fuse
Gun Power Cable Length	13'
Ground Clamp Cable Length	13'
Wheels	Front: Swivel Castors / 3-1/4" Diameter x 1" Thick Rear: Rigid / 8" Diameter x 1-1/2" Thick on 7/8" Diameter Axle
Accessories	Gas Pressure Regulator w/Flow Meter Welding Gloves / Face Mask / 1 Torch Liner / 5 Spare Tips
Weight	187 Pounds

SAVE THIS MANUAL

You will need this manual for the safety warnings and precautions, assembly, operating, inspection, maintenance and cleaning procedures, parts list and assembly diagram. Keep your invoice with this manual. Write the invoice number on the inside of the front cover. Keep this manual and invoice in a safe and dry place for future reference.

UNPACKING

When unpacking, check to make sure all the parts shown on the **Parts Lists on pages 26 and 27** are included. If any parts are missing or broken, please call Harbor Freight Tools at the number shown on the cover of this manual as soon as possible.

GENERAL SAFETY RULES

WARNING!

READ AND UNDERSTAND ALL INSTRUCTIONS
Failure to follow all instructions listed below may result in electric shock, fire, and/or serious injury.
SAVE THESE INSTRUCTIONS

WORK AREA

1. **Keep your work area clean and well lit.** Cluttered benches and dark areas invite accidents.
2. **Do not operate welding equipment in explosive atmospheres, such as in the presence of flammable liquids, gases, or dust.** Welding equipment creates sparks which may ignite the dust or fumes.

3. **Keep bystanders, children, and visitors away while operating welding equipment.** Distractions can cause you to lose control. Protect others in the work area from arc rays, sparks, and slag. Provide barriers or shields as needed.

ELECTRICAL SAFETY

1. **Grounded welding equipment must be plugged into an outlet properly installed and grounded in accordance with all codes and ordinances. Never remove the grounding prong or modify the plug in any way. Do not use any adapter plugs. Check with a qualified electrician if you are in doubt as to whether the outlet is properly grounded.** If the welding equipment should electrically malfunction or break down, grounding provides a low resistance path to carry electricity away from the user.
2. **Avoid body contact with grounded surfaces such as pipes, radiators, ranges, and refrigerators.** There is an increased risk of electric shock if your body is grounded.
3. **Do not expose welding equipment to rain or wet conditions.** Water entering welding equipment will increase the risk of electric shock.
4. **Do not abuse the Power Cord. Never use the Power Cord to carry welding equipment or pull the Plug from an outlet. Keep the Power Cord away from heat, oil, sharp edges, or moving parts. Replace damaged Power Cords immediately.** Damaged Power Cords increase the risk of electric shock.
5. **When operating welding equipment outside, use an outdoor extension cord marked “W-A” or “W”.** These extension cords are rated for outdoor use, and reduce the risk of electric shock.

**The minimum extension cord size for this tool is 6 GAUGE for cords UP TO 25' LONG.
CORDS LONGER THAN 25' SHOULD NOT BE USED WITH THE WELDER.**

PERSONAL SAFETY

1. **Stay alert. Watch what you are doing, and use common sense when operating welding equipment. Do not use welding equipment while tired or under the influence of drugs, alcohol, or medication.** A moment of inattention while operating welding equipment may result in serious personal injury.

2. **Dress properly. Do not wear loose clothing or jewelry. Contain long hair. Keep your hair, clothing, and gloves away from hot or moving parts.** Loose clothes, jewelry, or long hair can be caught in hot or moving parts.
(See page 8, number 3, for recommended safety clothing.)
3. **Avoid accidental starting. Be sure the Power Switch is off before plugging in.** Plugging in welding equipment with the Power Switch on invites accidents.
4. **Remove adjusting keys or wrenches before turning on the welding equipment.** A wrench or a key that is left attached to an electrically charged part of the welding equipment may result in personal injury.
5. **Do not overreach. Keep proper footing and balance at all times.** Proper footing and balance enables better control of the welding equipment in unexpected situations.

TOOL USE AND CARE

1. **Use clamps (not included) or other practical ways to secure and support the workpiece to a stable platform.** Holding the work by hand or against your body is unstable and may lead to loss of control.
2. **Do not force the welding equipment. Use the correct equipment for your application.** The correct equipment will do the job better and safer at the rate for which it is designed.
3. **Do not use the power tool if the Power Switch does not turn it on or off.** Any equipment that cannot be controlled with the Power Switch is dangerous and must be replaced.
4. **Disconnect the Power Cord Plug from the power source before making any adjustments, changing accessories, or storing the welding equipment.** Such preventive safety measures reduce the risk of starting the welding equipment accidentally.
5. **Store idle welding equipment out of reach of children and other untrained persons.** Welding equipment is dangerous in the hands of untrained users.
6. **Maintain welding equipment with care. Keep equipment clean and dry.** Properly maintained equipment is less likely to malfunction and is easier to control. Do not use damaged welding equipment. Tag damaged equipment "Do not use" until repaired.
7. **Check for misalignment or binding of moving parts, breakage of parts, and any other condition that may affect the equipment's operation. If damaged, have the equipment serviced before using.** Many accidents are caused by poorly maintained equipment.

8. **Use only accessories that are recommended by the manufacturer for your model.** Accessories that may be suitable for one type of welding equipment may become hazardous when used on another type of equipment

SERVICE

1. **Equipment service must be performed only by qualified repair personnel.** Service or maintenance performed by unqualified personnel could result in a risk of injury.
2. **When servicing welding equipment, use only identical replacement parts. Follow instructions in the “*Inspection, Maintenance, And Cleaning*” section of this manual.** Use of unauthorized parts or failure to follow maintenance instructions may create a risk of electric shock, burns, or other injury.

GROUNDING



Improperly connecting the grounding wire can result in the risk of electric shock. Check with a qualified electrician if you are in doubt as to whether the outlet is properly grounded. Do not modify the power cord plug provided with the tool. Never remove the grounding prong from the plug. Do not use the tool if the power cord or plug is damaged. If damaged, have it repaired by a service facility before use. If the plug will not fit the outlet, have a proper outlet installed by a qualified electrician.

GROUNDING EQUIPMENT: EQUIPMENT WITH THREE PRONG PLUGS

1.  **WARNING!** The Power Cord requires the attachment of a **220 volt, grounded, 3-Prong Plug** (not included). For safety purposes, only a qualified, certified, electrician should attach a Plug to the Power Cord. Never modify the Plug in any way. To comply with the National Electric Code, and to provide additional protection from the risk of electrical shock, this product should only be connected to a 220 volt electrical outlet that is protected by a Ground Fault Circuit Interrupter (GFCI).
2. The grounding prong in the plug is connected to the green wire inside the cord to the grounding system in the welding equipment. The green wire in the cord must be the only wire connected to the equipment's grounding system and must never be attached to an electrically "live" terminal. **(See Figure A.)**
3. Your welding equipment must be plugged into an appropriate outlet, properly installed and grounded in accordance with all codes and ordinances. The plug and outlet should look like those in the following illustration. **(See Figure A.)**

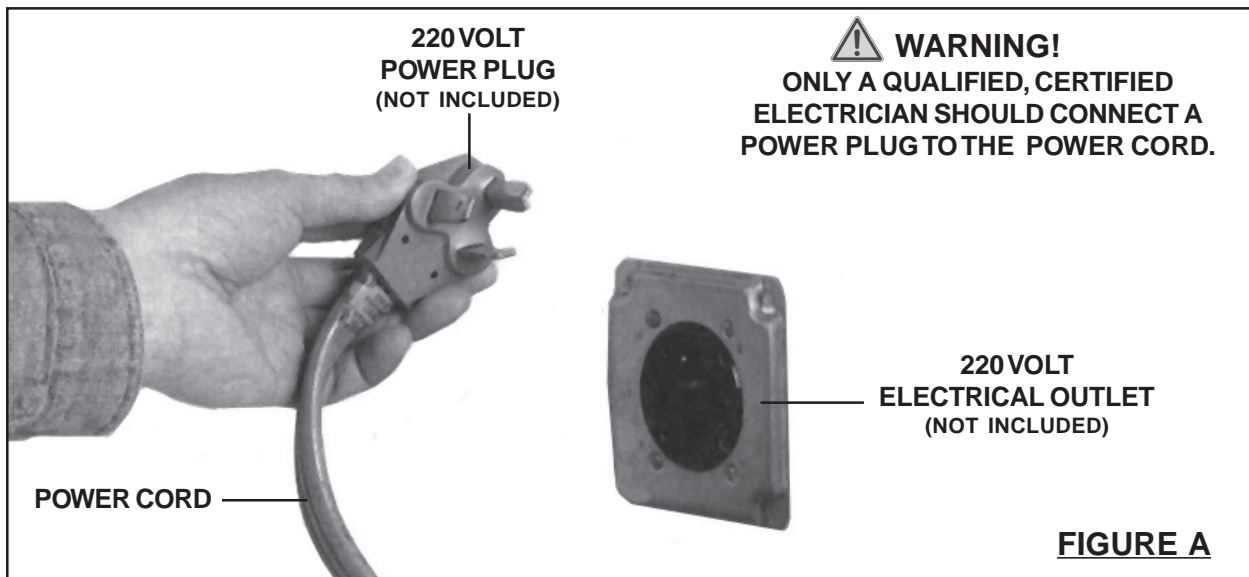

EXTENSION CORDS

**The minimum extension cord size for this tool is 6 GAUGE for cords UPTO 25' LONG.
CORDS LONGER THAN 25' SHOULD NOT BE USED WITH THIS WELDER.**

1. **Grounded** welding equipment require a three wire extension cord.
2. As the distance from the supply outlet increases, you must use a heavier gauge extension cord. Using extension cords with inadequately sized wire causes a serious drop in voltage, resulting in loss of power and possible tool damage.
The minimum extension cord gauge for this tool is 6 AWG for cords up to 25' long. Cords longer than 25' should not be used with this welder.
3. The smaller the gauge number of the wire, the greater the capacity of the cord. For example, a 14 gauge cord can carry a higher current than a 16 gauge cord.
4. When using more than one extension cord to make up the total length, make sure each cord contains at least the minimum wire size required.
5. If you are using one extension cord for more than one tool, add the nameplate amperes and use the sum to determine the required minimum cord size.
6. If you are using an extension cord outdoors, make sure it is marked with the suffix "W-A" ("W" in Canada) to indicate it is acceptable for outdoor use.
7. Make sure your extension cord is properly wired and in good electrical condition. Always replace a damaged extension cord or have it repaired by a qualified electrician before using it.
8. Protect your extension cords from sharp objects, excessive heat, and damp or wet areas.

SYMBOLOLOGY



	Double Insulated
	Canadian Standards Association
	Underwriters Laboratories, Inc.
V ~	Volts Alternating Current
A	Amperes
no xxxx/min.	No Load Revolutions per Minute (RPM)





FIGURE C

SPECIFIC SAFETY RULES

1. **Maintain a safe working environment.** Keep the work area well lit. Make sure there is adequate surrounding workspace. Always keep the work area free of obstructions, grease, oil, trash, and other debris. Do not use the Welder in areas near flammable chemicals, dusts, and vapors.
2. **Maintain labels and nameplates on the Welder.** These carry important information. If unreadable or missing, contact Harbor Freight Tools for a replacement.
3. **Prevent eye injury and burns.** Wearing and using personal safety clothing and safety devices reduce the risk of injury. Wear ANSI approved safety impact eyeglasses with a welding helmet featuring at least a number 10 shade lens rating. Leather leggings, rubber soled, fire resistant shoes or boots should be worn when using this Welder. Do not wear pants with cuffs, shirts with open pockets, or any clothing that can catch and hold molten metal or sparks. Keep clothing free of grease, oil, solvents, or any other flammable substances. Wear dry, insulating gloves and protective clothing. Wear an approved head covering to protect head and neck. Use aprons, cape, sleeves and shoulder covers, and bibs designed and approved for welding procedures. When welding overhead or in confined spaces, wear flame resistant ear plugs or ear muffs to keep sparks out of ears.
4. **Avoid overexposure to fumes and gases.** Always keep your head out of the fumes. Do not breathe the fumes. Use enough ventilation or exhaust, or both, to keep fumes and gases from your breathing zone and general area. Where ventilation is questionable, have a qualified technician take an air sampling to determine the need for corrective measures. Use mechanical ventilation to improve air quality. If engineering controls are not feasible, use an approved respirator. Work in a confined area only if it is well ventilated, or while wearing an air-supplied respirator. Follow OSHA guidelines for *Permissible Exposure Limits* (PEL's) for various fumes and gases. Follow the American Conference of Governmental Industrial Hygienists recommendations for *Threshold Limit Values* (TLV's) for fumes and gases. Have a recognized specialist in Industrial Hygiene or Environmental Services check the operation and air quality and make recommendations for the specific welding situation.
5. **Do not perform welding or cutting operations near chlorinated hydrocarbon vapors produced by degreasing or painting.** The heat generated by arc rays can react to form phosgene, a highly toxic gas.
6. **Irritation of the eyes, nose, and throat are symptoms of inadequate ventilation.** Take immediate steps to improve ventilation. Do not continue operations if symptoms persist.

7. **When welding or cutting in small areas, the operator should be externally accompanied by another person (standing *near* the enclosed work area) to observe accident prevention procedures.**
8. **When welding or cutting, be aware that high frequency radiation may be produced which can interfere with radio navigation, safety devices, computers, and communications equipment.** Before operating, have a qualified technician check out that possibility.
9. **Keep high frequency source doors and panels tightly shut.** Keep spark gaps at the correct settings. Use proper grounding and shielding to minimize the possibility of interference. Keep all cables close together and close to the ground. Locate the welding or cutting operation as far as possible from sensitive electronic equipment, or have the electronic equipment shut down temporarily.
10. **Prevent accidental fires.** Remove any combustible material from the work area. When possible, move the work to a location well away from combustible materials. If relocation is not possible, protect the combustibles with a cover made of fire resistant material. Remove or make safe all combustible materials for a radius of 35 feet (10 meters) around the work area. Use a fire resistant material to cover or block all open doorways, windows, cracks, and other openings. Enclose the work area with portable fire resistant screens. Protect combustible walls, ceilings, floors, etc., from sparks and heat with fire resistant covers. If working on a metal wall, floor, ceiling, etc., prevent ignition of combustibles on the other side by moving the combustibles to a safe location. If relocation of the combustibles is not possible, designate someone to serve as a fire watch, equipped with a fire extinguisher, during the welding process and at least one half hour after the welding is completed. Do not place the torch on any material other than bare concrete until the torch is completely cooled. Do not weld on materials having a combustible coating or combustible internal structure such as walls or ceilings, without an approved method for eliminating the hazard. Do not dispose of hot slag in containers holding combustible materials. Keep a fire extinguisher nearby, and know how to use it. After welding, make a thorough examination for evidence of fire. Be aware that easily visible smoke or flame may not be present for some time after the fire has started. Do not weld in atmospheres containing dangerously reactive or flammable gasses, vapors, liquids, and dust. Provide adequate ventilation in work areas to prevent accumulation of flammable gases, vapors, or dust. Do not apply heat to a container that has held an unknown substance or a combustible material whose contents, when heated, can produce flammable or explosive vapors. Clean and purge containers before applying heat. Vent closed containers, including castings, before preheating or welding. **Note:** Use caution when welding galvanized metal; toxic gases are formed and must be ventilated properly.
11. **Read and understand all instructions and safety precautions as outlined in the manufacturer's manual for the material you will weld.**

12. **Industrial applications must follow OSHA requirements.**
13. **Never plug the Power Cord of this product into an electrical outlet while standing on a wet or damp surface.**
14. **Connect the earth ground as near as possible to the operating area.** Earth connections to structural parts of the building or other places distant to the operating area will reduce their effectiveness and increase the danger of electric shock.
15. **In addition to grounding the workpiece with the Welder Grounding Clamp, an earth grounding of the workpiece is recommended.** Ground it directly to an earth pipe or grounding rod with a separate cable of appropriate size.
IMPORTANT: Only a qualified, certified electrician should perform this procedure.
16. **Do not touch the welding wire if you are in contact with the workpiece, ground, or another welding wire from a different machine.**
17. **Do not allow the welding wire to touch earth ground.** Accidental earth discharges may cause overheating and fire hazards.
18. **Do not pass equipment cables through or near lifting chains, crane cables, or any electrical lines.**
19. **Never use the Welder near water.** Ensure that the surrounding area and cutting objects are dry. Do not spray water or other liquids on or near the Welder.
20. **Avoid all direct contact between the skin and wet garments and metal parts under electrical power.** Check that gloves and protective clothing are dry.
21. **Never leave the Welder unattended when it is plugged into an electrical outlet.** Make sure to unplug it from its electrical outlet before leaving the area.
22. **Do not unplug the Welder by pulling on the Power Cord. Keep the Power Cord away from heated surfaces.**
23. **Always turn off the Welder in the event of a power failure.**
24. **Significant DC electrical voltage exists after turning off and unplugging the Welder.** Discharge the electrode to ground before handling.

25. **Performance of this Welder may vary depending on variations in local line voltage.** Extension cord usage may also affect tool performance.
26. **Always turn off the Welder and unplug the unit from its electrical outlet before performing any inspection, maintenance, or cleaning procedures.**
27. **Use the right tool or attachment for the right job.** Do not attempt to force a small tool or attachment to do the work of a larger industrial tool or attachment. There are certain applications for which this product was designed. It will do the job better and more safely at the rate for which it was intended. Do not modify this product, and do not use this product for a purpose for which it was not intended.
28. **Proper cylinder care:** Secure cylinders to the Base of the Welder, a wall, or post to prevent them from falling. All cylinders should be used and stored in an upright position in a well ventilated area. Never drop or strike a cylinder. Do not use cylinders that have been dented. Cylinder caps should be used when moving or storing cylinders. Empty cylinders should be kept in specified areas and clearly marked "empty". Never use oil or grease on any inlet connector, outlet connector, or cylinder valve. Additional specific instructions for the safe handling of cylinders should be supplied by your cylinder supplier and covered under local, state, and federal regulations governing pressurized gases.
29.  **WARNING!** The brass components of this product contain lead, a chemical known to the State of California to cause birth defects (or other reproductive harm). (*California Health & Safety code 25249.5, et seq.*)
30.  **WARNING!** This product, when used for welding, cutting, and similar applications, produces chemicals known to the State of California to cause cancer and birth defects (or other reproductive harm). (*California Health & Safety code 25249.5, et seq.*)
31.  **WARNING!** People with pacemakers should consult with their physician(s) before using this product. Operation of electrical equipment in close proximity to a heart pacemaker could cause interference or failure of the pacemaker.
32.  **WARNING!** The warnings, precautions, and instructions discussed in this instruction manual cannot cover all possible conditions and situations that may occur. It must be understood by the operator that common sense and caution are factors which cannot be built into this product, but must be supplied by the operator.

PRODUCT OVERVIEW

1. This Welder is designed for MIG/MAG welding on mild steel, stainless steel, and nonferrous materials up to 3/8" thickness. Additional features of this unit are as follows: **(See Figure D.)**

- A. Constant voltage transformer with step-up adjustment.
- B. Digital step-less electronic speed control.
- C. 2/4 Times, interval, and spot/pause welding.
- D. Pre-gas and post-gas flow.
- E. Soft start, burnback.
- F. Real-time digital volt-amp meter.
- G. Two inductance outlets (High & Low).
- H. Easy connect, twist-lock, male and female welding cables.
- I. Forced air cooling system.
- J. Thermal overload protection.

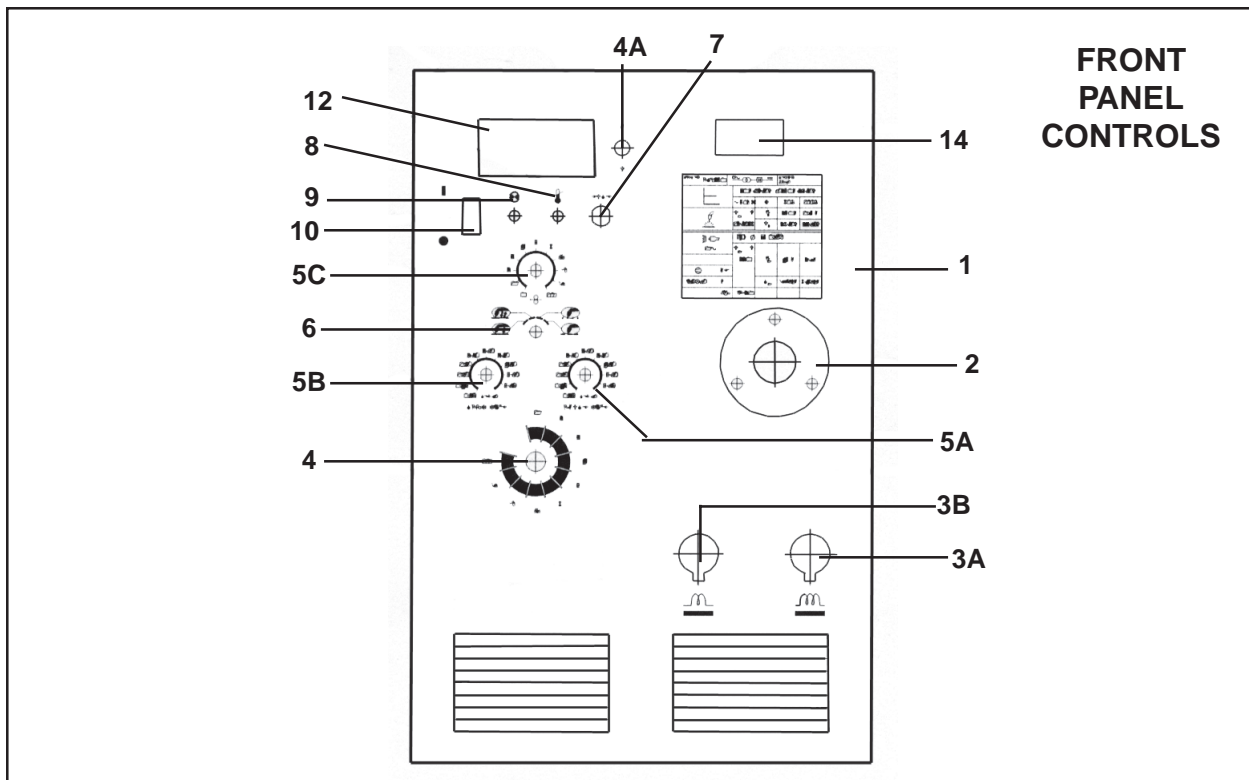

Part #	Description	Part #	Description
1	Front Panel	5C	Wire Speed Potentiometer
2	MIG Gun Outlet	6	Wire Speed Mode Selector
3A	High Inductance Outlet	7	Fuse
3B	Low Inductance Outlet	8	Over-Heating LED
4	Voltage Selector	9	Operating LED
4A	Voltage Selector Switch	10	Power Switch
5A	Pause Timer	12	Digital Volt/AMP Display
5B	Spot Timer	14	Digital Wire Feed Speed Display

FIGURE D

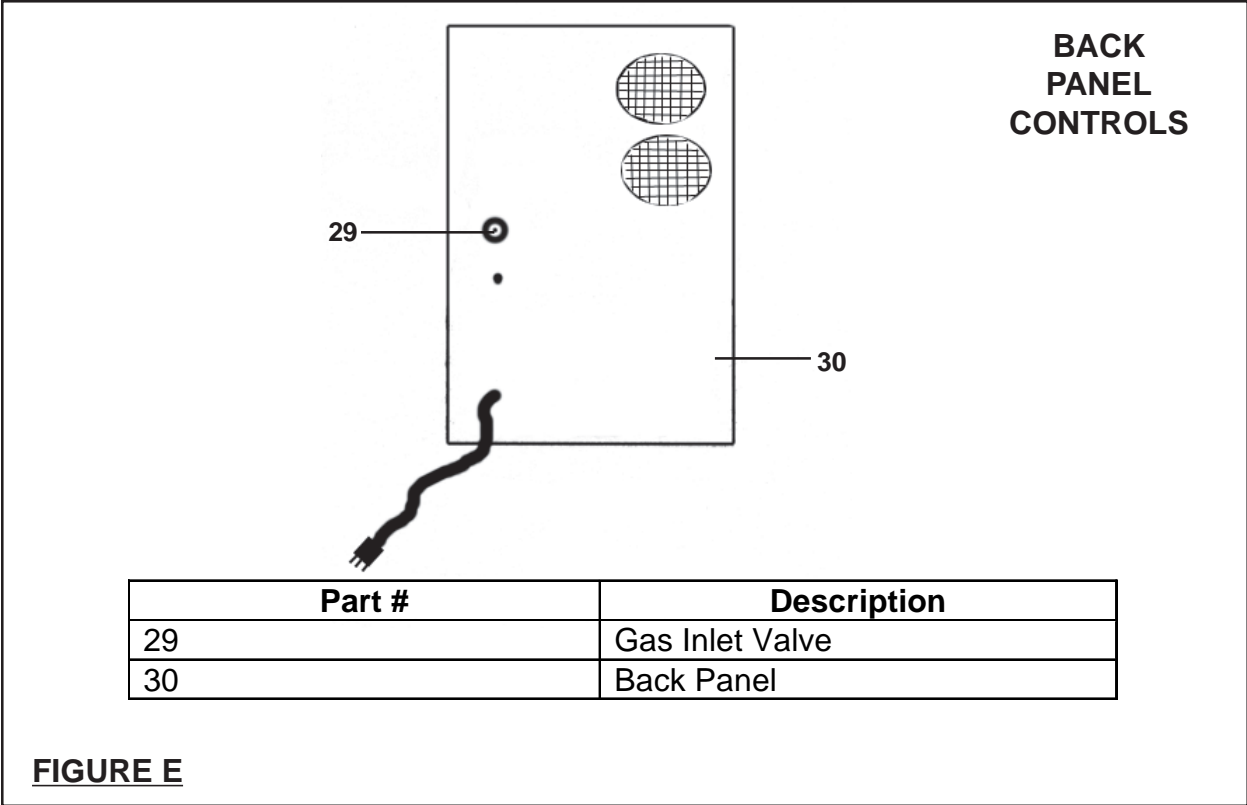

FIGURE E

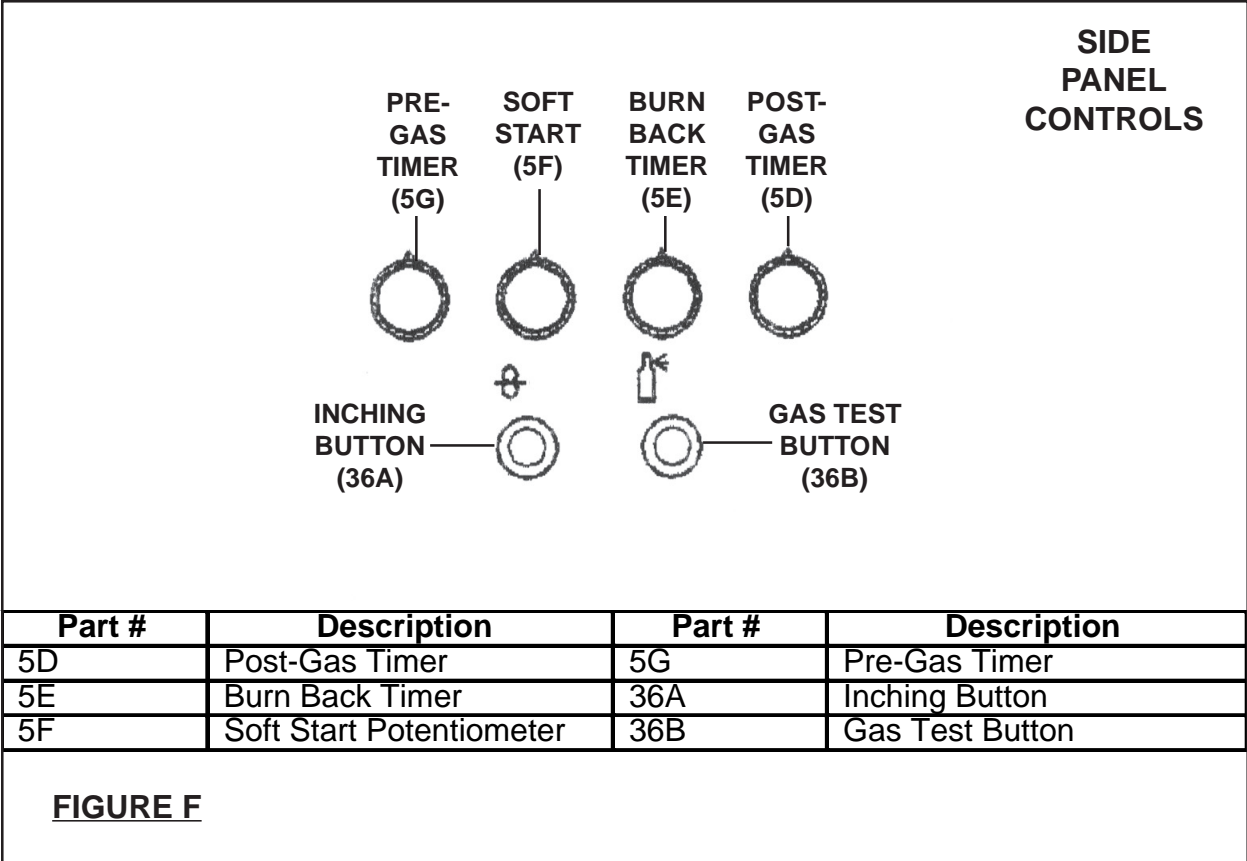



FIGURE F

ASSEMBLY INSTRUCTIONS

NOTE: For additional references to the parts listed in the following pages, refer to the **Assembly Diagrams on pages 26 and 28.**

To Attach A Power Cord Plug:

1.  **WARNING!** Only a qualified, certified electrician should attach a 220 volt Power Plug (not included) to the Power Cord of the Welder.
2. For further instructions, refer to **page 5** and **page 6** of this manual.

To Attach The Rear Wheels And Front Castor Wheels:

1.  **WARNING!** Prior to performing any further assembly procedures, make sure the Power Cord Plug of the Welder is unplugged from its electrical outlet.
2. To attach the two Rear Wheels (47) to the Welder, slide a Wheel onto each end of the Axle located at the rear of the Base (19). Secure both Wheels to the Axle by inserting one Cotter Pin through each end of the Axle. Once inserted, make sure to spread each Cotter Pin to keep them in place. **(See Figure G.)**
3. To attach the two Front Castor Wheels (48) to the Welder, align the four holes in each top plate of a Castor Wheel with the four *threaded* mounting holes located in each corner at the bottom/front of the Welder. Use four Bolts (45) and four Washers (46) to secure each Castor Wheel to the Base. **(See Figure G.)**

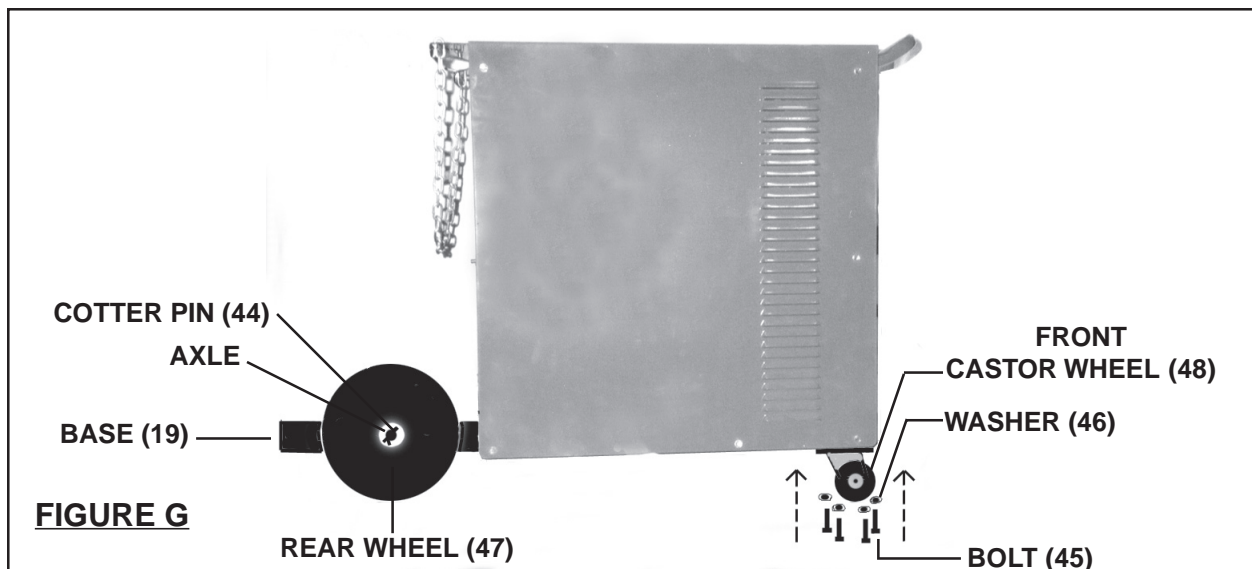

To Attach The Gun Power Cable And Ground Clamp Cable:

1. Insert the plug of the Gun Power Cable (40A) firmly into the MIG Gun Outlet (2). **(See Figure H.)**
2. Insert the plug of the Ground Clamp Cable (201) firmly into the High Inductance Outlet (3A) or the Low Inductance Outlet (3B). **NOTE:** The High Inductance Outlet allows for a higher welding heat, resulting in a deeper penetration of the welding wire into thicker workpieces. The Low Inductance Outlet allows for a lower welding heat, and is typically used for thinner workpieces. **(See Figure H.)**

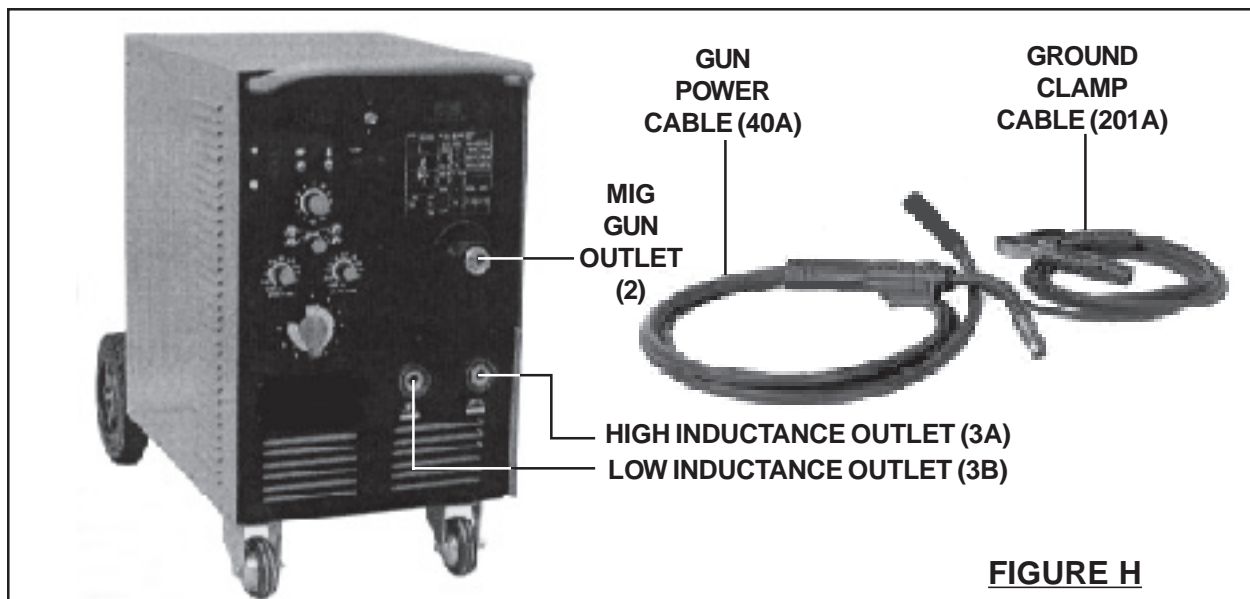

To Install Welding Wire Spool And Adjust Wire Tension:

1. Open the Upper Right Side Panel (21), and remove the Lock Knob on the Wire Spool Hub (33). **(See Figure I, next page.)**
2. Insert a Wire Spool (not included) onto the Wire Spool Hub (33), and secure the Wire Spool in place with the Lock Knob. **(See Figure I.)**
3. Lower the Pressure Adjustment Knob on the Wire Feeder (37). **(See Figure I.)**
4. Hold the welding wire tightly to keep it from unraveling. Then pull out about 6" of welding wire from the Wire Spool, and make a clean cut at the end of the wire. **(See Figure I.)**
5. Push the welding wire through the guides in the Wire Feeder (37) and about 4" into the Gun Power Cable (40A). Continue to hold the wire. **(See Figure I.)**

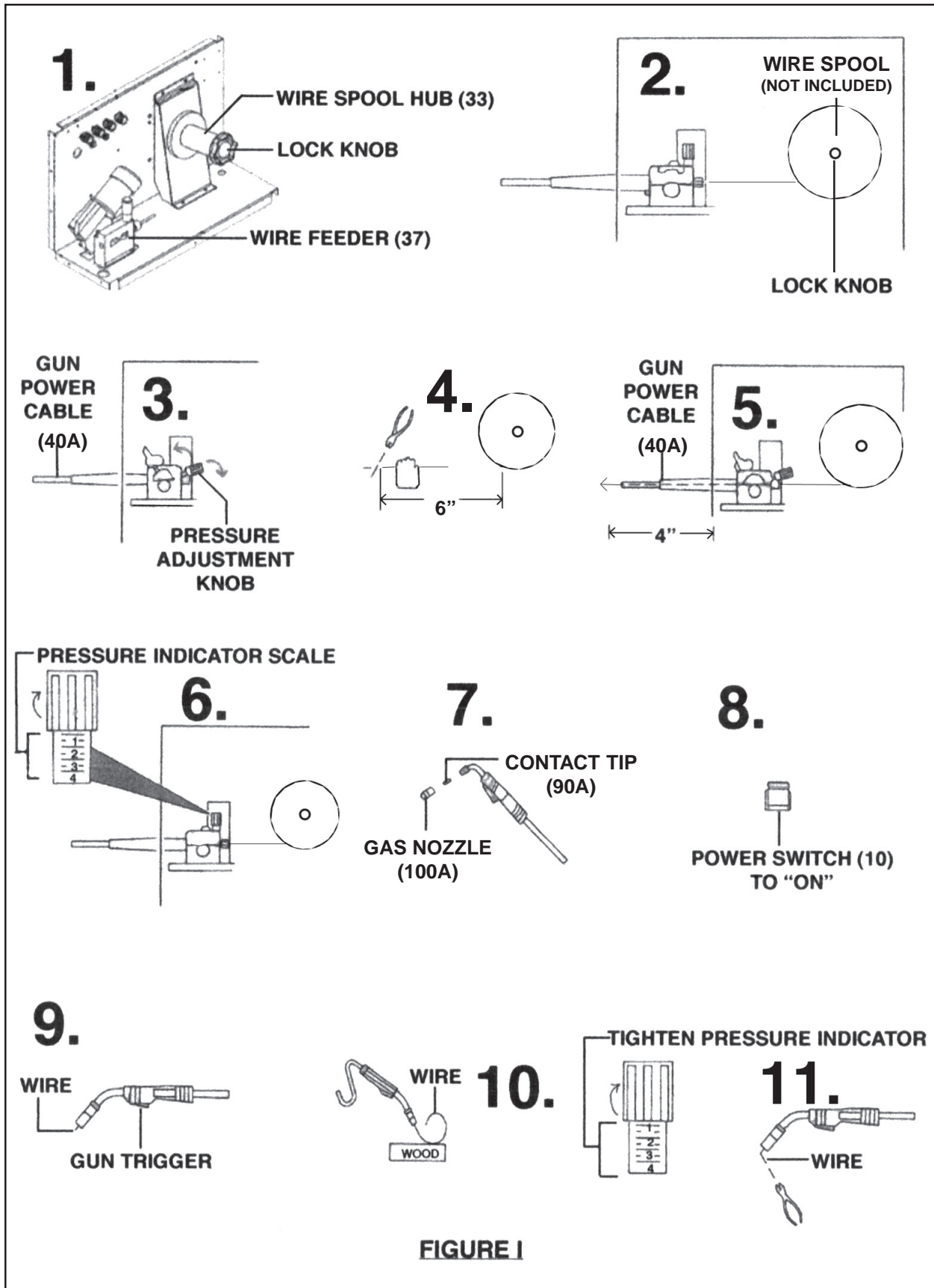



FIGURE I

6. Turn the Pressure Adjustment Knob *clockwise* to tighten the tension of the welding wire. **NOTE:** Use the Pressure Indicator Scale to set the desired drive roll pressure. **(See Figure I.)**
7. Remove the Gas Nozzle (100A) and Contact Tip (90A). **(See Figure I.)**
8. Turn the Power Switch (10) to its “**ON**” position. **(See Figure I.)**
9. Depress the Inching Button (36A) until the welding wire extends about 1” out of the Gun. Then, reinstall the Gas Nozzle (100A) and Contact Tip (90A). **(See Figures F and I.)**
10. Feed the welding wire out of the Gun to check for proper drive roll pressure. If necessary, tighten the Pressure Adjustment Knob to prevent the wire from slipping. **(See Figure I.)**
11. Cut off the welding wire so that only about 3/8” extends from the Gun. Then close the Upper Right Side Panel (21) of the welding machine and turn the Power Switch (10) to its “**OFF**” position. **(See Figure I.)**

To Install A Gas Cylinder:

1.  **CAUTION!** Using an oversized gas cylinder can cause tipping, resulting in cylinder and equipment damage and personal injury. Do not exceed maximum cylinder weight of 100 pounds.
2.  **CAUTION!** Do not use the Argon/Mixed Pressure Regulator/Flow Meter (43) with CO₂ shielding gas. To use CO₂ shielding gas, you must install a CO₂ gas Pressure Regulator/Flow Meter (not included).
3. With assistance, set the cylinder upright on the Base (19) of the Welder. Make sure to use the accessory Chain to secure the cylinder to the body of the Welder. **(See Figure J, next page.)**
4. Remove the Cap from the cylinder. Stand to the side of the cylinder Valve, and open the Valve slightly to blow dust and dirt from the Valve. Then, close the Valve. **(See Figure J.)**
5. Make sure the Flow Adjust on the Pressure Regulator/Flow Meter (43) is turned off. Then, screw the Pressure Regulator/Flow Meter firmly onto the cylinder Valve. **(See Figure J.)**
6. Attach the Gas Hose (202A) from the Pressure Regulator/Flow Meter (43) to the Gas Inlet Valve (29) located on the Back Panel (30) of the Welding machine. **(See Figure J.)**

7. Adjust the flow rate of the gas by turning the Flow Adjust. The typical flow rate is 20 CFH (cubic feet per hour). Check the welding wire manufacturer's recommended flow rate. **(See Figure J.)**

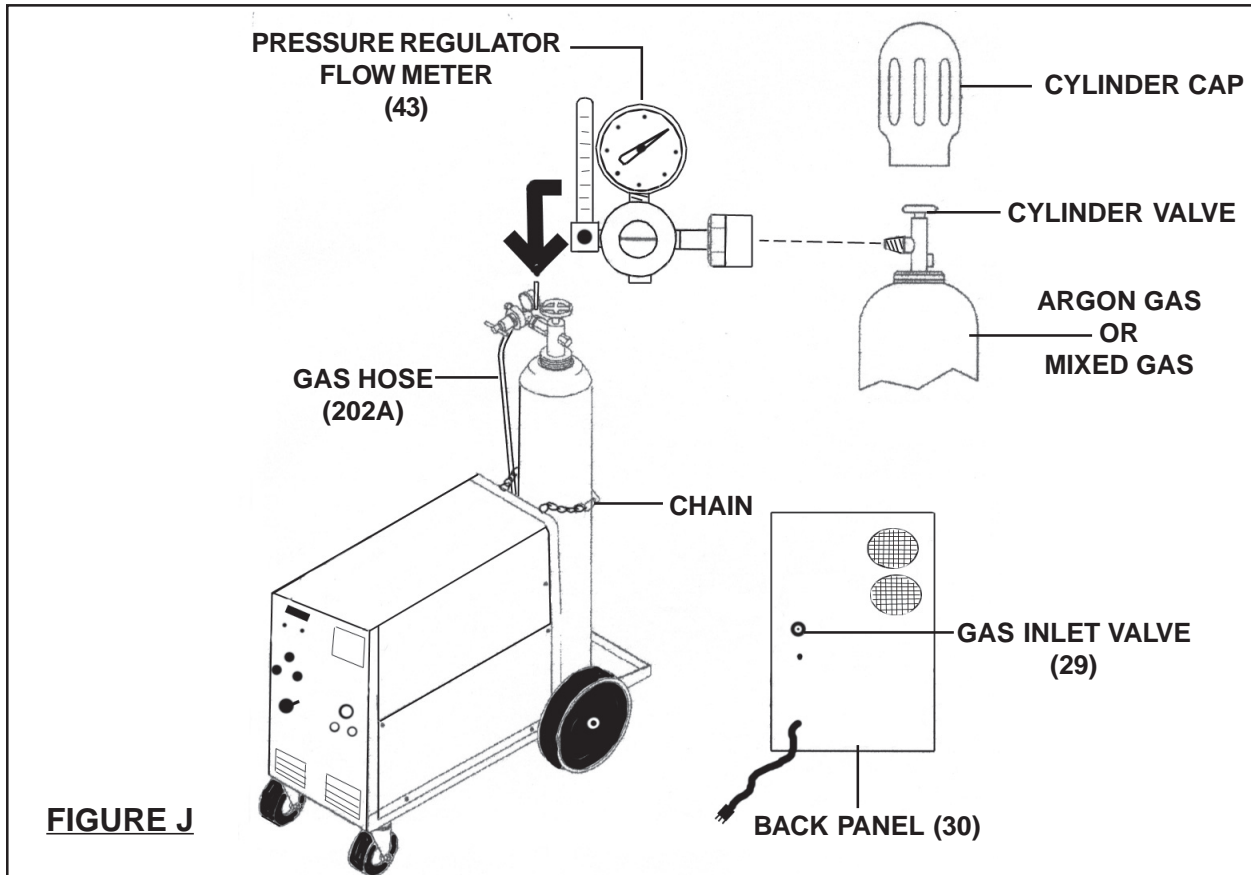

Welding Gun Duty Cycle And Overheating:

1. **IMPORTANT! Welding longer than the rated duty cycle for this Welding equipment can damage the Gun and void its warranty.**
2. Duty cycle is a percentage of 10 minutes that the unit can weld at its rated load without overheating. **(See Figure L, page 20.)**
3. If the unit should overheat, the thermostat opens, output stops, and the cooling fans continue to run. Wait fifteen minutes for the unit to cool. Reduce amperage or voltage, or duty cycle, before welding.
4. This Welder, at its **60%** duty cycle, can run continuously under load for **6** minutes out of each **10** minute period. **(See Figure L.)**
5. **NOTE:** Higher duty cycles can be used at lower currents. **(See Rating Plate information on Front Panel.)**

The Four Welding Features:

NOTE: The following four welding features are designed to optimize specific welding processes. (See Figure K.)

1. **2-TIME:** Typically, the standard welding process used. To operate, turn the Wire Speed Mode Selector (6) to its 2-Time setting. Squeeze the Welding Gun Trigger (18A) to start the Pre-Gas. Then, weld accordingly. Release the Welding Gun Trigger to stop welding. The Post-Gas will continue to deliver the protective gas according to the setting of the Post-Gas Timer (5D). (See Figures D, F, and K.)
2. **4-TIME:** The benefit of this process is that there is no need to continuously squeeze the Welding Gun Trigger (18A) during a long welding job. To operate, turn the Wire Speed Mode Selector (6) to its 4-Time setting. Squeeze and quickly release the Welding Gun Trigger to start and stop welding. The Post-Gas will continue to deliver the protective gas according to the setting of the Post-Gas Timer (5D). (See Figures D, F, and K.)
3. **SPOT AND PAUSE:** This process reduces the number of times the operator must squeeze the Welding Gun Trigger (18A) while spot welding. This process also allows the operator to lower the welding heat for thin material to avoid burn-through. To operate, turn the Wire Speed Mode Selector (6) to its Spot and Pause setting. By squeezing the Welding Gun Trigger (18A), the operator can weld and pause in cycle according to the settings of the Pause Timer (5A) and Spot Timer (5B). (See Figures D, F, and K.)
4. **INTERVAL:** This process allows the operator to produce the same length and quality of the welding bead more efficiently. To operate, turn the Wire Speed Mode Selector (6) to its Interval setting. By squeezing the Welding Gun Trigger (18A), the operator can weld in one cycle according to the preset welding time. (See Figures D, F, and K.)

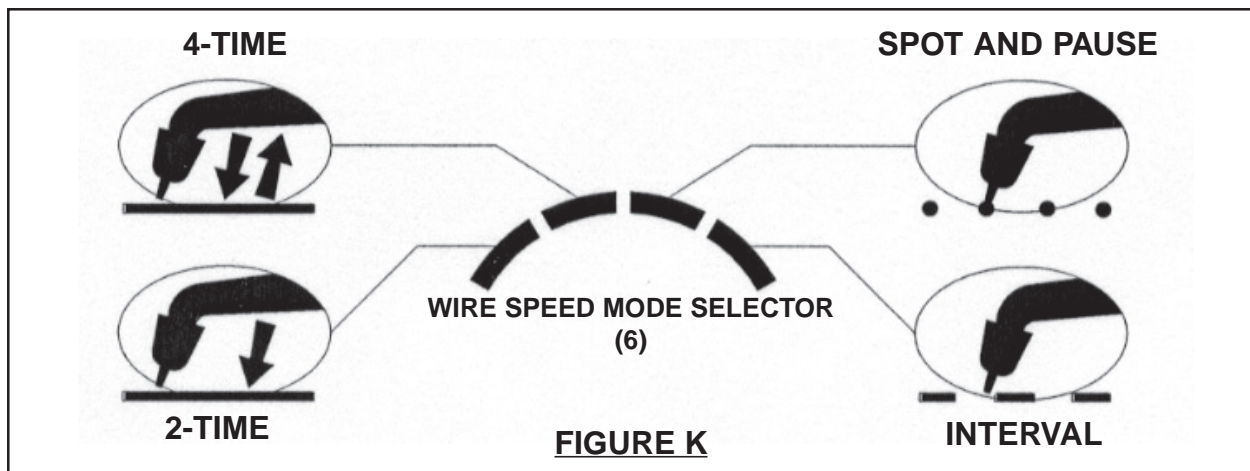

**.024" to .047" Hard or Flux Cored Wires
60% Duty Cycle at 250 Amperes Using Mixed Gases**

6 Minutes Welding

4 Minutes Resting

Relation Between Duty Cycle And Weld Amperes.

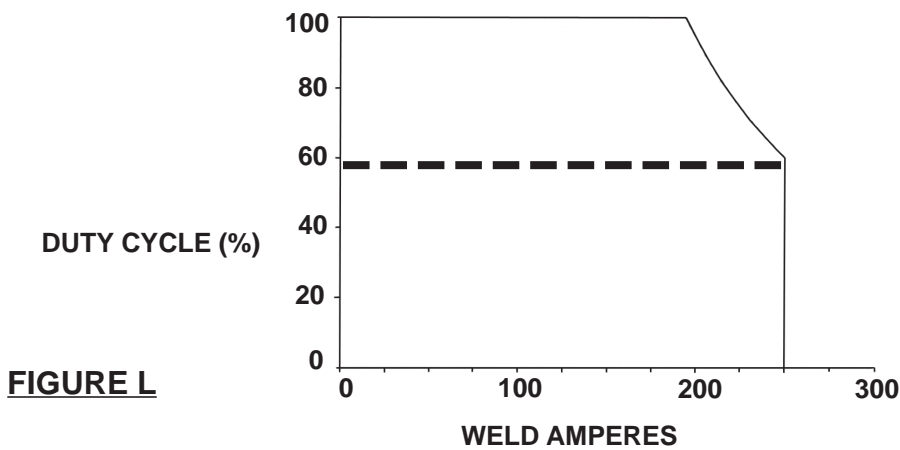

FIGURE L

Relation Between Thickness, Diameter Of Wire, Wire Speed, Voltage, & Current*:

Material Thickness (mm)	Wire Feed Speed (m/min)		Voltage (V)				Welding Current (A)
	0.9 mm	1.2 mm	CO ₂	75 Ar-25 CO ₂	Ar	98 Ar-2 O ₂	
0.9	2.5 ~ 3.0		18	16			50 ~ 60
1.2	3.5 ~ 4.0	1.5 ~ 1.8	19	17			70 ~ 80
1.5	4.5 ~ 5.5	2.2 ~ 2.8	20	17.7			90 ~ 110
2.0	6.0 ~ 6.6	3.0 ~ 3.3	20.7	18	20		120 ~ 130
3.0	7.0 ~ 7.6	3.5 ~ 3.8	21.5	18.5	20.5		140 ~ 150
4.7	8.0 ~ 8.6	4.0 ~ 4.5	22	19	21.5	23.5	160 ~ 170
6.4	9.0 ~ 9.6	4.7 ~ 5.0	22.7	19.5	22.5	24.5	180 ~ 190
8.0	10.0 ~ 10.6	5.3 ~ 5.6	23.5	20.5	23.5	25	200 ~ 210
9.5	10.6 ~ 13.2	5.6 ~ 6.9	25	22	25	26.5	220 ~ 250
12.0 and up		9.5	28	26	29	31	300

FIGURE M

***Do not change voltage while welding. Wire speed is a starting value only, and can be adjusted while welding. Weld conditions also depend on other variables such as stickout, travel speed, weld angle, cleanliness of metal, etc.**

Relation Between Wire Feed Speed, Size Of Wire, & Welding Current:

Wire Feed Speed (m/min)	Welding Current (A)			
	0.8 mm	0.9 mm	1.2 mm	1.6 mm
2.5	40	65	120	190
5.0	80	120	200	330
7.6	130	170	260	425
10.2	160	210	320	490
12.7	180	245	365	
15.2	200	265	400	
17.8	215	280	430	

FIGURE N

TROUBLESHOOTING GUIDE - WELDING MACHINE

Trouble	Causes	Corrective Action
Welder does not operate.	Line switch not turned "On".	Place line switch in "On" position.
	Supply line fuse blown.	Replace. (Also find the cause.)
	Power circuit dead.	Check supply line voltage.
	Broken Power lead.	Repair.
	Wrong voltage.	Check voltage against rating plate.
Welder welds, but soon stops welding.	Torch or work lead loose or broken.	Tighten and repair connections.
	Proper ventilation hindered.	Make sure all case openings are free for proper circulation of air.
	Welder loaded beyond rating.	Operate at normal current and duty cycle consistent with rating.
	Fan motor inoperative.	Check leads and motor bearings. Fan motor can be tested on 220V line; with welder on, voltage across fan motor should be approximately 220V.
	Poor internal connections.	Check for loose or hot connections and tighten.
Variable or sluggish welding	Excessive dust accumulation in welder.	Blow out welder with low pressure.
	Poor terminal connection.	Check and clean all connections.
	Current too low.	Check recommended currents, wire type and size.
	Low line voltage	Check the input line to be as specified on the nameplate. Check with power company.
	Welding leads too small.	Use larger welding leads.
Too many spatters	Old and badly frayed welding cables.	Replace.
	Insufficient gas.	Increase gas flow.
	Loose gas fittings on regulator or gas line.	Check and secure gas fittings.
	Voltage is too high.	Decrease the welding voltage.
	Torch is too inclined.	Correct the torch angle.
Poor penetration.	Nozzle is dirty.	Clean the nozzle.
	Inductance is not sufficient.	Correct the inductance.
	Current too low.	Increase welding current.
	Wire feed is not constant.	Correct the wire feeding.
	Edges are too far apart.	Correct the distance between the edges.
Porosity	Chamfer is too small.	Correct the chamfer.
	Projection is too far out.	Correct the projection.
	Dirt on welding metal or work piece.	Clean the work piece and welding metal.
Hot cracks	Protection gas impure or high humidity in gas.	Change the gas.
	Current intensity is too low.	Increase the current.
	Dirt on welding metal or work piece.	Clean the work piece and welding metal.
	Impure weld material.	Consult the wire supplier.
Welder won't shut off.	High heat supply.	Decrease the current.
	Type of wire is inappropriate.	Change the appropriate wire.
	Line switch has failed mechanically.	Clean on, Replace switch.

TROUBLESHOOTING GUIDE - WELDING GUN & WIRE DRIVE

Problem	Possible Cause
No arc.	<ol style="list-style-type: none"> 1. Interruption of welding power circuit to welding gun or workpiece. 2. Power source or control defective. 3. Trigger wire broken, cut, or disconnected. 4. Power source contractor not activated.
Arc between gas nozzle and workpiece.	<ol style="list-style-type: none"> 1. Spatter build-up inside gas nozzle.
Welding gun body or power cable overheated.	<ol style="list-style-type: none"> 1. Welding current too high. 2. Contact tip not correctly tightened. 3. Ground clamp making poor contact.
Welding wire melted onto contact tip.	<ol style="list-style-type: none"> 4. Wire feed starts too late (burn-back). 5. Wire jammed in liner due to dirt accumulation in liner or extreme bending of cable assembly. 6. Feed rate too low. 7. Contact tip too far away from workpiece. 8. Burn-back time set too long.
Irregular wire feed.	<ol style="list-style-type: none"> 9. Drive roll pressure too low or too high. 10. Faulty or worn liner. 11. Incorrect type or size of liner, or liner incorrectly attached. 12. Faulty wire feed control. 13. Drive rolls worn or incorrectly installed. Incorrect Size of drive rolls used.

INSPECTION, MAINTENANCE, AND CLEANING - WELDING MACHINE

1. **WARNING!** Make sure the Power Switch (10) is in its “OFF” position. Unplug the Power Cord Plug from its electrical outlet, and allow the Welder to completely cool before performing any inspection, maintenance, or cleaning procedures. **Note:** Always ground the contact tip to insure that there is no residual energy in the Welder.

2. **Before each use**, inspect the general condition of the Welder. Check for damaged electrical wiring, loose connections, cracked, burnt, or broken parts, and any other condition that may affect its safe operation. If abnormal noise or vibration occurs, have the problem corrected before further use.
Do not use damaged equipment.

3. **Every six months:** Blow off or vacuum dirt and dust deposits on the Auxiliary Transformer (23) and other components. Dirt or dust deposits on the Welding Transformer and other internal components may reduce the insulating property or cause overheated Transformer. **During heavy usage, clean monthly.**

4. **To replace the 3 AMP Buss Fuse:** Failure of the Welder to operate may be caused by a blown 3 AMP Fuse (7) as indicated by its melted wire strand within the Fuse. To replace the Fuse, unscrew and remove the Fuse Cap. Remove the old Fuse, and install a new 3 AMP Fuse. Then, replace the Fuse Cap.
5. **When storing,** make sure to store the Welder in a safe, clean, dry location out of reach of children and unauthorized users.
6.  **CAUTION!** All maintenance, service, and repairs not listed in this manual are only to be attempted by a qualified service technician.

INSPECTION, MAINTENANCE, AND CLEANING - WELDING GUN

1.  **WARNING!** Make sure the Power Switch (10) on the Welding Machine is in its “OFF” position. Unplug the Power from its electrical outlet, and allow the Welder to completely cool before performing any inspection, maintenance, or cleaning procedures. **Note:** Always ground the contact tip to insure that there is no residual energy in the Welder.
2. **Before each use:** Inspect the general condition of the Welding Gun. Check for damaged electrical wiring/gas hose, loose connections, cracked, burnt, or broken parts, and any other condition that may affect its safe operation. If abnormal noise or vibration occurs, have the problem corrected before further use.
Do not use damaged equipment.
3. **Before each use:** Clean welding spatter from the inside of the Gas Nozzle (100A) and spray with an anti-spatter fluid.
4. **To replace the Gun Contact Tip:** Cut off the welding wire at the Contact Tip (90A). Remove the Nozzle. Remove the old Contact Tip, and install a new Contact Tip. Then, replace the Nozzle. **(See Figure O.)**

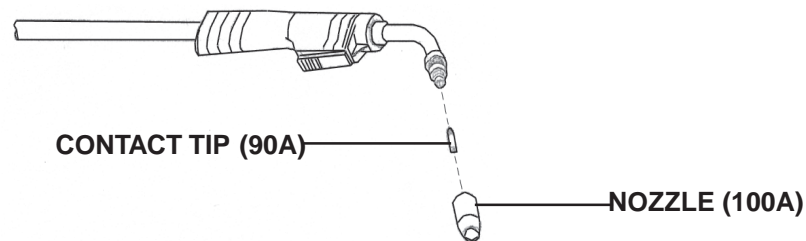
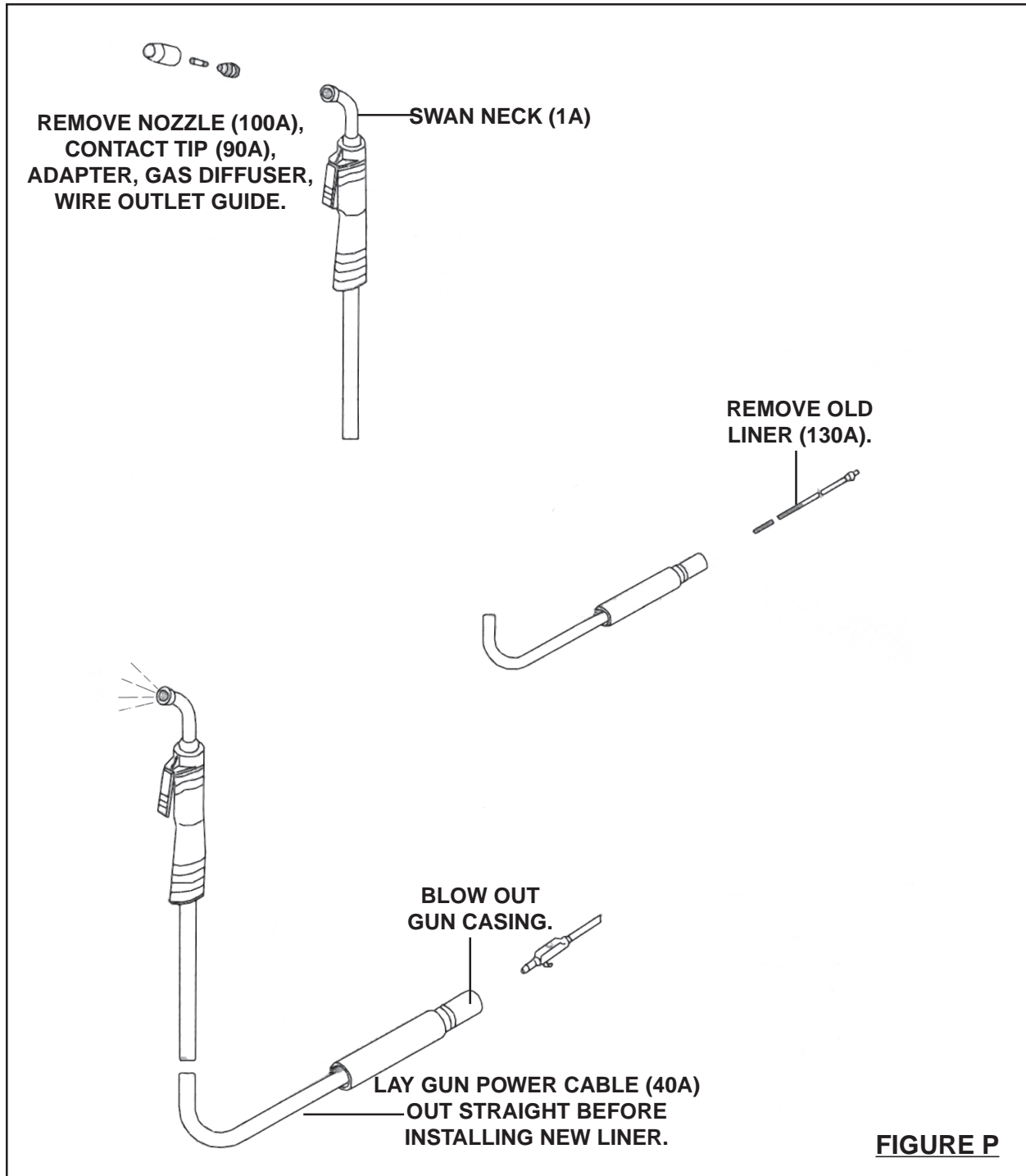



FIGURE O

5. **To replace the Gun Liner:** Disconnect the Gun's Power Cable from the Welding machine. Remove the Nozzle, Contact Tip, Adapter, Gas Diffuser, and Wire Outlet Guide. Then, remove the old Liner. Lay the Gun's Power Cable out straight before installing a new Liner. Blow out the Gun Casing with compressed air. Install and tighten the new Liner. Cut Liner off 3/4" from the Head Tube (3/8" for aluminum). Then reinstall the Wire Outlet Guide, Gas Diffuser, Adapter, Contact Tip, and Nozzle. **(See Figure P.)**



6. **To clean exterior of Welding Gun:** Use a damp cloth with a mild detergent. Then, dry. **Do not use solvents to clean the Gun.**
7. **When storing:** Make sure to store the Welding Gun in a safe, clean, and dry location out of reach of children and unauthorized users.
8.  **WARNING!** All maintenance, service, and repairs not listed in this manual are only to be attempted by a qualified service technician.

PLEASE READ THE FOLLOWING CAREFULLY

THE MANUFACTURER AND/OR DISTRIBUTOR HAS PROVIDED THE PARTS LIST AND ASSEMBLY DIAGRAM IN THIS MANUAL AS A REFERENCE TOOL ONLY. NEITHER THE MANUFACTURER OR DISTRIBUTOR MAKES ANY REPRESENTATION OR WARRANTY OF ANY KIND TO THE BUYER THAT HE OR SHE IS QUALIFIED TO MAKE ANY REPAIRS TO THE PRODUCT, OR THAT HE OR SHE IS QUALIFIED TO REPLACE ANY PARTS OF THE PRODUCT. IN FACT, THE MANUFACTURER AND/OR DISTRIBUTOR EXPRESSLY STATES THAT ALL REPAIRS AND PARTS REPLACEMENTS SHOULD BE UNDERTAKEN BY CERTIFIED AND LICENSED TECHNICIANS, AND NOT BY THE BUYER. THE BUYER ASSUMES ALL RISK AND LIABILITY ARISING OUT OF HIS OR HER REPAIRS TO THE ORIGINAL PRODUCT OR REPLACEMENT PARTS THERETO, OR ARISING OUT OF HIS OR HER INSTALLATION OF REPLACEMENT PARTS THERETO.

PARTS LIST - WELDING MACHINE

Part #	Description	Part #	Description	Part #	Description
1	Front Panel	12	Digital Volt/AMP Display	31	Cylinder Support
2	MIG Gun Outlet	13	Front Panel Bracket	32	Fan
3A	High Inductance Outlet	14	Digital Wire Feed Speed Display	33	Wire Spool Hub
3B	Low Inductance Outlet	15	Welding Transformer	34	Wire Spool Support
4	Voltage Selector Knob	16	Magnetic Contractor	35	Bypass PCB
4A	Voltage Selector Switch	17	8-Pin Relay	36A	Inching Button
5A	Pause Timer	18	8-Pin Relay Socket	36B	Gas Test Button
5B	Spot Timer	19	Base	37	Wire Feeder
5C	Wire Speed Potentiometer	20	Lower Right Side Panel	38	Rectifier
5D	Post-Gas Timer	21	Upper Right Side Panel	39	Partition
5E	Burn Back Timer	22	Input Terminal	40	Capacitor
5F	Soft Start Potentiometer	23	Auxiliary Transformer	41	Wire Speed PCB
5G	Pre-Gas Timer	24	Choke	42	Left Side Panel
6	Wire Speed Mode Selector	25	Resistor	43	Pressure Regulator/ Flow Meter
7	Fuse	26	Partition	44	Cotter Pins
8	Overheating LED	28	Solenoid Valve	45	Bolts
9	Operating LED	29	Gas Inlet Valve	46	Washers
10	Power Switch	30	Back Panel	47	Rear Wheels
11	Handle			48	Front Castor Wheels

ASSEMBLY DIAGRAM - WELDING MACHINE

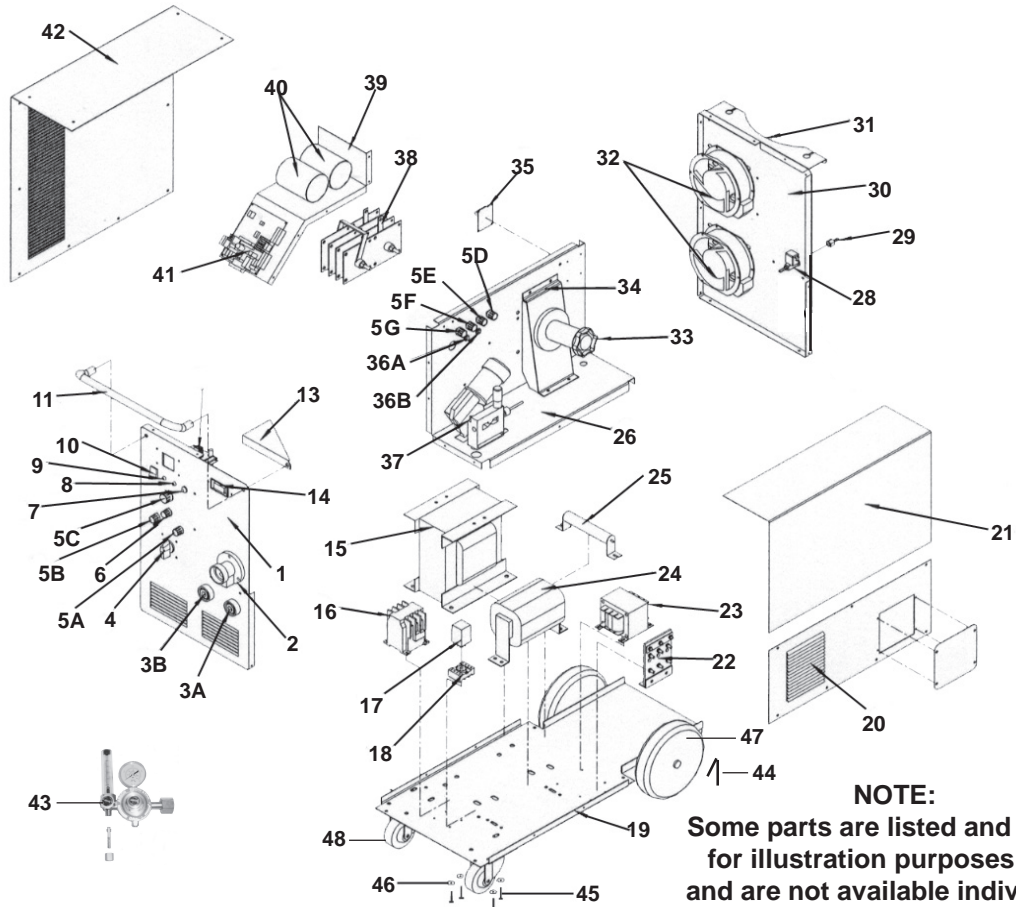

PARTS LIST - WELDING GUN

Part #	Description	Part #	Description
1A	Swan Neck (MB 25 AK, 50° Bent)	58A	Adapter Nut
4A	Nozzle Spring	59A	Central Adapter Block (KZ-2)
6A	Gun Body, Brass	60A	Nut (M10 x 1)
7A	Gun Body, Plastic	61A	O-Ring (4 x 1)
10A	Ergonomic Handle	62A	Trigger Wire Connector (female)
18A	Trigger	80A	Contact Tip Holder (M6, 35.0 mm)
40A	Power Cable (4.00 m)	90A	Contact Tip (Qty. 5)
40.1A	Hex Nut (M10 x 1)	100A	Gas Nozzle
44A	Trigger Wire Connector	120A	Insulated Liner
45A	Insulating Sleeve	130A	Teflon© Core Liner
46A	Trigger Wire Connector (Male)	131A	Core Liner Collet
54A	Cable Support Spring (NW 19)	132A	O-Ring (3.5 x 1.5)
56A	Cable Support Machine Side	133A	Core Liner Guide Tube
57A	Screw (M4 x 6)	200A	Spanner
57.1A	Cover Cap (1)	201A	Ground Clamp Cable
-----	-----	202A	Gas Hose

ASSEMBLY DIAGRAM - WELDING GUN

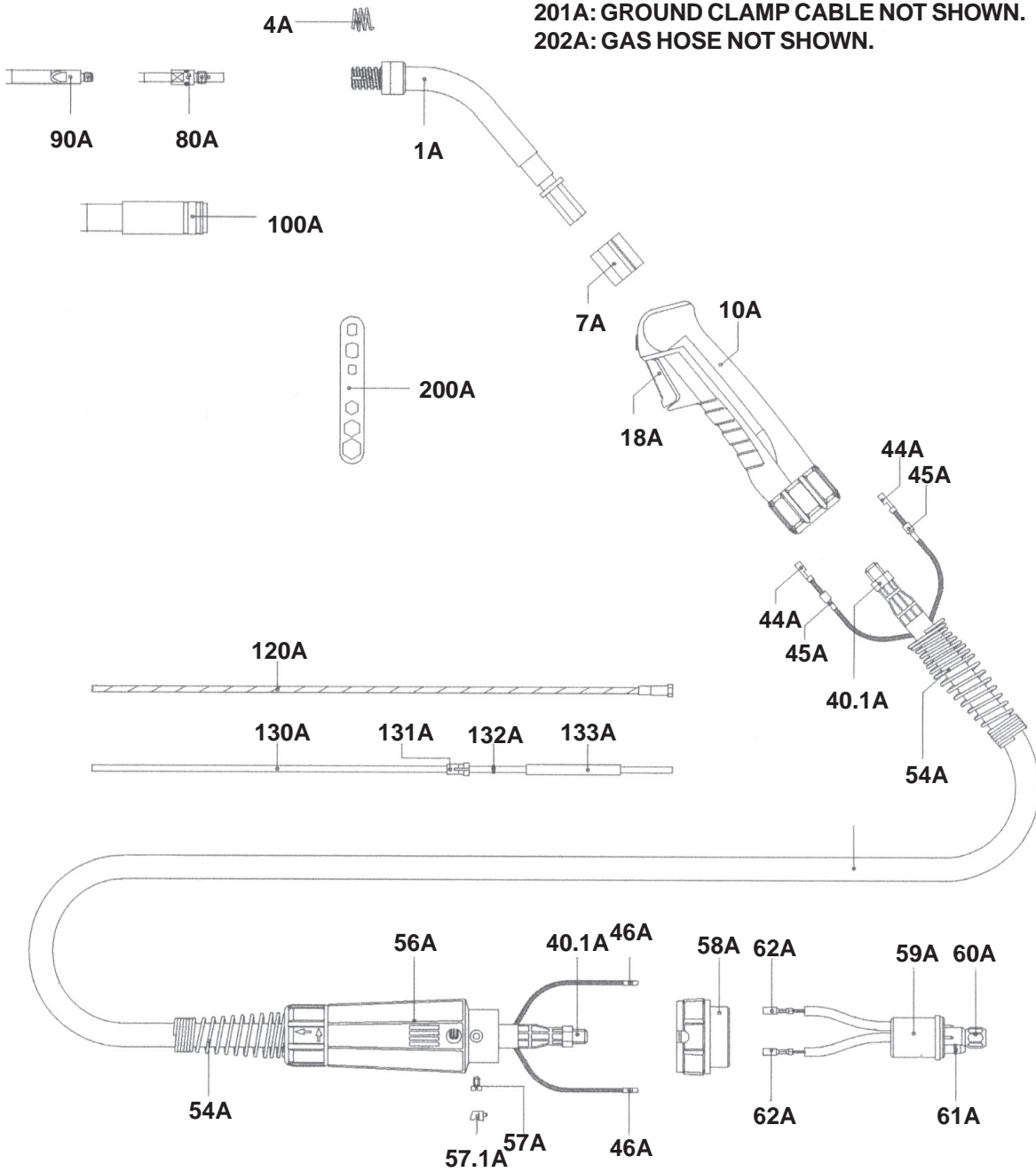

NOTE:
Some parts are listed and shown
for illustration purposes only,
and are not available individually
as replacement parts.

ELECTRICAL SCHEMATIC - WELDING MACHINE

