

# Reebok V 4500

Patent Pending

Model No. RBTL15830

Serial No. \_\_\_\_\_

Write the serial number in the space above for future reference.

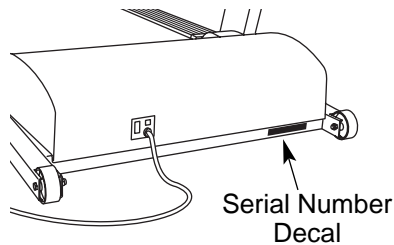

## USER'S MANUAL

### QUESTIONS?

If you have questions, or if there are missing or damaged parts, we will guarantee complete satisfaction through direct assistance from our factory.

TO AVOID UNNECESSARY DELAYS, PLEASE CALL DIRECT TO OUR TOLL-FREE CUSTOMER HOT LINE. The trained technicians on our Customer Hot Line will provide immediate assistance, free of charge to you.

CUSTOMER HOT LINE:

**1-800-999-3756**

Mon.-Fri., 6 a.m.-6 p.m. MST

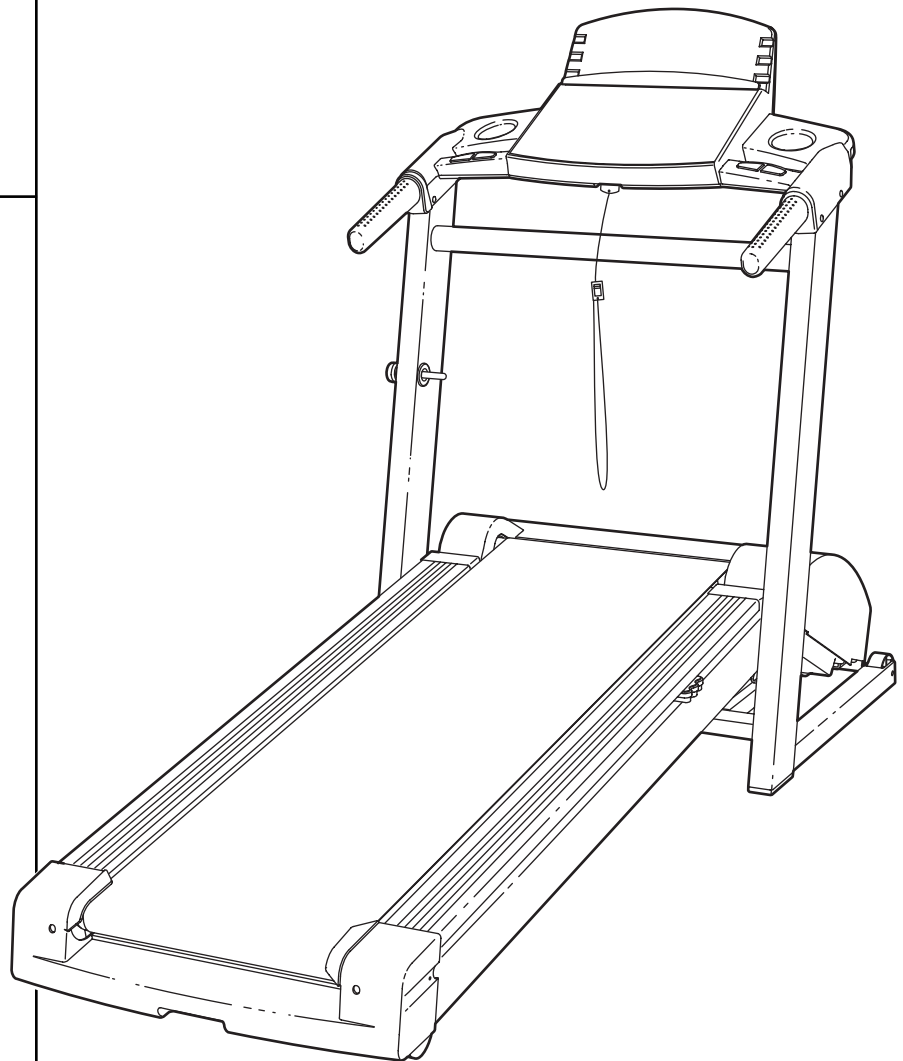

### CAUTION

Read all precautions and instructions in this manual before using this equipment. Save this manual for future reference.



Visit our website at

[www.reebokhomefitness.com](http://www.reebokhomefitness.com)

*new products, prizes,  
fitness tips, and much more!*

# Reebok V 4500

## TABLE OF CONTENTS

IMPORTANT PRECAUTIONS .....	3
BEFORE YOU BEGIN .....	5
HOW TO SET UP THE TREADMILL .....	6
HOW TO USE THE HEART RATE MONITOR .....	7
TREADMILL OPERATION .....	9
HOW TO FOLD AND MOVE THE TREADMILL .....	27
TROUBLESHOOTING .....	28
REEBOK UNIVERSITY .....	31
EXERCISE GUIDELINES .....	33
PART LIST .....	34
HOW TO ORDER REPLACEMENT PARTS .....	35
LIMITED WARRANTY .....	Back Cover

Note: An EXPLODED DRAWING is attached in the center of this manual.

# IMPORTANT PRECAUTIONS

**⚠ WARNING:** To reduce the risk of burns, fire, electric shock, or injury to persons, read the following important precautions and information before operating the treadmill.

1. It is the responsibility of the owner to ensure that all users of this treadmill are adequately informed of all warnings and precautions.
2. Use the treadmill only as described in this manual.
3. Place the treadmill on a level surface, with at least eight feet of clearance behind it and two feet on each side. Do not place the treadmill on any surface that blocks air openings. To protect the floor or carpet from damage, place a mat under the treadmill.
4. Keep the treadmill indoors, away from moisture and dust. Do not put the treadmill in a garage or covered patio, or near water.
5. Do not operate the treadmill where aerosol products are used or where oxygen is being administered.
6. Keep children under the age of 12 and pets away from the treadmill at all times.
7. The treadmill should not be used by persons weighing more than 300 pounds.
8. Never allow more than one person on the treadmill at a time.
9. Wear appropriate exercise clothes when using the treadmill. Do not wear loose clothes that could become caught in the treadmill. Athletic support clothes are recommended for both men and women. *Always wear athletic shoes. Never use the treadmill with bare feet, wearing only stockings, or in sandals.*
10. When connecting the power cord (see page 9), plug the power cord into a surge suppressor (not included) and plug the surge suppressor into a grounded circuit capable of carrying 15 or more amps. No other appliance should be on the same circuit. Do not use an extension cord.
11. Use only a single-outlet surge suppressor that meets all of the specifications described on page 9. To purchase a surge suppressor, see your local REEBOK dealer or call 1-800-806-3651 and order part number 146148.
12. Failure to use a properly functioning surge suppressor could result in damage to the control system of the treadmill. If the control system is damaged, the walking belt may change speed or stop unexpectedly, which may result in a fall and serious injury.
13. Keep the power cord and the surge suppressor protector away from heated surfaces.
14. Never move the walking belt while the power is turned off. Do not operate the treadmill if the power cord or plug is damaged, or if the treadmill is not working properly. (See **BEFORE YOU BEGIN** on page 5 if the treadmill is not working properly.)
15. Never start the treadmill while you are standing on the walking belt. Always hold the handrails while using the treadmill.
16. The treadmill is capable of high speeds. Adjust the speed in small increments to avoid sudden jumps in speed.
17. To reduce the possibility of the treadmill overheating, do not operate the treadmill continuously for longer than one hour.
18. The heart rate monitor is not a medical device. Various factors, including the user's movement, may affect the accuracy of heart rate readings. The heart rate monitor is intended only as an exercise aid in determining heart rate trends in general.
19. Never leave the treadmill unattended while it is running. Always remove the key, unplug the power cord, and switch the reset/off circuit breaker to the off position when the treadmill is not in use. (See the drawing on page 5 for the location of the circuit breaker.)
20. Do not raise, lower, or move the treadmill until it is properly set up. (See **HOW TO SET UP THE TREADMILL** on page 6 and **HOW TO FOLD AND MOVE THE TREADMILL** on page 27.) You must be able to safely lift 45 pounds (20 kg) to raise, lower, or move the treadmill.
21. Do not change the incline of the treadmill by placing objects under the treadmill.

22. When folding or moving the treadmill, make sure that the storage latch is fully closed.

23. Inspect and properly tighten all parts of the treadmill regularly.

24. When using iFIT.com CDs and videos, an electronic “chirping” sound will alert you when the speed and/or incline of the treadmill is about to change. Always listen for the “chirp” and be prepared for speed and/or incline changes. In some instances, the speed and/or incline may change before the personal trainer describes the change.

25. When using iFIT.com CDs and videos, you can manually override the speed and incline settings by pressing the speed and incline buttons. However, when the next “chirp” is heard, the speed and/or incline will change to the next settings of the CD or video program.

26. Always remove iFIT.com CDs and videos from your CD player or VCR when you are not using them.

27. Never drop or insert any object into any opening.

28. This treadmill is intended for home use only. Do not use this treadmill in any commercial, rental, or institutional setting.

29. **DANGER:** Always unplug the power cord immediately after use, before cleaning the treadmill, and before performing the maintenance and adjustment procedures described in this manual. Never remove the motor hood unless instructed to do so by an authorized service representative. Servicing other than the procedures in this manual should be performed by an authorized service representative only.

**! WARNING:** Before beginning this or any exercise program, consult your physician. This is especially important for persons over the age of 35 or persons with pre-existing health problems. Read all instructions before using. ICON assumes no responsibility for personal injury or property damage sustained by or through the use of this product.

## SAVE THESE INSTRUCTIONS

The decals shown here have been placed on the treadmill. If a decal is missing, or if it is not legible, please call our Customer Service Department, toll-free, to order a free replacement decal (see HOW TO ORDER REPLACEMENT PARTS on page 35 of this manual). Apply the decal in the location shown. Note: The decals are not shown at actual size.

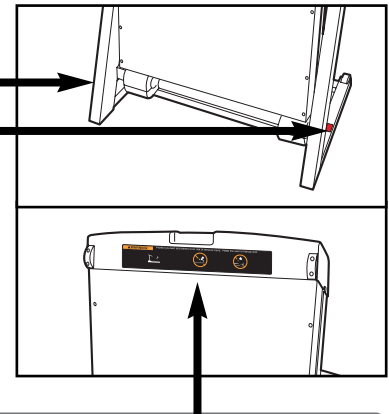

**! WARNING:** Protect yourself and others from risk of serious injury. Read the user's manual and:

- Fully engage storage latch before treadmill is moved or stored.
- Reduce incline to lowest level before folding treadmill into storage position.



- Stand only on side rails when starting or stopping treadmill.
- Change speed in small increments.
- Hold handrails to prevent falling, and always wear the safety clip while operating treadmill.
- Stop if you feel faint, dizzy, or short of breath.



- Never allow children on or around treadmill.
- Remove key when not in use.



- Keep clothing, fingers, and hair away from moving belt.
- Never try to adjust or fix the belt while it is moving.
- Always wear athletic shoes while operating treadmill.

# BEFORE YOU BEGIN

Thank you for selecting the new REEBOK® V 4500 treadmill. The V 4500 treadmill combines advanced technology with innovative design to let you enjoy an excellent form of cardiovascular exercise in the convenience and privacy of your home. And when you're not exercising, the unique V 4500 can be folded up, requiring less than half the floor space of other treadmills.

**For your benefit, read this manual carefully before using the treadmill.** If you have additional questions, please call our Customer Service Department toll-free

at 1-800-999-3756, Monday through Friday, 6 a.m. until 6 p.m. Mountain Time (excluding holidays). To help us assist you, please mention the product model number and serial number when calling. The model number is RBTL15830. The serial number can be found on a decal attached to the treadmill (see the front cover of this manual for the location).

Before reading further, please review the drawing below and familiarize yourself with the parts that are labeled.

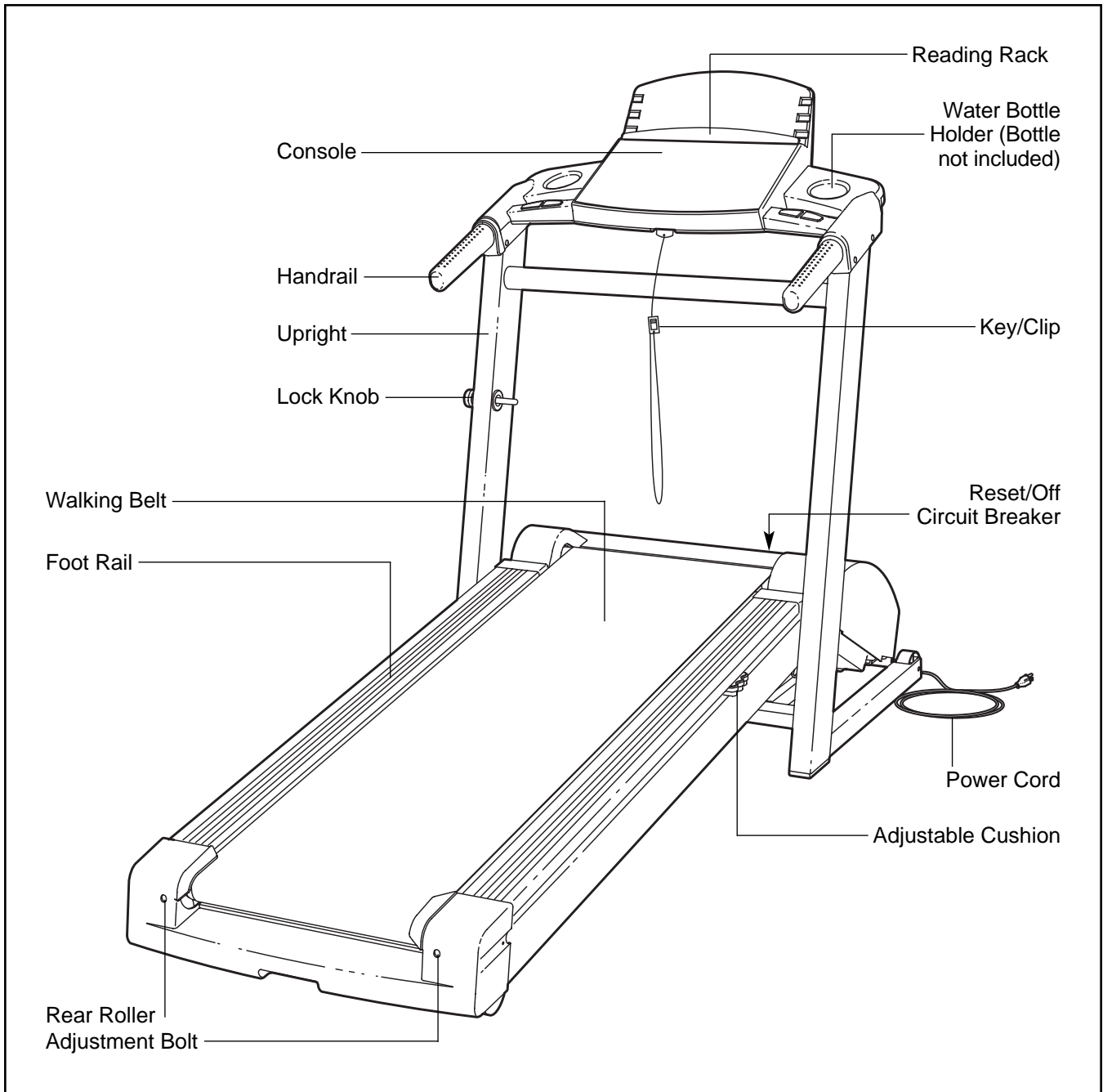

# HOW TO SET UP THE TREADMILL

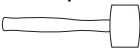
**Assembly requires two people.** Set the treadmill in a cleared area and remove all packing materials. Do not dispose of the packing materials until assembly is completed. **A rubber mallet**  **may be needed for assembly.**

Note: The underside of the treadmill walking belt is coated with high-performance lubricant. During shipping, a small amount of lubricant may be transferred to the top of the walking belt or the shipping carton. This is a normal condition and does not affect treadmill performance. If there is lubricant on top of the walking belt, simply wipe off the lubricant with a soft cloth and a mild, non-abrasive cleaner.

1. With the help of a second person, carefully raise the Uprights (65) until the treadmill is in the position shown.

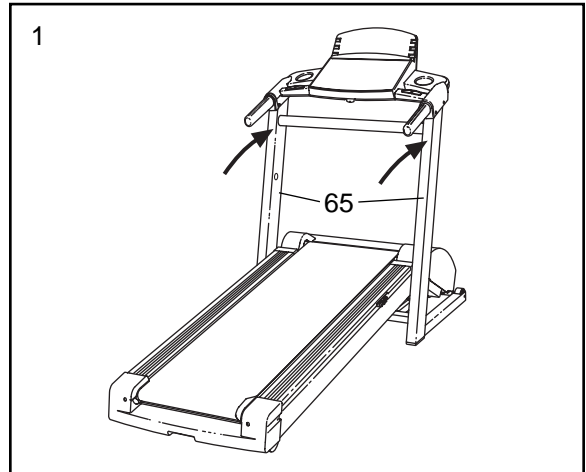

2. Press the Lock Knob Sleeve (68) into the left Upright (65). If necessary, use a rubber mallet to tap the Lock Knob Sleeve into the Upright.

Remove the Lock Knob (67) from the Lock Pin (72). Make sure that the Lock Pin Collar (70) and the Spring (69) are on the Lock Pin. (Note: If there are two Lock Pin Collars, place them on each side of the Spring.) Insert the Lock Pin into the left Upright (65) and tighten the Lock Knob onto the Lock Pin.

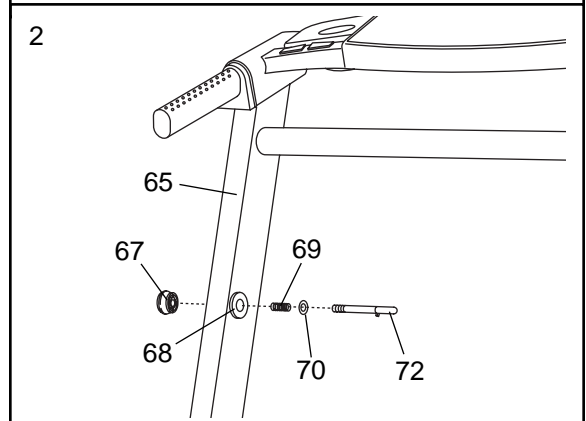

3. **Make sure that all parts are tightened before you use the treadmill.** Keep the included allen wrench in a secure place. The allen wrench is used to adjust the walking belt (see pages 28 and 29). To protect the floor or carpet from damage, place a mat under the treadmill.

## HOW TO ADJUST THE CUSHIONING SYSTEM

The treadmill features a cushioning system that reduces the impact as you walk or run on the treadmill. The firmness of the cushioning system is controlled by the adjustable cushions at the center of the treadmill (there is one adjustable cushion on each side). To select the maximum firmness setting, turn the cushions to level 3; to decrease the firmness, turn the cushions to level 2 or 1. Note: It may be helpful to lift on the walking platform as you rotate the cushion. **The faster you run on the treadmill, or the heavier your weight, the firmer the cushioning system should be. Make sure that both cushions are at the same setting.**

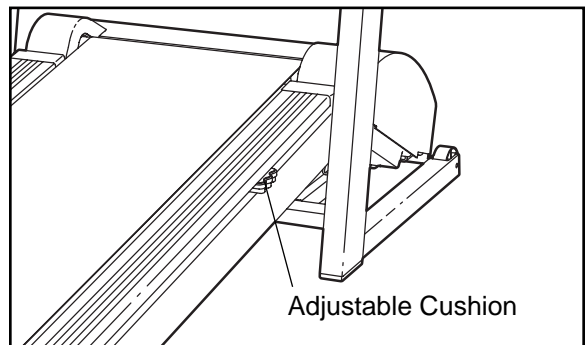

# HOW TO USE THE HEART RATE MONITOR

## HOW TO PUT ON THE HEART RATE MONITOR

Before you use the heart rate monitor, please read all instructions on this page and the following page.

The heart rate monitor consists of two components: the chest strap and the sensor unit.

See drawing 2 and attach the chest strap to the sensor unit. Insert one of the tabs on the chest strap through one end of the sensor unit. Make sure to press the end of the sensor unit under the buckle on the chest strap—the tab should be almost flush with the sensor unit.

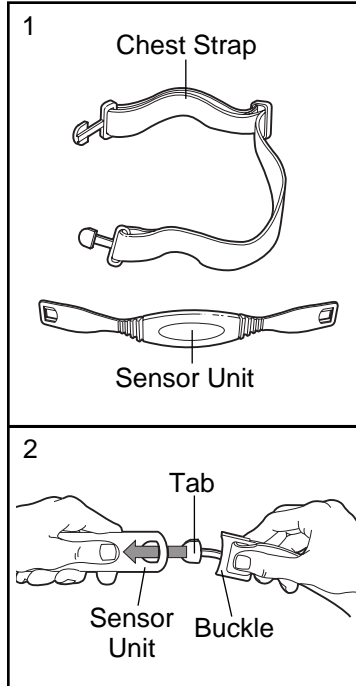

Next, wrap the heart rate monitor around your chest and attach the other end of the chest strap to the sensor unit. Adjust the length of the chest strap, if necessary.

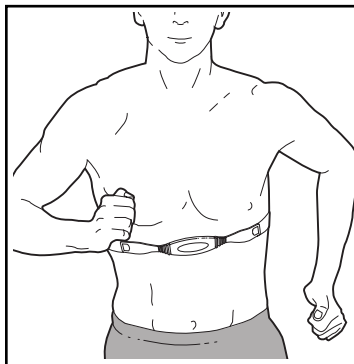

The heart rate monitor should be under your clothes, tight against your skin, and as high under the pectoral muscles or breasts as is comfortable. Make sure that the logo on the sensor unit is facing forward and is right-side-up.

Pull the sensor unit away from your body a few inches and locate the two electrode areas on the inner side. The electrode areas are the areas covered by shallow ridges. Using saline solution such as saliva or contact lens solution, wet both electrode areas. Return the sensor unit to a position against your chest.

## HEART RATE MONITOR CARE AND MAINTENANCE

- Thoroughly dry the heart rate monitor after each use. The heart rate monitor is activated when the electrode areas are wetted and the heart rate monitor is put on; the heart rate monitor shuts off when it is removed and the electrode areas are dried. If the heart rate monitor is not dried after each use, it may remain activated longer than necessary, draining the battery prematurely.
- Store the heart rate monitor in a warm, dry place. Do not store the heart rate monitor in a plastic bag or other container that may trap moisture.
- Do not expose the heart rate monitor to direct sunlight for extended periods of time.
- Do not expose the heart rate monitor to temperatures above 122° Fahrenheit (50° Celsius) or below 14° Fahrenheit (-10° Celsius).
- Do not excessively bend or stretch the sensor unit when using or storing the heart rate monitor.
- Clean the sensor unit periodically using a damp cloth; never use alcohol, abrasives, or chemicals. The chest strap may be hand washed and air dried.

## HEART RATE MONITOR TROUBLESHOOTING

The instructions on the following pages explain how the heart rate monitor is used with the console. If the letters “PLS” appear in the PULSE display or if the displayed heart rate is excessively high or low, try the steps below.

- Make sure that you are wearing the heart rate monitor exactly as described at the left. If the heart rate monitor does not function properly when positioned as described, move it slightly lower or higher on your chest.
- Use saline solution such as saliva or contact lens solution to wet the two electrode areas on the sensor unit. If heart rate readings do not appear until you begin perspiring, re-wet the electrode areas.
- As you walk or run on the treadmill, position yourself near the center of the walking belt. **For the console to display heart rate readings, the user must be within arm’s length of the console.**

- The heart rate monitor is designed to work with people who have normal heart rhythms. Heart rate reading problems may be caused by medical conditions such as premature ventricular contractions (pvc's), tachycardia bursts, and arrhythmia.
- The operation of the heart rate monitor can be affected by magnetic interference caused by high power lines or other sources. If it is suspected that this is a problem, try relocating the treadmill.
- The CR2032 battery may need to be replaced. Follow the steps at the right to replace the battery.

Locate the battery cover on the back of the sensor unit. Insert a coin into the slot in the cover and turn the cover counterclockwise to the "open" position. Remove the cover.

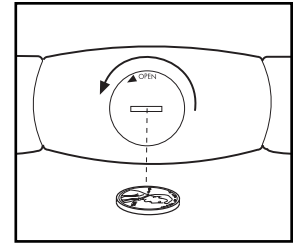

Remove the old battery from the sensor unit. Insert a new **CR 2032 battery**, making sure that the writing is on top. In addition, make sure that the rubber gasket is in place in the sensor unit. Replace the battery cover and turn it to the closed position.

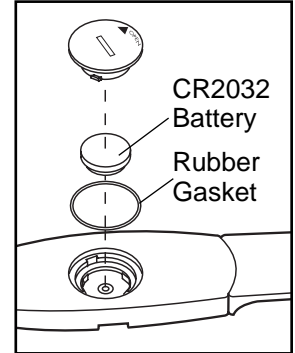



# TREADMILL OPERATION

## THE PERFORMANT LUBE™ WALKING BELT

Your treadmill features a walking belt coated with PERFORMANT LUBE™, a high-performance lubricant. **IMPORTANT: Never apply silicone spray or other substances to the walking belt or the walking platform. Such substances will deteriorate the walking belt and cause excessive wear.**

## HOW TO PLUG IN THE POWER CORD

**⚠ DANGER:** Improper connection of the equipment-grounding conductor can result in an increased risk of electric shock. Check with a qualified electrician or serviceman if you are in doubt as to whether the product is properly grounded. Do not modify the plug provided with the product—if it will not fit the outlet, have a proper outlet installed by a qualified electrician.

Your treadmill, like any other type of sophisticated electronic equipment, can be seriously damaged by sudden voltage changes in your home's power. Voltage surges, spikes, and noise interference can result from weather conditions or from other appliances being turned on or off. **To decrease the possibility of your treadmill being damaged, always use a surge suppressor with your treadmill (see drawing 1 at the right). To purchase a surge suppressor, see your local REEBOK dealer or call 1-800-806-3651 and order part number 146148.**

Use only a single-outlet surge suppressor that is UL 1449 listed as a transient voltage surge suppressor (TVSS). The surge suppressor must have a UL suppressed voltage rating of 400 volts or less and a minimum surge dissipation of 450 joules. The surge suppressor must be electrically rated for 120 volts AC and 15 amps. There must be a monitoring light on the surge suppressor to indicate whether it is functioning properly. Failure to use a properly functioning surge suppressor could result in damage to the control system of the treadmill. If the control system is damaged, the walking belt may change speed or stop unexpectedly, which may result in a fall and serious injury.

**This product must be grounded.** If it should malfunction or break down, grounding provides a path of least resistance for electric current to reduce the risk of electric shock. This product is equipped with a cord having

an equipment-grounding conductor and a grounding plug. **Plug the power cord into a surge suppressor, and plug the surge suppressor into an appropriate outlet that is properly installed and grounded in accordance with all local codes and ordinances. Important: The treadmill is not compatible with GFCI-equipped outlets.**

This product is for use on a nominal 120-volt circuit, and has a grounding plug that looks like the plug illustrated in drawing 1 below. A temporary adapter that looks like the adapter illustrated in drawing 2 may be used to connect the surge suppressor to a 2-pole receptacle as shown in drawing 2 if a properly grounded outlet is not available.

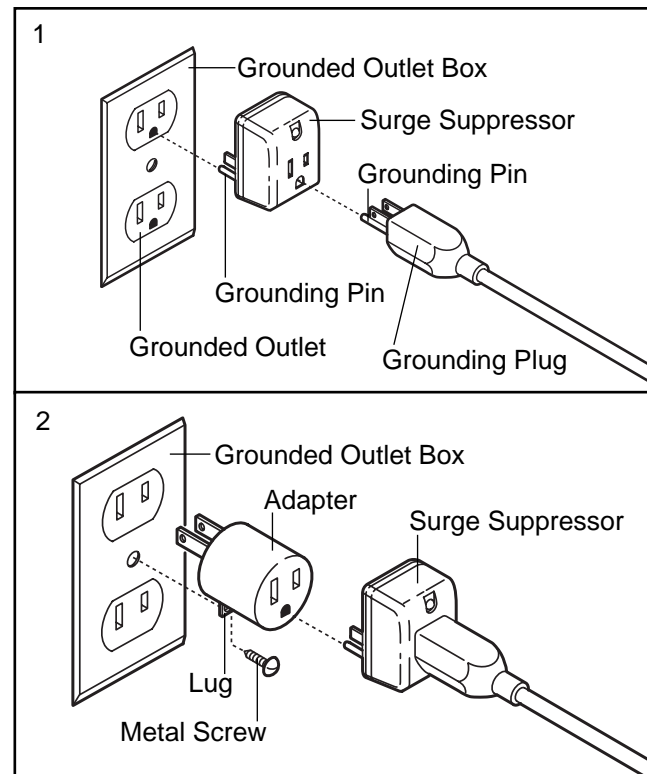

The temporary adapter should be used only until a properly grounded outlet (drawing 1) can be installed by a qualified electrician.

The green-colored rigid ear, lug, or the like extending from the adapter must be connected to a permanent ground such as a properly grounded outlet box cover. Whenever the adapter is used it must be held in place by a metal screw. **Some 2-pole receptacle outlet box covers are not grounded. Contact a qualified electrician to determine if the outlet box cover is grounded before using an adapter.**

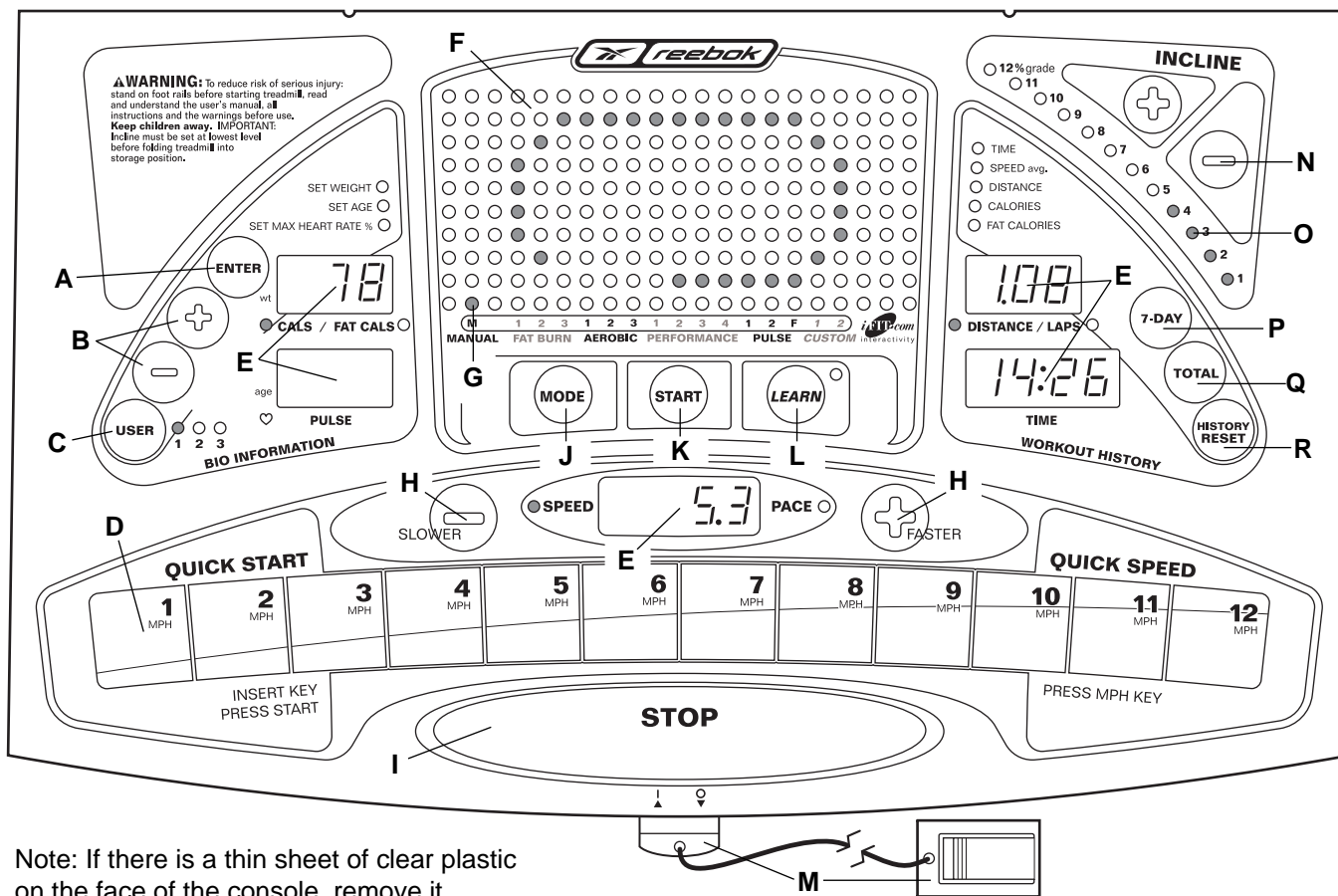

Note: If there is a thin sheet of clear plastic on the face of the console, remove it.

## FEATURES OF THE CONSOLE

The advanced console offers an impressive array of features to make your workouts more effective. When the console is in the manual mode, the speed and incline level of the treadmill can be changed with a touch of a button. As you exercise, the LED displays will provide continuous exercise feedback.

The console also offers thirteen preset workout programs—ten programs that automatically control the speed and incline of the treadmill as they guide you through effective fat-burning, aerobic, or performance workouts; two pulse programs that control the speed and the incline of the treadmill to keep your heart rate near target heart rate settings during your workouts; and a pulse-based fitness test program that estimates your relative fitness level.

You can even create your own custom workout programs and store them in memory for future use.

In addition, the console features a workout history mode that keeps track of the total hours you have exercised, the miles you have walked or run, the calories and fat calories you have burned, and your average speed. The console can display the totals for the previous 7 days or the totals since the workout history mode was last reset.

The console also features new iFIT.com interactive technology. iFIT.com technology is like having a personal trainer right in your home. Using the included audio cable, you can connect the treadmill to your home stereo, portable stereo, or computer and play special iFIT.com CD programs (CDs are available separately). iFIT.com CD programs automatically control the speed and incline of the treadmill as a personal trainer guides you through every step of your workout. High-energy music provides added motivation. Each CD features two programs designed by certified personal trainers.

In addition, you can connect the treadmill to your VCR and TV and play iFIT.com video programs (videocassettes are available separately). Video programs offer the same benefits as iFIT.com CD programs, but add the excitement of working out with a class and an instructor—the hottest new trend at health clubs.

With the treadmill connected to your computer, you can also go to our Web site at [www.iFIT.com](http://www.iFIT.com) and access basic programs, audio programs, and video programs directly from the internet. Additional options are soon to be available. See [www.iFIT.com](http://www.iFIT.com) for details.

To purchase iFIT.com CDs or videocassettes, call toll-free 1-800-735-0768.

## DIAGRAM OF THE CONSOLE

See the drawing on page 10.

- A. ENTER Button—This button is used to enter age, weight, and maximum heart rate settings.
- B. + and – Buttons—These buttons are used to change age, weight, and maximum heart rate settings.
- C. USER Button—This button is used to select user information. Up to three different users can store age, weight, and maximum heart rate settings.
- D. QUICK SPEED Buttons—These buttons allow you to quickly select speed settings.
- E. LED Displays—These displays provide continuous feedback of the calories and fat calories you have burned, the elapsed time, the distance you have walked or run, the number of laps you have completed, the speed of the walking belt, and your current pace. In addition, the PULSE display shows your heart rate when the heart rate monitor is worn.  
**Note: The console can display speed and distance in either miles or kilometers (see page 14). For simplicity, all instructions in this manual refer to miles.**
- F. LED Matrix—When the manual mode is selected, the matrix will show your progress on an LED track. When a workout program is selected, the matrix will show the upcoming speed or target heart rate settings of the program.
- G. Manual/Program Indicators—These indicators show when the manual mode, a workout program, or the iFIT.com mode is selected.
- H. SPEED Buttons—These buttons control the speed of the walking belt. Each time a button is pressed, the speed will change by 0.1 mph; if a button is held down, the speed will change in increments of 0.5 mph. The speed range is 0.5 mph to 12 mph.
- I. STOP Button—This button stops the walking belt. When the button is pressed, the LED displays will pause and the TIME display will flash.
- J. MODE Button—This button is used to select the manual mode, workout programs, and the iFIT.com mode.
- K. START Button—This button starts the walking belt.
- L. LEARN Button—This button is used to program speed and incline settings for custom programs.
- M. Key with Clip—The key turns the console on and off. The attached clip is designed to be worn on your waistband. If the key is pulled from the console, the power will automatically turn off.
- N. INCLINE Buttons—These buttons control the incline of the treadmill. Each time a button is pressed, the incline will change by 0.5%. The incline range is 0% to 12%.
- O. INCLINE Display—This display shows the incline level of the treadmill. Note: No indicators will light when the incline is at 0% or 0.5%; the first indicator will light when the incline is at 1% or 1.5%; the second indicator will light when the incline is at 2% or 2.5%; the third indicator will light when the incline is at 3% or 3.5%, etc.
- P. 7-DAY Button—This button allows you to view the number hours you have exercised, the miles you have walked or run, the calories and fat calories you have burned, and your average speed for the previous 7 days (see THE WORKOUT HISTORY MODE on page 21).
- Q. TOTAL Button—This button allows you to view the total hours you have exercised, the miles you have walked or run, the calories and fat calories you have burned, and your average speed since the workout history mode was last reset.
- R. HISTORY RESET button—This button resets the workout history mode.

**CAUTION:** Before operating the console, read the following precautions.

- Do not stand on the walking belt when turning on the power or starting the walking belt.
- Always wear the clip (see M on page 10) while operating the treadmill. If the key is pulled from the console, the walking belt will stop.
- The treadmill is capable of high speeds; adjust the speed in small increments.
- The heart rate monitor is not a medical device. Various factors may affect the accuracy of heart rate readings. The heart rate monitor is intended only as an exercise aid in determining heart rate trends in general.
- If you have heart problems, or if you are over 60 years of age and have been inactive, do not use the three pulse-driven programs. If you are taking medication regularly, consult your physician to find whether the medication will affect your exercise heart rate.
- To reduce the risk of electric shock, keep the console dry. Avoid spilling liquid on the console and use only a sealable water bottle.

## HOW TO TURN ON THE POWER

Make sure that the reset/off circuit breaker, located on the front of the treadmill, is in the reset position.

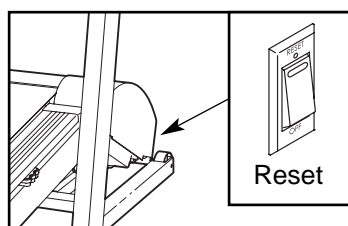

Next, make sure that the power cord is properly plugged in (see page 9).

Stand on the foot rails of the treadmill. Find the clip attached to the key (see M on page 10), and slide the clip onto the waistband of your clothes. Next, insert the key fully into the console. After a moment, various displays and indicators will light. **Test the clip by carefully taking a few steps backward until the key is pulled from the console. If the key is not pulled from the console, adjust the position of the clip as needed.** Then, re-insert the key fully into the console.

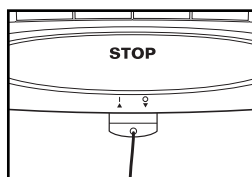

To use the manual mode, follow the steps beginning on page 13. To use a fat burn, aerobic, or performance program, see page 15. To use a pulse program, see page 16. To use the fitness test program, see page 17. To create and use a custom program, see pages 19 and 20. To use the workout history mode, see page 21. To use an iFIT.com CD or video program, see page 24. To use an iFIT.com program directly from our Web site, see page 26.

## HOW TO ENTER USER INFORMATION

Each time the power is turned on, the USER 1 indicator will begin to flash. The console allows up to three different users to enter their weight, their age, and a maximum heart rate setting into the console.

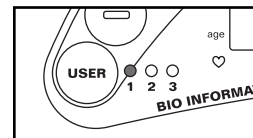

If you enter your weight into the console, the CALS/FAT CALS display will be more accurate. If you want to use the fitness test program, you must enter your age. If you want to use pulse programs 1 or 2, you must enter your age and a maximum heart rate setting.

If you want to enter your weight, your age, or a maximum heart rate setting, follow the instructions below.

### 1 Press the USER button.

Press the USER button to designate yourself as user 1. The USER 1 indicator will remain lit without flashing. Note: To designate yourself as user 2 or user 3, press the USER button repeatedly. **IMPORTANT: Each time you use the treadmill, make sure that the correct user is selected.**

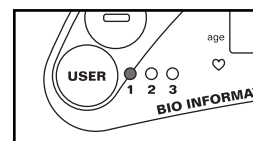

### 2 Enter your weight if desired.

The current weight setting will be shown in the CALS/FAT CALS display. Press the + or – button to enter your weight. Each button press will change the weight setting by 1 pound; if a button is held down, the weight setting will change in increments of 5 pounds. When your weight is shown, press the ENTER button. Note: Once your weight is entered, it will be saved in memory, even when the power cord is unplugged.

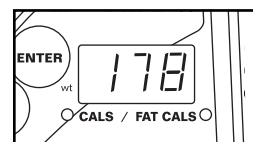

### 3 Enter your age if desired.

The current age setting will be shown in the PULSE display. Press the + or – button to enter your age. Each button press will change the age setting by 1 year; if a button is held down, the age setting will change in increments of 5 years. When your age is shown, press the ENTER button. Note: Once your age is entered, it will be saved in memory, even when the power cord is unplugged.

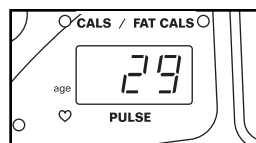

### 4 Enter a maximum heart rate setting if desired.

The current maximum heart rate setting will be shown in the LED matrix. When pulse programs 1 or 2 are used, this is the highest level that your heart rate will reach during the program. This setting is a *percentage of your estimated maximum heart rate*. (Your estimated maximum heart rate is 220 minus your age. For example, if you are 30 years old, your estimated maximum heart rate is 190.)

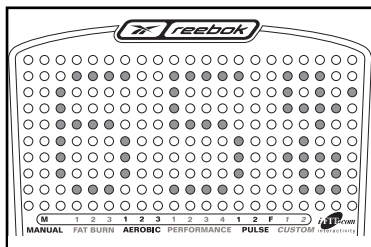

If desired, you can change the maximum heart rate setting by pressing the + and – buttons. Each button press will change the setting by 1%; if a button is held down, the setting will change in increments of 5%. The setting can be from 65% to 85%. When the desired setting is shown, press the ENTER button. Note: When the key is removed from the console, the maximum heart rate setting will be reset to 65%.

## HOW TO USE THE MANUAL MODE

### 1 Insert the key fully into the console.

See HOW TO TURN ON THE POWER on page 12.

### 2 Select user 1, 2, or 3.

When the key is inserted, user 1 will be selected, as shown by the USER 1 indicator. If you have designated yourself as user 2 or 3, press the USER button repeatedly until the appropriate indicator lights.

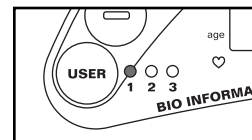

### 3 Enter your weight if desired.

If you have not entered your weight, see HOW TO ENTER USER INFORMATION on page 12.

### 4 Select the manual mode.

When the key is inserted, the manual mode will be selected. If you have selected a workout program or the iFIT.com mode, you can select

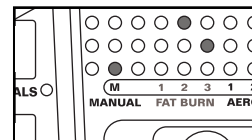

the manual mode again by pressing the MODE button repeatedly until the manual indicator lights.

### 5 Press the START button or the SPEED + button to start the walking belt.

A moment after the button is pressed, the walking belt will begin to move at 1.0 mph. Hold the handrails and begin walking. As you exercise, change the speed of the walking belt as desired by pressing the SPEED buttons or the QUICK SPEED buttons. **CAUTION: Change the speed in small increments to avoid sudden jumps in speed.**

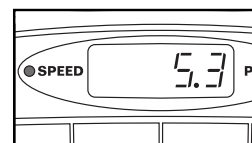

To stop the walking belt, press the STOP button. The displays will pause and the TIME display will begin to flash. To restart the walking belt, press the START button or the SPEED + button.

Note: When either of the SPEED buttons is pressed, the SPEED/PACE display will show the selected speed setting for seven seconds. The display will then show the actual speed of the walking belt.

Note: During the first few minutes that the treadmill is used, inspect the alignment of the walking belt and align it if necessary (see page 29).

## 6 Adjust the incline as desired.

To vary the intensity of your workout, change the incline of the treadmill as desired by pressing the INCLINE buttons. Note: After the INCLINE buttons are pressed, it will take a moment for the treadmill to reach the selected incline setting.

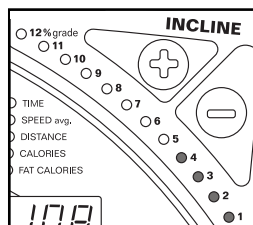

## 7 Follow your progress with the LED track and the LED displays.

**The LED Track**—The LED track represents a distance of 1/4 mile. As you exercise, the indicators around the track will light one at a time until you have completed 1/4 mile. A new lap will then begin.

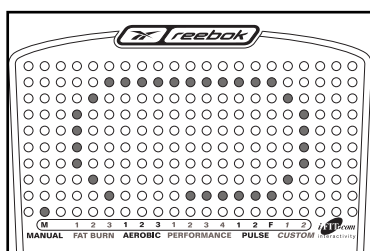

**CALS/FAT CALS display**—This display shows the approximate numbers of *calories* and *fat calories* you have burned (see FAT BURNING on page 33). Every seven seconds, the display will change from one number to the other.

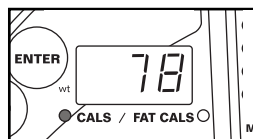

**PULSE display**—This display shows your heart rate when the heart rate monitor is worn. (See page 7.)

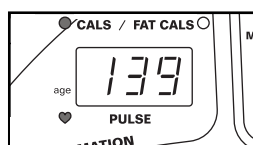

**SPEED/PACE display**—This display shows the speed of the walking belt and your current pace (pace is measured in *minutes per mile*). The display will alternate between one number and the other every seven seconds. Note: When either of the SPEED buttons is pressed, the display will show the speed setting.

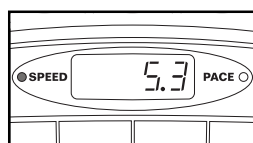

**How to select miles per hour or kilometers per hour:** Speed can be displayed in either miles per hour (mph) or kilometers per hour (kph). To change the unit of measurement, first hold down the STOP button while inserting the key into the console. The SPEED/PACE display will show either an "E" for English miles or an "M" for Metric kilometers. Press the SPEED + button to change the unit of measurement. Then, remove and reinsert the key.

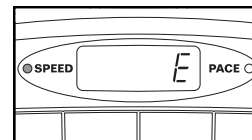

**DISTANCE/LAPS display**—This display shows the distance that the walking belt has moved and the number of laps you have completed (one lap equals 1/4 mile). The display will alternate between one number and the other every seven seconds.



Note: If the speed is displayed in miles per hour, the distance will be displayed in miles; if the speed is displayed in kilometers per hour, the distance will be displayed in kilometers.

**TIME display**—This display shows the total time that the walking belt has been moving. Note: When a workout program is selected, this display will show the time remaining in the program.



## 8 When you are finished exercising, stop the walking belt and remove the key.

Step onto the foot rails, press the STOP button, and **change the incline of the treadmill to the lowest setting. The incline must be at the lowest setting when the treadmill is folded to the storage position or the treadmill will be damaged.** Remove the key from the console and put it in a secure place. Finally, switch the reset/off circuit breaker to the off position and unplug the power cord.

## HOW TO USE FAT BURN, AEROBIC, AND PERFORMANCE PROGRAMS

The ten fat burn, aerobic, and performance programs automatically control the speed and incline of the treadmill as they guide you through effective workouts designed to help you achieve specific exercise goals.

Follow the steps below to use a fat burn, aerobic, or performance program.

### 1 Insert the key fully into the console.

See HOW TO TURN ON THE POWER on page 12.

### 2 Select user 1, 2, or 3.

See step 2 on page 13.

### 3 Enter your weight if desired.

If you have not entered your weight, see HOW TO ENTER USER INFORMATION on page 12.

### 4 Select the desired program.

When the key is inserted, the manual mode will be selected. To select a fat burn, aerobic, or performance program, press the MODE button

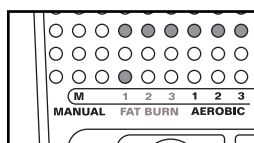

repeatedly until one of the fat burn, aerobic, or performance indicators lights. The LED matrix will show the first eighteen speed settings of the program you have selected. The SPEED/PACE display will flash the program's maximum speed setting and the INCLINE display will flash the program's maximum incline setting for ten seconds.

### 5 Press the START button or the SPEED + button to start the program.

A moment after the button is pressed, the treadmill will automatically adjust to the first speed and incline settings for the program. Hold the handrails and begin walking.

Each program is divided into several time periods of different lengths. One speed setting and one incline setting are programmed for each period. The speed setting for the first period is shown in the flashing CURRENT PERIOD column of the LED matrix. (The incline settings are not shown in the

matrix.) The speed settings for the next eighteen periods will be shown in the eighteen columns to the right.

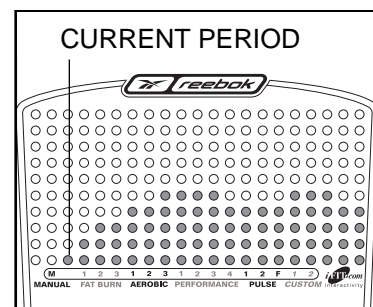

When only three seconds remain in the first period of the program, both the CURRENT PERIOD column and the column to the right will flash, a series of tones will sound, and *all speed settings will move one column to the left*. The speed setting for the second period will then be shown in the flashing CURRENT PERIOD column and the treadmill will automatically adjust to the speed and incline settings for the second period.

The program will continue in this way until the speed setting for the last period is shown in the CURRENT PERIOD column and the TIME display counts down to zero. The walking belt will then slow to a stop.

Note: Each time a period ends and the speed settings move to the left, *if all of the indicators in the CURRENT PERIOD column are lit, the speed settings may move downward so that only the highest indicators in the columns will appear in the LED matrix*. When the speed settings move to the left again and not all of the indicators in the CURRENT PERIOD column are lit, the speed settings will move back up.

If the speed or incline setting for the current period is too high or too low, you can manually override the setting by pressing the SPEED or INCLINE buttons. Every few times one of the SPEED buttons is pressed, an additional indicator will light or darken in the CURRENT PERIOD column. If any of the columns to the right of the CURRENT PERIOD column have the same number of lit indicators as the CURRENT PERIOD column, an additional indicator may light or darken in those columns as well. Note: If you *manually* adjust the speed setting so that all of the indicators in the CURRENT PERIOD column are lit, the speed settings in the LED matrix will *not* move downward as described above. **Note: If you manually override the speed or incline setting for the current period, when the period ends the treadmill will automatically adjust to the speed and incline settings for the next period.**

To stop the program temporarily, press the STOP button. The TIME display will begin to flash. To restart the program, press the START button or the SPEED + button. To end the program, press the STOP button, remove the key, and then reinsert the key.

**6 Follow your progress with the LED displays.**

See step 7 on page 14.

**7 When the program is completed, remove the key.**

**Make sure that the incline of the treadmill is at the lowest setting. The incline must be at the lowest setting when the treadmill is folded to the storage position or the treadmill will be damaged.** Next, remove the key from the console and put it in a secure place. Finally, switch the reset/off circuit breaker to the off position and unplug the power cord.

**HOW TO USE PULSE PROGRAMS 1 AND 2**

Pulse programs 1 and 2 automatically control the speed and incline of the treadmill to keep your heart rate within a predetermined range during your workouts.

Follow the instructions below to use pulse programs 1 or 2.

**1 Insert the key fully into the console.**

See HOW TO TURN ON THE POWER on page 12.

**2 Select user 1, 2, or 3.**

See step 2 on page 13.

**3 Enter your weight, your age, and a maximum heart rate setting.**

If you enter your weight into the console, the CALS/FAT CALS display will be more accurate. **To use pulse programs 1 or 2, you must enter your age and a maximum heart rate setting.** If you have not entered this information, see HOW TO ENTER USER INFORMATION on page 12.

**4 Put on the heart rate monitor.**

The heart rate monitor must be worn when a pulse program is used. (See HOW TO USE THE HEART RATE MONITOR on page 7.) Note: A pulse pro-

gram can be started without a heart rate reading; however, the speed and/or incline of the treadmill will automatically decrease if your heart rate is not detected during the program.

**5 Select the desired program.**

When the key is inserted, the manual mode will be selected. To select pulse program 1 or 2, press the MODE button repeatedly until the pulse program 1 or 2 indicator lights. The first nineteen target heart rate settings of the program you have selected will appear in the LED matrix.

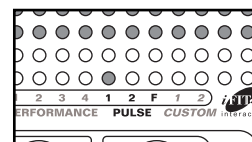

**6 Press the START button or the SPEED + button to start the program.**

A moment after the button is pressed, the treadmill will automatically adjust to the first speed and incline settings for the program. Hold the handrails and begin walking.

Pulse programs 1 and 2 consist of twenty-three, one-minute periods. One target heart rate setting is programmed for each period. The target heart rate setting for the first period will be shown in the flashing CURRENT PERIOD column of the LED matrix. The target heart rate settings for the next eighteen periods will be shown in the eighteen columns to the right.

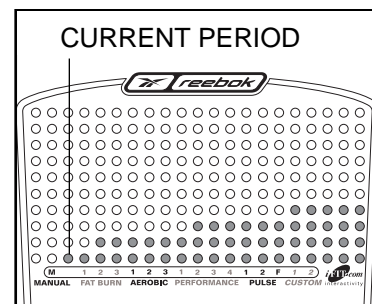

When only three seconds remain in the first period of the program, both the CURRENT PERIOD column and the column to the right will flash and a series of tones will sound. All target heart rate settings will then move one column to the left. The target heart rate setting for the second period will then be shown in the CURRENT PERIOD column.

As the program progresses, the speed and/or incline of the treadmill will change automatically to keep your heart rate near the heart rate setting shown in the CURRENT PERIOD column. The program will continue until the heart rate setting for the last period is shown in the CURRENT PERIOD column and the TIME display counts down to zero. The walking belt will then slow to a stop.



If your heart rate is not detected during the program, the letters "PLS" will flash in the PULSE display and the speed and/or incline of the treadmill will automatically decrease. (See HEART RATE MONITOR TROUBLESHOOTING on page 7.)

While the program is in progress, minor adjustments can be made to the speed or incline of the treadmill with the SPEED or INCLINE buttons. However, if you *increase* the speed, the incline will automatically *decrease*; if you *decrease* the speed, the incline will *increase*. If you *increase* the incline, the speed will *decrease*; if you *decrease* the incline, the speed will *increase*. *The console will always attempt to keep your heart rate near the heart rate setting shown in the CURRENT PERIOD column.* Note: When the incline reaches the lowest setting, the speed cannot be increased any further. When the incline reaches the highest setting, the speed cannot be decreased any further.

To stop the program, press the STOP button. Pulse programs should not be stopped temporarily and then restarted. To use the pulse program again, re-select the program and start it at the beginning.

**7 Follow your progress with the LED displays.**

See step 7 on page 14.

**8 When the program is completed, remove the key.**

See step 7 on page 16.

## HOW TO USE THE FITNESS TEST PROGRAM

The fitness test program is designed to estimate the relative fitness level you have achieved. For the best results, the fitness test program should be used at a time when your energy level is high; the program should not be used if you have already exercised during the day.

The fitness test program consists of up to seven 4-minute segments and is followed by a 2-minute cool-down period. The speed and/or incline of the treadmill will automatically increase at the beginning of each 4-minute segment. When your heart rate reaches 70% of your estimated maximum heart rate, the FITNESS TEST will end. After a 2-minute cool-down period, the console will display your estimated fitness level.

To use the fitness test program, follow the steps below.

**1 Insert the key fully into the console.**

See HOW TO TURN ON THE POWER on page 12.

**2 Select user 1, 2, or 3.**

See step 2 on page 13.

**3 Enter your age into the console.**

**To use the fitness test program, you must enter your age.** If you have not entered your age, see HOW TO ENTER USER INFORMATION on page 12.

**4 Put on the heart rate monitor.**

The heart rate monitor must be worn when the fitness test program is used. (See HOW TO USE THE HEART RATE MONITOR on page 7.) Note: The fitness test program can be started without a heart rate reading; however, the program will automatically stop if your heart rate is not detected 4 minutes after the program is started.

**5 Select the fitness test program.**

When the key is inserted, the manual mode will be selected. To select the fitness test program, press the MODE button repeatedly until the "F" indicator lights.

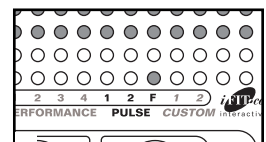

The first eighteen speed settings of the program will appear in the LED matrix.

**6 Press the START button or the SPEED + button to start the program.**

A moment after the button is pressed, the incline of the treadmill will automatically adjust to 3% and the walking belt will begin to move at 1.5 mph. The DISTANCE/LAPS display will show an "L 1" (level 1), indicating that the first 4-minute segment of the fitness test program has begun. Hold the handrails and begin walking.

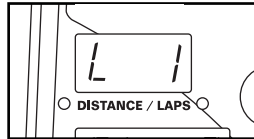

The fitness test program is divided into seven, four-minute segments. Each segment consists of four, one-minute periods. One speed setting and one incline setting are programmed for each period. The speed setting for the first period will be shown in the flashing

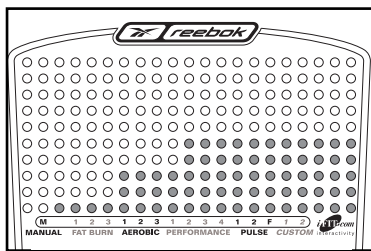

CURRENT PERIOD column of the LED matrix. (The incline settings are not shown in the matrix.) The speed settings for the next eighteen periods will be shown in the eighteen columns to the right.

When only three seconds remain in the first period of the program, both the CURRENT PERIOD column and the column to the right will flash, a tone will sound, and all speed settings will move one column to the left. The speed setting for the second period will then be shown in the flashing CURRENT PERIOD column.

When the first four-minute segment of the program is completed, both the CURRENT PERIOD column and the column to the right will flash, a series of tones will sound, and all speed settings will move one column to the left. The LED matrix will then show an "L 2," indicating that the second 4-minute segment has begun. The incline will then adjust to 4% and the speed will increase to 2.5 mph.

At the beginning of each four-minute segment, the speed and/or incline of the treadmill will automatically increase. The fitness test program will continue in this way *until your heart rate reaches 70% of your estimated maximum heart rate, and the current four-minute segment is completed. The fitness test program will then be completed, regardless of how many segments remain.*

When the fitness test program is completed, the letter "C" will appear in the DISTANCE/LAPS display and a two-minute cool-down period will begin. The incline will then adjust to 1% and the speed will decrease.

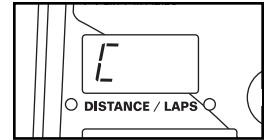

When the cool-down period is completed, the walking belt will slow to a stop and your fitness level will be shown in the TIME display. There are ten fitness levels—fitness level 10 (FL:10) is the highest. Remember, the fitness test program is intended only to indicate your relative fitness level.

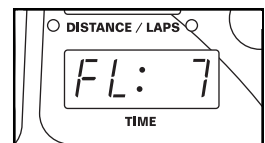

Note: The SPEED and INCLINE buttons will not function while the fitness test program is selected. If your pulse is not detected during the program, the letters "PLS" will flash in the PULSE display. If your pulse is not detected during the last thirty seconds of any four-minute segment (after four minutes, after eight minutes, etc.), the fitness test program will end and the TIME display will show a fitness level of 0 (FL: 0).

The fitness test program cannot be stopped temporarily and then restarted. However, the program can be stopped at any time by pressing the STOP button. The TIME display will then show an estimated fitness level.

**7 When the program is completed, remove the key.**

See step 7 on page 16.

## HOW TO CREATE CUSTOM PROGRAMS

Custom programs 1 and 2 are workout programs that you create. The programs control both the speed and incline of the treadmill, and can be up to 40 minutes long. The programs are stored in memory and can be changed as many times as desired.

Follow the steps below to create a custom program.

### 1 Insert the key fully into the console.

See HOW TO TURN ON THE POWER on page 12.

### 2 Select user 1, 2, or 3.

See step 2 on page 13.

### 3 Enter your weight if desired.

If you have not entered your weight, see HOW TO ENTER USER INFORMATION on page 12.

### 4 Select custom program 1 or 2.

When the key is inserted, the manual mode will be selected. To select a custom program, press the MODE button repeatedly until the custom 1 or 2 indicator lights.

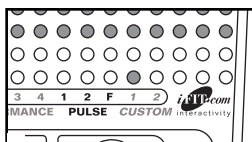

### 5 Press the START button or the SPEED + button to start the program.

A moment after the button is pressed, the walking belt will begin to move. Hold the handrails and begin walking.

### 6 Press the LEARN button and program the desired speed and incline settings.

When the LEARN button is pressed, the LEARN indicator will light. **Speed and incline settings can be programmed only when the indicator is lit.**

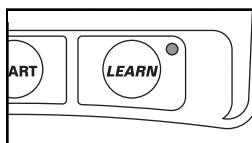

Each program is divided into one-minute periods. One speed setting and one incline setting can be

programmed for each period. The speed setting for the first period is shown in the flashing CURRENT PERIOD column of the LED matrix.

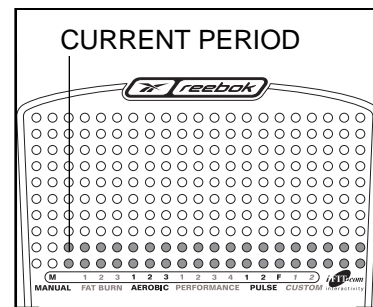

(The incline settings are not shown in the matrix.) To program speed and incline settings for the first period, simply adjust the speed and incline of the treadmill to the desired levels with the SPEED and INCLINE buttons. Every few times the SPEED buttons are pressed, one additional indicator will light or darken in the CURRENT PERIOD column.

When the first period of the program is completed, three tones will sound and the current speed and incline settings will be stored in memory. All speed settings shown in the LED matrix will then move one column to the left and the speed setting for the second period will be shown in the flashing CURRENT PERIOD column. Program speed and incline settings for the second period as described above. Repeat this procedure until you have programmed speed and incline settings for as many periods as desired. Programs can have up to forty periods.

Note: To stop the program for a moment, press the STOP button. The displays will pause and the TIME display will begin to flash. To restart the program, press the START or SPEED + button.

### 7 Press the STOP button, remove the key, and then reinsert the key.

When you have programmed speed and incline settings for as many one-minute periods as desired, press the STOP button, remove the key, and then reinsert the key. The speed and incline settings that you have programmed and the length of the program will be stored in memory. To use the program again, see HOW TO USE CUSTOM PROGRAMS on page 20.

### 8 When the program is completed, remove the key.

See step 7 on page 16.

## HOW TO USE CUSTOM PROGRAMS

### 1 Insert the key fully into the console.

See HOW TO TURN ON THE POWER on page 12.

### 2 Select user 1, 2, or 3.

See step 2 on page 13.

### 3 Enter your weight if desired.

If you have not entered your weight, see HOW TO ENTER USER INFORMATION on page 12.

### 4 Select custom program 1 or 2.

When the key is inserted, the manual mode will be selected.

To select a custom program, press the MODE button repeatedly until the custom 1 or 2 indicator lights.

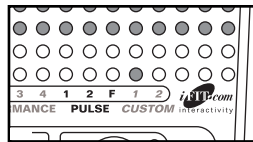

### 5 Press the START button or the SPEED + button to start the program.

A moment after the button is pressed, the walking belt will begin to move. Hold the handrails and begin walking.

Each custom program is divided into one-minute periods. One speed setting and one incline setting are programmed for each period. The speed setting for the first period is shown in the flashing CURRENT PERIOD column of the LED matrix. (The incline settings are not shown in the matrix.)

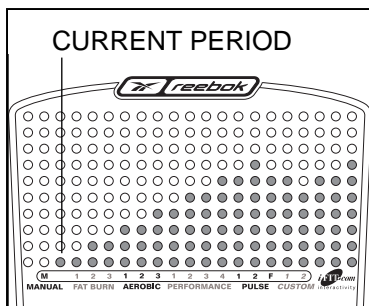

When only three seconds remain in the first period of the program, both the CURRENT PERIOD column and the column to the right will flash and three tones will sound. All speed settings will then move one column to the left. The speed setting for the second period will then be shown in the CURRENT PERIOD column and the speed and incline of the treadmill will adjust to the second settings that you programmed previously.

The program will continue in this way until the speed setting for the last period is shown in the CURRENT PERIOD column and the TIME display counts down to zero. The walking belt will then slow to a stop.

During the program, the speed and incline settings of the current period can be adjusted with the SPEED and INCLINE buttons. Adjustments will not be stored in memory. To **reprogram** speed and incline settings, press the LEARN button. The LEARN indicator will light. **Speed and incline settings can be reprogrammed only when the indicator is lit.** Next, adjust the speed and incline of the treadmill with the SPEED and INCLINE buttons. *When the current period of the program is completed*, the new speed and incline settings will be stored in memory. When you have reprogrammed speed and incline settings for as many periods as desired, press the LEARN button again.

To stop the program temporarily, press the STOP button. The TIME display will begin to flash. To restart the program, press the START button or the SPEED + button. To end the program, press the STOP button, remove the key, and then reinsert the key.

### 6 Follow your progress with the LED displays.

See step 7 on page 14.

### 7 When the program is completed, remove the key.

See step 7 on page 16.

## THE WORKOUT HISTORY MODE

The console features a workout history mode that keeps track of the total hours you have exercised, the miles you have walked or run, the calories and fat calories you have burned, and your average speed. The console can display the totals for the previous 7 days or the totals since the workout history mode was last reset.

### 1 Enter the current time into the console.

If you have previously entered the current time, go to step 2.

For the workout history mode to be accurate, the current time must be entered into the console. To check the time setting, first hold down the STOP button while inserting the key into the console. The time setting will appear in the TIME display. Note: The console uses a 24-hour clock; if the current time is 6:45 pm, the display should show 18:45.

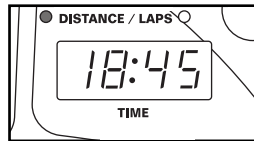

To change the time setting, first press the LEARN button. The minute digits in the TIME display will begin to flash. Press the USER + or – button to set the minute digits to the correct time. Press the LEARN button again. The hour digits will begin to flash. Press the + or – button to enter the correct hour. Then, press the LEARN button again. When the correct time is shown, remove the key from the console and then reinsert it. Note: Once the current time is entered, it will be saved in memory, even when the power cord is unplugged.

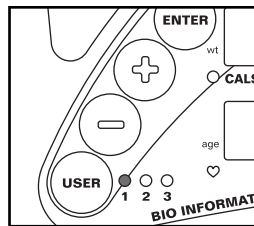

### 2 Select user 1, 2, or 3.

See step 2 on page 13.

### 3 If the walking belt is moving, press the STOP button.

To access the workout history mode, the walking belt must be stopped.

### 4 Press the 7-DAY button or the TOTAL button.

When the 7-DAY button or the TOTAL button is

pressed, the TIME display will show the total number of hours you have exercised. Note: The total will be rounded off to the nearest hour. If the total reaches 10,000 hours, the display will reset to zero.

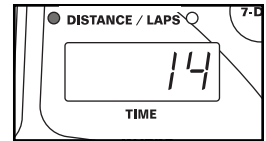

Press the 7-DAY button or the TOTAL button again. The SPEED/PACE display will show your average speed.

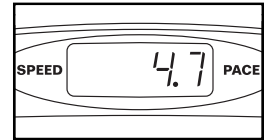

Press the 7-DAY button or the TOTAL button again. The DISTANCE/LAPS display will show the total number of miles you have walked or run. Note: The total will be rounded off to the nearest mile. If the total reaches 1,000 hours, the display will reset to zero.

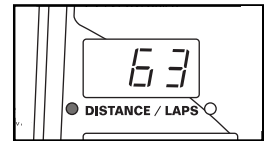

Press the 7-DAY button or the TOTAL button again. The CALS/FAT CALS display will show the total number of calories you have burned. Note: The total is shown in *thousandths*; if the display shows 1.02, for example, you have burned 1,020 calories. If the total reaches 10,000 calories, the display will reset to zero.



Press the 7-DAY button or the TOTAL button again. The CALS/FAT CALS display will show the total number of fat calories you have burned. Note: The total is shown in *thousandths*; if the display shows 1.02, for example, you have burned 1,020 fat calories. If the total reaches 10,000 fat calories, the display will reset to zero.



### 5 Reset the workout history mode if desired.

To reset the workout history mode, press the HISTORY RESET button. All displays will be reset to zero.

### 6 Exit the workout history mode.

To exit the workout history mode, press any button on the console except the 7-DAY, TOTAL, or HISTORY RESET button.

## HOW TO CONNECT THE TREADMILL TO YOUR CD PLAYER, VCR, OR COMPUTER

To use **iFIT.com CDs**, the treadmill must be connected to your portable CD player, portable stereo, home stereo, or computer with CD player. See pages 22 and 23 for connecting instructions. To use **iFIT.com videocassettes**, the treadmill must be connected to your VCR. See page 24 for connecting instructions. To use **iFIT.com programs directly from our Web site**, the treadmill must be connected to your home computer. See page 23 for connecting instructions.

## HOW TO CONNECT YOUR PORTABLE CD PLAYER

**Note:** If your CD player has separate **LINE OUT** and **PHONES** jacks, see instruction A below. If your CD player has only one jack, see instruction B.

- A. Plug one end of the audio cable into the jack on the front of the treadmill near the power cord. Plug the other end of the cable into the **LINE OUT** jack on your CD player. Plug your headphones into the **PHONES** jack.

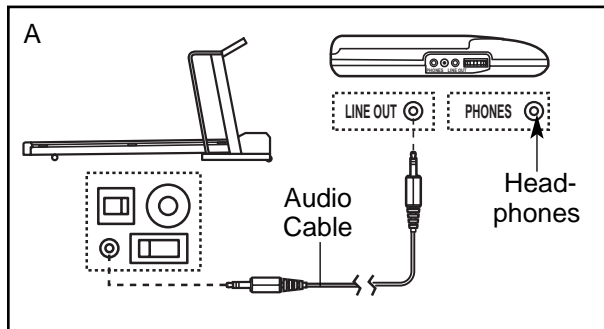

- B. Plug one end of the audio cable into the jack on the front of the treadmill near the power cord. Plug the other end of the cable into a 3.5mm Y-adapter (available at electronics stores). Plug the Y-adapter into the **PHONES** jack on your CD player. Plug your headphones into the other side of the Y-adapter.

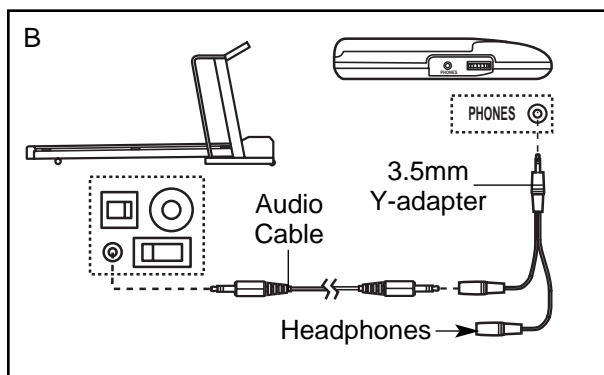

## HOW TO CONNECT YOUR PORTABLE STEREO

**Note:** If your stereo has an **RCA-type AUDIO OUT** jack, see instruction A below. If your stereo has a **3.5mm LINE OUT** jack, see instruction B. If your stereo has only a **PHONES** jack, see instruction C.

- A. Plug one end of the audio cable into the jack on the front of the treadmill near the power cord. Plug the other end of the cable into the included adapter. Plug the adapter into an **AUDIO OUT** jack on your stereo.

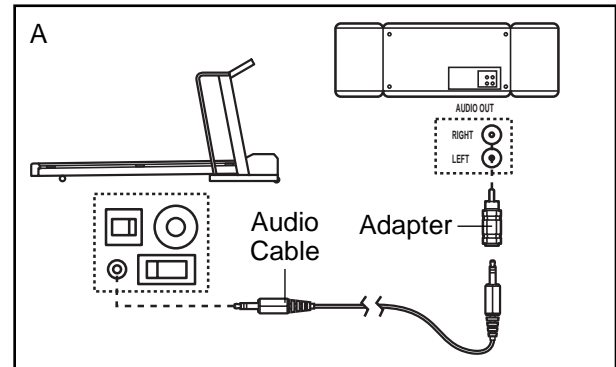

- B. Plug one end of the audio cable into the jack on the front of the treadmill near the power cord. Plug the other end of the cable into the **LINE OUT** jack on your stereo.

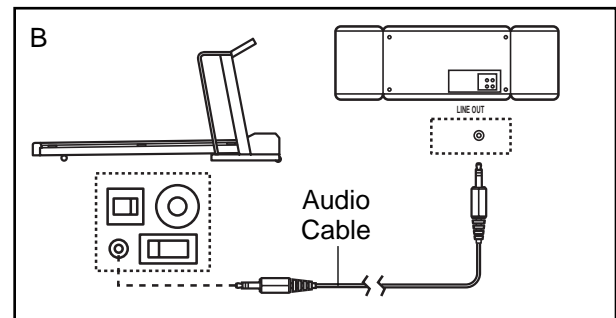

- C. Plug one end of the audio cable into the jack on the front of the treadmill near the power cord. Plug the other end of the cable into a 3.5mm Y-adapter (available at electronics stores). Plug the Y-adapter into the **PHONES** jack on your stereo. Plug your headphones into the other side of the Y-adapter.

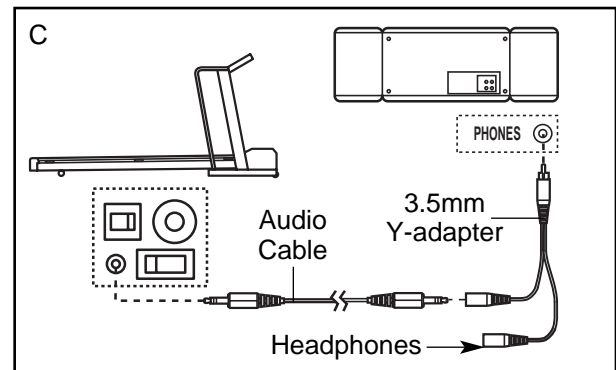

## HOW TO CONNECT YOUR HOME STEREO

**Note:** If your stereo has an unused **LINE OUT** jack, see instruction **A** below. If the **LINE OUT** jack is being used, see instruction **B**.

- A. Plug one end of the audio cable into the jack on the front of the treadmill near the power cord. Plug the other end of the cable into the included adapter. Plug the adapter into the **LINE OUT** jack on your stereo.

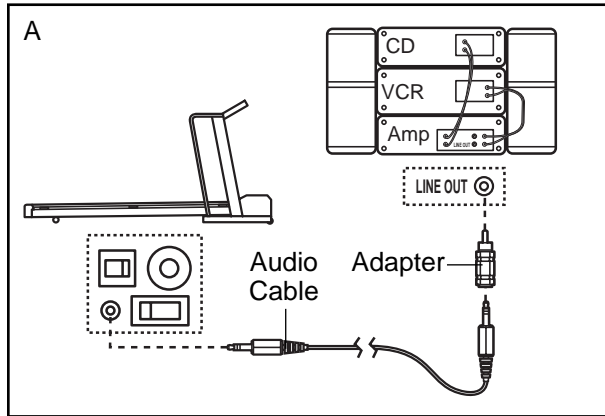

- B. Plug one end of the audio cable into the jack on the front of the treadmill near the power cord. Plug the other end of the cable into the included adapter. Plug the adapter into an **RCA Y-adapter** (available at electronics stores). Next, remove the wire that is currently plugged into the **LINE OUT** jack on your stereo and plug the wire into the unused side of the **RCA Y-adapter**. Plug the **RCA Y-adapter** into the **LINE OUT** jack on your stereo.

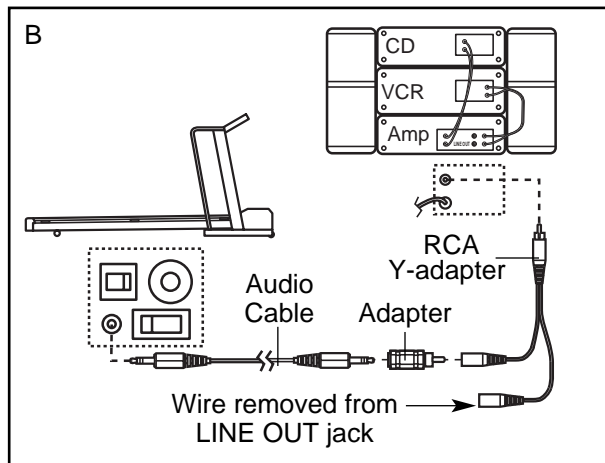

## HOW TO CONNECT YOUR COMPUTER

**Note:** If your computer has a **3.5mm LINE OUT** jack, see instruction **A**. If your computer has only a **PHONES** jack, see instruction **B**.

- A. Plug one end of the audio cable into the jack on the front of the treadmill near the power cord. Plug the other end of the cable into the **LINE OUT** jack on your computer.

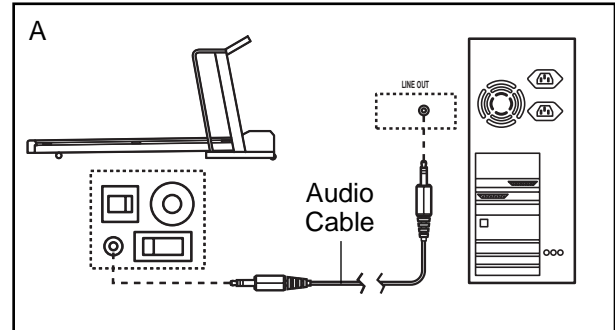

- B. Plug one end of the audio cable into the jack on the front of the treadmill near the power cord. Plug the other end of the cable into a **3.5mm Y-adapter** (available at electronics stores). Plug the **Y-adapter** into the **PHONES** jack on your computer. Plug your headphones or speakers into the other side of the **Y-adapter**.

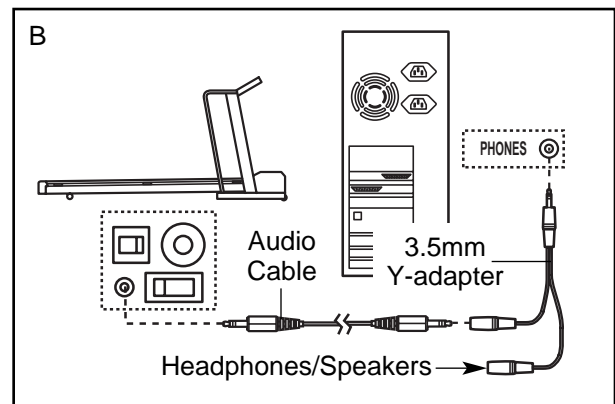

## HOW TO CONNECT YOUR VCR

**Note:** If your VCR has an unused AUDIO OUT jack, see instruction A below. If the AUDIO OUT jack is being used, see instruction B. If you have a TV with a built-in VCR, see instruction B. If your VCR is connected to your home stereo, see **HOW TO CONNECT YOUR HOME STEREO** on page 23.

- A. Plug one end of the audio cable into the jack on the front of the treadmill near the power cord. Plug the other end of the cable into the included adapter. Plug the adapter into the AUDIO OUT jack on your VCR.

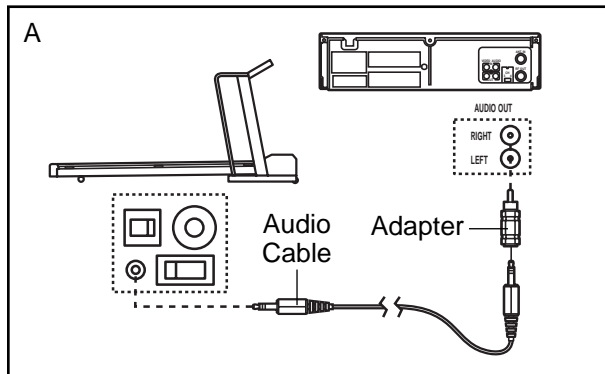

- B. Plug one end of the audio cable into the jack on the front of the treadmill near the power cord. Plug the other end of the cable into the included adapter. Plug the adapter into an RCA Y-adapter (available at electronics stores). Next, remove the wire that is currently plugged into the AUDIO OUT jack on your VCR and plug the wire into the unused side of the Y-adapter. Plug the Y-adapter into the AUDIO OUT jack on your VCR.

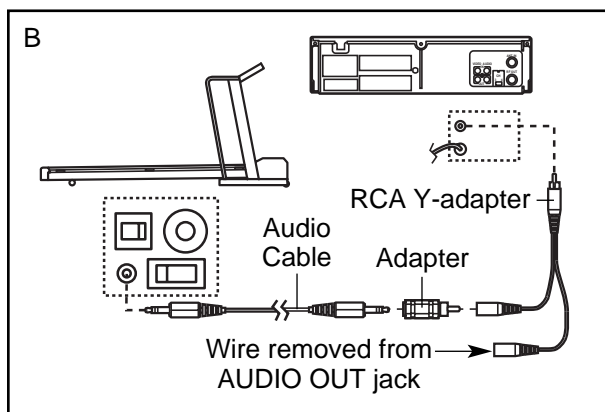

## HOW TO USE iFIT.COM CD AND VIDEO PROGRAMS

To use iFIT.com CDs or videocassettes, the treadmill must be connected to your portable CD player, portable stereo, home stereo, computer with CD player, or VCR. See **HOW TO CONNECT THE TREADMILL TO YOUR CD PLAYER, VCR, OR COMPUTER** on page 22.

**Note:** To purchase iFIT.com CDs or videocassettes, call toll-free 1-800-735-0768. Follow the steps below to use an iFIT.com CD or video program.

### 1 Insert the key fully into the console.

See **HOW TO TURN ON THE POWER** on page 12.

### 2 Select user 1, 2, or 3.

See step 2 on page 13.

### 3 Select the iFIT.com mode.

When the key is inserted, the manual mode will be selected. To use an iFIT.com CD or video program, press the MODE button repeatedly until the iFIT.com indicator lights. The letters "iFIT" and three indicators will appear in the LED matrix.

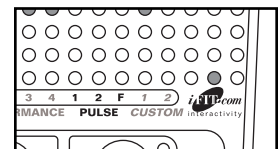

### 4 Insert the iFIT.com CD or videocassette.

If you are using an iFIT.com CD, insert the CD into your CD player. If you are using an iFIT.com videocassette, insert the videocassette into your VCR.

### 5 Press the PLAY button on your CD player or VCR.

A moment after the button is pressed, your personal trainer will begin guiding you through your workout. Simply follow your personal trainer's instructions. **Note:** If the TIME display is flashing, press the START button or the SPEED + button on the console. The treadmill will not respond to a CD or video program when the TIME display is flashing.

During the CD or video program, an electronic "chirping" sound will alert you when the speed and/or incline of the treadmill is about to change.

**CAUTION: Always listen for the "chirp" and be prepared for speed and/or incline changes. In some instances, the speed and/or incline may change before the personal trainer describes the change.**



If the speed or incline settings are too high or too low, you can manually override the settings at any time by pressing the SPEED or INCLINE buttons on the console. However, **when the next “chirp” is heard, the speed and/or incline will change to the next settings of the CD or video program.**

To stop the walking belt at any time, press the STOP button on the console. The TIME display will begin to flash. To restart the program, press the START button or the SPEED + button. After a moment, the walking belt will begin to move at 1.0 mph. **When the next “chirp” is heard, the speed and incline will change to the next settings of the CD or video program.**

When the CD or video program is completed, the walking belt will stop and the TIME display will begin to flash. Note: To use another CD or video program, press the STOP button or remove the key and go to step 1 on page 24.

**Note: If the speed or incline of the treadmill does not change when a “chirp” is heard:**

- **Make sure that the iFIT.com indicator is lit and that the TIME display is not flashing. If the TIME display is flashing, press the START button or the SPEED + button on the console.**

- **Adjust the volume of your CD player or VCR. If the volume is too high or too low, the console may not detect the program signals.**
- **Make sure that the audio cable is properly connected, that it is fully plugged in, and that it is not wrapped around a power cord.**
- **If you are using your portable CD player and the CD skips, set the CD player on the floor or another flat surface instead of on the console.**

## **6** Follow your progress with the LED displays.

See step 7 on page 14.

## **7** When the program is completed, remove the key.

See step 7 on page 16.

**CAUTION: Always remove iFIT.com CDs and videocassettes from your CD player or VCR when you are finished using them.**

## HOW TO USE PROGRAMS DIRECTLY FROM OUR WEB SITE

Our Web site at [www.iFIT.com](http://www.iFIT.com) allows you to access basic programs, audio programs, and video programs directly from the internet. Additional options are soon to be available. See [www.iFIT.com](http://www.iFIT.com) for details.

To use programs from our Web site, the treadmill must be connected to your home computer. See HOW TO CONNECT YOUR COMPUTER on page 23. In addition, you must have an internet connection and an internet service provider. A list of specific system requirements will be found on our Web site.

Follow the steps below to use a program from our Web site.

### 1 Insert the key fully into the console.

See HOW TO TURN ON THE POWER on page 12.

### 2 Select user 1, 2, or 3.

See step 2 on page 13.

### 3 Select the iFIT.com mode.

When the key is inserted, the manual mode will be selected. To use an iFIT.com CD or video program, press the MODE button repeatedly until the iFIT.com indicator lights. The letters "I FIT" and three indicators will appear in the LED matrix.

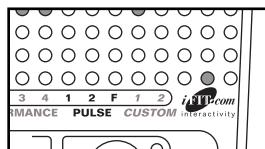

### 4 Go to your computer and start an internet connection.

### 5 Start your web browser, if necessary, and go to our Web site at [www.iFIT.com](http://www.iFIT.com).

### 6 Follow the desired links on our Web site to select a program.

Read and follow the on-line instructions for using a program.

### 7 Follow the on-line instructions to start the program.

When you start the program, an on-screen countdown will begin.

### 8 Return to the treadmill and stand on the foot rails. Find the clip attached to the key and slide the clip onto the waistband of your clothes.

When the on-screen countdown ends, the program will begin and the walking belt will begin to move. Hold the handrails, step onto the walking belt, and begin walking. During the program, an electronic "chirping" sound will alert you when the speed and/or incline of the treadmill is about to change.

**CAUTION: Always listen for the "chirp" and be prepared for speed and/or incline changes.**

If the speed or incline settings are too high or too low, you can manually override the settings at any time by pressing the SPEED or INCLINE buttons on the console. However, **when the next "chirp" is heard, the speed and/or incline will change to the next settings of the program.**

To stop the walking belt at any time, press the STOP button on the console. The TIME display will begin to flash. To restart the program, press the START button or the SPEED + button. After a moment, the walking belt will begin to move at 1.0 mph. **When the next "chirp" is heard, the speed and incline will change to the next settings of the program.**

When the program is completed, the walking belt will stop and the TIME display will begin to flash. Note: To use another program, press the STOP button and go to step 5.

**Note: If the speed or incline of the treadmill does not change when a "chirp" is heard, make sure that the iFIT.com indicator is lit and that the TIME display is not flashing. In addition, make sure that the audio cable is properly connected, that it is fully plugged in, and that it is not wrapped around a power cord.**

### 9 Follow your progress with the LED displays.

See step 7 on page 14.

### 10 When the program is completed, remove the key.

See step 7 on page 16.

# HOW TO FOLD AND MOVE THE TREADMILL

## HOW TO FOLD THE TREADMILL FOR STORAGE

Before folding the treadmill, adjust the incline to the lowest position. If this is not done, the treadmill may be permanently damaged. Next, unplug the power cord. **CAUTION: You must be able to safely lift 45 pounds (20 kg) in order to raise, lower, or move the treadmill.**

1. Hold the treadmill with your hands in the locations shown at the right. **CAUTION: To decrease the possibility of injury, bend your legs and keep your back straight. As you raise the treadmill, make sure to lift with your legs rather than your back.** Raise the treadmill about halfway to the vertical position.

2. Move your right hand to the position shown and hold the treadmill firmly. Hold the lock knob with your left hand and pull it to the side. Raise the treadmill until the lock knob is aligned with the catch. Slowly release the lock knob. **Make sure that the pin on the lock knob is inside of the catch.**

**To protect the floor or carpet from damage, place a mat under the treadmill. Keep the treadmill out of direct sunlight. Do not leave the treadmill in the storage position in temperatures above 85° Fahrenheit.**

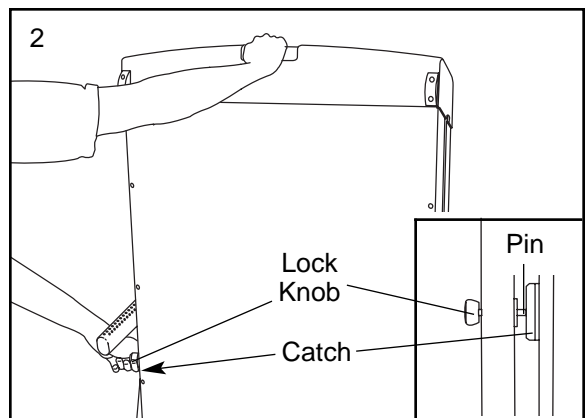
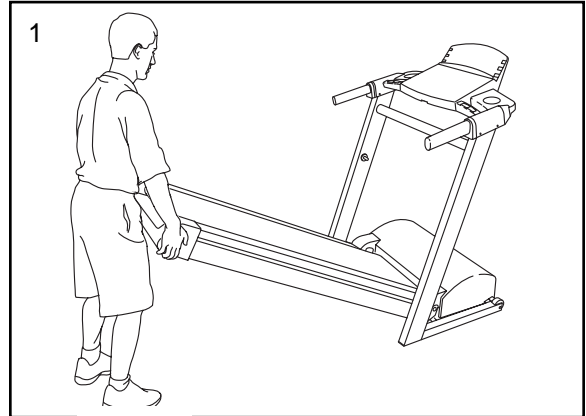

## HOW TO MOVE THE TREADMILL

Before moving the treadmill, convert the treadmill to the storage position as described above. **Make sure that the pin on the lock knob is inside of the catch.**

1. Hold the handrails as shown and place one foot against the hood **only in the location shown. Do not hold or push on the book holder or it may be damaged.**
2. Tilt the treadmill back until it rolls freely on the front wheels. Carefully move the treadmill to the desired location. **Never move the treadmill without tipping it back. To reduce the risk of injury, use extreme caution while moving the treadmill. Do not move the treadmill over an uneven surface.**
3. Place one foot on the base and carefully lower the treadmill until it is resting on the base.

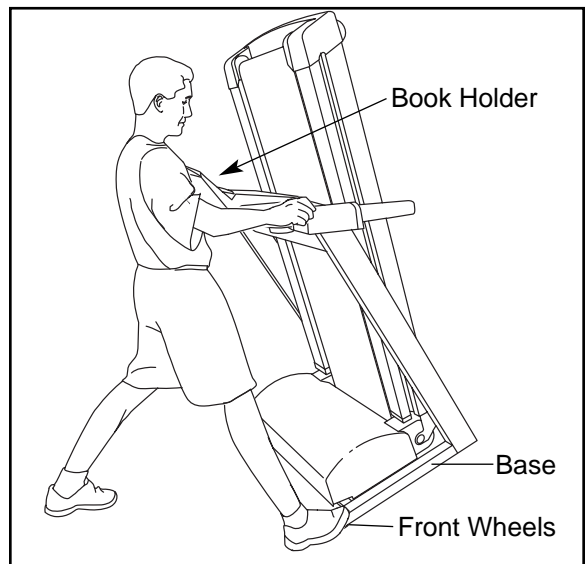

## HOW TO LOWER THE TREADMILL FOR USE

1. See drawing 2 above. Hold the upper end of the treadmill with your right hand as shown. Using your left hand, pull the lock knob to the left and hold it. Pivot the treadmill down until the frame is past the pin on the lock knob. Note: You may need to push the handrail to the side slightly.
2. See drawing 1 above. Hold the treadmill firmly with both hands, and lower the treadmill to the floor. Do not drop the treadmill **CAUTION: To decrease the possibility of injury, bend your legs and keep your back straight.**

# TROUBLESHOOTING

Most treadmill problems can be solved by following the steps below. Find the symptom that applies, and follow the steps listed. If further assistance is needed, please call our Customer Service Department toll-free at 1-800-999-3756, Monday through Friday, 6 a.m. until 6 p.m. Mountain Time (excluding holidays).

## PROBLEM: The power does not turn on

**SOLUTION:** a. Make sure that the power cord is plugged into a surge suppressor, and that the surge suppressor is plugged into a properly grounded outlet (see page 9). Use only a single-outlet surge suppressor that meets all of the specifications described on page 9. Important: The treadmill is not compatible with GFCI-equipped outlets.

b. After the power cord has been plugged in, make sure that the key is fully inserted into the console.

c. Check the reset/off circuit breaker located on the frame near the power cord. If the switch protrudes as shown, the circuit breaker has tripped. To reset the circuit breaker, wait for five minutes and then press the switch back in.

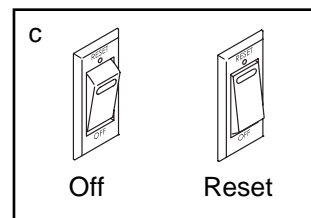

## PROBLEM: The power turns off during use

**SOLUTION:** a. Check the reset/off circuit breaker located on the treadmill near the power cord (see c. above). If the circuit breaker has tripped, wait for five minutes and then press the switch back in.

b. Make sure that the power cord is plugged in. If the power cord is plugged in, unplug it, wait for five minutes, and then plug it back in.

c. Remove the key from the console. Reinsert the key fully into the console.

d. Make sure that the reset/off circuit breaker is in the on position (see d. above).

e. If the treadmill still will not run, please call our Customer Service Department, toll-free.

## PROBLEM: The walking belt slows when walked on

**SOLUTION:** a. Use only a single-outlet surge suppressor that meets all of the specifications described on page 9.

b. If the walking belt is overtightened, treadmill performance may decrease and the walking belt may become damaged. Remove the key and **UNPLUG THE POWER CORD**. Using the allen wrench, turn both rear roller adjustment bolts counterclockwise 1/4 of a turn. When the walking belt is properly tightened, you should be able to lift each side of the walking belt 3 to 4 inches off the walking platform. Be careful to keep the walking belt centered. Plug in the power cord, insert the key, and run the treadmill for a few minutes. Repeat until the walking belt is properly tightened.

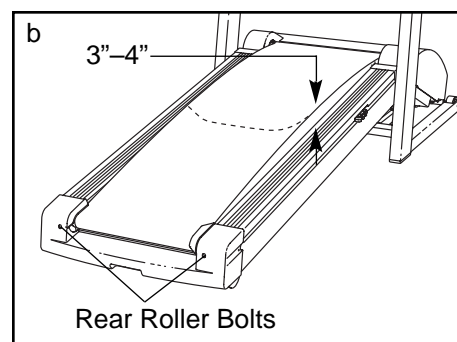

c. If the walking belt still slows when walked on, please call our Customer Service Department, toll-free.

**PROBLEM: The walking belt is off-center or slips when walked on**

**SOLUTION:** a. If the walking belt is off-center, first remove the key and **UNPLUG THE POWER CORD**. If the walking belt has shifted to the left, use the allen wrench to turn the left rear roller bolt clockwise 1/2 of a turn; if the walking belt has shifted to the right, turn the left bolt counterclockwise 1/2 of a turn. Be careful not to overtighten the walking belt. Plug in the power cord, insert the key, and run the treadmill for a few minutes. Repeat until the walking belt is centered.

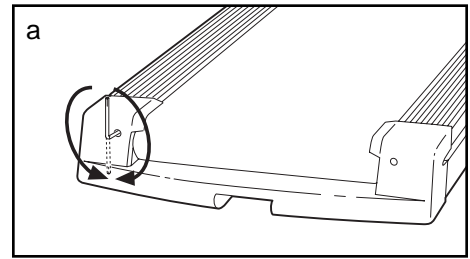

b. If the walking belt slips when walked on, first remove the key and **UNPLUG THE POWER CORD**. Using the allen wrench, turn both rear roller bolts clockwise, 1/4 of a turn. When the walking belt is correctly tightened, you should be able to lift each side of the walking belt 3 to 4 inches off the walking platform. Be careful to keep the walking belt centered. Plug in the power cord, insert the key, and carefully walk on the treadmill for a few minutes. Repeat until the walking belt is properly tightened.

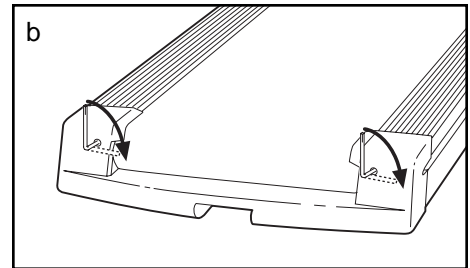

**PROBLEM: The Speed/Minutes-Mile display on the console does not function properly**

**SOLUTION:** a. Remove the key from the console and **unplug the power cord**. Remove the screws from the hood and carefully remove the hood. Locate the Reed Switch (17) and the Magnet (12) on the left side of the Pulley (11). Turn the Pulley until the Magnet is aligned with the Reed Switch. **Make sure that the gap between the Magnet and the Reed Switch is about 1/8"**. If necessary, loosen the Screw (66) and move the Reed Switch slightly. Retighten the Screw. Re-attach the hood and run the treadmill for a few minutes to check for a correct speed reading.

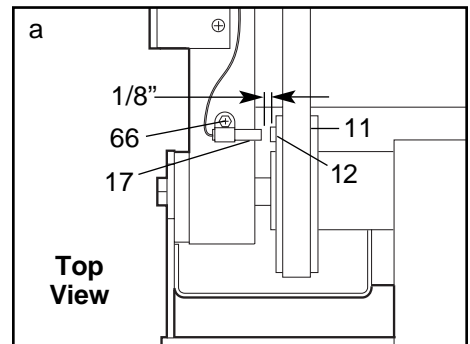

**PROBLEM: The heart rate monitor does not function properly**

**SOLUTION:** a. If the heart rate monitor does not function properly, see HEART RATE MONITOR TROUBLESHOOTING on page 7.

b. If the heart rate monitor still does not function properly, the battery should be changed. To replace the battery, locate the battery cover on the back of the sensor unit. Insert a coin into the slot in the cover and turn the cover counterclockwise to the "open" position. Remove the cover.

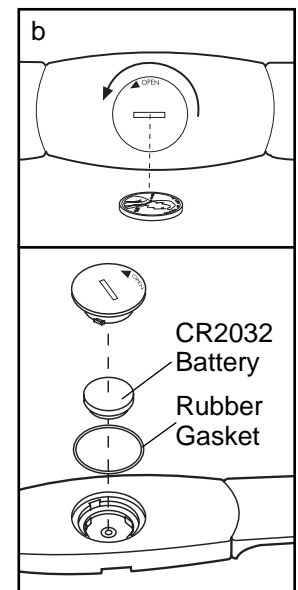

Next, remove the old battery from the sensor unit. Insert a new **CR 2032 battery**, making sure that the writing is on top. In addition, make sure that the rubber gasket is in place in the sensor unit. Replace the battery cover and turn it to the closed position.

**PROBLEM: The displays and indicators on the console remain lit after the key is removed**

**SOLUTION:** a. Hold down the STOP button while inserting the key into the console.

**Make sure that there is not a letter “d” in the CALS/FAT CALS display.** If a “d” appears in the display, the console is in the “demo” mode. This mode is intended to be used only when a treadmill is displayed in a store. When the console is in the demo mode, the power cord can be plugged in, the key can be removed from the console, and the displays and indicators on the console will automatically light in a preset sequence, although the buttons on the console will not operate. **If a “d” appears in the CALS/FAT CALS display, press the SPEED – button so the display is blank.** Then, remove the key from the console.

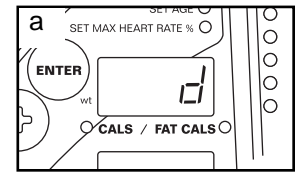

# REEBOK UNIVERSITY

Reebok University was launched in 1993 to fulfill a vision to establish a “university without walls” that develops quality, researched, state-of-the-art fitness programming for the fitness industry throughout the world.

Working with the world's best professionals, Reebok University has created a host of original programs, such as Step Reebok<sup>®</sup>, Walk Reebok<sup>SM</sup>, Slide Reebok<sup>SM</sup> and Reebok City Jam<sup>SM</sup>. The industry has adopted Reebok programming as the “gold” standard. Our guidelines and terminology are used by fitness professionals and participants around the world, and our exceptional programming has been approved in the United States by AFAA and ACE for continuing education credits.

## WALKING AND CARDIORESPIRATORY ENDURANCE

Scientific studies confirm that walking at a moderate to brisk pace can enhance aerobic fitness. Rippe and his colleagues<sup>1</sup> found that of 500 subjects tested, 67% of the men and 90% of the women were able to reach their target heart rates by walking 4 to 4.5 miles per hour.

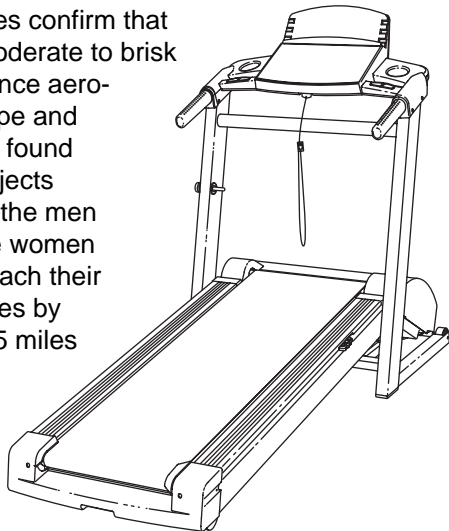

Pollock and his colleagues<sup>2</sup> found that middle-aged men who walked at a pace of 3.5 to 4.5 miles per hour for 40 minutes four times per week had the same cardiovascular improvements as men the same age who jogged for 30 minutes three times per week. Although the intensity of exercise was lower for the walkers than the runners, the increased duration and frequency of walking provided the walkers with similar aerobic benefits as the runners.

On the basis of current research, it seems clear that walking at a moderate to brisk pace can be an excellent aerobic activity.

## WALKING AND REDUCED RISK FOR CARDIOVASCULAR DISEASE

Several studies have found that regular walking at any speed can increase HDL-C cholesterol (a high-density lipoprotein which removes excess cholesterol from the body) and can lower concentrations of blood triglycerides (a storage form of fat), thus reducing the risk for cardiovascular disease.

Duncan and his colleagues<sup>3</sup> concluded that exercise does not have to be vigorous to reduce cardiovascular risk factors. In other words, people who choose to stroll rather than walk briskly can reduce their risk for cardiovascular disease.

After studying the physical activity patterns of 17,000 Harvard alumni over a 20-year period, Paffenbarger and his colleagues<sup>4</sup> concluded that walking as little as five city blocks per day can reduce the risk of cardiovascular disease, and walking 2 miles per day can reduce the risk of a heart attack by 28% or more. Therefore, while walking at a fast pace will improve aerobic fitness, walking at any speed (slow or fast) can reduce a person's risk for heart disease.

## WALKING AND WEIGHT REDUCTION

Walking is an excellent activity for burning calories. The steeper the incline and/or the faster the speed, the more calories are burned. For example, a 150-pound person walking at 3.5 miles per hour on flat ground will burn about 300 calories per hour. This same person will burn 400 calories per hour on a gentle 4% incline and 500 calories per hour on a steeper 10% incline. If this person speeds the pace up to 4 miles per hour on level ground, 350 calories will be burned in one hour.<sup>5</sup>

It should be noted that participants who do not wish to walk at faster speeds can burn a comparable number of calories by walking for longer periods of time.

## WALKING AND BONE DENSITY

Osteoporosis is a major health problem in the United States, affecting an estimated 15 to 30 million people. An age-related disorder, osteoporosis reduces the density of bones. This disease can be life-threatening since many older people die as a result of complications suffered from broken bones. Adequate calcium in the diet and weight-bearing exercises seem to reduce the risk of osteoporosis.

Several studies have reported that regular walking at moderate to brisk speeds appears to increase bone density. Specifically, Fradin and his colleagues<sup>6</sup> found that 70-year-old subjects who walked at least 30 minutes per day had higher bone mineral content than subjects who walked less than 30 minutes per day. Jones and his colleagues<sup>7</sup> reported that sedentary women (aged 30 to 61 years old) who began a regular walking program and continued for one year increased their bone density.

Since walking can be comfortably performed by people of any age, walking appears to be practical and effective in reducing a person's risk for developing osteoporosis.

### **WALKING AND STRESS REDUCTION**

There are many stressors in today's society, including economic concerns, work-related pressures and the need to balance career goals with home responsibilities. People who are unable to cope with these types of stressors are often tense and anxious, and may even become physically or psychologically ill.

Researchers have found that exercise is one way to help people reduce stress. For example, subjects who engaged in a regular aerobic conditioning program and who altered their diets experienced significant gains in self-concept, feelings of well-being and reduced depression.<sup>8</sup>

Cramer and his colleagues<sup>9</sup> specifically examined the effect of brisk walking on mildly obese sedentary women and found that walking improved general psychological well-being. Walking therefore appears to be an effective tool for improving psychological well-being.

### **WALKING AND INJURIES**

Walking is often associated with a low injury rate. Walking is considered to be a "low impact" activity because one foot remains in contact with the ground at all times. Walking at speeds of 3 miles per hour produces vertical impact forces that are around 1.25 times body weight, whereas running at 7 miles per hour increases vertical impact forces to more than 2.5 times body weight.

During a 24-week study, not one of 59 participants who walked five days a week at speeds between 3 and 5 miles per hour sustained a walking-related injury that necessitated consulting with a physician. Carroll and his colleagues<sup>10</sup> reported that 14% of the elderly subjects participating in a walking study suffered training-related orthopedic injuries, mostly to the lower leg and foot. The majority of injuries occurred in the group assigned to "fast walking."

It is important to note that all forms of exercise have some degree of risk associated with the activity. Generally, the less mechanical stress on the musculoskeletal system, the less risk of becoming injured. Because of the low-impact nature of walking, the incidence of injury appears to be low when compared to other high-impact activities.

### **REFERENCES**

1. Rippe, J., Ross, J., et. al. "Cardiovascular effects of walking." (Abstract), Proceedings of the Second International Conference on Physical Activity, Aging and Sports, July, 1985, p. 47.
2. Pollock, M., Miller, H. Jr., et. al. "Effects of walking on body composition and cardiovascular function of middle-aged men." *Journal of Applied Physiology*, 1971, 30:126-130.
3. Duncan, J., Gordon, N., et. al. "Women walking for health and fitness. How much is enough?" *Journal of the American Medical Association*, 1991, 266(23):3295-9.
4. Paffenbarger, R., Hyde, R., et.al. "Physical activity, all-cause mortality and longevity of college alumni." *New England Journal of Medicine*, 1986, 314:605-613.
5. "Better walking workouts." *University of California at Berkeley Wellness Letter*, 1992, 8(12):4-5.
6. Fradin, K. Grimby, G., et. al. "Walking habits and health-related factors in a 70-year-old population," *Gerontology*, 1991, 37(5):281-8.
7. Jones, P., Hardman, A., et. al. "Influence of brisk walking on the broadband ultrasonic attenuation of the calcaneus in previously sedentary women aged 30-61 years." *Calcified Tissue International*, 1991, 49(2):112-5.
8. Blair, S., Collingwood, T., et. al. "Health Promotion for Educators: Impact on Health Behaviors, Satisfaction, and General Well-Being," *American Journal of Public Health*, 1984, 74:147-49.
9. Cramer, S., Nieman D., et. al. "The effects of moderate exercise training on psychological well-being and mood state in women." *Journal of Psychosomatic Research*, 1991, 35(4-5):437-49.
10. Carroll, J., Pollack, M., et. al. "Incidence of injury during moderate and high intensity walking in the elderly." *Journal of Gerontology*, 1992, 47(3):M61-6.



# EXERCISE GUIDELINES

**⚠️ WARNING:** Before beginning this or any exercise program, consult your physician. This is especially important for individuals over the age of 35 or individuals with pre-existing health problems.

The heart rate monitor is not a medical device. Various factors, including the user's movement, may affect the accuracy of heart rate readings. The heart rate monitor is intended only as an exercise aid in determining heart rate trends in general.

The following guidelines will help you to plan your exercise program. For more detailed exercise information, obtain a reputable book or consult your physician.

## EXERCISE INTENSITY

Whether your goal is to burn fat or to strengthen your cardiovascular system, the key to achieving the desired results is to exercise with the proper intensity. The proper intensity level can be found by using your heart rate as a guide. The chart below shows recommended heart rates for fat burning and aerobic exercise.

	165	155	145	140	130	125	115
♥	145	138	130	125	118	110	103
♥	125	120	115	110	105	95	90
	20	30	40	50	60	70	80

To find the proper heart rate for you, first find your age near the bottom of the chart (ages are rounded off to the nearest ten years). Next, find the three numbers above your age. The three numbers define your "training zone." The lower two numbers are recommended heart rates for fat burning; the higher number is the recommended heart rate for aerobic exercise.

You can measure your heart rate using the heart rate monitor.

### Fat Burning

To burn fat effectively, you must exercise at a relatively low intensity level for a sustained period of time.

During the first few minutes of exercise, your body uses easily accessible *carbohydrate calories* for energy. Only after the first few minutes does your body begin to use stored *fat calories* for energy. If your goal is to burn fat, adjust the speed or incline of the treadmill until your heart rate is near the lowest number in your training zone.

For maximum fat burning, adjust the speed or incline of the treadmill until your heart rate is near the middle number in your training zone.

### Aerobic Exercise

If your goal is to strengthen your cardiovascular system, your exercise must be "aerobic." Aerobic exercise is activity that requires large amounts of oxygen for prolonged periods of time. This increases the demand on the heart to pump blood to the muscles and on the lungs to oxygenate the blood. For aerobic exercise, adjust the speed or incline of the treadmill until your heart rate is near the highest number in your training zone.

## WORKOUT GUIDELINES

Each workout should include the following three parts:

**A Warm-up**—Start each workout with 5 to 10 minutes of stretching and light exercise. A proper warm-up increases your body temperature, heart rate and circulation in preparation for exercise.

**Training Zone Exercise**—After warming up, increase the intensity of your exercise until your heart rate is in your training zone for 20 to 60 minutes. (During the first few weeks of your exercise program, do not keep your heart rate in your training zone for longer than 20 minutes.) Breathe regularly and deeply as you exercise—never hold your breath.

**A Cool-down**—Finish each workout with 5 to 10 minutes of stretching to cool down. This will increase the flexibility of your muscles and will help prevent post-exercise problems.

## EXERCISE FREQUENCY

To maintain or improve your condition, complete three workouts each week, with at least one day of rest between workouts. After a few months, you may complete up to five workouts each week if desired.

# PART LIST—MODEL NO. RBTL15830

R1103A

To locate the parts listed below, see the EXPLODED DRAWING attached in the center of this manual.

Key No.	Qty.	Description	Key No.	Qty.	Description
1	2	Foot Rail Insert	51	1	Heart Rate Strap
2	2	Foot Rail	52	2	Roller Adj. Washer
3	1	Audio Wire	53	2	Rear Roller Adjustment Bolt
4	2	Isolator	54	1	Rear Endcap
5	1	Latch Catch	55	1	Frame
6	1	Platform	56	1	Allen Wrench
7	4	Walking Platform Screw	57	2	Rear Platform Screw
8	1	Walking Belt	58	1	Rear Roller
9	2	Frame Pivot Bolt	59*	1	Idler Assembly
10	4	Frame Pivot Washer	60	1	Audio Wire Nut
11	1	Front Wheel/Pulley	61	2	Roller Star Washer
12	1	Magnet	62	1	Foam Grip (left)
13	9	Front Roller Nut/Front Wheel Nut	63	1	Idler Arm
14	2	Spacer Insert	64	1	Idler Spring
15	2	Frame Pivot Spacer	65	1	Upright
16	1	Reed Switch Clip	66	25	Console Screw
17	1	Reed Switch	67	1	Lock Knob
18	1	Lift Frame	68	1	Lock Knob Sleeve
19	1	Motor Isolator Plate	69	1	Lock Knob Spring
20	1	Pulse Receiver Wire	70	1	Lock Pin Collar
21	2	Front Endcap	71	1	Pin Clip
22	1	Motor Belt	72	1	Lock Pin
23	1	Pulse Receiver	73	3	Incline Pivot Bolt/Tension Bolt
24	1	Motor	74*	1	Latch Assembly
25	1	Reading Rack	75	8	Console Screw (long)/Upright Screw
26	4	Controller Screw	76	2	Wheel Spacer
27	4	Hood Bracket	77	2	Front Wheel
28	1	Ground Wire	78	2	Wheel Bolt
29	1	Incline Motor Bolt (Bottom)	79	1	Pulley Nut
30	2	Rear Endcap Screw	80	1	Console Base (Top)
31	1	Lift Motor Bolt	81	1	Console
32	2	Motor Bolt	82	1	Key/Clip
33	1	Outlet Bracket	83	2	Right Pad
34	4	Plastic Stand-off	84	4	Belly Pan Screw
35	1	Power Supply	85	1	Upright Wire Harness
36	1	Transformer	86	1	Shock
37	1	Controller	87	2	Upright Endcap
38	2	Base Endcap Screw	88	2	Left Pad
39	1	Motor Hood	89	1	Filter Wire
40	5	Hood Screw	90	1	Latch Warning Decal
41	1	Motor Belly Pan	91	1	Incline Motor
42	2	Belt Guide	92	1	Motor Controller Wire
43	14	Screw	93	1	Controller Bracket
44	13	Plastic Fastener	94	1	Console Base/Switch (bottom)
45	1	Frame Belly Pan	95	2	Tie Holder
46	1	Idler Arm Nylon Washer	96	1	Tie
47	2	Motor Isolator	97	5	8" Cable Tie
48	2	Rear Foot	98	2	Bumper
49	2	Isolator Washer	99	2	Bumper Screw
50	2	Isolator Nut	100	1	Idler Pulley Bolt

Key No.	Qty.	Description	Key No.	Qty.	Description
101	1	Reset/Off Circuit Breaker	114	1	Foam Grip (right)
102	1	Power Cord	115	2	Ball Detent
103	1	Power Cord Grommet	116	2	Adjustable Cushion
104	2	Warning Decal	117	2	Cushion Spacer
105	1	Heart Rate Sensor	118	2	Cushion Bolt
106	1	Adapter	119	2	Cushion Plate
107	1	iFIT.com Audio Cable	#	1	8" Blue Wire, 2 F
108	4	Rear Foot Screw	#	1	4" Blue Wire, 2 F
109	1	Pulley Washer	#	1	User's Manual
110	1	Idler Pulley			
111	1	Pulley Spacer			
112	2	Outlet Bracket Star Washer			* Includes all parts shown in the box
113	2	Static Decal			# These parts are not illustrated

## HOW TO ORDER REPLACEMENT PARTS

To order replacement parts, call our Customer Service Department toll-free at 1-800-999-3756, Monday through Friday, 6 a.m. until 6 p.m. Mountain Time (excluding holidays). To help us assist you, please be prepared to give the following information:

- The MODEL NUMBER of the product (RBTL15830)
- The NAME of the product (REEBOK® V 4500 treadmill)
- The SERIAL NUMBER of the product (see the front cover of this manual)
- The KEY NUMBER and DESCRIPTION of the part(s) (see the PART LIST on page 34 and this page and the EXPLODED DRAWING attached in the center of this manual).

# EXPLODED DRAWING—MODEL NO. RBTL15830

R1103A

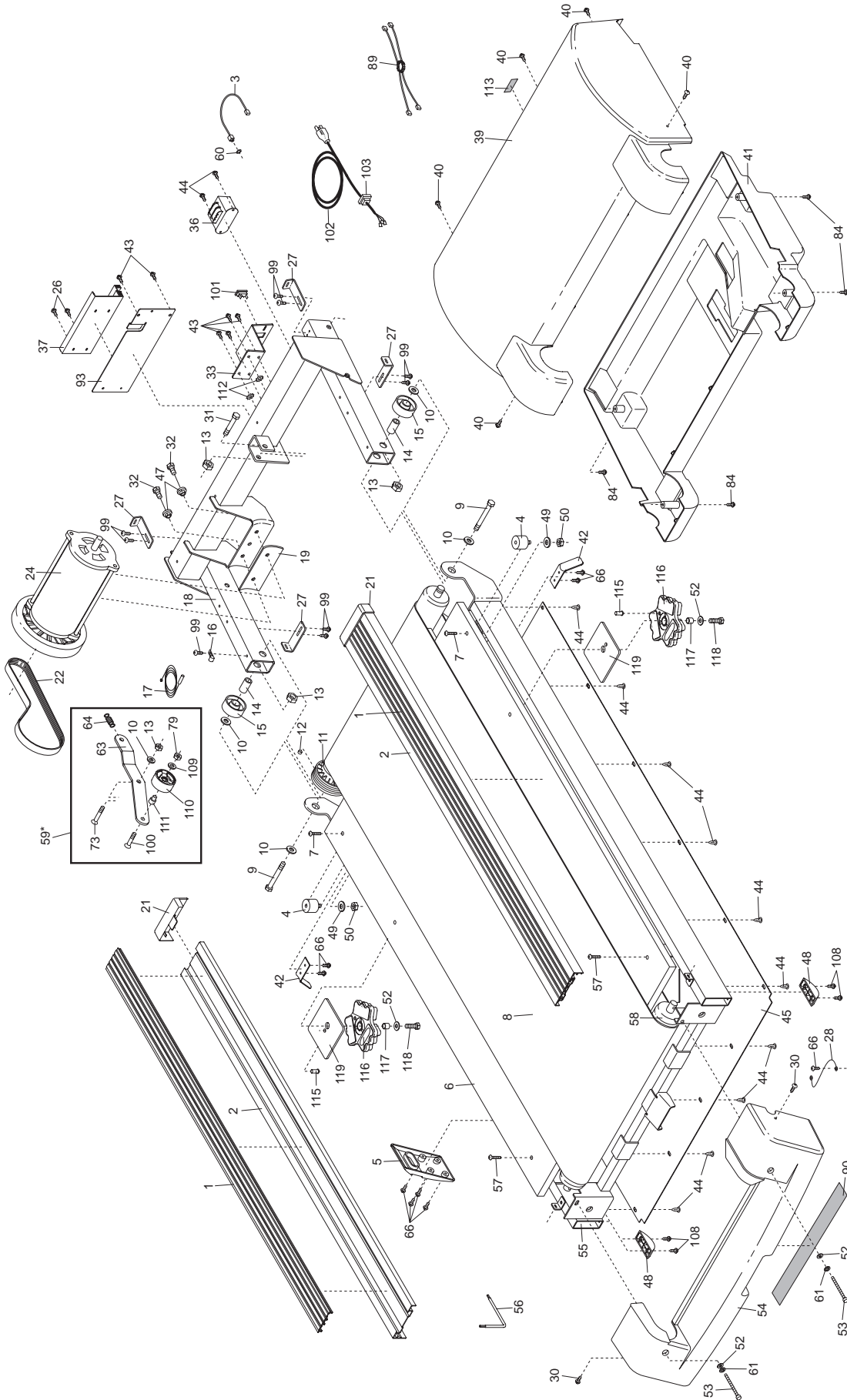

# EXPLODED DRAWING—MODEL NO. RBTL15830

R1103A

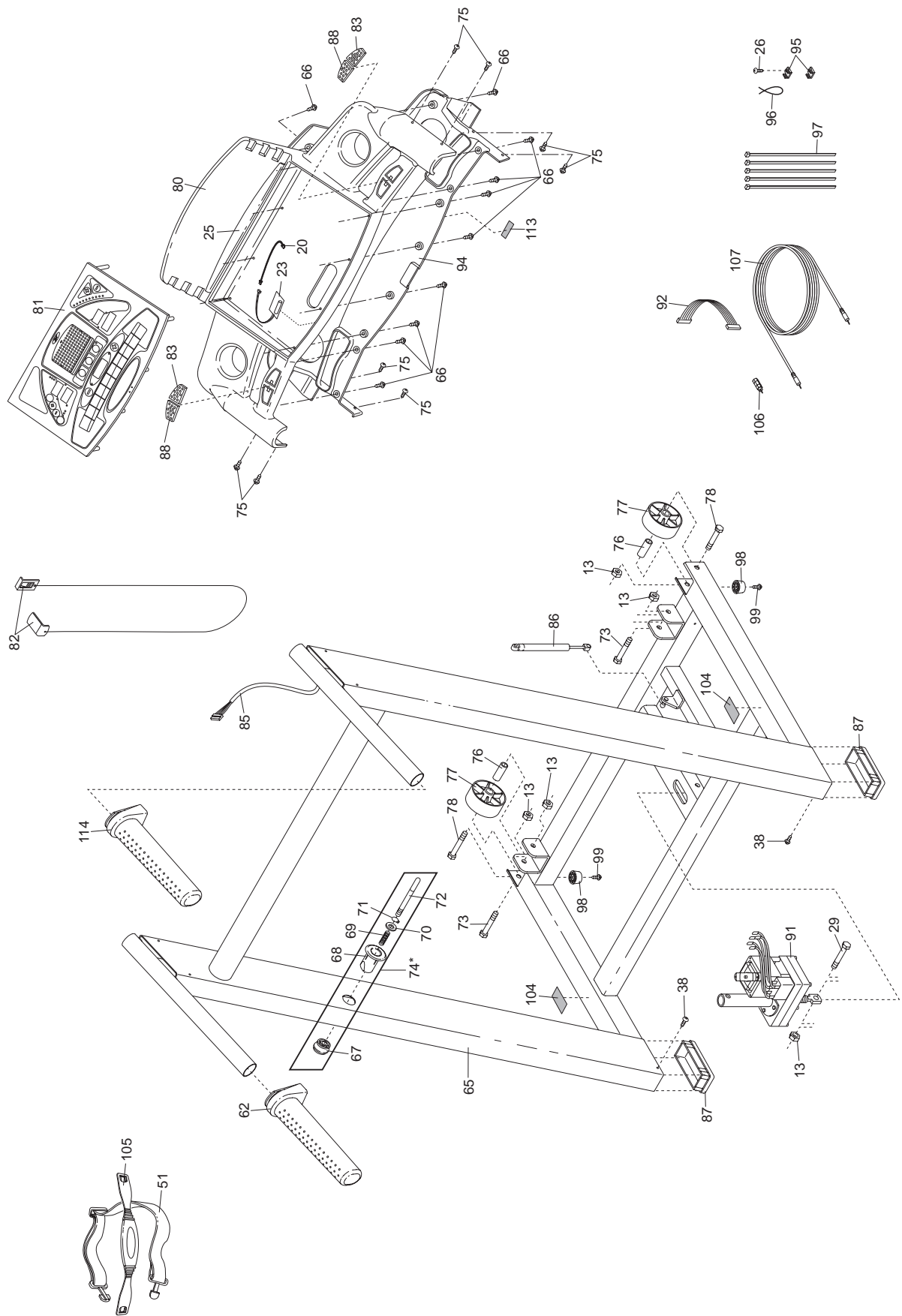

# LIMITED WARRANTY

**WHAT IS COVERED**—The entire REEBOK® V 4500 ("Product") is warranted to be free of all defects in material and workmanship.

**WHO IS COVERED**—The original purchaser or any person receiving the Product as a gift from the original purchaser.

**HOW LONG IS IT COVERED**—ICON Health & Fitness, Inc. ("ICON"), warrants the frame for a lifetime. The motor for ten years after the date of purchase. The belt and deck are covered for two years after the date of purchase. All mechanical components are covered for two years after the date of purchase. All electrical components are covered for two years after the date of purchase. Labor is covered for one year.

**WHAT WE DO TO CORRECT COVERED DEFECTS**—We will ship to you, without charge, any replacement part or component, providing the repairs are authorized by ICON first and are performed by an ICON trained and authorized service provider, or, at our option, we will replace the Product.

**WHAT IS NOT COVERED**—Any failures or damage caused by unauthorized service, misuse, accident, negligence, improper assembly or installation, alterations, modifications without our written authorization or by failure on your part to use, operate, and maintain as set out in your User's Manual ("Manual").

**WHAT YOU MUST DO**—Always retain proof of purchase, such as your bill of sale; store, operate, and maintain the Product as specified in the Manual; notify our Customer Service Department of any defect within 10 days after discovery of the defect; as instructed, return any defected part for replacement or, if necessary, the entire product, for repair.

**USER'S MANUAL**—It is VERY IMPORTANT THAT YOU READ THE MANUAL before operating the Product. Remember to do the periodic maintenance requirements specified in the Manual to assure proper operation and your continued satisfaction.

**HOW TO GET PARTS AND SERVICE**—Simply call our Customer Service Department at 1-800-999-3756 and tell them your name and address and the serial number of your Product. They will tell you how to get a part replaced, or if necessary, arrange for service where your Product is located or advise you how to ship the Product for service. Before shipping, always obtain a Return Authorization Number (RA No.) from our Customer Service Department; securely pack your Product (save the original shipping carton if possible); put the RA No. on the outside of the carton and insure the product. Include a letter explaining the product or problem and a copy of your proof of purchase if you believe the service is covered by warranty.

ICON is not responsible or liable for indirect, special or consequential damages arising out of or in connection with the use or performance of the product or damages with respect to any economic loss, loss of property, loss of revenues or profits, loss of enjoyment or use, costs of removal, installation or other consequential damages of whatsoever nature. Some states do not allow the exclusion or limitation of incidental or consequential damages. Accordingly, the above limitation may not apply to you.

The warranty extended hereunder is in lieu of any and all other warranties and any implied warranties of merchantability or fitness for a particular purpose is limited in its scope and duration to the terms set forth herein. Some states do not allow limitations on how long an implied warranty lasts. Accordingly, the above limitation may not apply to you.

No one is authorized to change, modify or extend the terms of this limited warranty.

This warranty gives you specific legal rights and you may have other rights which vary from state to state.

**ICON HEALTH & FITNESS, INC., 1500 S. 1000 W., LOGAN, UT 84321-9813**